

**CONTEXTUAL ADVERTISING: MATCHING CONTENTS WITH
POTENTIAL VIEWERS**

By

Muhamad Rizuan b Mohamed Arifin

Dissertation submitted in partial fulfillment of
the requirements for the
Bachelor of Technology (Hons)
(Business Information System)

JAN 2013

Universiti Teknologi PETRONAS
Bandar Seri Iskandar,
31750 Tronoh
Perak Darul Ridzuan

CERTIFICATION OF APPROVAL

**CONTEXTUAL ADVERTISING: MATCHING CONTENTS WITH
POTENTIAL VIEWERS**

by

Muhamad Rizuan b Mohamed Arifin

A project dissertation submitted to the
Business Information System Programme
Universiti Teknologi PETRONAS
in partial fulfillment of the requirement for the
BACHELOR OF TECHNOLOGY (Hons)
(BUSINESS INFORMATION SYSTEM)

Approved by,

(Mr Ahmad Izuddin B Zainal Abidin)

**UNIVERSITI TEKNOLOGI PETRONAS
TRONOH, PERAK**

January 2013

CERTIFICATION OF ORIGINALITY

This is to certify that I am responsible for the work submitted in this project, that the original work is my own except as specified in the references and acknowledgements, and that the original work contained herein have not been undertaken or done by unspecified sources or persons.

Muhamad Rizuan Mohamed Arifin

ABSTRACT

Advertisement is the form of information use by the company to deliver marketing messages to attract potential customers. Matching the right content in the right place is important in managing online advertising. The matching content tool is used in the advertising company to insure the online advertisement that display in the viewer screen are matched to the information that searched. Viewers will feel comfortable with the right advertise content that really compliment their needs. The advertisement attracts the viewer to buy the product and service that advertiser offer. This made advertiser achieved the main goal of the investment in the advertising.

This project purpose is to improve or enhance the management of the advertisement that match the viewer need and searching through the internet platform. The conventional online advertisements are display according to the bidding rate involving publisher and advertiser agreement. The project also tries to focus on optimizing revenue from matched advertising tool use in investing for online advertisement.

ACKNOWLEDGEMENTS

I would like to express my gratitude to all those who gave me the possibility to complete this final year project and report.

The special thanks go to my helpful supervisor, Mr Ahmad Izuddin B Zainal Abidin. The supervision and support that he gave truly help the progression and smoothness of the final year project course. The co-operation is much indeed appreciated.

I have furthermore to thank the final year project course coordinator who gave and confirmed this permission and encouraged me to this project. I want to thank the Department of Computer & Information Sciences (CIS) and Universiti Teknologi PETRONAS (UTP) for giving me permission to commence this report in the first instance, to do the necessary research work.

Last but not least , great appreciation goes to the rest of the people that help me from time to time during the industry internship course. The whole task and activities really brought us together to appreciate the true value of friendship and respect of each other.

LIST OF FIGURES

Title	Page
Figure 1.0: Relation participants (user, publisher, advertiser, ads exchange) in online ads ecology.	02
Figure 2.0: Example of Sponsored Search Ads, Branding Ads and Contextual Ads	06
Figure 3.0: Online advertising matching criteria listed	10
Figure 3.1: Set of web page and advertisement	11
Figure 3.2: Development flow of the project .	13
Figure 3.3: Main frame system of online advertising	16
Figure 3.4: Class Diagram of online advertising system	22
Figure 3.5: Flow Diagram of ads server system	23
Figure 3.6: Draft of web interface for main frame .	24
Figure 3.7: observation chart of advertising display use key word “car	27
Figure 3.8: observation chart of advertising display use key word “health”.	28
Figure 3.9: observation chart of advertising display use key word “health” after cache is clean	28

LIST OF TABLES

Title	Page
Table 2.0: Element of the branding ads, sponsored search ads and contextual ads.	07
Table 3.0 : Ghantt chart and project milestone for FYP1	18
Table 3.1 : Ghantt chart and project milestone for FYP2	19
Table 3.2 : Server base modal criteria	20

ABBREVIATIONS AND NOMENCLATURES

ROI	Return of Investment
Ads	Advertisement
OTC	Over the counter

TABLE OF CONTENT

Title	Page
ABSTRACT	i
LIST OF FIGURE	ii
LIST OF TABLE	iii
CHAPTER 1: INTRODUCTION	01-04
1.1 Background of Study	01
1.2 Problem Statement	03
1.3 Objectives and Scope of Study	04
CHAPTER 2: LITERATURE REVIEW.	05-08
2.1 Online Advertisements (Ads).	05
2.2 Trading Places.	07
2.3 Optimize in Online Advertising.	08
CHAPTER 3: METHODOLOGY	10-25
3.1 Method	10
3.2 Rapid Application Development (RAD)	13
3.3 Project Architecture	15
3.4 Data Collection.	24
3.5 Data Analysis.	25
CHAPTER 4: CONCLUSION AND RECOMMENDATIONS	30-31
4.1 Conclusion	30
4.2 Recommendations.	31
REFERENCES.	32-33
APPENDICES.	34
Appendix 1.0: Internet Advertising User Interface	
Appendix 2.0: Technical Paper	

CHAPTER 1

INTRODUCTION

1.1 Background of Study

Advertisement is the form of information use by companies to deliver marketing messages to attract potential customers. Previous advertising medium such as television, billboard, radio and newspaper is used in delivering the message as an advertisement (ad). Current technology has changed the way of ads that are displayed in the web page based. In the report “The Effects Of Online Advertising” by Mccoys et al (2007) quoted that online ads figure has grown from year to year according to the statistic and figure compared to the other medium. Additionally, this phenomena happen related to the marketing strategies play by company that need a good return of investment (ROI) with the specific potential target market.

Today, internet become the main platform for users to find and changing information in their daily life. This gives online ads is the alternative opportunities to advertiser in promoting the good and service to targeted user that needed the good or service. Online ads ecosystem relationships involve four main players that are publisher, customer (user), advertiser, and ad exchange (Yuan et al,2012). Figure 1 shows the relation between publisher, customer(user), advertiser and ad exchange in online ads ecology. An **advertiser** needs a space on the web to place its marketing message in term of ads and sponsored search form. Advertiser investment made to ensure the end participation (user) in online ads get the information about the product and service provided by advertiser. This gives a high ROI to advertiser's company through revenue made from user buys and subscribing.

Publisher is a hosts websites person that finds the specific space to display the message from the advertiser to the targeted user. The publisher received the investment and reserve space for display ads according to the agreement with the advertiser. An **ads exchange** is a mechanism that facilitates the bid buying and selling of online media advertising inventory from multiple ad networks. Ads exchange work as a middle person that manage the needed of advertiser to display the advertisement. Connection from many publishers give ads exchange advantage to provide a better advertisement display for broad target market. A web **user** is participation that is targeted by the advertiser and publisher to display the marketing message. User data behaviors are used by publisher to know the suitable advertisement to the potential target market. User purchasing and subscribing is a revenue that advertisers gain after investing on advertisement tool. The revenue gain can be used by advertiser for the next cycle in online ads ecology.

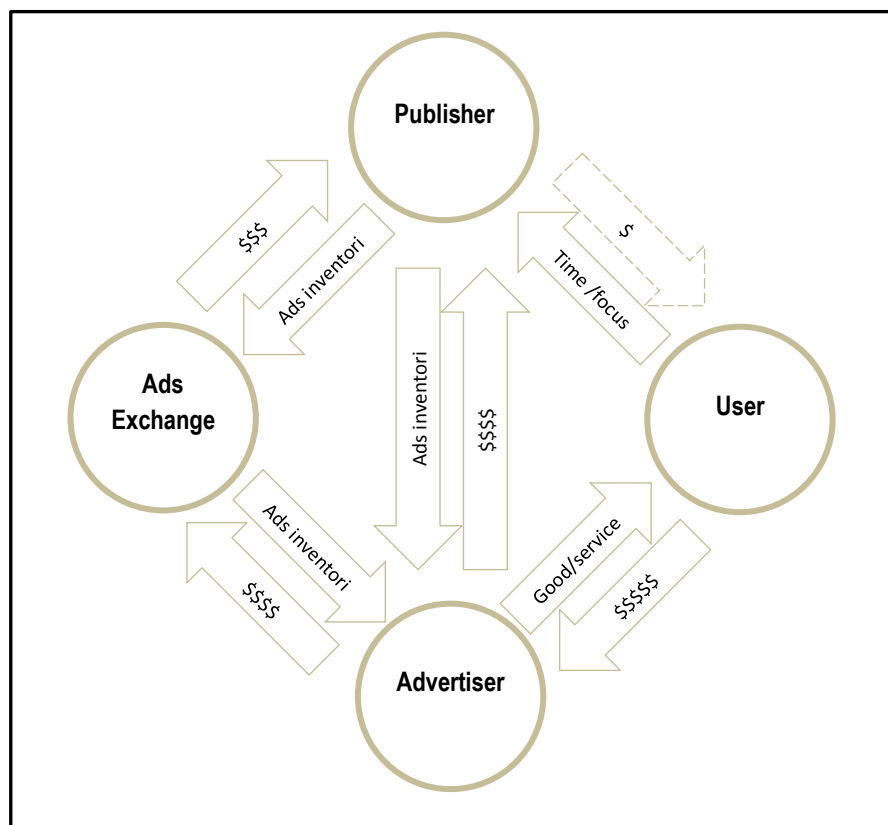

Figure 1.0: Relation participants (user, publisher, advertiser, ads exchange) in online ads ecology.

1.2 Problem Statement

From a marketing point of view, demand for advertisement is high. This will generate online advertisement service grown and an advantage to the publisher or the ad exchange in term of profit reason also connection with the advertiser's company. Online ads are introducing early were found to be effectively in creating brand awareness and positive attitudes. Recently, online advertising has been described as nonsensical, uninformative, forgettable, ineffective, and intrusive (Mccoy et al). In the same report Mccoy et al say that 69% of the pop-up ads are annoying and 23% of them will not return to the web cause of the ads. This gives a bad perspective to advertisement industry and indirectly to the company that investing (advertiser).

Matching the right content in the right place is important in managing online ads. The match content tool is used in the advertising company to insure the online ads that display in the viewer screen are matched to the information that searched.

Since the types of ads that grown require computation and a principled way of finding the best match between a particular user in a specified context and available ads, the online ads concept in other term is a computational advertisement. Yuan et al (2012) in the report about "Internet Advertising: An Interplay among Advertisers, Online Publishers, Ad Exchanges and Web Users" explain the fastest growing of online ads in recent years has been seen as an involvement of scientific research areas such as microeconomics, information retrieval, statistical modelling, machine learning and recommender systems. The report also explains the best match is not limited to the ` relevant from the traditional informational but also includes the relation of the best revenue from the economic perspective on determining the ads match decision making.

The project paper is focusing on enhancing the online advertising contents matching to potential viewers from the previous method that apply. Conventional online advertising company managing the advertisement contents according to the advertiser bidding phase of the page that related. Current practice shown that the content of advertisements on the page is not delivered and receive to potential viewers.

1.3 Objectives of study

Online advertising has improved from the first time this type advertisement is introduced until now. The improvement is made in delivering the ads contents method to ensure effective deliverable advertising on the page. Several approaches are used to ensure the effectiveness of the content. The project paper is published to recognize specific contents matching tool to it's specification location base on the advertisement contents. This paper also explains the current practice matching tool especially in ads and sponsor search. Advantage and disadvantage are compared to knowing the differences in each tool from the publisher point of view in the online ads ecology.

On top of that, the main point project paper is performing enhancing to the specific contents matching tool for each advertisement contents. Enhancement that made are effected in the organizing system of the advertised ads display in the webs.

CHAPTER 2

LITERATURE REVIEW

2.1 Online Advertisement (Ads)

In today`s modern world, many of the online ads developing to complement the need of the market. Yuan et al (2012) in the report explains the main three types of online ads, sponsored search ads, branding ads and contextual ads are differentiated based on the targeting viewer and the contract of the ads (figure-2.0).

Web site searching engines like Google generate result list base on the keyword that search by user. The same concept applies to **sponsored search ads**, advertiser are buys the key word that related to the queries that user search. Sponsored search ads are displayed with the search engine result as a sponsored search. Li Chen (2008) uses Keyword search advertisement which refers to advertisements that appear side by side with search results on the search engine like Google web pages similar to the sponsored search ads. **Branding ads** are used by advertiser to display the advertisement to all visitors of the web page. The advertiser buys the space base on Over the counter (OTC) contract and campaign that have a broad target market.

On the other hand, **contextual ads** are maximizing utilization in advertising opportunities base on the visitor characteristics like geographic, language and other. Figure-2.1 shows the contextual ads that match with visitor characteristic in term of the geographic, language and key word in the web page. Additionally, the concept of the online ads can refer to the table-2.1 developed by Yuan et al (2012) that describe element for each online ads.

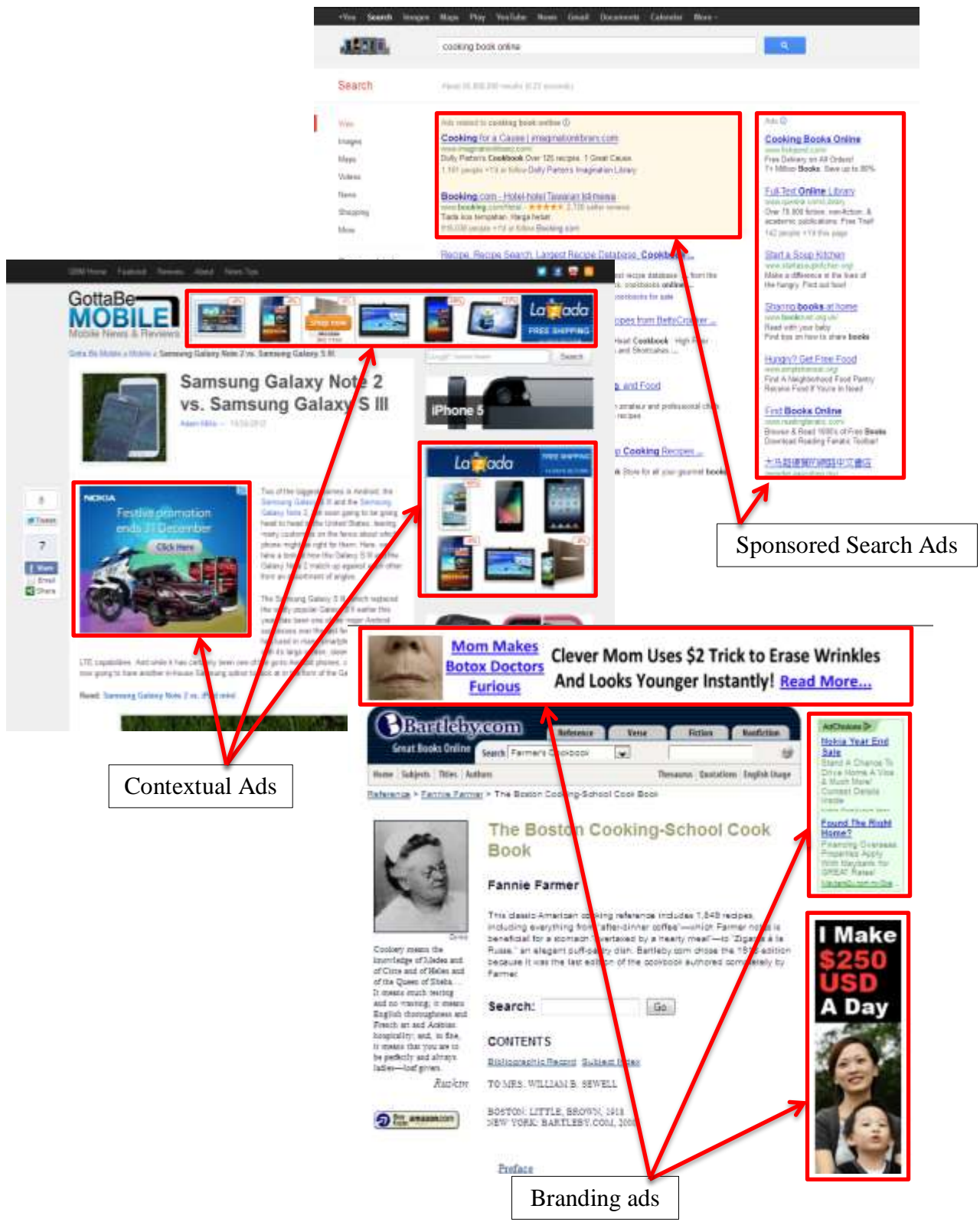

Figure 2.0: Example of Sponsored Search Ads, Branding Ads and Contextual Ads

	Branding Ads	Sponsored Search ads	Contextual ads
Seller	Large content provider	Search engine	All websites
Buyer	Large company	All companies and individually	
Contract	Long-term, large scale	Flexible	
Targeting	None	Queries and Personally Identifiable Information (PII)	Context and PII
Ads asset	Fixed slots on web pages	Top and side banners in search result page	Flexible

Table 2.0: Element of the branding ads, sponsored search ads and contextual ads.

2.2 Trading Places

The implementation of the online ads usually done by direct private negotiation or open negotiation involve bidding process in the transparent market. The contracts agreed by advertisers and publishers, or between ad networks, are long term with large volume; on the contrary. Differently if advertising opportunities are traded in transparent markets, the trading units are usually small (e.g. 1k impressions), although the total number of impressions for the advertising campaign could be huge.

Previous research done by Yung and Jhih (2008) prove that small advertisers with lower branding power would prefer contextual ads than display ads (branding ads), whereas top advertisers with stronger branding power would prefer display ads than contextual ads. In addition, according to the analysis of market efficiency done, a dominant ad channel would scarify some advertisers' benefit by raising the price of display ads.

2.3 Optimize in Online Advertising

Online advertising today face with a big problem in optimization. Chen Li (2008) in the report cites the report from Dewan et al (n.d.) found a tradeoff between ads and content for websites: more ads generate more revenue but may turn viewers off. Their findings suggest that websites put fewer ads and more content, and get compensated for by future profits. Research done by Cheng (2008) regarding optimization of revenue using Advertising of perishable information with click-based revenue only comparing with a method that use site-targeted (branding) ad first and keyword search ad last view method. The main concern is to find the optimal ending time of both types of ads to maximize of the advertisers' revenue given a budget constraint.

Result on advertising of consumer information with click-base revenue method finds that lower revenue may happen after a longer advertising period. However, the rationale here is that if people lose interest in the news story faster, than keyword-ads fail to generate the expected number of clicks. However, since advertisers are charged based on clicks, the budget is consumed slower, which leads to a longer advertising period.

On the other hand, Site-ad (branding ads) meets the requirement to wildly and quickly impress the public in the early stage of the advertising period. Although keyword-ad is not an effective marketing tool at the beginning because potential customers are unfamiliar with the new product or brand, it is a cost-efficient marketing method after a certain level of awareness is achieved. Therefore, the suggestion that site-ad first and keyword-ad last might be a better strategy for advertisers. Then the question for advertisers is how to determine optimal switching time from site-ad to keyword-ad.

The ad-network model aligns the interests of the publishers, advertisers and the network. With every click from visitors will bring benefits to both the publisher by the revenue gain, and the advertiser by increasing the number of traffic to the web

page. Broder et al. (2007) in the research paper related to online advertising explain the revenue of the online advertising in giving page p , can be estimated as:

$$R = \sum_{i=1 \dots K} P(\text{click}|p, ai) \text{price}(ai, i)$$

where k is the number of ads displayed on page p and $\text{price}(ai, i)$ is the click-price of the current ad ai at position i . However, for simplicity the understanding, Broder ignore the pricing model and concentrate on finding ads that will maximize the first term of the product, that is we search for

$$\arg \max_i P(\text{click}|p, ai)$$

Furthermore it is assumed that the probability of a click for a given ad and page is determined by its relevance score with respect to the page, thus ignoring the positional effect of the ad placement on the page.

As a result, the estimating revenue shows that maximum of probability can achieve by increasing k , the number of ads displayed on the page. This number is directly proportional to the number of pages and ad position available on each page.

CHAPTER 3

METHODOLOGY

3.1 Method.

Refer the Literature reviews related to the tools that use in online advertising are analyzed to get the information on the project from the publisher point of viewers. The previous reports, research paper, journals and article are used in the literature review as a source of reading to know the development on the topic for the previous five years.

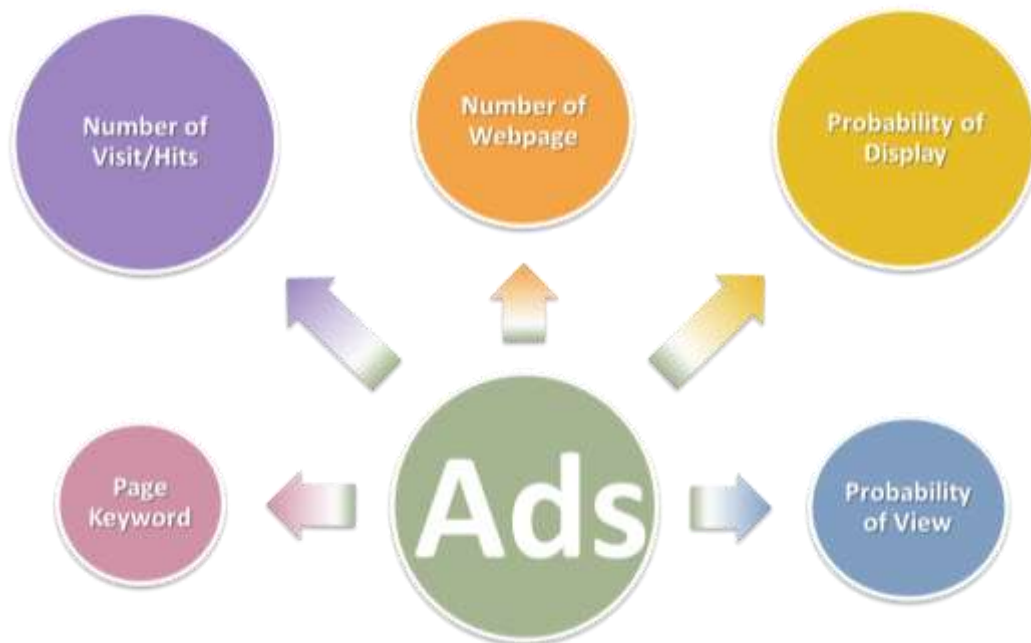

Figure 3.0: Online advertising matching criteria listed

Based on the literature review can be summaries five of the main matching criteria that is important to consider in developing a mechanism for matching tool. The first item that can be considered is the web page keyword. The Page key word is the identity of the webpage that can be used as main references to the matching mechanism in minimizing the decision making process time on the matching tool.

Other than web page key word, publisher must consider the number of the visitor hits generated from the web page. The number of visitors can be calculated based on visitors view in a period of time example per hour or per day. High number of hits can refer to the high probability that the advertisement is display and view from varies targeting visitor. The same concept use in the ads exchange which collection of publishers with the big number of pages available in a time combining the high number of hits made the advertising display is easier to accomplish by ads exchange.

Matching mechanism can be considered a tool that custom and manage advertising in the webpage slot. Different web page manages by the publisher are use in arranging the display sequential base on the matching criteria that is suggested aimed the maximizing deliverable of the advertisement.

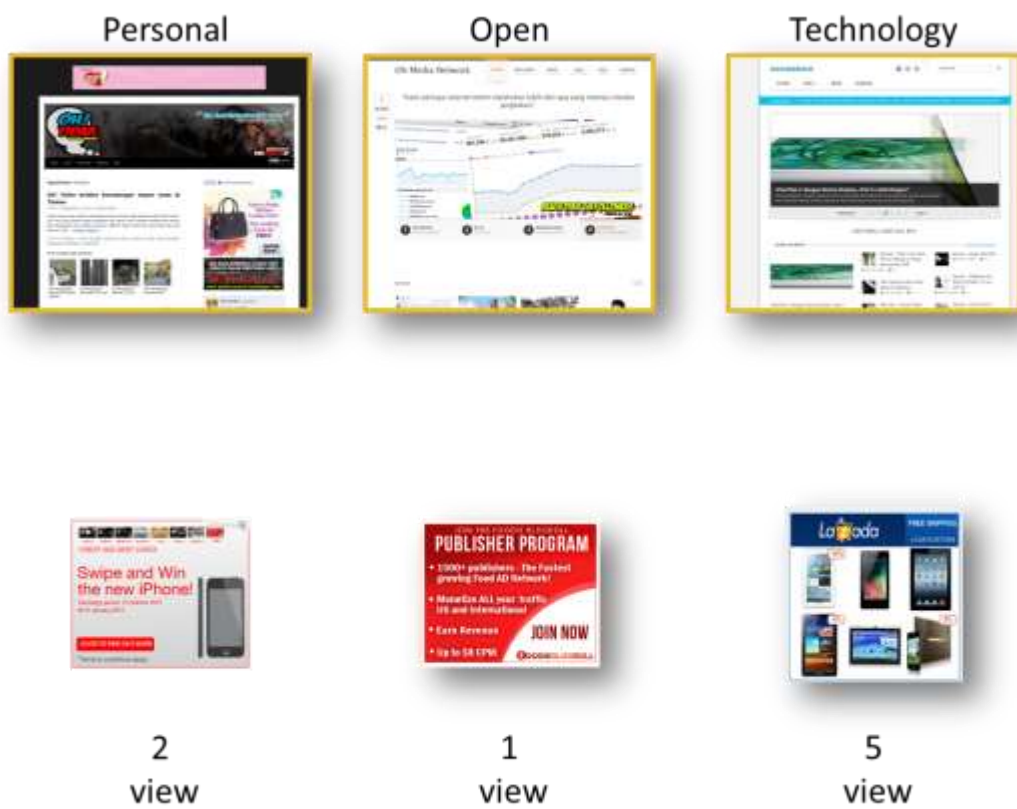

Figure 3.1: Set of web page and advertisement .

The first web page has a different theme for the content that is input in the web (figure 3.1). Comparing the second and third web page which the second web page is set as general content (Open) and third is more focusing the technology news and update (Technology). More variety of web give a variety of advertisements can be displayed by publisher. Currently in the ad inventory of the publishers have three advertisements with different target of market user and the requirement that have to be full in the time (bottom figure 3.1). The advertisers for the first advertisement require two (2) views with the target to persons that have higher spending and income (bottom left). Second advertisement is focused on web developer person that require just one (1) view only (bottom center). Third advertisement about gadget advertisement targeted for persons with gadget lover or technology savvy and high technical knowledge in the gadget (bottom right).

From the set that is built, the number if the displayed for each advertising are recorded as a data set to find the pattern of prediction and the high criteria of the advertisement influence. This data set collects and analyses as calculated using data association method. The result of the data set is generated and link in the decision tree form to see the final decision about the suitable advertisement.

The same process of record is done with commercial web pages that is randomly picked in the Google search engine. The selected key word is use to search in the Google search engine and two commercial web pages for the searching list are chosen which related to the key word use. The data set are recorded as a reference in the data analysis process.

The process is made to see the difference between the current use method compare to the matching tool that is developed. The number of matching advertising and the pattern of display sequence are analyzed for the enhancement.

3.2 Rapid Application Development (RAD)

The project development method is important to ensure the project is delivered in time given. Considering time and the amount of skill manpower limitation. The rapid application development (RAD) method is more suitable.

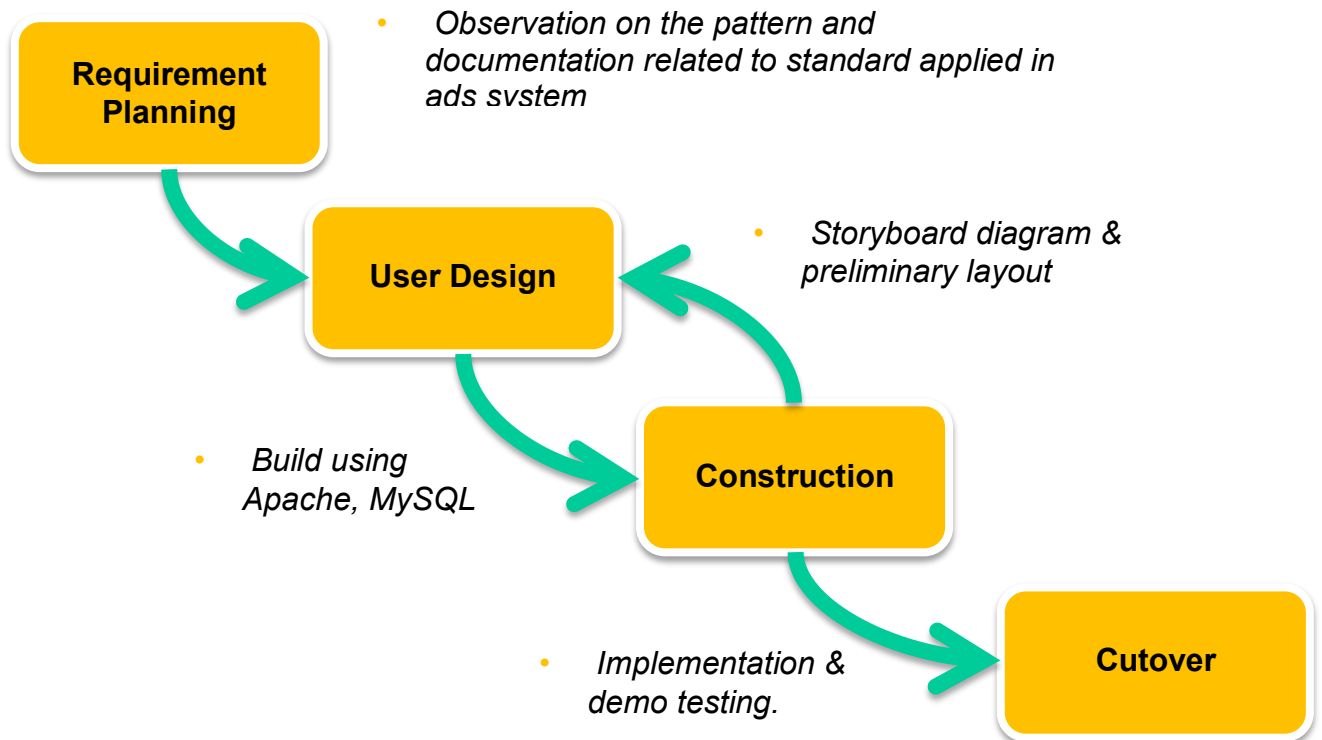

Figure 3.2: Development flow of the project .

Requirements Planning phase – combines elements of the system planning and systems analysis phases of the System Development Life Cycle (SDLC). Document analysis is done to find the system requirement of the project include hardware and software. The planning of the project development process involves two semesters. The first semester is done in final year project one (FYP 1) which system analysis and planning phase. The detail about project scope, constraints, and system

requirements are discussed to obtain a general idea about the project is all about. Second semester is involving the design construction and demo testing of the project.

User design phase – during this phase, users interact and prototype design are made that represent all system processes. The result of system analysis is combined to ensure the user interface and design are matched with the requirement. User design is a continuous interactive process to understand, modify, and eventually approve a working model of the system that meets the project needs.

Construction phase – focuses on program and application development task in the SDLC. The changes or improvements of actual the design screens or reports are continuing in this phase. This phase task is programming and application development, coding, and unit-integration.

Cutover phase – resembles the final tasks in the SDLC implementation phase, including data conversion, testing, and changeover to the new system. Compared with traditional methods, the entire process is compressed. In this phase tasks include data conversion and demo testing. As a result, the new system is built, delivered, and placed in operation much sooner

3.3 Project Architecture

A project architecture or systems architecture is the conceptual model that defines the structure, behavior, and more views of a system. System architecture that used in online advertising matching tool is a server base model system that link to the database structure. Server base model system which each computer or process on the network executed on the server and not on the client. Servers are powerful computers or processes dedicated to managing disk drives (file servers) or network traffic (network servers). Clients are PCs or workstations on which users run applications. Clients rely on servers for resources, such as files, devices, and even processing power.

The development process of the project involves the construction of the main frame in online advertising(figure 3.3). It is included the ads display that act as a webpage of publisher where the advertisement slot is located. Ads server is a server that does the selection base on the information gather from the ads display. Ad serving also performs various other tasks like counting the number of impressions/clicks for an ad campaign and report generation, which helps in determining the ROI (return of investment) for an advertiser on a ads display. The information needed by ads server include the location, previous searching keyword and the content of the ads display to analyze and match the advertising that have similar characteristics. Ads Server is requested the advertisement that is chosen from ads storage where the location of advertisement collection is stored. Ads storage is sending the advertising to sever and server is passed back the advertisement to be displayed on ads display.

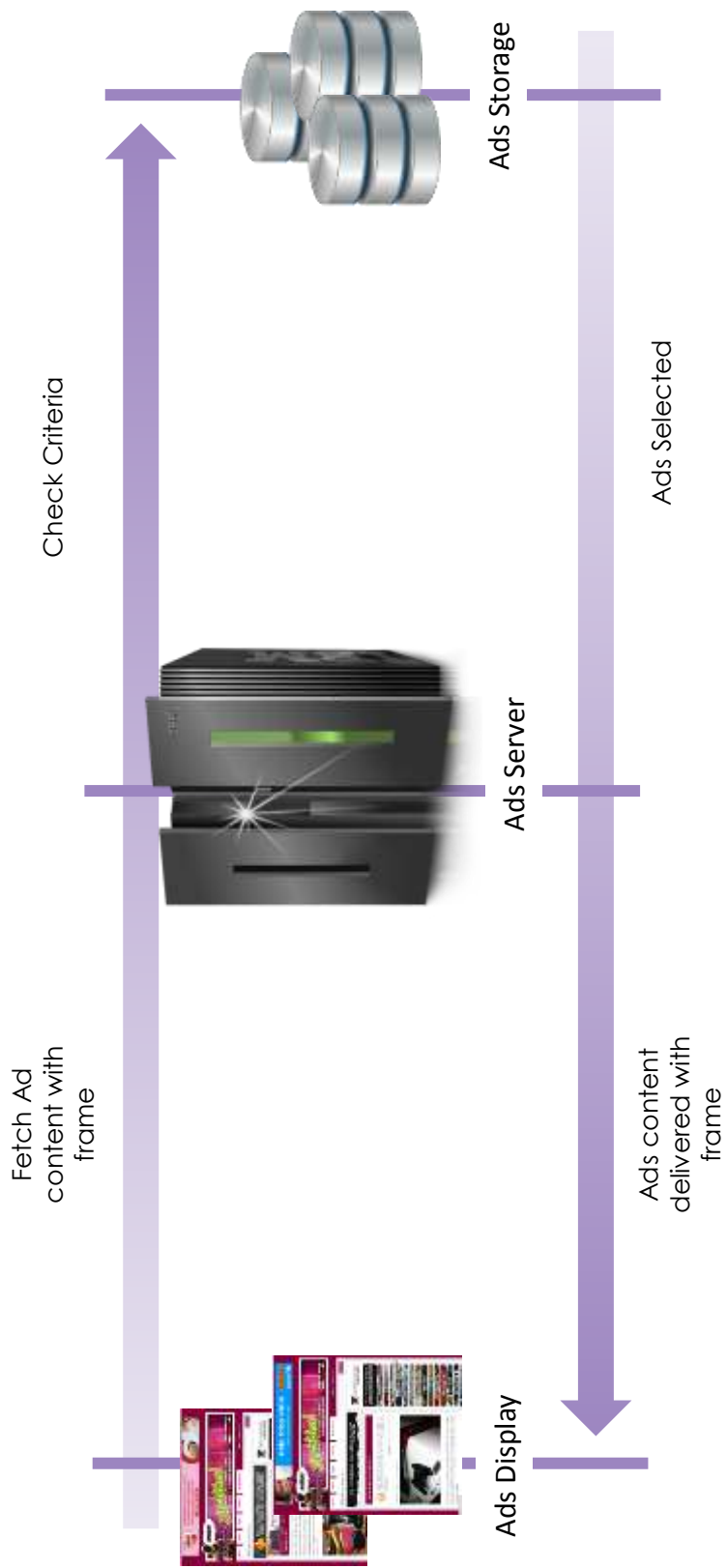

Figure 3.3 : Main frame system of online advertising

This main frame is usually applied to online advertising management. This can be done locally by the publisher's domains and the content is a control by the publishers. Third-party or remote ad servers are the method used for multiple publishers that deliver the ads from one center source and distribution of their advertisement across the ads display.

The development of the mainframe system is beginning to draft the mainframe system including the database, networking and facilities that needed (Table 3.0 & table 3.1). This is a critical stage of the main to ensure the ability of the main frame to handle the load on the system.

An architecture requirement is a formal description and representation of a system, organized in a way that supports the structure of the system which comprises system components, the externally visible properties of those components, the relationships between components and provides a plan from which components can be procured, and systems that will work together to implement the overall system. Online advertising matching tool system requirement combines of both components software and hardware. It is compulsory to ensure the system able to run and operate smoothly.

FYP I

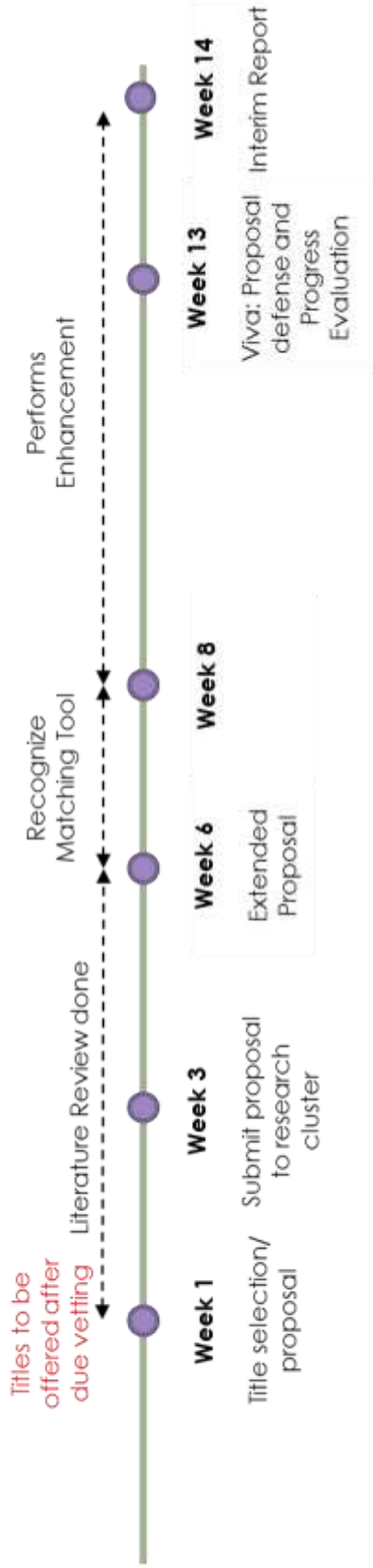

	W 01	W 02	W 03	W 04	W 05	W 06	W 07	W 08	W 09	W 10	W 11	W 12	W 13	W 14
Propose Title	[Task Bar]													
Project Analysis		[Task Bar]												
Planning			[Task Bar]											
Project draft and report									[Task Bar]					
Draft the main frame													[Task Bar]	

Table 3.0 : Gantt chart and project milestone for FYP1

FYP II

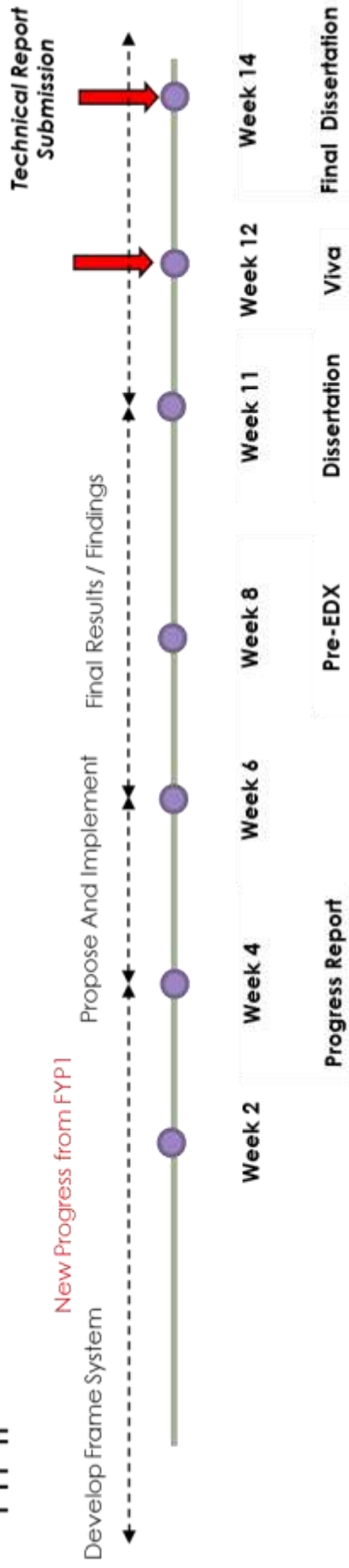

New Progress from FYP1

	W 01	W 02	W 03	W 04	W 05	W 06	W 07	W 08	W 09	W 10	W 11	W 12	W 13	W 14
	Progress Report				Pre-EDX				Dissertation		Viva	Final Dissertation		
Create interface	[Task Bar]													
Database						[Task Bar]								
Ads link														
Testing														
Documentation														

Table 3.1 : Gantt chart and project milestone for FYP2

Criteria	Sever base model system
Cost of infrastructure	Very high, because we use a lot of equipment to be connected to the Microprocessor and also a PC to store data. Meaning that, the cost of set up and build up the system is high.
Cost of development	Medium, because we just set up only in server as a intermediate. This system can be accessed in difference operation base using the web browser and no specification of program installation in other platform to access the system
Ease of development	Low, because to development applications of these architectures can be fast and painless
Interface capabilities	Low, because the systems are limited to server connection ability. The simple web interface control system uses to allow user easy to understand and operates the system
Control and security	High, because the user only controls the contents in the system by using one server. It is much easier to administer because all the data are stored in a single location.
Scalability	Low, because the systems are limited to sever ability that assigned by the system. In the other case, small setup is needed if to add extra / additional equipment to the present system

Source : Fish, R. (2012). Physical Architecture Layer Design. [presentation].
Foster School of Business, University of Washington.

Table 3.2 : Server base model criteria

3.3.1 Hardware Requirement

The most common set of requirements defined by any operating system or software application is the physical computer resources, also known as hardware. A hardware requirements list is often accompanied by a hardware compatibility list. The minimum requirements for hardware are web server, catalogue server and storage server.

Web servers can refer to either the hardware (the computer) or the software (the computer application) that helps display the system user interface that can be accessed through the Internet. The web server will cover the registration of the inventory, the order and the uploading process in the project.

Catalog data is large and complex enough to warrant a commercial database management system (DBMS) to ensure its long-term integrity and to provide the storage, organization, distribution, and data mining capabilities (Thakar, 2008). Catalog server is used to manage the database in storage server and also provides a single point of access that allows systems to centrally search for information related to the advertisement.

A file server is not intended to perform computational tasks, and does not run programs on behalf of the system. It is primarily to enable the storage and retrieval of data while the computation is carried out by the catalog server.

3.3.2 Software Requirement

Software requirement is the base or operation software that needed in running the system. One or more operating software is needed to make a system that is built fully functional. Development processes of the project need a software development kit to develop the interface for the system. The project the online advertising matching tool requires minimum software to admin the operation. This gives advantage to the publisher in monitoring the system and daily operation.

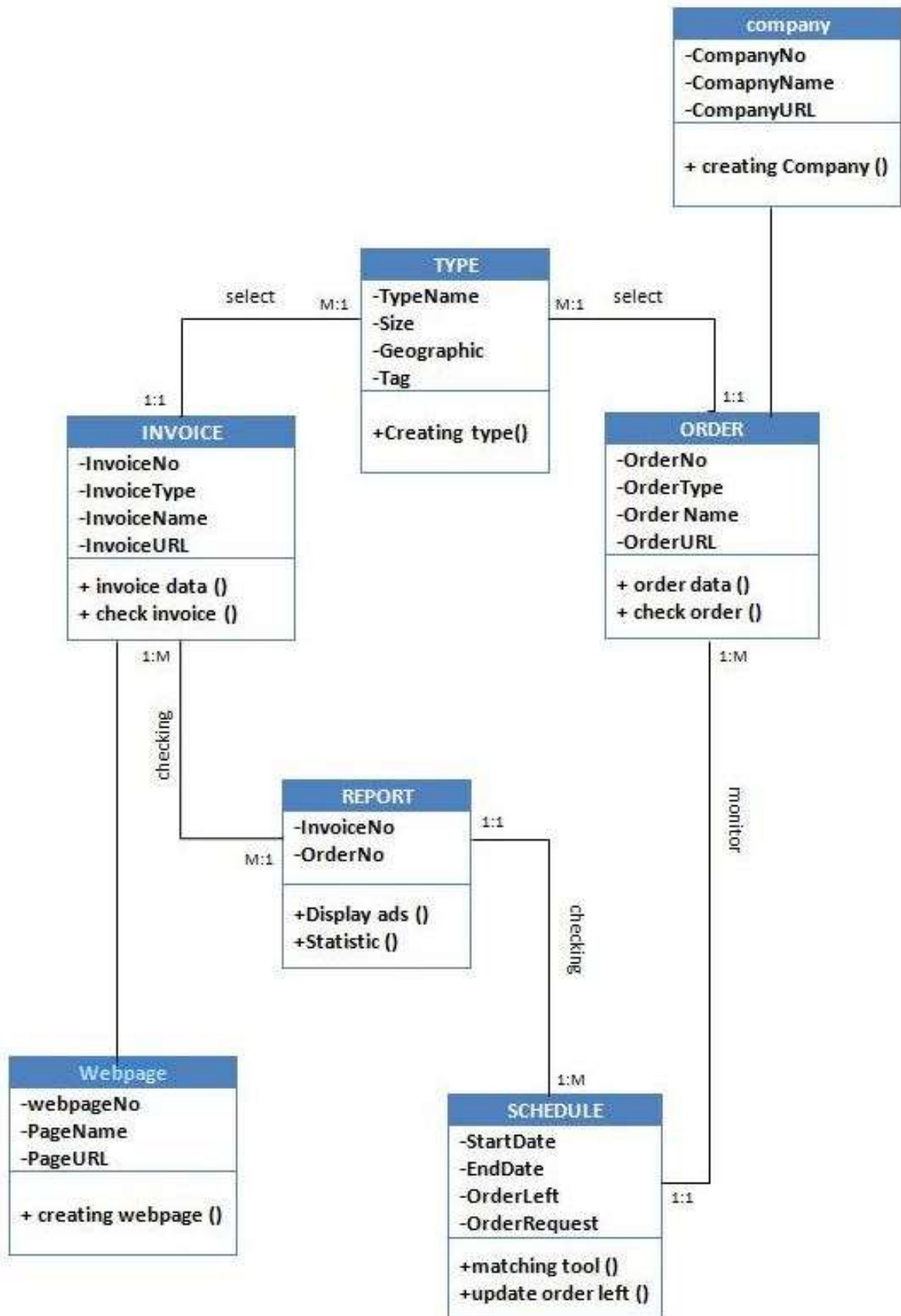

Figure 3.4 : Class Diagram of online advertising system

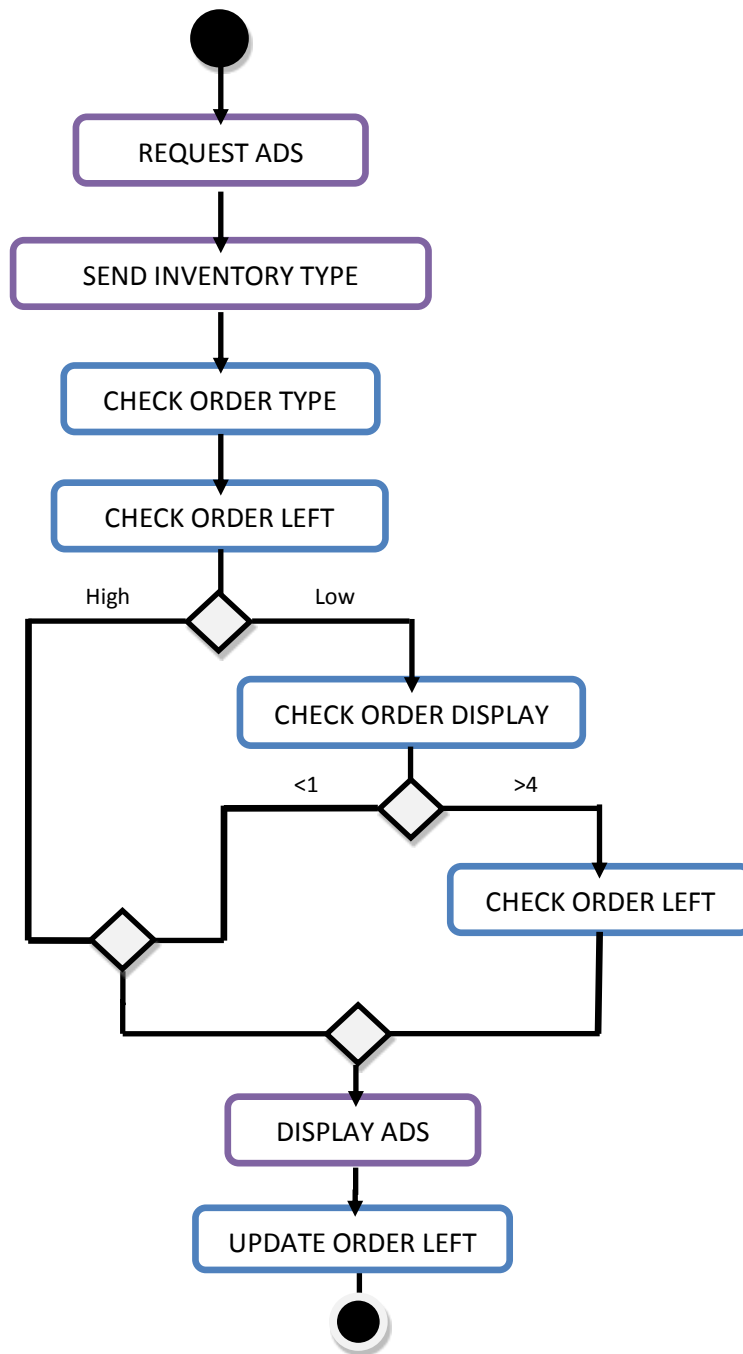

Figure 3.5 : Flow Diagram of ads server system



Figure 3.6: Draft of web interface for main frame.

3.4 Data collection.

3.4.1 Gathering Techniques

Each of the requirement-gathering techniques has strengths and weaknesses. No one technique is always better than the other and in practice most project use a combination of techniques. In general, document analysis and observation require the least amount of training.

Document Analysis

Project teams often use document analysis to understand the as-is system. Under ideal circumstances, the user that developed the existing online advertising system will have produced documentation, which was then updated by all subsequent users. In this case, the analysis can start by reviewing the documentation and examining the system is developed in the previous.

Data from the database and framework structure are analyzed to see the connection. The updated technology, articles in the literature review, document about the

existing system and facility use are analyzed to find the organization patent that will implement in the system.

Observation

Observation is done with commercial web pages that are randomly picked in the Google search engine. The selected key word is used to search in the Google search engine and three commercial web pages for the searching list are chosen which related to the key word use. The data set are recorded as a reference in the data analysis process.

The data collection is made from the prediction of number that calculated using the probabilities of advertisement on the web page. The data collection process is made based on 1) the key word use for searching, 2) number of web pages that is the use in the same key word, 3) probability of display in the same page and 4) the characteristics of advertisement display. The deference data record is used for the built web page set and data record for commercial web page.

The data collection is made based on the same ad exchange or publisher ensures the same matching method use in the deference web page. Variable like pricing method and contract are assumed fixed and the successful display is counted according to the display of the advertisement on publisher webpage.

The schedule of data set consists the four based elements that are mentioned previously. The data set collection is recorded in the schedule form and writing report for the reference on data analysis.

Combining Techniques

In practice, a requirement gathering combines a series of different techniques. Most analysis starts by using document analysis to gain an understanding of the system and the big-picture issues. From that analysis, it becomes clear whether large or small changes are anticipated. These analyses are often followed by observation of with commercial web pages to gain some understanding of the as-is system. Usually

document analysis came next after observation to gather the rest of the information needed for the as-is pictured.

From all the document analysis and observation, all the system requirements are listed to find the detail about:

1. The system that will be implemented
2. The technology that will be used
3. The equipment that is necessary
4. The advantage and disadvantages
5. The future prospects
6. The customer's needs and expectations.

3.4.2 Observation Results

The word "car" is used as a key in the Google search engine to choose the webpage that have similar content for this observation. The observation done in the sample of two publisher web pages that is chosen randomly to find the repeating number of advertising display on both web pages (www.carlilst.my and www.cbt.com.my). Both publisher web pages are related to the issues and latest technology in the car industries. Result from the observation show in the chart below (Figure 3.7).

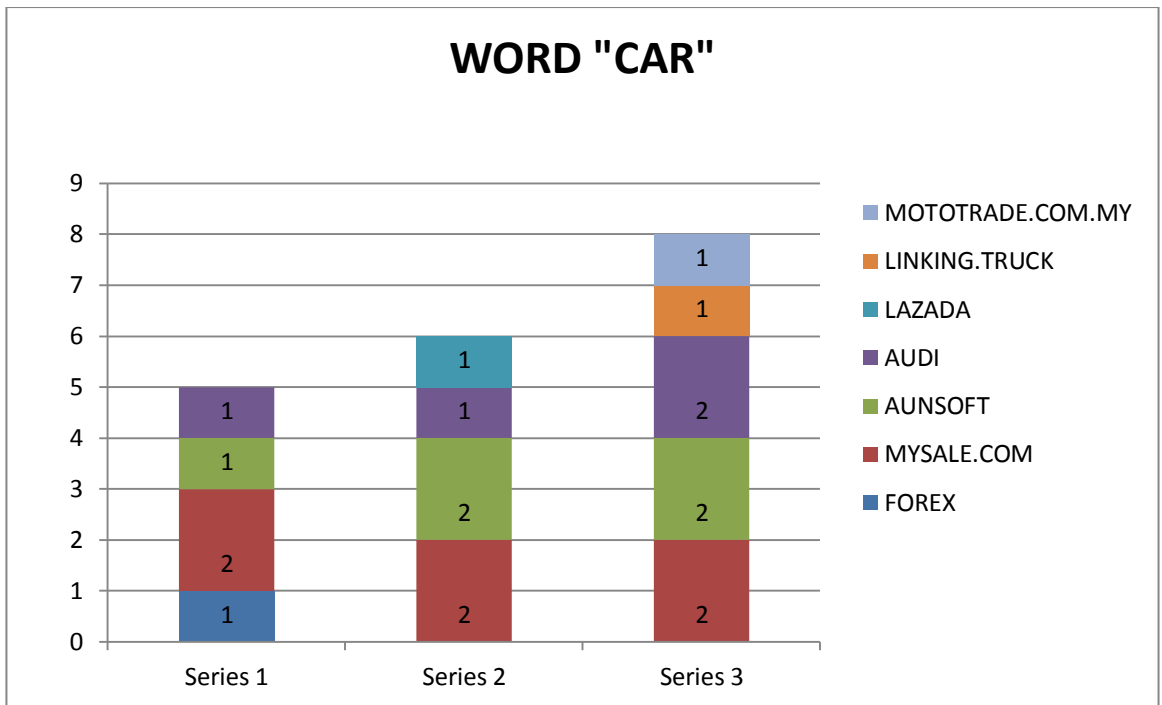

Figure 3.7 : observation chart of advertising display use key word “car”.

The word “health” is used as a key in the Google search engine to choose the webpage that have similar content for this observation. The observation done in the sample of two publisher web pages that is chosen randomly to find the repeating number of advertising display on both web pages (www.forbes.com/Health and www.telegraph.co.uk/health) . Both publisher web pages are related to the tips and information issues about the health. Result from the observation show in the chart below (Figure 3.8).

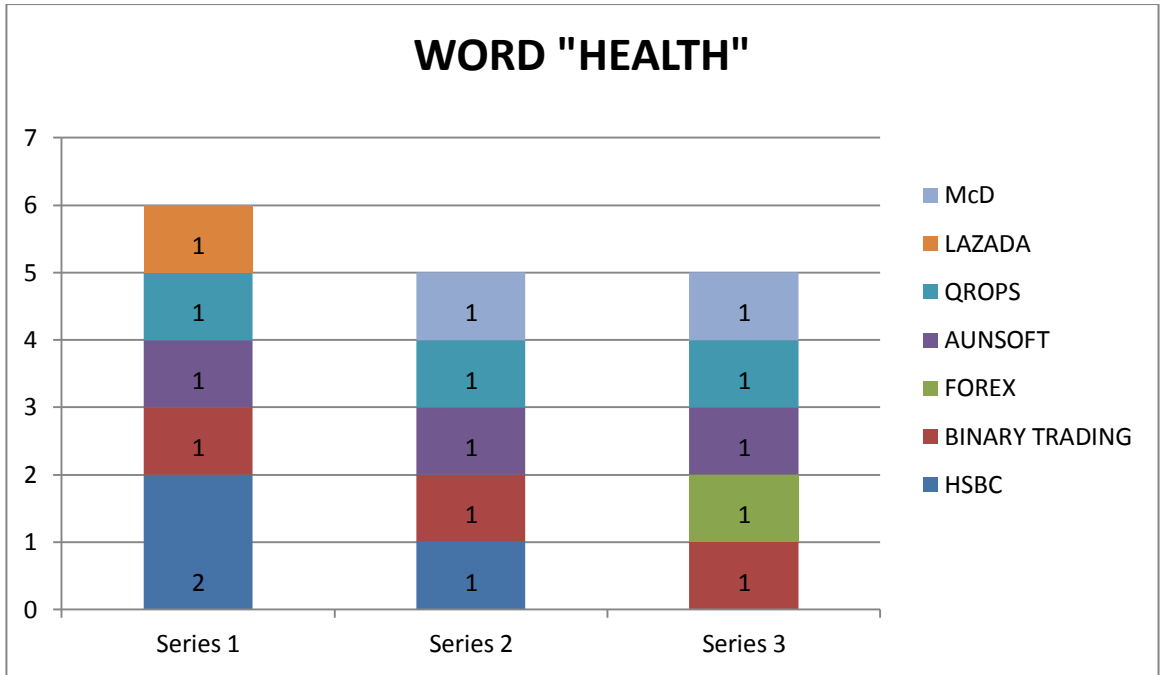

Figure 3.8 : observation chart of advertising display use key word "health".

The data are made collect after the caches of the browser are clean to analyzing the cache influence to the advertising display in the publisher webpage. The result is shown in the chart below (Figure 3.9).

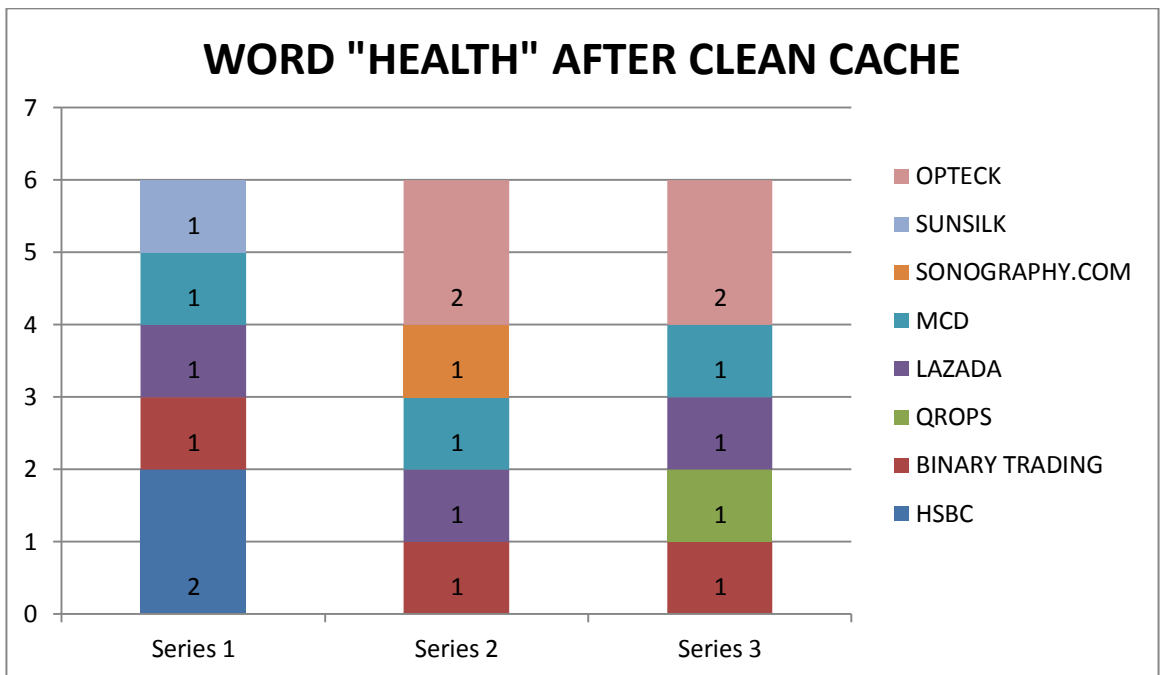

Figure 3.9 : observation chart of advertising display use key word "health" after cache is clean.

3.5 Data Analysis.

Record from the data collection is compare and analyze in term of optimization revenue and the best tools with the situation applied. The Apriori classification tree method is used to see the patterns of the decision make for suitable advertisement. An Apriori classification tree used in statistics, data mining and machine learning, as a predictive model which maps observations items to the item's target value. The generated classification tree are showing the most influence characteristic use in making advertisement decision. Both records that are collected is processed for the same step to see the final result and comparison is made to look the differences to the current commercial online ads.

The observation data collection shows that specific ads are appearing three times in the same website and majority of the ads pattern show that. The observation in the web www.carlilst.my and www.cbt.com.my show that 31 percent of the total are related to the content of the web page (figure 3.7). The similar results show from the observation done in www.forbes.com/Health and www.telegraph.co.uk/health that display 31 percent related (figure 3.8). The percentage of the appearing increasing to 61 percent after the cache or cookies of the browser is clear (figure 3.9). This is related to the influence of visitor activities in web space with the result of the ads appears.

The figure 3.8 and figure 3.9 data records that some ads are appearing in each series and not have related to the web page or key word of observation. This ads can be considered as a Branding ads. It is used by advertiser to display the advertisement to all visitors of the web page.

In other hand, from each series of the observation show that the maximum number of ads display is two. The matching tool that is set are limited to the number of the ads that appear are two. It is used to maximize the number of ads that display to the visitor .

CHAPTER 4

CONCLUSION AND RECOMMENDATIONS

4.1 Conclusion.

Online Advertising is a compliment to the traditional advertising that is previously not interactive and attractive. The global market of online advertising today involving research insure the effectiveness of online advertising to the customer. Looking for the demand on the online advertising, the number is increasing from the previous year and estimated to grow in a significant figure.

From Malaysia perspective, online advertising is in the beginning phase and have the potential to be explored. Current situation shows the new online advertising company involve Malaysian that can contribute to a more research needed for improving online advertisement in Malaysia economic.

In the future application of this project, it can be applied or adopt in a bigger scale involving the multiple publisher or ads sever network as an advertising exchange concept.

4.2 Recommendations.

This project focuses to find the best matching tool for the effective delivery of online advertising in publisher view. Future research needs to be done on the contextual advertising tool that can be implemented on the publisher system. Contextual advertising is a new field that is fast growing and needed to be explored and developed.

The development process of the project is done from the inventory and order interface which include all the database about the ads and available inventory from the website. This project in the future prospect can be combined with a pricing model system for increasing the accuracy in the decision making.

The taxonomies implementation in the semantic match of the pages and the ads is a new method apply to the internet advertising. The matching process requires that the taxonomy provides sufficient differentiation between the common commercial topics. Taxonomies implementation in online advertising needs detail research on the topic. This involves huge and real data collection from each player in the ad market environment.

REFERENCES

- Anagnostopoulos A., Broder A. Z., Gabrilovich E, Josifovski V. and Riedel L.(2007). Just-in-Time Contextual Advertising. Yahoo! Research, 2821 Mission College Blvd, Santa Clara,
- Broder A., Fontoura M., Josifovski V. and Riedel L. (2007). A Semantic Approach to Contextual Advertising. Yahoo! Research, 2821 Mission College Blvd, Santa Clara,
- Broder A., and Josifovski V. (2011). *Introduction to Computational Advertising*. [Presentation]. Stanford University.
- Chen Li. (2008). *Combining Keyword Search Advertisement and Site-Targeted Advertisement in Search Engine Advertising*. Scientific Research Publishing. From Summon Web-Scale Discovery e-database.
- Click Measurement Guidelines: Version 1.0*. (2009). Interactive Advertising Bureau. United kingdom.
- Fish, R. (2012). Physical Architecture Layer Design. [presentation]. Foster School of Business, University of Washington.
- Ghose A. and Yang S. (2007). *Comparing Performance Metrics in Organic Search with Sponsored Search Advertising*. From Summon Web-Scale Discovery e-database.
- Greengard S. (2012). *Advertising Gets Personal; Online behavioral advertising and sophisticated data aggregation have changed the face of advertising and put privacy in the crosshairs*. [News]. From ACM Digital Library e-database.
- Mccooy S., Everard A., Polak P., and Galletta D. F. (2007). *The Effects Of Online Advertising*. From ACM Digital Library e-database.
- Rogers A., David E., Payne T. R., and Jennings N. R. (n.d.). *An Advanced Bidding Agent for Advertisement Selection on Public Displays*. From Summon Web-Scale Discovery e-database.

Yuan S., Abidin A. Z., Sloan M., and Wang J. (2012). *Internet Advertising: An Interplay among Advertisers, Online Publishers, Ad Exchanges and Web Users*. University College London.

Yung M. L., and Jhih H. J. L. (2008). *Pricing display ads and contextual ads: Competition, acquisition, and investment*. Elsevier B.V. From Summon Web-Scale Discovery e-database.

APPENDICES

APPENDIX 1.0: INTERNET ADVERTISING USER INTERFACE

 InternetAdvertising

HOME

Inventory
Create Inventory

Order
Create Order

Admin
Create Order

All Inventories

New Inventory

Webpage

Ads Unit

Name:

Size:

Category:

 InternetAdvertising

HOME

Inventory
Create Inventory

Order
Create Order

Admin
Create Order

All Inventories

No	Webpage	Name	Size	Category
1	itreview_phone 5	left_side_ads	600x800px	gadget
2	personalympic 2012	top_banner	728x90px	spot
3	itreview_phone 5	side_banner	600x800px	gadget
4	personalympic 2012	top_banner	600x800px	gadget

Codes for inventory

```
<div id="ads_php" style="width: 728px; height: 90px; border: 1px solid black;"></div>
<div id="ads_php" style="width: 600px; height: 800px; border: 1px solid black;"></div>
```

InternetAdvertising

New Order

Company:

Item line

Name:

Size:

Start Time:

End Time:

Category:

Target Inventory

Category:

Geographic:



Order Upload

Upload: No file chosen

Click through URL:

InternetAdvertising

All Orders

No	Company	Size	Start	End	Category	Picture
1	it_supplier	600x800px	23/03/2013	25/05/2013	gadget	
2	phone taman maju	180x150px	15/03/2013	19/03/2013	gadget	
3	seribayu_phone	600x800px	23/03/2013	24/04/2013	gadget	
						

APPENDICES

APPENDIX 2.0: TECHNICAL PAPER