

# **Optimal Design of Wheelchair Drive Mechanism**

**by**

Mohamed Zakiran Bin Zainuddin

Dissertation submitted in partial fulfillment of

the requirements for

Bachelor of Engineering (Hons)

(Mechanical Engineering)

SEPTEMBER 2013

Universiti Teknologi PETRONAS

Bandar Seri Iskandar

31750 Tronoh

Perak Darul Ridzuan

# **CERTIFICATION OF APPROVAL**

## **Optimal Design of Wheelchair Drive Mechanism**

By

Mohamed Zakiran Bin Zainuddin

A project dissertation submitted to the

Mechanical Engineering Programme

Universiti Teknologi PETRONAS

in partial fulfilment of the requirement for the

**BACHELOR OF ENGINEERING (Hons)**

**(MECHANICAL ENGINEERING)**

Approved by,

-----

(Dr Dereje Engida Woldemichael)

**UNIVERSITI TEKNOLOGI PETRONAS**

**TRONOH, PERAK**

**December 2013**

## **CERTIFICATION OF ORIGINALITY**

This is to certify that I am responsible for the work submitted in this project, that the original work is my own except as specified in the references and acknowledgements, and that the original work contained herein have not been undertaken or done by unspecified sources or persons.

.....

MOHAMED ZAKIRAN BIN ZAINUDDIN

## **Abstract**

This research entitle optimal design of wheelchair drive mechanism is to optimize the design of wheelchair drive mechanism. The wheelchair has become more than just a mean of transportation device. It has also become a tool for the disable people to carry out their lives and doing task everyday such as doing work especially. This shows that wheelchair must be reliable and has a long lasting service life in order to serve the disabled people better. Thus, the need of making the wheelchair to be more resistant to break due to heavy load, less difficulty in moving or user-friendly and better in terms of design The drive mechanism of a self-propelled wheelchair made up of the shafts, gears, ratchet, wheel, etc. to function properly. This project focused only on several part of the drive mechanism which is the shafts and gear mechanism.

The project focused on the optimization of the shafts and gear mechanism in terms of the best design while considering the objective of the optimization process. Apart from the optimization of the design, a simulation model will be created to aid in the design of the mechanism will be created and will serve as a tool in the future for designer who want to design an optimized shaft and gear mechanism. The project undergoes optimization in term of design parameters before the simulation can be created. The simulation produces result of optimized value of diameters of shaft and design specifications of gears using selected material. The results indicated a better suggestion of design parameters that should be taken account for the designer in order to maximize the capabilities of his design and selected materials. Even though the simulation can be run and produce optimized value, it is still not perfect as the simulation is not entirely universal to any shaft or gears design. Only certain size of shaft which is under the given ranges of calculated values can be run and the simulation only for spur gears type no other types of gears such as bevel, helical and etc. Further improvement need to be conducted for the simulation to achieved higher level of design.

## **ACKNOWLEDGEMENTS**

I would like to express my highest gratitude and appreciation to all parties that have involved, whether directly or indirectly, in contributing for this final year project until its success. Throughout the whole schedule of the project, valuable knowledge and experience have been learned that will be a strong guidance for my future career.

First and foremost, I would like to thank Mechanical Engineering Department and my supervisor for assisting and guiding me in selecting my FYP title. With their strong support, I have been able to select a new gap for a research area that is related to my background of study. I would like to dedicate a special thanks to my supervisor, Dr Dereje Engida Woldemichael for his actions and supports in assisting me with ideas and knowledge for my FYP project schedules and simulation works. Without his guidance, I could not have finished the project.

Last but not least, many thanks to my family and friends, and all people that have been supporting me for all four years of experience in my degree, especially in Mechanical Engineering Department. As for the support and encouragement from these people, I am able to perform my study and project to the best of my ability. Thank you and may you be rewarded for all your kindness.

# TABLE OF CONTENTS

<b>CERTIFICATION OF APPROVAL</b> .....	i	
<b>CERTIFICATION OF ORIGINALITY</b> .....	ii	
<b>ABSTRACT</b> .....	iii	
<b>ACKNOWLEDGEMENTS</b> .....	iv	
<b>TABLE OF CONTENTS</b> .....	v	
<b>LIST OF FIGURES</b> .....	vi	
<b>LIST OF TABLES</b> .....	vii	
<b>CHAPTER 1: PROJECT BACKGROUND</b>		
1.1 Background of study.....	1	
1.2 Problem Statement.....	3	
1.3 Objectives.....	4	
1.4 Scope.....	5	
1.5 Outline.....		
<b>CHAPTER 2: LITERATURE REVIEW</b>		
2.2 Shafts literature review.....	6	
2.3 Gears literature review.....	8	
<b>CHAPTER 3: METHODOLOGY</b>		
3.1 Research methodology.....	10	
3.2 Flow chart.....	11	
3.3 Gantt-chart.....	12	
3.4 Modeling.....	13	
3.5 Tool.....	29	
<b>CHAPTER 4: RESULTS AND DISCUSSION</b>		
4.1 Results and Discussion.....	30	
4.2 Case study.....	34	
<b>CHAPTER 5: CONCLUSION</b> .....		36
<b>REFERENCES</b> .....	37	

## LIST OF FIGURES

Figure 1.1: Types of wheelchair.....	2
Figure 3.1: Project activities flow diagram.....	10
Figure 3.2: Project flow chart.....	11
Figure 3.4.1.1: CAD drawing of Gear and Shaft mechanism.....	13
Figure 3.4.1.1: Shaft diagram.....	13
Figure 3.4.1.1: Shaft diagram with forces .....	14
Figure 3.4.1.1: Shaft diagram.....	15
Figure 3.4.1.5: Torque Graph.....	15
Figure 3.4.1.6: Moment Graph.....	16
Figure 3.4.1.7: Shaft diagram.....	20
Figure 3.4.2.1: Pinion and Gear.....	23
Figure 3.4.2.2: AGMS 218.01.....	25
Figure 3.5.1: Shaft Excel Simulator.....	29
Figure 3.5.2 Gear Excel Simulator.....	29
Figure 4.1.1 CAD drawing of wheelchair.....	30
Figure 4.1.2: Material VS Diameter of Shaft.....	31
Figure 4.1.3: Material VS Volume of Shaft .....	32
Figure 4.1.4: AISI 1006 CD.....	32
Figure 4.1.5: AISI 1015 .....	32
Figure 4.1.6: AISI 1081 CD.....	32
Figure 4.1.7: AISI 1060 Annealed .....	32
Figure 4.1.8: Material VS Volume of Gear .....	33
Figure 4.1.9: Material VS Diameter of Gear.....	33

## LIST OF TABLES

Table 3.1: Gantt chart.....	13
Table 3.4.2: Gear and pinion Material Properties.....	30
Table 4.1.1: Shaft simulation material properties.....	31
Table 4.1.2: Gear simulation material properties.....	34
Table 4.2.2: Case Study 1 Values .....	35
Table 4.2.2: Case Study 2 Values .....	36
Table 4.2.3: Case Study 3 Values .....	36



# CHAPTER 1: PROJECT BACKGROUND

## 1.1 Background of study

Disability is part of the human condition. Almost everyone will experience a temporary or permanently period of impaired at some point in life, and those who survive to old age will experience increasing difficulties in functioning. Most extended families have a disabled member and many non-disabled people take responsibility to support and care for their relatives and friends with disabilities. The number of patients with disabilities has risen in the recent years. In the official report produced by the World Health Organization (WHO) and World Bank, “The Global Disabled Persons Report” in 2011 stated that there are 650 million people which are 10% of the global population are disabled in the 1970s and now has increased to 15%. By adding the aging population who suffer from chronic disease which is increasing will make the proportion of disable persons expand (Zhang L. et al., 2012).

People with physical disability have less quality of life and are not fully independent by themselves. They rely on other people to help them in situation that is impossible for them to carry out due to their disability. Task such as climbing stairs , reaching out for thing in higher places , getting into a vehicle and others , that make a big impact between being normal or being physically disable . This kind of step backs in life that makes those who suffer physical disability unable to life their lives to the fullest and felt incomplete. Being disable does not only affect yourself, but it affect those who are around you also .It becomes a burden to their family. Any family of the physical disables will not hesitate to help their flesh and blood, but in the end of the day, taking care of people with physical disability is not an easy task to do.

Thanks to an unknown inventor in 1595, a chair with wheels was invented for Philip II of Spain. The chair was made due to his physical disability and was first known as invalid’s chair. Now it is known as a wheelchair. A Wheelchair acts as a means of transport tool and plays an important role in the life of those who are not only disabled

but old also. There are many type of wheelchair that is available to help those people in their daily activities and requirement.



**Figure 1.1 Types of wheelchair**

A normal wheelchair can be divided in to three categories, manual or self-propelled wheelchairs, wheelbase and attendant-propelled chairs (Manual Wheelchairs - Types and Reviews , 2013) . A self-propelled wheelchair is a wheelchair that is propelled by the occupant itself whereas attendant-propelled wheelchairs are propelled by a caregiver or friend who will push the wheelchair using the handles. A wheelbase chairs is more custom wheelchair that suits the users posture and this type of wheelchair usually used by users that has complicated posture problem (Manual Wheelchairs - Types and Reviews , 2013) .

For the drive mechanism, a typical wheelchair drive mechanism consists of level arms, ratchet, shafts and gears. These components ensure the transitions of motion from the level arm to the wheel. When the level arm is pushed forward, it creates a motion in the ratchet to move and rotates the shafts connected. This will then causes the gears connected to the shafts to rotate as well as gears connected to the wheel. Thus, causing the wheels to move. A simple transition of motion that occur in the drive mechanism of wheelchair that causes the wheelchair to move but require a lot of effort from the occupant. Moreover, the design parameters those are used to make the components have limited constraints and tend to fatigue if operated beyond capability of the design.

Thus , a manual type of wheelchairs are chosen for this project as it is widely used by the public due to its affordable price and there are rooms for improvement in terms of the drive mechanism design. Most of all , the project will serve a better purpose in benefiting the mass of disable people in the public .

## **1.2 Problem statement**

Wheelchair is well known forms of transportation that increase the mobility of the physically impaired or disable people. They require wheelchair greatly in assisting them to move around and not being too dependent on other people. Wheelchair help them to move from one place to another by their own .In other words, wheelchair helps them in their everyday lives. But to recent years, the wheelchair has become more than just a mean of transportation device. It has also become a tool for the disable people to carry out their lives and doing task everyday such as doing work especially. This shows that wheelchair must be reliable and has a long lasting service life in order to serve the disabled people better. Thus, the need of making the wheelchair to be more resistant to break due to heavy load, less difficulty in moving or user-friendly and better in terms of design has come to attention. In this project, an optimized design of wheelchair in term of the shafts and gears system is to be produced that is cost effective, good material usage and require less force to be moved.

### **1.3 Objective**

The objective of this project is to develop optimal design parameters for the design of wheelchair drive mechanism used by disabled people. The wheelchair drive mechanism can be categorized into the level handle, the gear and shaft and the wheel system which can be optimized individually. In this project, the optimization of gear and shaft mechanism will be addressed. The objectives of the design project include the following.

- To identify and select best specifications of shaft mechanism through optimization.
- To identify and select best specifications of gear mechanism through optimization.
- To select suitable material while considering manufacturing factors
- To develop a simulation to aid in selection of criteria and specifications of the shaft and gear mechanism design

### **1.4 Scope of Project**

There are several scopes of work involved in this project. One of it is to design the gears and shafts mechanism in terms of the material selection. The material selection process will be done based on the material characteristics, cost and manufacturing constraints. Besides that, minimising the force required to operate the wheelchair is also one of the scope of works. It is to ensure that the occupant will not have to exert a lot of energy in order to move the wheelchair and this can also lessen the burden of work to move the wheelchair. Moreover, the project also aims to produce an optimized design of the gears and shafts mechanism. The optimized gears and shafts system will have higher efficiency in transmission and cost-effective. A simulation model of the gears and shafts mechanism that are applicable to other application in terms of drive mechanisms will be created to aid in the optimization of design.

## **1.5 Outline**

Chapter 1 : Basic introduction about the project and the objective of undertaking.

Chapter 2 : Literature review is the papers written previously that contain information and knowledge regarding the project .

Chapter 3 : The methods used along the completion of the project to obtain the results.

Chapter 4: Result obtained for the project.

Chapter 5 : Conclusion derived from the project .

# CHAPTER 2: LITERATURE REVIEW

## Literature review

### 2.1. Shafts

Shafts are a mechanical component for transmitting torque and rotation. It is used to connect other components of a drive train that cannot be connected directly due to distance or cannot be together. They act as medium to carry torques thus subjecting them to torsion and shear stress. They must therefore be strong enough to bear the stress, whilst avoiding too much additional weight as that would in turn increase their inertia and break if beyond their capability. (Wikipedia Drive Shaft, 2013) Many conventional methods have been widely used mainly in mechanical design problems. They are deterministic in nature and use only a few geometric design variables due to their complexity and convergence problems. (Mendia F. et al., 2010) .The main disadvantages of them are slow convergence along with local minima (or maxima) problems. When the number of design parameters increase, the complexity increases drastically. Many practical optimum design problems are characterized by mixed continuous-discrete variables, and discontinuous and non-convex design spaces. If the optimization problem involves the objective function and constraints that are not stated as explicit functions of the design variables or which are too complicated to manipulate, it is hard to solve by classical optimization methods. Therefore, some optimization methods such as genetic algorithm (GA) (Ra B. R. et al., 2007) and Evolutionary Structural Optimization (ESO) on Rotating Shafts in (Tanb A. et al., 2007) have been developed to solve complex optimization problems recently.

GA, which is one of the stochastic methods of optimization, has been commonly used for the optimal design machine systems. (Mendia F. et al., 2010) stated that the main advantages of genetic algorithms (GAs) are an assured convergence without use of derivatives and functions with discrete and non-derivable variables and it has also been

applied to many areas including machine design. Evolutionary structural optimization (ESO) method, which is introduced by Xie and Steven (Tanb A. et al., 2007) in 1993, is based on the simple idea that the optimal structure (maximum stiffness, minimum weight) can be produced by gradually removing the ineffectively used material from the design domain. The ESO is very simple to program via the finite element analysis (FEA) package and requires a relatively small amount of FEA time. Additionally, the ESO topologies have been compared with analytical ones, and so far the results are quite promising. On the other hand, ESO does not have a solid theoretical basis, and consequently, the ESO minimization problem is still unsolved. ESO main reason is to provide engineering industry with a practical and user-friendly optimization method to assist in the design process. Hence, ESO has been extended to accommodate various optimization criteria and is becoming a more practical method (Tanb A. et al., 2007). Moreover, in recent paper on the robust design optimization on vibrating rotor –shaft system (Stocki R. et al. 2011) highlighted the use of Latin hypercubes in scatter analysis of the vibration response on a single-span rotor shaft of the 8-stage centrifugal compressor that addresses the uncertainties of residual unbalances. The optimal rotor-shaft shape design significantly reduces the risk of rubbing during operation when rotor-shaft system passes through the resonance excitation during start-ups as well as run-downs of the compressor.

## 2.2 Gears

Gears are a rotating part that meshes together with another gear in order to transmit torque. Every gear has cut teeth or cogs and it is the part that toothed with other toothed part from other gear. Two or more gears working together are called a transmission and can produce a mechanical advantage through a gear ratio and thus may be considered a simple machine. Geared devices can change the speed, torque, and direction of a power source. The most common situation is for a gear to mesh with another gear. However, a gear can also mesh with a non-rotating toothed part, called a rack, thereby producing translation instead of rotation. The gears in a transmission are analogous to the wheels in a pulley. An advantage of gears is that the teeth of a gear prevent slipping. When two gears of unequal number of teeth are combined, a mechanical advantage is produced, with both the rotational speeds and the torques of the two gears differing in a simple relationship (Wikipedia Gear, 2013).

In this field of transmission, one of the most important objectives is to realize gears with high efficiency so as to reduce power losses, operating temperatures, noise and wear (Baglioni S. et al., 2012). The spur gear efficiency was studied using two different approaches for friction coefficient calculation along the line of action in order to evaluate the possible differences. There were also studies that were mainly focused on good tooth capacity and efficiency in order to design long lasting and power loss gears (Baglioni S. et al., 2012). The papers proposed in order to improve gear efficiency, load dependent losses are focused and several different formulations of the friction coefficient between the teeth are proposed. Friction can be considered as the resistance to motion between two surfaces in relative sliding and rolling under dry or lubricated contact conditions; thus the lubricant applied to gearing, with the package of additives, significantly alters contact conditions and hence friction. If friction between teeth has to be reduced, sliding velocity, load and friction coefficient acting along the contact path are the determinant parameters to be taken into deep consideration (Baglioni S. et al., 2012). Surfaces of contacting gear teeth are subject to combined rolling and sliding actions as gears rotate. The resultant rolling and sliding components of friction forces apply along the off-line-of-action (OLOA) direction (normal to the line-of-action (LOA))



direction that is tangent to the base circles of gears) to form the main excitations for motions along the OLOA direction, at the same time producing friction moments acting in the torsional direction to couple OLOA and LOA motions (Li S. et al., 2013). Referring to Hai Xu (Xu, 2005) that it is also possible to modify the tooth form and the place of the contact line on the addendum modification  $X_i$  can also influences the efficiency of the gear as well as reducing fiction between by modify the center distance . Moreover, using asymmetric gear design can also improve the bending stress in spur gears (Pedersen, 2010). Pederson work shows that the bending stress is indirectly related to shapes of the cutting tool. His works shows that the bending stress can be reduced significantly by using asymmetric gear teeth and by shape optimizing the gear through changes made to the tool geometry. However, in order to obtain the largest possible stress minimization, a custom tool must be designed depending on the number of teeth. Small design changes will not affect the stress minimization. Design changes of the gears are achieved indirectly by redesigning the cutting tool. Cutting tool parameterization includes the possibility of an asymmetric tooth; it is simple as it only requires four design parameters. Resulting optimized designs show that a significant reduction in the bending stress is possible. Furthermore, the cutting tool shape is described analytically and hence so is the cut teeth shape (Pedersen, 2010).Construction of S-shaped transition curve and extended 2D and 3D spur gear tooth design using Cubic Trigonometric (Abbas M. et al., 2012) able to make the spur gear more flexible due to low degree and the presence of shape parameters. The research also serve as tool for designer and manufacturers in designing of gears using the Cubic Trigonometric function as one of the acceptable application in designing spur gear.

## CHAPTER 3: METHODOLOGY / PROJECT WORK

### 3.1 Research Methodology

The project activities flow sequences above shows the general procedure of optimization of wheelchair drive mechanism. The flow of steps in conducting the project will be started with the data gathering of wheelchair's gears and shafts design .Based from the information gathered , parameters such as length of parts , diameter of circular parts ,number of gears tooth and etc. from the will be selected as variables. After that, certain criteria will be set to be optimized as well as the constrains in the optimized design.

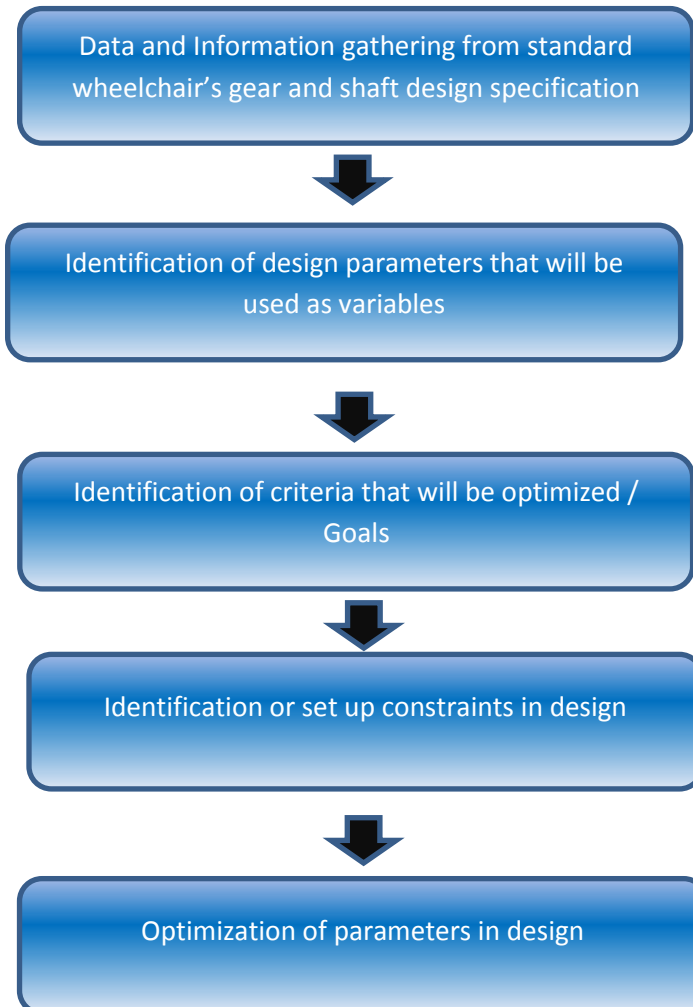

Figure 3.1 Project activities flow sequences

### **3.2 Flow Chart**

The project was divided into 2 parts, which is the shaft mechanism and the gear mechanism. By referring to Figure 3, each of the mechanism will go through similar process which is the optimization. The optimization process include in the identifying variables, setting up parameters, setting up objective function and putting up constraints in the optimization. After that , a mathematical model was to be constructed for the shaft and the gear. This is to design the shaft and gears theoretically using formula calculation. By using the mathematical modeling , a simulation program can be create using Microsoft Excel Solver .The Solver can do calculation and follow the optimization criteria .When the simulation is done , the user will need to input certain values of the design such as material properties , design variables and constraints of his design . Run the simulation to obtain results. The results will then be analyze , if results obtained is not favorable , other values of the input must be inserted until the expected results obtained . When the simulation is done, the process of documentation will begin to end the project.

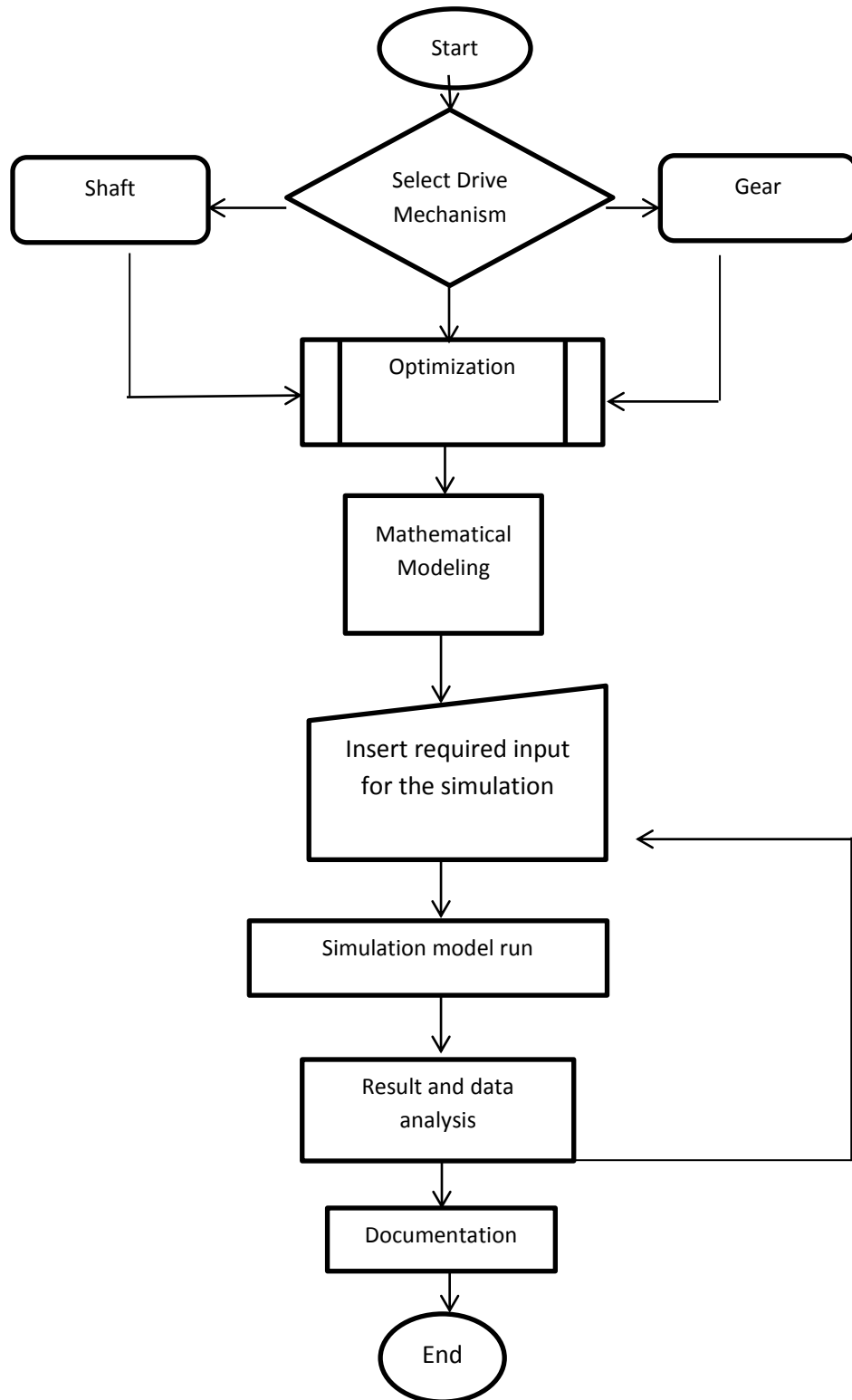



Figure 2.2 Project flow chart

### 3.3 Gantt Chart

No	Activities	Week																											
		1	2	3	4	5	6	7	8	9	10	11	12	13	14	15	16	17	18	19	20	21	22	23	24	25	26	27	28
1	Introduction to project background regarding Optimizing concepts	█	█	█																									
2	Collecting journals as references for project				█																								
3	Data and information gathering					█	█	█	█	█	█																		
4	Identification of variables of the shaft mechanism and gear mechanism										█	█																	
5	Shafts mechanism project focus /Mathematical modeling											█	█	█	█	█	█	█	█										
6	Gears mechanism project focus / Mathematical modeling																	█	█	█	█	█	█						
7	Start on simulation software																							█	█				
8	Material properties testing via simulation																							█	█	█	█		
9	Result and data analysis																										█	█	█
10	Documentation																												█

 Completed Task  
 Planned Task

### 3.4 Modeling

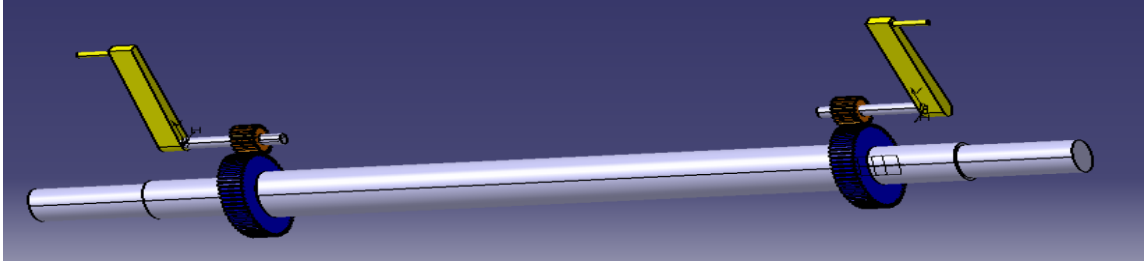

Figure 3.4.1.1 CAD drawing of Gear and Shaft Mechanism

#### 3.4.1 Shaft

A case study of mathematical model was done for shaft. One of the variables was selected which is the diameter of the shafts, in order to achieve optimization of the volume of shaft used in the design. Below is the calculation based on one of the material selected, Gray Cast Iron ASTM No 20 (Keith J. et al., 2008). The stress analysis was also done using the De –Gerber, De-Goodman, De-ASME Elliptic and De-Sodenberg. A few parameters were also set constant in the calculation.

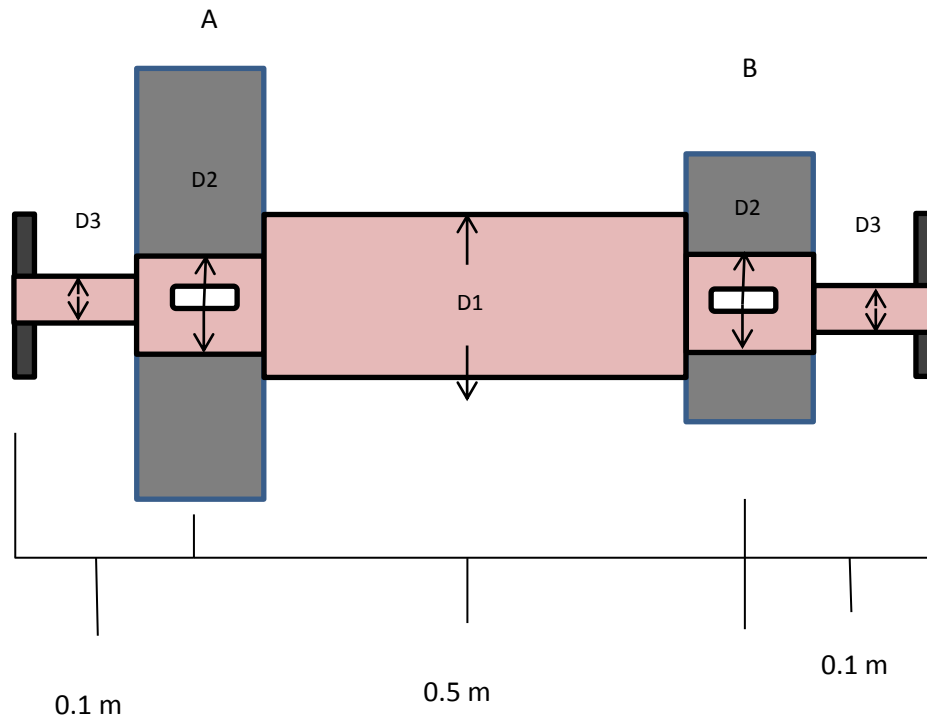

Figure 3.4.1.2 Shaft diagram

**At Gear A**

$$T_1 = 100 \text{ N.m} \quad T_A = 100 \times 3 = 300 \text{ N.m}$$

$\therefore$  pressure angle =  $\alpha = 20^\circ$

$$F_{A_t} = \frac{T_2}{D/2} = \frac{300}{\frac{0.1}{2}} = 6000 \text{ N} \quad F_{A_r} = F_{A_t} \cos 20^\circ = 2184 \text{ N}$$

**At Gear B**

$$T_A = T_B = 300 \text{ N.m} = F_{B_t} r$$

$$F_{B_t} = \frac{T_B}{r} = 12000 \text{ N} \quad F_{B_r} = F_{B_t} \tan 20^\circ = 4368 \text{ N}$$

A free body diagram analysis was performed to get the reaction forces at the bearings.

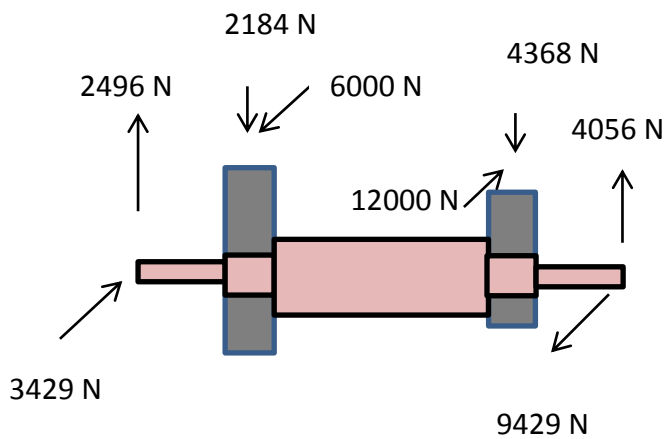

Figure 3.4.1.3 Shaft diagram with force

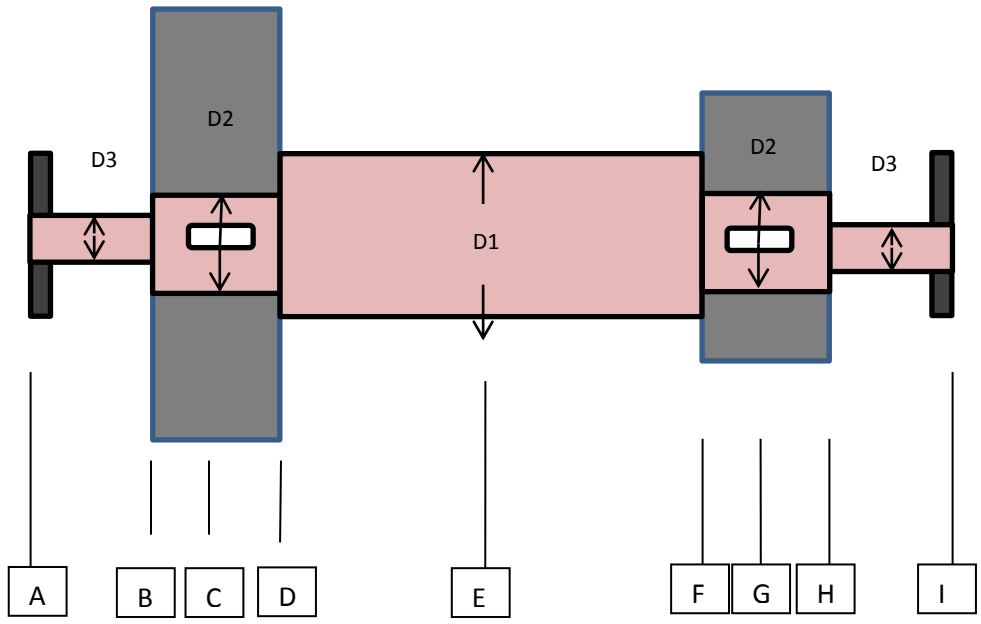

Figure 3.4.1.4 Shaft diagram

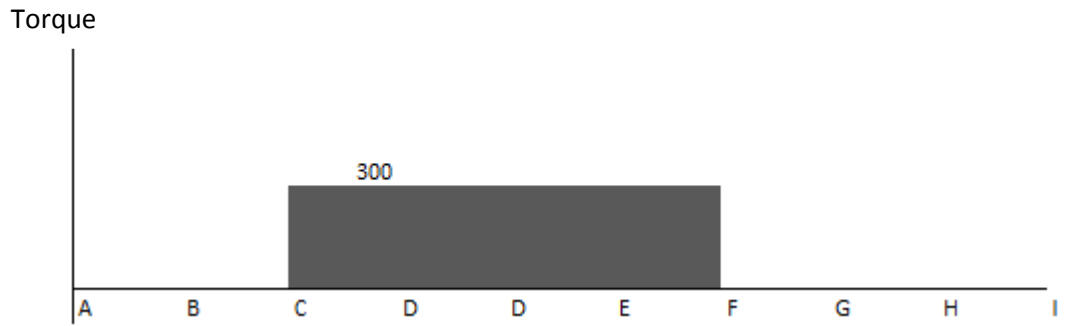

Figure 3.4.1.3 Torque graph



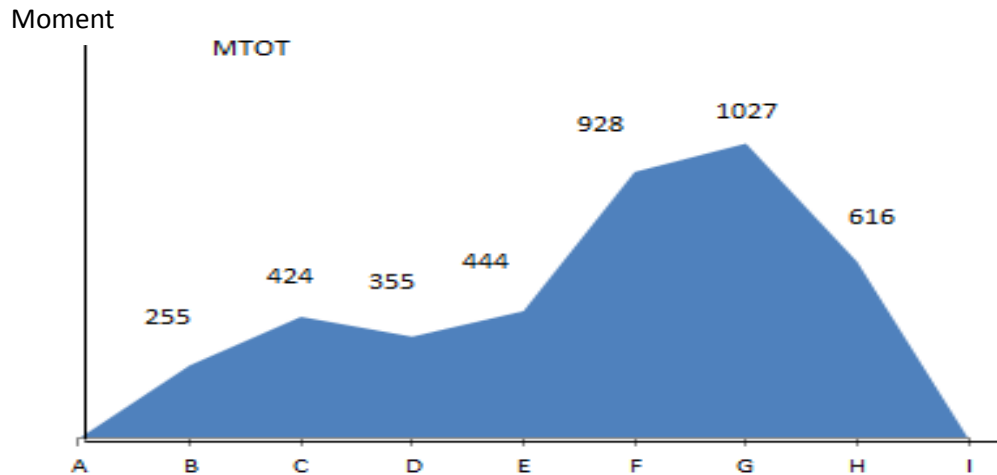

Figure 3.4.1.4 Moment graph

A material was chosen for calculation. Gray Cast Iron ASTM No 20 with the characteristics :

$$S_{ut} = 152 \text{ MPa} \quad S_e = 69 \text{ MPa}$$

$\therefore$  with safety factor  $n_d = 1.5$

#### At point F in Figure 3.4.1.4

For first estimate of the small diameter at the shoulder at point I , DE-Goodman criterion of Eq (7-8 ) from *Shigley's Mechanical Engineering Design*, 8<sup>th</sup> was selected. This criterion is good for the initial design , since it is simple and conservative.  $M_a = 927 \text{ N.m}$  ;  $T_m = 300 \text{ N.m}$  ;  $M_m = T_a = 0$  .

Equation 7-8(*Shigley's Mechanical Engineering Design*, 8<sup>th</sup> )

$$d = \left\{ \frac{16n}{\pi} \left( \frac{2(K_f M_a)}{S_e} + \frac{[3(K_{fs} T_m)^2]^{1/2}}{S_e} \right) \right\} \quad \text{eq 3.4.1.1}$$

$$d = 0.073 \text{ m} = 73 \text{ mm}$$

A typical D/d ratio for support at shoulder  $\frac{D}{d} = 1.2$ .

Change 'd' to 0.07 m.

$$D = d(1.2)$$

$$D = 0.084m \sim 0.085m$$

$$\text{Assume fillet radius } r = \frac{d}{10} = \frac{0.07}{10} = 0.007 \text{ m} \cdot r/d=0.1$$

$$K_t = 1.6 \quad , q=0.2$$

$$K_f = 1 + q(K_t - 1) = 1.12$$

$$K_{ts} = 1.35 \quad , q=0.8$$

$$K_{fs} = 1 + q(K_{ts} - 1) = 1.4$$

Equation 7-7(Shigley's Mechanical Engineering Design, 8<sup>th</sup> )

$$\frac{1}{n} = \frac{16}{\pi(d)^3} \left\{ \left[ \frac{1}{S_e} \left[ 4(K_f M_a)^2 + 3(K_{fs} T_a)^2 \right] \right]^{\frac{1}{2}} + \left[ \frac{1}{S_{ut}} \left[ 4(K_f M_m)^2 + 3(K_{fs} T_m)^2 \right] \right]^{\frac{1}{2}} \right\} \text{ eq 3.4.1.2}$$

$$\therefore n = 1.58$$

**At point H in Figure 3.4.1.4**

$$\frac{D}{d} = 1.2$$

$$d = \frac{0.07}{1.2} = 0.06 \text{ m} \cdot r/d=0.1$$

$$K_t = 1.6, q=0.2$$

$$K_f = 1 + q(K_t - 1) = 1.12$$

$$K_{ts} = 1.35 \quad , q=0.8$$

$$K_{fs} = 1 + q(K_{ts} - 1) = 1.4$$

$$\therefore S_e = 69 \text{ MPa} ; M_a = 616 \text{ N.m} ; M_m = T_a = T_m = 0$$

$$\frac{1}{n} = \frac{16}{\pi(d)^3} \left\{ \left[ \frac{1}{S_e} \left[ 4(K_f M_a)^2 + 3(K_{fs} T_a)^2 \right] \right]^{\frac{1}{2}} + \left[ \frac{1}{S_{ut}} \left[ 4(K_f M_m)^2 + 3(K_{fs} T_m)^2 \right] \right]^{\frac{1}{2}} \right\} \text{ eq 3.4.1.3}$$

$$n = 2.12$$

#### At point G in Figure 3.4.1.4

Diameter at the end of the keyway also checked even though keyway in this study is not considered. From the moment diagram,  $M$  at the end of the keyway to be  $M_a = 1027 \text{ N.m}$ ;  $T_m = 300 \text{ N.m}$

$$K_f = 1.7 ; K_{fs} = 1.5$$

$$\frac{1}{n} = \frac{16}{\pi(d)^3} \left\{ \left[ \frac{1}{S_e} \left[ 4(K_f M_a)^2 + 3(K_{fs} T_a)^2 \right] \right]^{\frac{1}{2}} + \left[ \frac{1}{S_{ut}} \left[ 4(K_f M_m)^2 + 3(K_{fs} T_m)^2 \right] \right]^{\frac{1}{2}} \right\} \text{ eq 3.4.1.4}$$

$$n = 1.2$$

The keyway turns out to be more critical than the shoulder. Thus a higher strength material are used. Material ASTM G10060 CD.

$$S_{ut} = 330 \text{ MPa} \quad S_e = 280 \text{ MPa}$$

$$k_a = 0.97 ; k_b = 2.3 ; k_c = k_d = k_e = 1$$

$$\therefore S_e = 368 \text{ MPa}$$

$$K_t = 1.7, q=0.6$$

$$K_f = 1 + q(K_t - 1) = 1.42$$

$$K_{ts} = 1.5, q=1$$

$$K_{fs} = 1 + q(K_{ts} - 1) = 1.5$$

$$\therefore M_a = 927 \text{ N.m} ; T_m = 300 \text{ N.m} ; M_m = T_a = 0$$

$$\frac{1}{n} = \frac{16}{\pi(d)^3} \left\{ \left[ \frac{1}{S_e} \left[ 4(K_f M_a)^2 + 3(K_{fs} T_a)^2 \right] \right]^{\frac{1}{2}} + \left[ \frac{1}{S_{ut}} \left[ 4(K_f M_m)^2 + 3(K_{fs} T_m)^2 \right] \right]^{\frac{1}{2}} \right\} \text{ eq 3.4.1.5}$$

$$n = 7.07$$

Since  $n$  is greater than 1.5, it is accepted.

**At point I in Figure 3.4.1.4**

$$M_a = 206 \text{ N.m} ; T_m = M_m = T_a = 0$$

$$r/d=0.02 \text{ m}$$

$$K_t = 2.7 \text{ \textbackslash\ , } q=0.65$$

$$K_f = 1 + q(K_t - 1) = 2.105$$

$$K_{ts} = 2.2 \text{ , } q=0.9$$

$$K_{fs} = 1 + q(K_{ts} - 1) = 2.08$$

$$\therefore M_a = 927 \text{ N.m} ; T_m = 300 \text{ N.m} ; M_m = T_a = 0$$

$$\therefore S_e = 368 \text{ MPa} ; S_{ut} = 152 \text{ MPa}$$

$$\frac{1}{n} = \frac{16}{\pi(d)^3} \left\{ \left[ \frac{1}{S_e} \left[ 4(K_f M_a)^2 + 3(K_{fs} T_a)^2 \right] \right]^{\frac{1}{2}} + \left[ \frac{1}{S_{ut}} \left[ 4(K_f M_m)^2 + 3(K_{fs} T_m)^2 \right] \right]^{\frac{1}{2}} \right\} \text{ eq 3.4.1.6}$$

$$n = 3.37$$

With the diameters specified checked , the diameters of the point can be concluded as:

$$D_1 = 0.085 \text{ m}$$

$$D_2 = 0.07 \text{ m}$$

$$D_3 = 0.06 \text{ m}$$

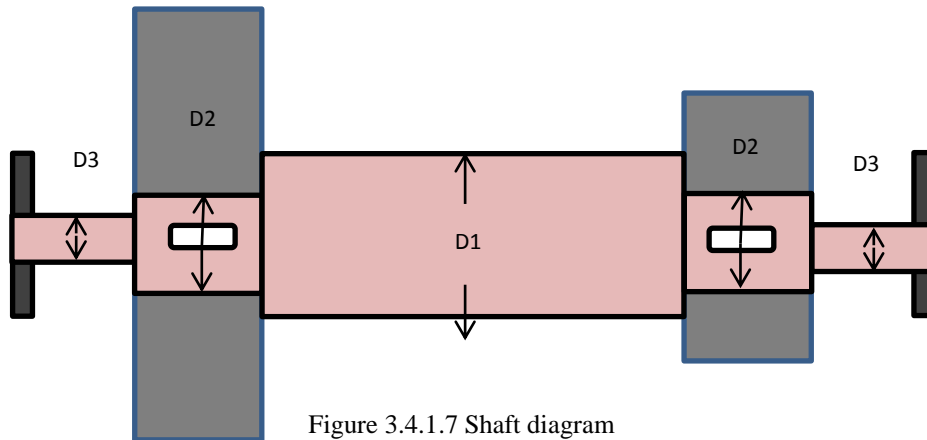

Figure 3.4.1.7 Shaft diagram

### Stress analysis of shaft diameter:

#### De-Goodman

Equation 7-8(Shigley's Mechanical Engineering Design, 8<sup>th</sup> )

$$d = \left( \frac{16n}{\pi} \left\{ \frac{1}{S_e} \left[ 4(K_f M_a)^2 + 3(K_{fs} T_a)^2 \right]^{\frac{1}{2}} + \frac{1}{S_{ut}} \left[ 4(K_f M_m)^2 + 3(K_{fs} T_m)^2 \right]^{\frac{1}{2}} \right\} \right)^{\frac{1}{3}} \text{ eq 3.4.1.7}$$

$$D_1 = 0.085 \text{ m}$$

$$D_2 = 0.07 \text{ m}$$

$$D_3 = 0.06 \text{ m}$$

#### De-Gerber

Equation 7-10(Shigley's Mechanical Engineering Design, 8<sup>th</sup> )

$$d = \left( \frac{8nA}{\pi S_e} \left\{ 1 + \left[ 1 + \left( \frac{2BS_e}{AS_{ut}} \right)^2 \right]^{\frac{1}{2}} \right\} \right)^{\frac{1}{3}} \text{ eq 3.4.1.8}$$

Where

$$A = \sqrt{4(K_f M_a)^2 + 3(K_{fs} T_a)^2}$$

$$B = \sqrt{4(K_f M_m)^2 + 3(K_{fs} T_m)^2}$$

$$D_1 = 0.075 \text{ m}$$

$$D_2 = 0.062 \text{ m}$$

$$D_3 = 0.052 \text{ m}$$

### De-ASME Elliptic

Equation 7-12(Shigley's Mechanical Engineering Design, 8<sup>th</sup> )

$$d = \left( \frac{16n}{\pi} \sqrt{\frac{A^2}{S_e^2} + \frac{B^2}{S_y^2}} \right)^{\frac{1}{3}} \text{ eq 3.4.1.9}$$

Where

$$A = \sqrt{4(K_f M_a)^2 + 3(K_{fs} T_a)^2}$$

$$B = \sqrt{4(K_f M_m)^2 + 3(K_{fs} T_m)^2}$$

$$D_1 = 0.075 \text{ m}$$

$$D_2 = 0.062 \text{ m}$$

$$D_3 = 0.052 \text{ m}$$

### De-Soderberg

Equation 7-13(Shigley's Mechanical Engineering Design, 8<sup>th</sup> )

$$d = \left[ \frac{16n}{\pi} \left( \frac{A}{S_e} + \frac{B}{S_{ut}} \right) \right]^{\frac{1}{3}} \text{ eq 3.4.1.10}$$

Where

$$A = \sqrt{4(K_f M_a)^2 + 3(K_{fs} T_a)^2}$$

$$B = \sqrt{4(K_f M_m)^2 + 3(K_{fs} T_m)^2}$$

$$D_1 = 0.078 \text{ m}$$

$$D_2 = 0.065 \text{ m}$$

$$D_3 = 0.054 \text{ m}$$

### 3.4.2 Gears Calculation

A case study of mathematical model was done for gear and pinion of the gear mechanism. The module 2.5 was selected for the gear train for the design to determine the pitch diameter of pinion and gear. Different material for used for the pinion and gear to differentiate their Brinell Hardness to make the pinion teeth more harder than the gear teeth due to different stress acted on the teeth.

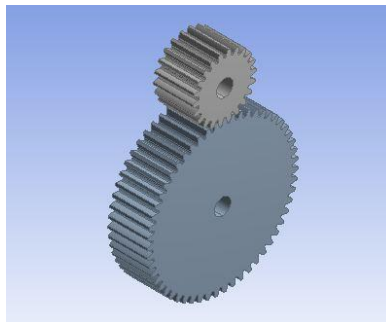

Figure 3.4.2.1 Pinion and Gear

Calculation and formulas are referred from Shigleys Mechanical engineering Design 8<sup>th</sup>.

Module ,  $m = 2.5$  ; Face Width ,  $b = 20\text{mm}$

$$N_g = 60T ; N_p = 20T$$

Pitch diameter ,  $d = mN$

$$d_g = m(N) = 150 \text{ mm}$$

$$d_p = m(N) = 50 \text{ mm}$$

Based from the shaft calculation, same transmitted load is used in the gear calculation.

$$W^t = 6000 \text{ N}$$



Diametral pitch is calculated;

$$P_g = \frac{N_g}{d} ; P_p = \frac{N_p}{d} \text{ (Equation 13-1)}$$

$$P_g = P_p = 0.4$$

Values of the Lewis Form Factor  $Y$  are obtained from Table 14-2 according to the number of gear and pinion teeth ;

$$Y_{N_g} = 0.322 ; Y_{N_p} = 0.422$$

For gear speed ;

$$n_g = 214 \text{ rpm} \quad n_p = 642 \text{ rpm}$$

$$n_g = n_p = 1.68 \text{ m/s}$$

Assuming uniform loading  $K_o = 1$  and  $K_s = 1$  as unity as suggested by AGMA. Since the project is designing gears for mass manufactured wheelchair , the gears probably will be produced by hobbing or shaping . The process is favored in industry as it is relatively inexpensive and quick.

$$V = \frac{\pi dn}{12} = 0.066 ; \text{ calculated only for gear}$$

$$K_v = \frac{3.56 + \sqrt{V}}{3.56} = 1.07$$

Based from the group AGMA 218.01 in Figure 14-6 (*Shigley's Mechanical Engineering Design, 8<sup>th</sup>* )

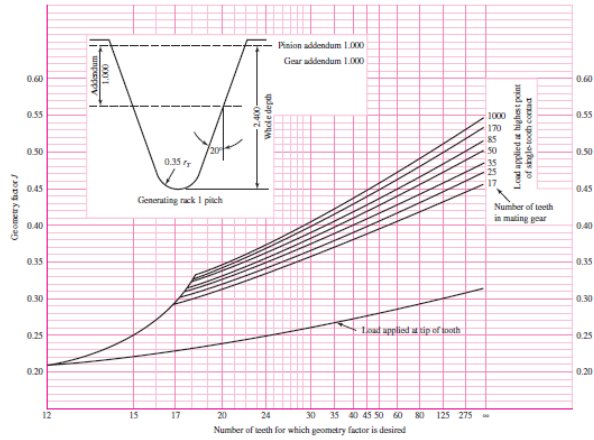

Figure 3.4.2.2 AGMS 218.01 (*Shigley's Mechanical Engineering Design, 8<sup>th</sup>* )

$$Y_{Jg} = 0.41 \quad ; \quad Y_{Jp} = 0.335$$

The load distribution factor  $K_H$  is determined, where five terms are needed. Where  $F = 20 \text{ mm}$  in when needed:

$$\text{Uncrowned; } C_{mc} = 1$$

Equation 14-32 (*Shigley's Mechanical Engineering Design, 8<sup>th</sup>*)

$$C_{pfg} = \frac{F}{10d} - 0.025$$

$$C_{pfp} = \frac{F}{10d} - 0.025$$

$$C_{pfg} = \frac{F}{10d} - 0.025 = 0.015$$

$$C_{pfp} = \frac{F}{10d} - 0.025 = -0.012$$

$$K_H = C_{mf} = 1 + C_{ma}(C_{pf}C_{pm} + C_{ma}C_e)$$

$$K_{Hg} = 1.165$$

$$K_{Hp} = 1.138$$

Assuming constant thickness gear, the rim thickness factor  $K_B = 1$ . The speed ratio is  $m_G = \frac{N_g}{N_p} = 3$ . The load cycle factor is  $10^8$  for pinion while gear is  $\frac{10^8}{3}$  cycle.

$$Y_{N_p} = 1.3588 (10^8)^{-0.0178} = 0.977$$

$$Y_{N_g} = 1.3588 \left(\frac{10^8}{3}\right)^{-0.0178} = 0.996$$

For, reliability of 0.9,  $K_R = 0.85$ . While from Figure 14-18,  $K_T = 1$  as the gear –blank temperature will not exceed  $120^\circ\text{C}$ .

Material of both gears as below :

Table 3.4.2.1 Gear and Pinion Material Properties

Material		
	Gear	Pinion
Name	610600 HR	G10950 HR
$S_{ut}$	680 MPa	830 MPa
$S_y$	370 MPa	460 MPa
$H_B$	201	248

$$S_{t_g} = 195 \text{ MPa}$$

$$S_{t_p} = 220 \text{ MPa}$$

$$I = \frac{\cos \phi \sin \phi}{2} \frac{m_G}{m_G + 1} = 0.121$$

From Table 14-8 (*Shigley's Mechanical Engineering Design, 8<sup>th</sup>*),  $Z_e = 191 \text{ MPa}$

$$\frac{H_{Bp}}{H_{Bg}} = \frac{248}{201} = 1.23$$

According to Figure 14-12, since  $1.23 > 1.2$ ,  $C_H = 1.01$

Similar from Table 14-6 (*Shigley's Mechanical Engineering Design, 8<sup>th</sup>*),

$$S_{c_g} = 322(201) + 29100 = 93822 \text{ psi}$$

$$S_{c_g} = 647 \text{ MPa}$$

$$S_{c_p} = 322(248) + 29100 = 108956 \text{ psi}$$

$$S_{c_p} = 751 \text{ MPa}$$

From Figure 14-15 (*Shigley's Mechanical Engineering Design, 8<sup>th</sup>*)

$$Z_{N_g} = 1.4488 \left( \frac{10^8}{3} \right)^{-0.023} = 0.97$$

$$Z_{N_p} = 1.4488 (10^8)^{-0.023} = 0.95$$

#### Pinion tooth bending

$$\sigma_p = W^t K_o K_v K_s \frac{1}{b m_t} \frac{K_H K_B}{Y_J} = 417483 \text{ Pa}$$

$$S_{F_p} = \frac{\left( \frac{S_T Y_N}{Y_0 Y_Z} \right)}{\sigma_{all}} = 605.7$$

#### Gear tooth bending

$$\sigma_g = W^t K_o K_v K_s \frac{1}{b m_t} \frac{K_H K_B}{Y_J} = 373965 \text{ Pa}$$

$$S_{F_g} = \frac{\left( \frac{S_T Y_N}{Y_0 Y_Z} \right)}{\sigma_{all}} = 611$$

#### Pinion tooth wear

$$\sigma_{c_p} = Z_e \sqrt{W^t K_o K_v K_s \frac{K_H}{d_w b} \frac{Z_R}{Z_I}} = 2 \times 10^{12} \text{ Pa}$$

$$S_{H_p} = \frac{\left( \frac{S_C Z_N}{Y_0 Y_Z} \right)}{\sigma} = 8.44 \times 10^{-5}$$

### Gear tooth wear

$$\sigma_{c_g} = \left[ \frac{K_{sg}}{K_{sp}} \right]^{\frac{1}{2}} = 2 \times 10^{12} Pa$$

$$S_{Hg} = \frac{(S_c Z_N Z_w)}{Y_0 Y_z} = 3.73 \times 10^{-5}$$

For pinion, we compare  $S_{F_p}$  with  $(S_{Hp})^2$  or 605.7 with  $(8.44 \times 10^{-5})^2 = 7.12 \times 10^{-9}$ , so the threat in the pinion is from wear. For the gear, we compare  $S_{F_g}$  with  $(S_{Hg})^2$  or 611 with  $(3.73 \times 10^{-5})^2 = 1.39 \times 10^{-9}$ , so the threat in the gear is also from wear.

### 3.5 Tools

The project involves Microsoft Excel Solver which is an additional function of the software for simulation purposes. Formulas for the simulation was created and constraints were set to guide the Excel Solver in calculation .The user only need to insert values on the yellow-color box. Only certain values need to be inserted while others will be calculated via the software .The software will compute random numbers for the calculation for optimization of design parameters objective which is to minimize the volume. At the current stage, only Microsoft Excel Solver is involved in the project. The software serve as simulation tool to purposes suitable value of design variables such as diameters of each of the shaft section using De-Goodman analysis , De-Gerber analysis, De-Soderberg analysis and De-ASME Elliptic analysis on using different material with their own characteristics. The simulation aims to optimize the volume of the shaft.

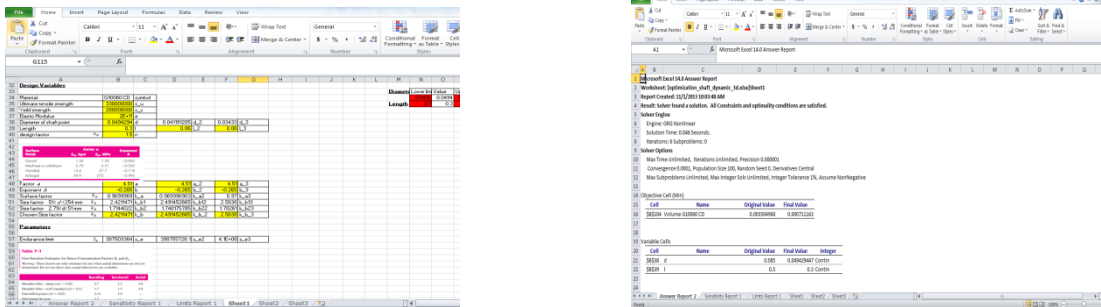

Figure 3.5.1 Shaft Excel Simulations

For gear mechanism, Microsoft Excel Solver compute and purposes the optimal design parameters of the gear that follow 3:1 ratio to minimize the volume .The software serves as a simulation tool to find optimal value of design variables to make sure the bending safety factor of the gear tooth is greater than the wear factor of the gear tooth. This is to ensure the gear will not fail during operation rather than fail due to end of service life.

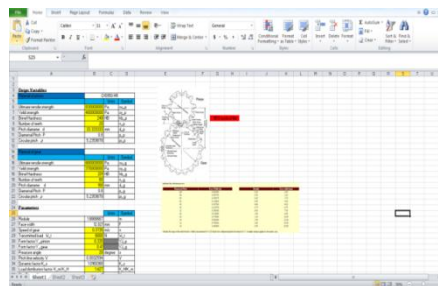

Figure 3.5.2 Gear Excel Simulations

# CHAPTER 4: RESULT AND DISCUSSION

## 4.1 Result and Discussion

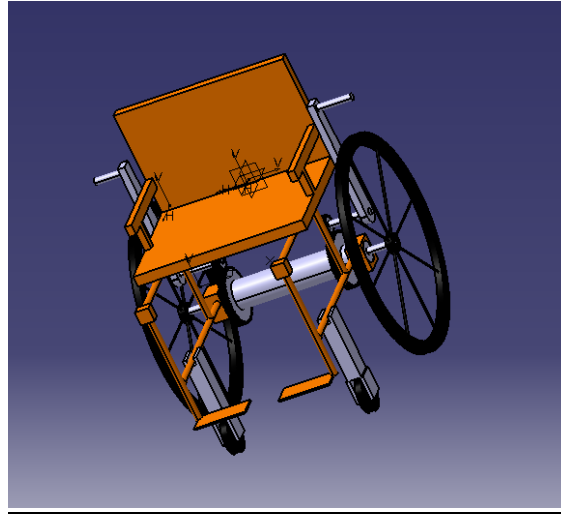

Figure 4.1.1 CAD drawing of Wheelchair

A simulation was done to aid in the selection of the shaft design. 5 different steel alloys were selected which have different mechanical properties. The materials and their mechanical properties as below:

Table 4.1.1 Shaft Simulation Material

Material	Tensile Strength (MPa)	Yield Strength (MPa)	Elastic Modulus (GPa)
AISI 1006 CD	330	285	205
AISI 1015	386.1	284.4	200
AISI 1021	370	310	205
AISI 1081 CD	450	310	200
AISI 1060 ANNEALED	625	370	205

The data was inserted into the simulation Excel of the shaft optimization. Each material's mechanical properties was inserted one by one and a constant parameter of  $D_1 = 85mm$  and  $L_1 = 500mm$  that was obtained from the mathematical modeling was used as base value of all the simulations .A graph of optimal diameter of the center shaft as well as volume was plotted based from the results obtained .The material was arranged based on their tensile strength in increasing order.

Based from the Figure 4.1.2, it can be observed that material AISI 1006 CD has the biggest diameter value while AISI 1060 Annealed has the smallest diameter value. As in Table 4.1.1, AISI 1006 CD has less tensile strength and yield strength compare to AISI 1060 Annealed which explained the graph on Figure 4.1.2 that the optimal volume of shaft using material AISI 1060 Annealed is the lowest. Since the material of the shaft is better than AISI 1006 CD, it will require less volume or material usage for it to withstand the load applied .Even though it is much better to use material with higher values of tensile strength and yield strength, the cost factor also need to be taken account also. The better the properties of the material, the higher the cost.

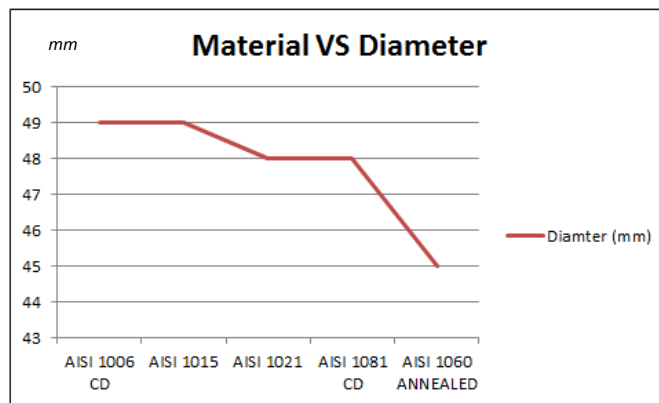

Figure 4.1.2 Material VS Diameter of Shaft



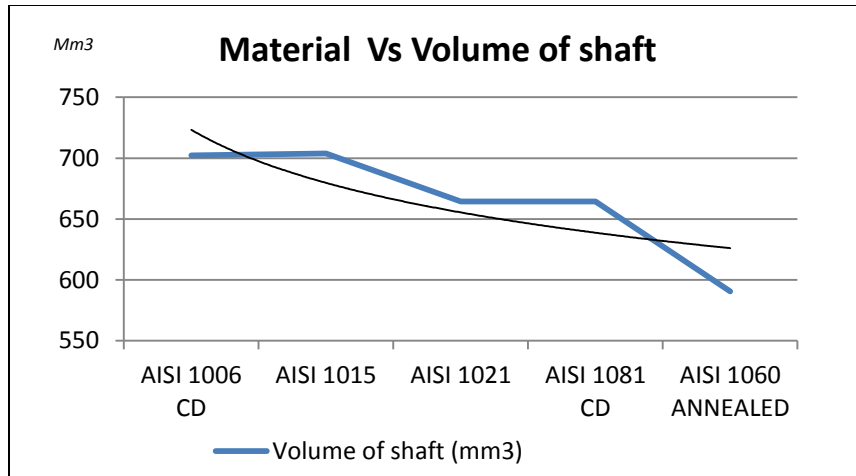

Figure 4.1.3 Material VS Volume of Shaft

Apart from that, each material in Table 4.1.1 undergoes simulation on De-Goodman, De-Gerber, De-ASME Elliptic and De-Soderberg stress analysis to find the optimal diameter.

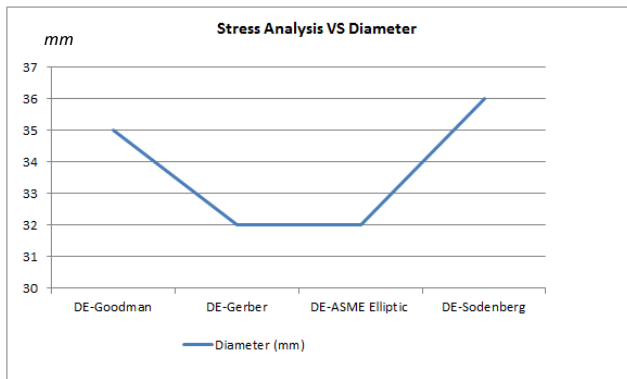

Figure 4.1.4 AISI 1006 CD

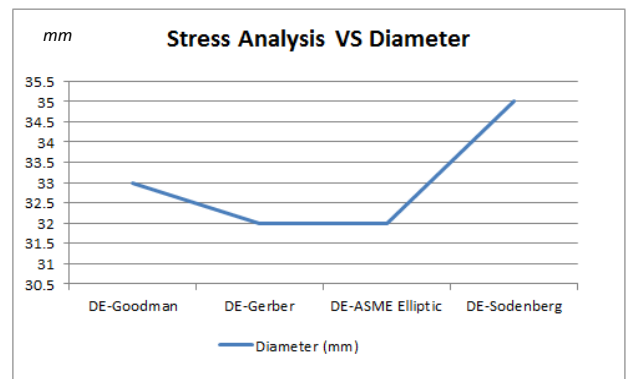

Figure 4.1.5 AISI 1015

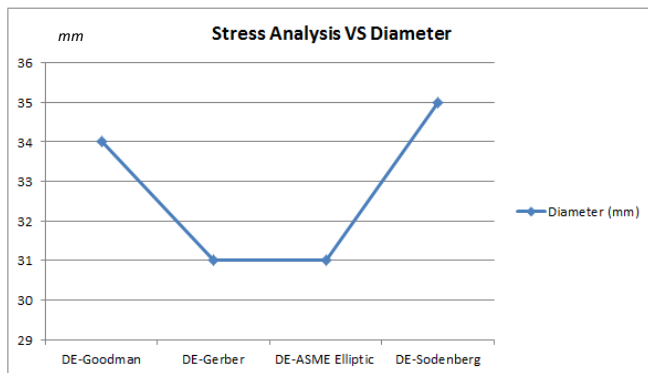

Figure 4.1.6 AISI 1081 CD

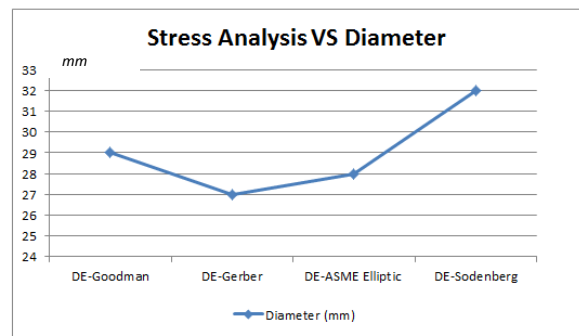

Figure 4.1.7 AISI 1060 ANNEALED

Based from Figure 4.1.4, Figure 4.1.5, Figure 4.1.6, and Figure 4.1.7, the Goodman analysis value of the diameter is 29-35 mm, Gerber 27-32 mm, ASME Elliptic 28-31 mm and Sodenberg 32-35 mm. Figure 14 which is AISI 1060 Annealed as material shows the smallest value of diameter compare to others. This is due to its higher values of mechanical properties which can withstand load applied with little volume.

As for gear design, several simulation was conducted using 7 materials as below:

Table 4.1.2 Gear Simulation Properties

Material	Tensile Strength (MPa)	Yield Strength (MPa)	Brinell Hardness
Wrought Aluminum 2017	179	70	45
Wrought Aluminum 3004	234	186	63
Cast Aluminum 3190	248	165	80
AISI 8620	635	360	183
Steel 610600 HR	680	370	201
Steel G10950 HR	830	460	248
Steel C45	580	460	255

The data was inserted into the simulation Excel of the gear optimization. Each material's mechanical properties were inserted one by one and a constant parameter of  $ratio = 3$  and constant initial values of pinion and gear diameter  $D_p = 50mm$   $D_g = 150mm$ , that were obtained from the mathematical modeling. A graph of optimal diameter of the center shaft as well as volume was plotted based from the results obtained. The material was arranged based on their Brinell hardness in increasing order.

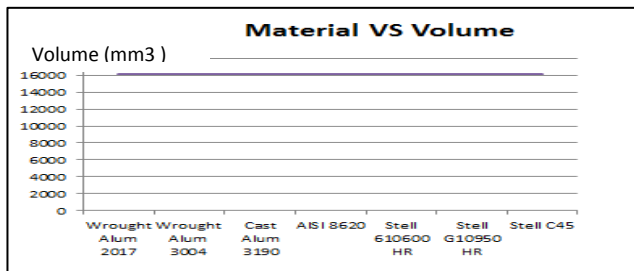

Figure 4.1.8 Material VS Volume Gear

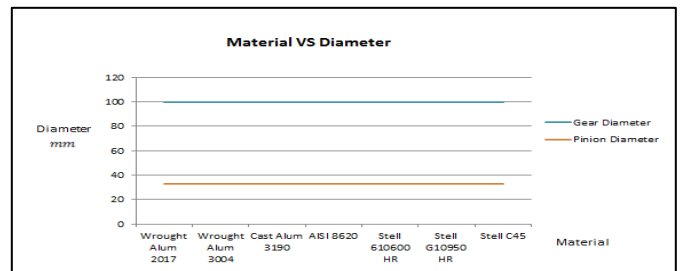

Figure 4.1.9 Material VS Diameter Gear

Based from the Figure 4.1.8 and Figure 4.1.9, all the output values of the volume and diameter are of the same considering different type of material used. This is insensitive effect. Type of material used to design the gear does not influence the performance as long as the gear tooth can withstand the bending stress during operation and does not fail.

## 4.2 Case Study

Three case studies were conducted to test the validation of the simulation for both shaft simulation and the gear simulation.

### 4.2.1 Case study 1 : Question 7.1 in *Shigley's Mechanical Engineering Design, 8<sup>th</sup>*

A shaft design problem was taken from the reference book in order to check the validity of the simulation. The simulation was run under the given values of the question. The end result was compared with question answer.

Table 4.2.1 Case Study 1 Values

Analysis type	Validation (mm)	Present studies (mm)	Percentage different (%)
De Gerber	25.8064	23.693368	8.188015376
ASME Elliptic	25.7048	25.709571	0.018557291
Soderberg	27.686	27.690866	0.017572582
Goodman	27.2542	27.250234	0.014551886

Only De –Gerber value deviate 8.2% from the validation values. This might be caused due to the different values used to calculate stress-concentration factors.

### 4.2.2 Case study 2: Example 1 from Mechanical Engineering Design (MCB3083) – Shaft slide

A similar question as case study 1 to prove the validation of the shaft simulation. The end result was compared with question answer.

Table 4.2.2 Case Study 2 Values

Analysis type	Validation (mm)	Present studies (mm)	Percentage different (%)
De Gerber	25.85	23.438439	9.329056093
ASME Elliptic	25.77	25.768956	0.004051222
Sodenberg	27.7	27.696013	0.014393502
Goodman	27.27	27.269835	0.000605061

Only De –Gerber value deviate 9.3% from the validation values. This might be caused due to the different values used to calculate stress-concentration factors.

#### 4.2.3 Case study 3 : Question 14-1 in *Shigley's Mechanical Engineering Design, 8<sup>th</sup>*

A gear design problem was taken from the reference book in order to check the validity of the simulation. The task was to check the bending stress of the designed gear based from the parameters given under certain working condition. The simulation was run under the given values of the question. The end result was compared with question answer.

Table 4.2.3 Case Study 3 Values

	Validation (Pa)	Present studies (Pa)	Percentage different
Gear	29698.7	28630.6665	3.596229801

The bending stress exerted on the gear tooth was 3.6% different from the validation results. This may be resulted from the different factor design used by the simulation compare to the question such as the AGMA standard of factors in manufacturing with the theoretical factors.

## CHAPTER 5: CONCLUSION

The shaft mechanism and the gear mechanism affect each other in both design and operation. In order to produce optimal design of mechanism, the shaft and gear mechanism, each must be optimized in terms of design specifications and material selection. The shaft mechanism and the gear mechanism research have been done extensively by researchers to improve its design and capabilities because of its application in almost all of the equipment and machines nowadays. This research also aims to improve the designing process of the shaft and gears mechanism by producing optimal design of drive mechanism not just in wheelchair drive mechanism but other application as well by serving as an aid tool for designers.

Based from the results of the simulation on the shaft mechanism and gear mechanism, material selection plays an important role in defining the results of the optimization. For shaft mechanism, strength as well as the capability of the material determines the design of the shaft itself. The higher the material properties, the higher the design resistant against failure. Although, by choosing a better or higher grade material for design, the cost of manufacture that need to be bear will be substantially high compared to choosing between lower grade material that will not meet the objective of optimization. Moreover, for gear mechanism, material selection is does not play a major influence in design process as long as the material chosen for the gear does not fail the gear tooth during operation. This is because, gear act as torque transmission device whether to increase the torque or decrease it by a given ratio. Material selection for gear is to make sure that the gear will not fail due to bending stress and can last longer with higher rotation life.

The recommendation that would be suggested to improve this project is to create better interface for users in selecting types of simulation criteria of optimization that will ease the process. Moreover, more simulation work must be run in order to find the more weaknesses of the simulation and improve it into a better tool aid in designing optimal shaft and gear mechanism.

## *References*

1. L.Zhang,Xi Feilong.(2012).An Optimization Design for the Stair-Climbing Wheelchair. Master's Degree Thesis in Blekinge Institute of Technology , Karlskrona, Sweden.
2. <http://www.disabled-world.com/assistivedevices/mobility/wheelchairs/manual/>  
(Accessed : 2013 June 24)
3. [http://en.wikipedia.org/wiki/Drive\\_shaft](http://en.wikipedia.org/wiki/Drive_shaft) (Accessed : 2013 June 24)
4. Mendia F., Bařkalb T., Borana K., Boranc F. M..(2003). Optimization of Module, Shaft Diameter and Rolling Bearing for Spur Gear through Genetic Algorithm. Expert Systems with Applications: 8058–8064.
5. Rao B. R., Tiwari R.. (2007). Optimum Design of Rolling Element Bearings Using Genetic Algorithms. In Mechanism and Machine Theory : 233-255.
6. Kimb Y., Tanb A. , Yangc B.,Kimd W. C.(2007).Optimum Shape Design of Rotating Shaft by ESO Method. Journal of Mechanical Science and Technology 21:1039-1047.
7. <https://en.wikipedia.org/wiki/Gear> (Accessed : 2013 June 24)
8. Baglioni S., Cianetti F.,Landi L..(2012).Influence of The Addendum Modification on Spur Gear Efficiency. In Mechanism and Machine Theory: 216-233.
9. Li S., Kahraman A..(2013).A Tribo-Dynamic Model of a Spur Gear Pair. Journal of Sound and Vibration.
10. Xu H.(2005).Development of A Generalized Mechanical Efficiency Prediction Metrology for Gear Pairs.Ph.D. Thesis.
11. Pedersen,N.L.(2010).Improving Bending Stress in Spur Gears Using Asymmetric Gears and Shape Optimization. In Mechanism and Machine Theory Volume 45 : 1707-1720.
12. Mr Steve. (2011, April 22). Re: Human values of Force ? [Online forum comment].  
<https://forum.solidworks.com/message/221384>
13. Jasbir S.A..(2004) Introduction to Design. Introduction to Optimal Design.
14. Stocki R., Zolc T. , Tazowski R. ,Knabel J..(2011) Robust Design Optimization of The Vibrating Rotor-Shaft System Subjected to Selected Dynamic constraints. Mechanical Systems and Signal Processing.

15. Abbas M., Yahaya S.H., Majid A. , Jamaludin.(2012) Spur Gear Tooth Design with S-Shape Transition Curve Using T-Bezeir Function.International Conference on Advances Science and Contemporary Engineering 2012.
16. Keith J., Budyynas G..(2008) Shigleys Mechanical engineering Design 8<sup>th</sup>
17. <http://my.misumi-ec.com/asia/ItemDetail/10300428250.html> (Accessed : 2013 October 24)
18. <http://wwweng.uwyo.edu/commend/Sgdc/help/> (Accessed : 2013 October 24)
19. <http://www.azom.com/article.aspx?ArticleID=6537> (Accessed:2013 October 24)
20. [http://www.efunda.com/materials/alloys/ally\\_steels](http://www.efunda.com/materials/alloys/ally_steels) (Accessed : 2013 November 13)

