

**INFLUENCE OF INFLOW-OUTFLOW SYSTEMS
FOR NATURAL MIXING IN A RETENTION POND**

by

WAN NORGAYAH BINTI WAN MOHD NOOR
15130

Dissertation submitted in partial fulfillment of
the requirements for the
Bachelor of Engineering (Hons)
(Civil)

MAY 2014

Universiti Teknologi PETRONAS
Bandar Seri Iksandar
31750 Tronoh
Perak Darul Ridzuan

TABLE OF CONTENTS

| | |
|--|----|
| LIST OF TABLES | 4 |
| ABSTRACT | 5 |
| CHAPTER 1: INTRODUCTION | 6 |
| 1.1 Background of Study | 6 |
| 1.2 Problem Statement | 6 |
| 1.3 Objective | 7 |
| 1.4 Scope of Study | 7 |
| CHAPTER 2: LITERATURE REVIEW | 8 |
| 2.1 Retention Pond | 8 |
| 2.2 Mixing Characteristics | 11 |
| 2.3 Sedimentation | 14 |
| 2.4 Type of Inflow | 14 |
| 2.5 Total Suspended Solids | 15 |
| CHAPTER 3: METHODOLOGY | 16 |
| 3.1 Design Criteria | 16 |
| 3.2 Experimental Set-up | 17 |
| 3.3 Experimentation | 18 |
| 3.4 Gantt Chart and Key Milestone | 22 |
| CHAPTER 4: RESULTS AND DISCUSSION | 23 |
| CHAPTER 5: CONCLUSION AND RECOMMENDATION | 34 |
| 5.1 Conclusion | 34 |
| 5.2 Recommendations | 34 |
| REFERENCES | 35 |
| APPENDICES | 36 |
| Appendix 1 | 36 |
| Appendix 2 | 36 |
| Appendix 3 | 37 |
| Appendix 4 | 37 |

Appendix 5..... 38
Appendix 6..... 38
Appendix 7..... 39
Appendix 8..... 39
Appendix 9..... 40

LIST OF FIGURES

| | |
|--|----|
| Figure 1 Mechanism of Stormwater Runoff (Google Images) | 8 |
| Figure 2 Simplest Case of Inlet Stormwater without Unit for Remediation [4]..... | 8 |
| Figure 3 Typical Detention Ponds [5]..... | 9 |
| Figure 4 Pooling and Mixing at the Plunge Point [6] | 11 |
| Figure 5 Schematic of the Mixing Processes in a Lake [10] | 12 |
| Figure 6 Mixing in a Rectangular Tank [2]..... | 13 |
| Figure 7 Mixing in a Circular Tank [2]..... | 13 |
| Figure 8 Mechanism of Sedimentation | 14 |
| Figure 9 Rectangular Pond | 16 |
| Figure 10 Circular Pond | 16 |
| Figure 11 Side View of Experimental Set-up (not to scale)..... | 17 |
| Figure 12 Plan View of Experimental Set-up (not to scale)..... | 17 |
| Figure 13 Samples of Water | 21 |
| Figure 14 Filter Paper..... | 21 |
| Figure 15 Filtering Flask | 21 |
| Figure 16 Graph of TSS vs Time for I1O1..... | 23 |
| Figure 17 Graph of TSS vs Time for I2O1..... | 24 |
| Figure 18 Graph of TSS vs Time for I3O1..... | 24 |
| Figure 19 Graph of TSS vs Time for I3O2..... | 25 |
| Figure 20 Graph of TSS vs Time for I1O2..... | 26 |
| Figure 21 Graph of TSS vs Time for I3O1..... | 26 |
| Figure 22 Graph of TSS vs Time for Inlet 1 | 28 |
| Figure 23 Graph of TSS vs Time for Inlet 2 | 30 |
| Figure 24 Graph of TSS vs Time for Inlet 3 | 32 |

LIST OF TABLES

| | |
|---|----|
| Table 1 Advantages and Disadvantages of a Retention Pond | 10 |
| Table 2 Mixing Mechanism..... | 12 |
| Table 3 Advantages and Disadvantages of a Rectangular and Circular Pond | 16 |
| Table 4 Design of Variables | 18 |
| Table 5 Gantt Chart and Key Milestone of Project..... | 22 |
| Table 6 Percentage Difference for Collection Point X and Outlet | 25 |
| Table 7 Flowrate for Each Variables | 27 |
| Table 8 Mixing Effective Region Inside Inlet 1 | 29 |
| Table 9 Mixing Effective Region Inside Inlet 2 | 31 |
| Table 10 Mixing Effective Region Inside Inlet 3 | 33 |

ABSTRACT

A retention pond is used to temporarily store and control stormwater runoff. The importance of a retention pond is that it reduces flood peak discharge by temporary storage and gradually release from its outlet. It is also designed with an inlet and outlet system that also produces a natural mixing inside the pond. However, there has not been any written procedure that explains which inflow and outflow orientation is the best in producing effective natural mixing.

This research is conducted to identify the influence of inflow and outflow orientation in creating an effective natural mixing inside of a circular tank which acts as a retention pond. The research uses an experiment approach by using a constant flowrate, with a variable of nine different inflow and outflow orientation. The results were compared base on Total Suspended Solid (TSS) test. From that, it was found that the lowest level of inflow (I_1) and highest level of outflow (O_3) gave the best result in producing effective natural mixing.

CHAPTER 1: INTRODUCTION

1.1 Background of Study

A stormwater retention pond is used to store excess stormwater runoff for a certain period of time before releasing it to the environment. This is to prevent flood from occurring especially at the urban areas where there are poor drainage system. The mixing occurring inside the pond is one of the critical components of a distribution system and can pose a significant challenge when it gives a negative impact on the environment [1].

This project discuss on the influence of different inflow and outflow configuration inside a retention pond. The experiment will be conducted in a laboratory where mixing will be carried out in a circular tank which will act as the retention pond. The result will be based on the Total Suspended Solids test.

1.2 Problem Statement

A retention pond is practically used for retaining storm water momentary before releasing it using a control outlet. There are studies regarding enhance mixing in a retention pond for example by using a RainJet which is a man-made device [2], however there has not been a critical study on inflow and outflow mechanism and how it affects mixing characteristics of inflows into a retention pond which is a natural event.

By creating a natural mixing occurrence in the retention pond with the purpose of cleaning or reducing the sediments in the pond, the result gain would be beneficial to the authority involved because it would be environmentally friendly and relatively cheap which would be practical to be implemented. Although there is an Urban Stormwater Management Manual for Malaysia (MSMA 2nd Edition) which is provided by the Department of Irrigation and Drainage, Government of Malaysia but MSMA does not properly describe the effect of inflow-outflow orientation inside a retention pond.

1.3 Objective

The aim of this project is:

1. To experimentally study and design an inflow-outflow system for natural cleaning of a retention pond.
2. To measure the quality of water in the retention pond at different times by means of Total Suspended Solids test.
3. To analyse the influence of different inflow and outflow configuration inside a retention pond by means of its Total Suspended Solids (TSS) test.

1.4 Scope of Study

1. To study the performance of different inflow-outflow configuration inside the circular pond and identify which configuration is the best in producing most effective natural mixing under a flowrate range of 1.305×10^4 until 1.341×10^4 m³/s.
2. The measure of mixing herein is by the amount of TSS that is removed because it is consider as the most effective way of mixing.
3. The after-effect of the experiment such as post-sedimentation is not considered because this research is focusing on natural mixing inside the circular tank.

Hypothetically, by logic people can simply assume which orientation is the best but experiments have never showed that. This technical result through experiment is to support whether the hypothesis or assumptions made by the people are true or untrue.

CHAPTER 2: LITERATURE REVIEW

2.1 Retention Pond

A retention pond is actually a basin that is designed to provide stormwater reduction and catch runoff water from higher elevation areas [3]. The stormwater runoff will be temporarily stored in a retention pond before distributing to the nearby rivers. In other words, the retention pond dampens the flow of the stormwater runoff before going to the river. Figure 1 below shows the mechanism of the stormwater runoff entering the retention pond before going to a river through a pipe and Figure 2 shows a simplest case of inlet stormwater without unit for remediation.

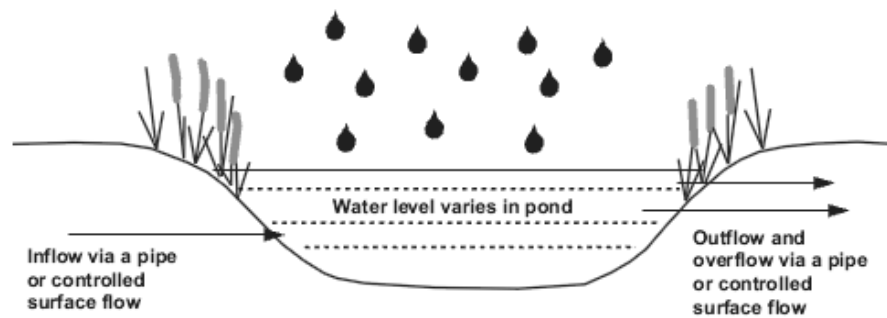

Figure 1 Mechanism of Stormwater Runoff (Google Images)

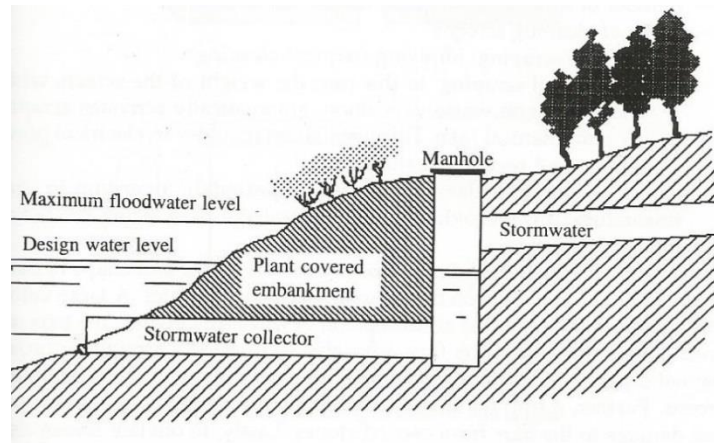

Figure 2 Simplest Case of Inlet Stormwater without Unit for Remediation [4]

A retention pond is similar to a wet-detention pond because it retains water at a certain level inside the pond. The design of a retention pond or a wet-detention pond is provided in the MSMA provided by the Department of Irrigation and Drainage, Malaysia. Based on the MSMA, the design criteria of a detention pond that is not classified as dams must be design with the following aspects that had been lined by them:

- a) Pond Water Depth
- b) Embankment Top Widths
- c) Side Slopes
- d) Bottom Grades
- e) Freeboard

An example of typical detention ponds in Malaysia from MSMA are shown in Figure 3.

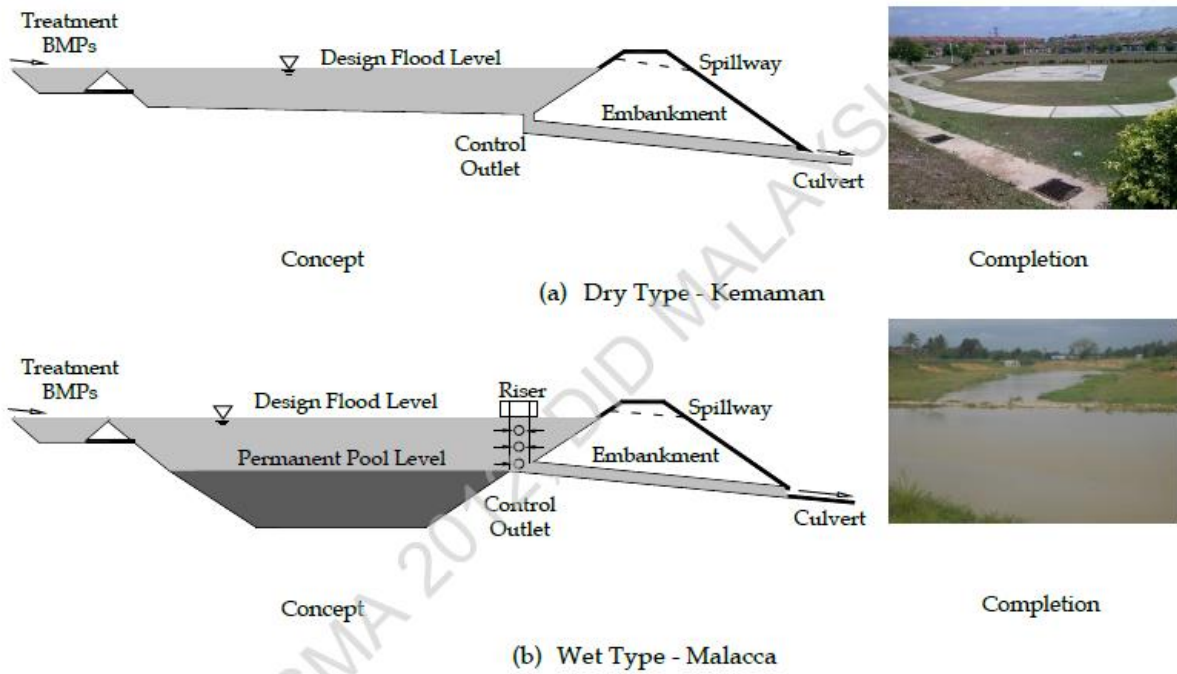

Figure 3 Typical Detention Ponds [5]

Other than catching runoff from higher elevation areas and to retain stormwater, the retention pond also has other advantages and disadvantages of its own. Table 1 shows some of the advantages and disadvantages of a retention pond;

Table 1 Advantages and Disadvantages of a Retention Pond

| Advantages | Disadvantages |
|--|---|
| <ul style="list-style-type: none"> • Can cater for all storms • Good removal capability of urban pollutants • Can be used where groundwater is vulnerable, if lined • Good community acceptability • High potential ecological, aesthetic and amenity benefits • May add value to local properties | <ul style="list-style-type: none"> • No reduction in runoff volume • Anaerobic conditions can occur without regular inflow • Land take may limit use in high density sites • May not be suitable for steep sites, due to requirement for high embankments • Colonization by invasive species could increase maintenance • Perceived health and safety risks may result in fencing and isolation of the pond |

2.2 Mixing Characteristics

Mixing occurs when the initial energy of an inflow into a reservoir pushes the more stationary lake water ahead of it. The inflow continues to push the lake water ahead until the initial momentum is substantially dissipated by river bottom shear forces and by the pressure gradient across the interface between the water masses [6]. The turbulent kinetic energy of the inflow is usually sufficient to keep the water completely mixed vertically to prevent the settling of some materials [6]. Figure 4 shows a plunge point and separation point move upstream and downstream defining transition zone.

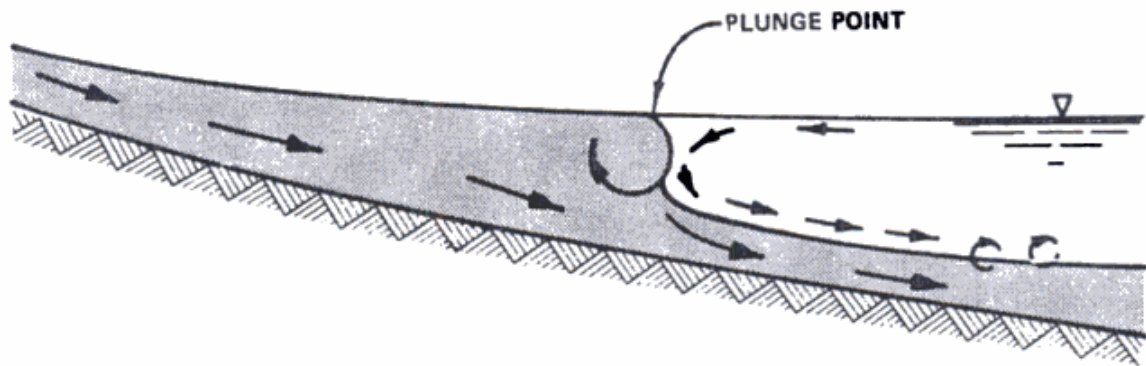

Figure 4 Pooling and Mixing at the Plunge Point [6]

Hydrodynamics

It is the study of fluids in motion. Precisely, it studies at the ways different forces affect the movement of liquids. A series of equations explain how the conservation laws of mass, energy, and momentum apply to liquids, particularly those that are not compressed [7].

Velocity

It is a vector quantity referring to the rate of which an object changes its position or in easier term it is speed with direction. In order to maximize the velocity, a person for example must make a big effort to maximize the amount that they are displaced from their original position and must never change directions and begin to return to the starting point because it is a vector quantity [8].

Turbidity

Turbidity is the cloudiness or haziness of a fluid caused by suspended solids that are generally invisible to the naked eye. Fluids can contain suspended solid matter consisting of particles of many different sizes. While some suspended material will be large enough and heavy enough to settle rapidly to the bottom of the container if a liquid sample is left to, very small particles will settle only very slowly or not at all if the sample is regularly agitated or the particles are colloidal. These small solid particles cause the liquid to appear turbid [9].

Table 2 below shows mixing mechanism according to different types of ponds and conditions.

Table 2 Mixing Mechanism

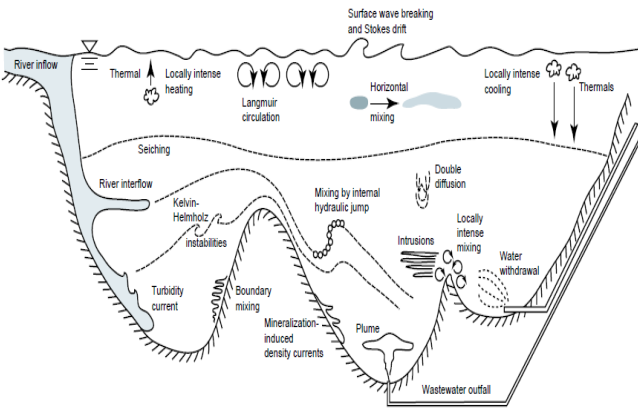
| Authors | Mixing Characteristics | Remarks / Outcome |
|---------|--|--|
| [10] |  <p>Figure 5 Schematic of the Mixing Processes in a Lake [10]</p> | <ul style="list-style-type: none"> • Wind is responsible for waves and currents which is the dominant energy for mixing. • Boundaries are vital due to the shear that develops between the ambient flow and non-slip condition. • Inflow and outflow create kinetic energy. |

[2]

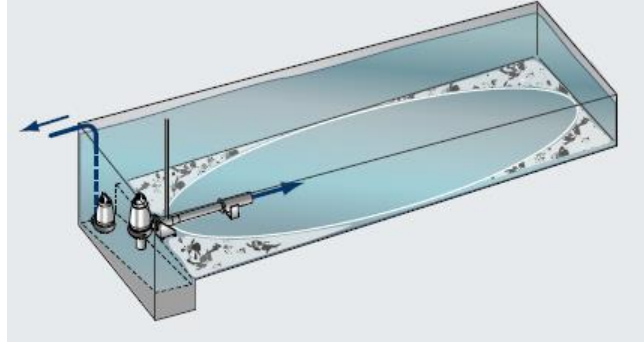

Figure 6 Mixing in a Rectangular Tank [2]

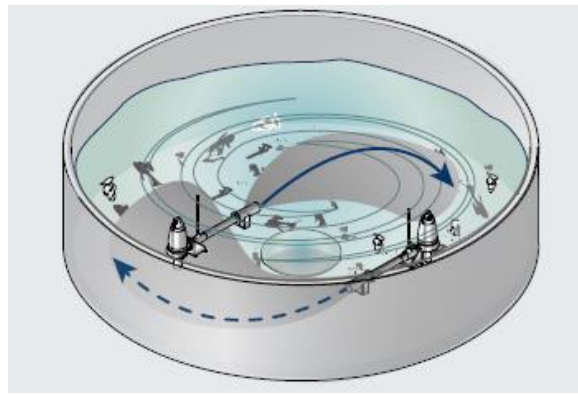

Figure 7 Mixing in a Circular Tank [2]

Rectangular Tank
The RainJet ensures that the side walls and the centre area of the tank floor are kept free from deposits due to the mixing force provided by the installed equipment.

Circular Tank
RainJet will start building the inertia of the circular movement which will clean the stormwater tank.

2.3 Sedimentation

It is the natural process in which materials such as stone and sand is carried to the bottom of a body of water and forms a solid layer as shown in Figure 5 below. This is due to their motion through the fluid in response to the forces acting on them. These forces can be due to gravity, centrifugal acceleration or electromagnetism.

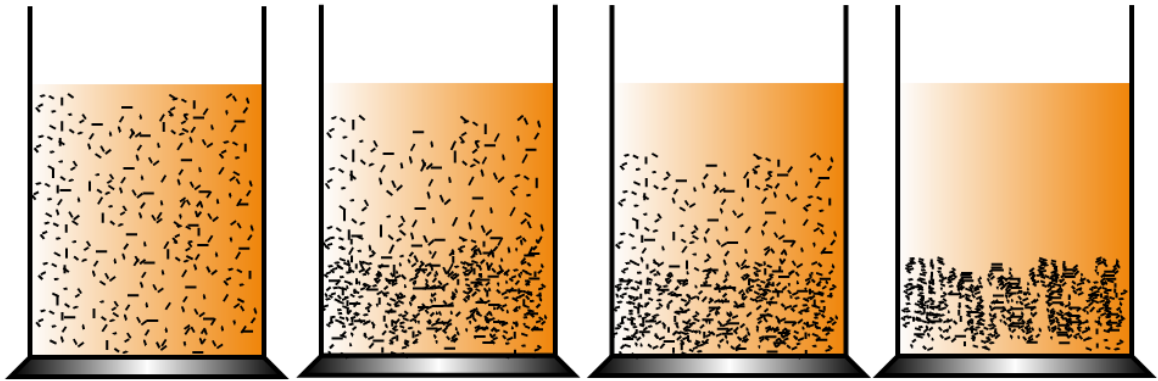

Figure 8 Mechanism of Sedimentation

2.4 Type of Inflow

Runoff

When rain or snow falls onto the earth, it moves according to the laws of gravity. A portion of the precipitation seeps into the ground to replenish groundwater. However, most of it flows downhill as runoff. Runoff is extremely important because it keeps rivers and lakes full of water, but it also changes the landscape by the action of erosion. Runoff occurs during storms, and much more water flows in rivers during storms.

2.5 Total Suspended Solids

Total suspended solids (TSS) are from the influence of suspended particles in a water body causing its turbidity and transparency [11]. The TSS is solids that are present in water that can be trapped by a filter. It includes varieties of materials which makes it a problem when it is highly concentrated in water.

CHAPTER 3: METHODOLOGY



In this chapter the research methodology used in the study is described. The design criteria for the shape of pond chosen for the study are described. The experimental set-up and experimentation, including the TSS test that was carried out are described.

3.1 Design Criteria

Shape of Pond

The typical concrete design for a retention pond is usually rectangular and circular. However, to achieve the significant degree of control over pond shape and dimensions is hard because of the needs of taking the natural topographic of the site into considerations. In order to choose the suitable shape of the pond for the experiment, Table 3 shows the advantages and disadvantages of a rectangular and a circular pond.

Table 3 Advantages and Disadvantages of a Rectangular and Circular Pond

| Type of Pond | Advantages | Disadvantages |
|--|--|---|
|  <p style="text-align: center;">Figure 9 Rectangular Pond</p> | <ul style="list-style-type: none"> • Better use of land. | <ul style="list-style-type: none"> • Problems with removal of waste. • Difficult to clean. • Poor mixing especially at the corner of the tank. |
|  <p style="text-align: center;">Figure 10 Circular Pond</p> | <ul style="list-style-type: none"> • Good mixing of the water. • High ratio of tank volume. • Can be used to rapidly concentrates and remove settleable solids. | <ul style="list-style-type: none"> • Poor use of land area. |

Based on Table 3, it is preferably to use the circular pond because it has higher mixing efficiencies compared to rectangular tank.

3.2 Experimental Set-up

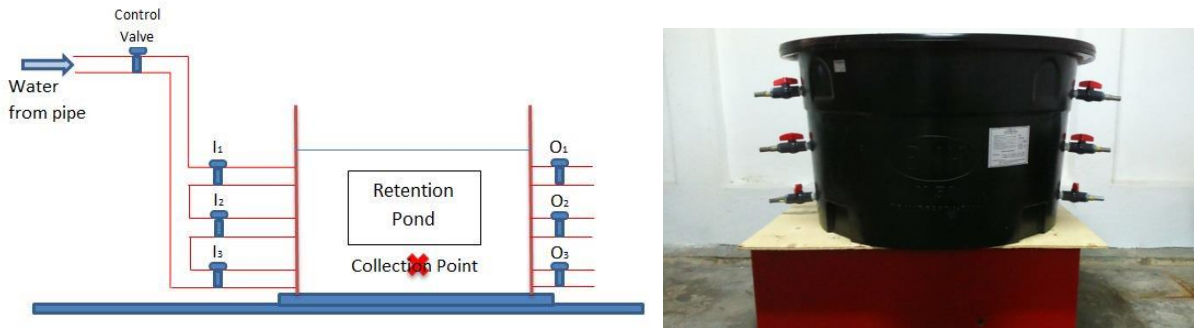

Figure 11 Side View of Experimental Set-up (not to scale)

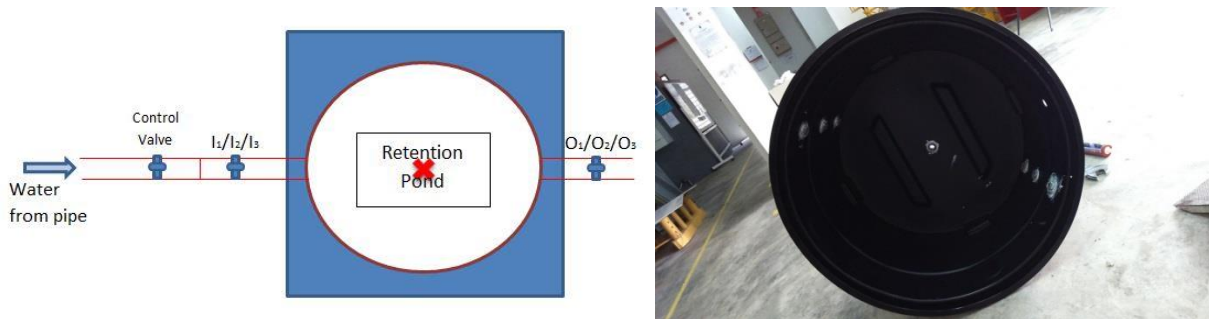

Figure 12 Plan View of Experimental Set-up (not to scale)

In the configuration shown in Figure 6 and 7, three inlet levels were studied. Three different outlet levels were also designed to study its influence in natural mixing.

3.3 Experimentation

3.3.1 Inlet and Outlet Configuration System

The inlet and outlet are positioned in three different levels of inlets and outlets as shown in Figure 6 and 7. The design experiments were planned based on Table 4 and according to the proposed experimental set-up:

Table 4 Design of Variables

| Run | Variable Test |
|------------|--------------------------------|
| 1. | I ₁ ,O ₁ |
| 2. | I ₁ ,O ₂ |
| 3. | I ₁ ,O ₃ |
| 4. | I ₂ ,O ₁ |
| 5. | I ₂ ,O ₂ |
| 6. | I ₂ ,O ₃ |
| 7. | I ₃ ,O ₁ |
| 8. | I ₃ ,O ₂ |
| 9. | I ₃ ,O ₃ |

3.3.2 Experimental Procedure

- 1) Open valve I₁ until the desired flowrate is achieved
- 2) Fill the tank to the desired volume
- 3) Pour 1L of kaolin in the tank and mix it well.
- 4) Time starts when the valve O₁ is open
- 5) Collect sample at Collection Point (shown in Figure 6) and outlet at each sampling interval.
- 6) Close the valve O₁ and stop the time.
- 7) Repeat Steps 3 to 6 with variables based on Table 4
- 8) The samples are tested for TSS in the laboratory.

Variables

- Level of inflows
- Level of outflows

Measuring Devices

- Stopwatch

Apparatus

- Beaker
- Bottle sample
- Circular tank (with variables inlets and outlets)

3.3.3 Total Suspended Solids Test

Apparatus/Sample

- i. Samples of water (Figure)
- ii. 47mm filter paper (Figure)
- iii. Filter holder
- iv. Filtering flask (Figure)
- v. Watch glass
- vi. Drying oven
- vii. Desiccators
- viii. Tweezers

Procedures

- 1) Place a 47mm filter disc in the filter holder with the wrinkled surface upward. Note : Always using tweezers to handle filter discs. Fingers add moisture, which subsequently will cause a weighing error.
- 2) Filter 500ml of well-mixed, representative water sample by applying vacuum to the flask. Follow with three separate 10ml washings of deionized water. Note: for greatest accuracy as much sample as possible should be filtered. However, using a sample containing more than 15mg of solids will result in premature plugging of the water sample may have to be adjusted (increased or decreased) to achieve this optimum condition. Several completed tests will show whether any adjustment is necessary.
- 3) Slowly release the vacuum from the filtering system and gently remove the filter disc from the holder. Place the disc on a watch glass. Inspect the filtrate (filtered water in flask) to ensure that proper trapping of solids was accomplished on the disc.
Note: be sure to remove any residue adhering to the sides or bottom lip of the filter holder. A rubber policeman on the end of a stirring rod is very helpful in scrapping this residue loose, and small amounts of deionized water will help wash the residue down the filter disc.
- 4) Again place the watch glass and filter in a drying oven at 103°C for 1 hour.
- 5) Remove the watch glass and filter from the oven, and carefully place in a desiccator. Allow to cool to room temperature.

- 6) Carefully remove the disc from the desiccator and weight to the nearest 0.1mg using an analytical balance.

Note: take extreme care when removing the lid of the desiccator to not disturb the dried suspended matter on the disc. Remove the watch glass and disc from the desiccator as a unit and place beside the analytical balance. Use plastic tweezers to transfer the disc to and from the weighing pan of the balance.

- 7) Return the disc to the watch glass if the mg/L Volatile Non-filterable Residue (VNR) is to be determined. If not, discard the disc. Note: If Volatile Non-filterable Residue also is to be determined, take care not to lose any portion of the suspended matter on the disc.

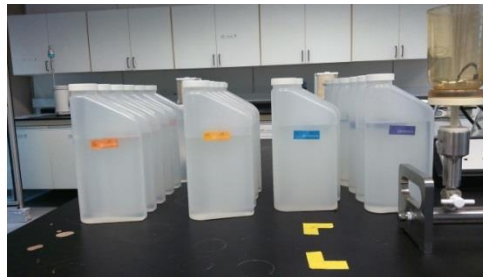

Figure 13 Samples of Water



Figure 14 Filter Paper

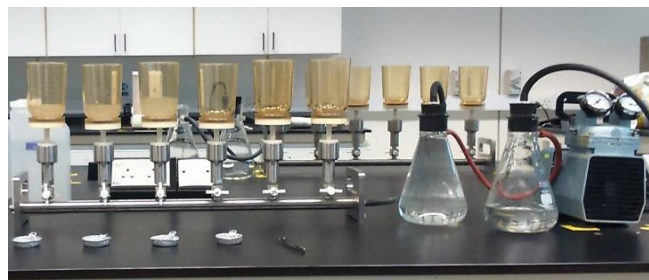

Figure 15 Filtering Flask

3.4 Gantt Chart and Key Milestone

| No. | Detail/ Week | 1 | 2 | 3 | 4 | 5 | 6 | 7 | 8 | 9 | 10 | 11 | 12 | 13 | 14 | 15 |
|-----|---|---|---|---|---|---|---|---|---|---|----|----|----|----|----|----|
| 1 | Project Work Continues | ■ | ■ | ■ | ■ | ■ | ■ | ■ | | | | | | | | |
| 2 | Submission of Progress Report | | | | | | | | ● | | | | | | | |
| 3 | Project Work Continues | | | | | | | | ■ | ■ | ■ | ■ | ■ | | | |
| 4 | Pre-SEDEX | | | | | | | | | | ● | | | | | |
| 5 | Submission of Draft Final Report | | | | | | | | | | | ● | | | | |
| 6 | Submission of Dissertation (soft bound) | | | | | | | | | | | | ● | | | |
| 7 | Submission of Technical Paper | | | | | | | | | | | | ● | | | |
| 8 | Viva | | | | | | | | | | | | | ● | | |
| 9 | Submission of Project Dissertation Hard Bound | | | | | | | | | | | | | | | ● |

- Process
- Suggested Milestone

Table 5 Gantt Chart and Key Milestone of Project

CHAPTER 4: RESULTS AND DISCUSSION

4.1 Comparison Between Sample Collection

Sample collections were taken from inside the tank and outside (outlet) the tank. The samples taken from inside of the tank (collection point X shown in Figure 6) to identify the mixing that occurs in it. The samples were taken at the lowest point inside the tank however it does not reach the bottom of the tank. This is due to decrease of water level based on its respective outlet and to maintain the position where the samples are taken. The duration of time involved in the mixing process is also significant because the longer the mixing occurs, the cleaner the water inside the tank would be.

Samples are also taken from outside of the tank or in other words. If samples inside of the tank indicate the mixing occurring in it, the samples taken outside of the tank indicate the amount of solids that were able to reduce.

Among these two sample collections, the sample collections taken from inside of the tank is higher than from outside of the tank. Samples are given by this collection of graphs for each configuration representation.

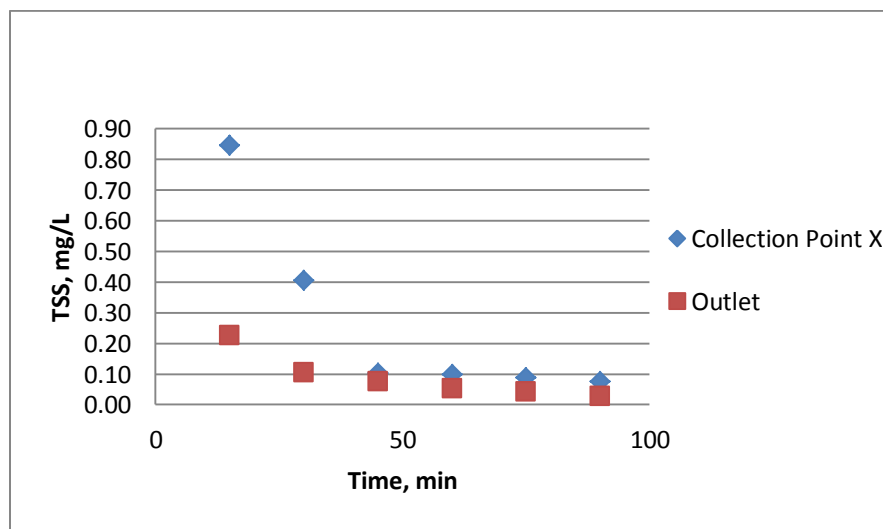

Figure 16 Graph of TSS vs Time for I₁O₁

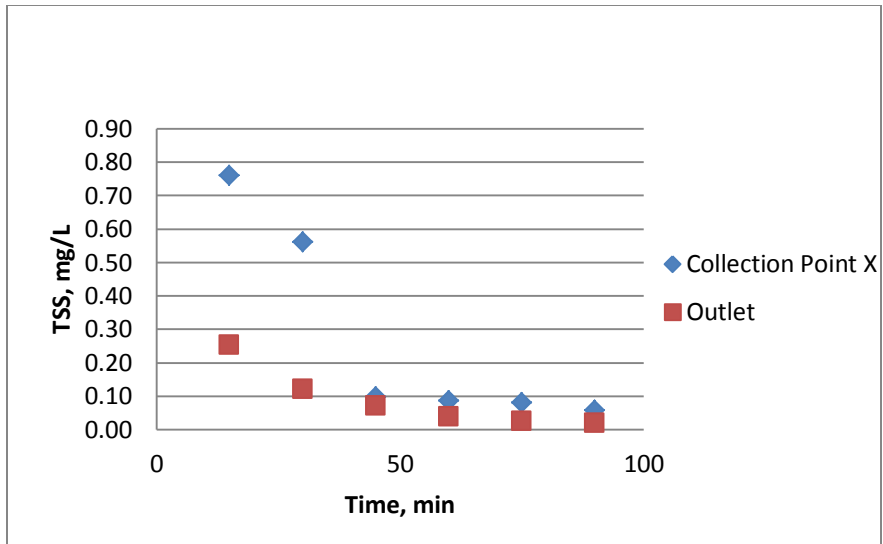

Figure 17 Graph of TSS vs Time for I₂O₁

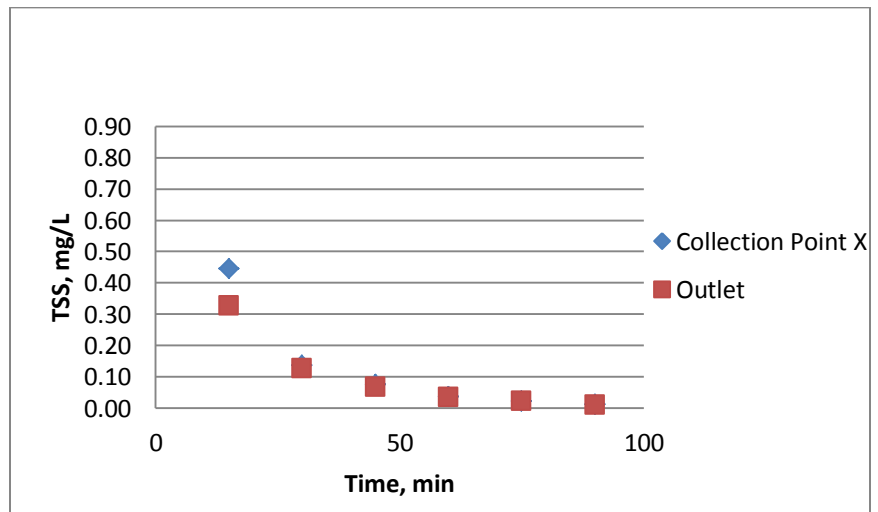

Figure 18 Graph of TSS vs Time for I₃O₁

4.1.1 Percentage Difference for Collection Point and Outlet

Percentage difference for collection point X and outlet are calculated by using the following equation:-

$$\% \text{ Difference} = \frac{\text{Collection Point X} - \text{Outlet}}{\text{Outlet}} \times 100\%$$

Sample calculation:

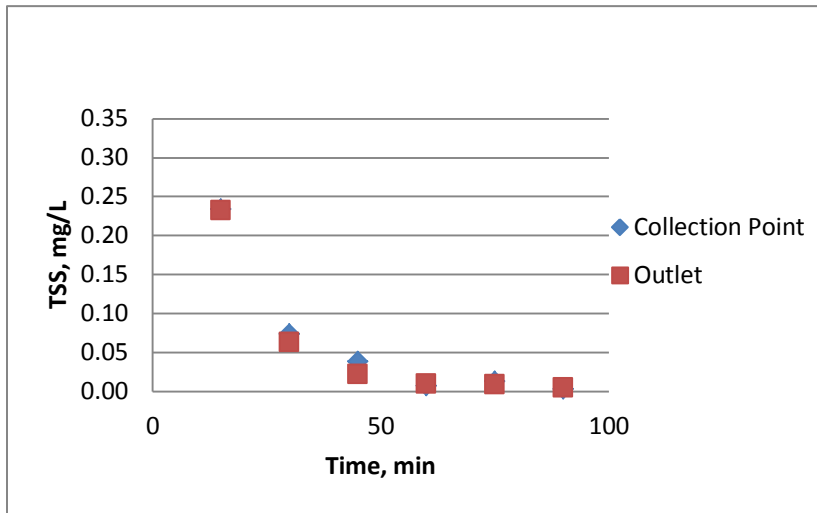

% Difference

$$= \frac{0.2328 - 0.2318}{0.2318} \times 100\% = 0.43\%$$

Figure 19 Graph of TSS vs Time for I₃O₂

Table 6 Percentage Difference for Collection Point X and Outlet

| Outlet \ Inlet | Inlet | | |
|----------------|----------------|----------------|----------------|
| | I ₁ | I ₂ | I ₃ |
| O ₁ | 276% | 201% | 365 |
| O ₂ | 72% | 369% | 0.43% |
| O ₃ | 49% | 28% | 3.10% |

The percentage difference of the tank is ranging from 0.43% to 369.01%.

4.1.2 Time Required for the Experiment to Give Constant Reading

The time interval that is used for the experiment is 15 minutes for duration of 90 minutes. There is a significant decrease shown at the first 45 to 60 minutes duration for most of the experiment where the readings start to become constant (Figure 16). This is because at that period of time the solids (sediments) have settled at the bottom of the tank, making the solids that is discharged from the tank and inside the tank to have consistent and almost close reading. However for I_3O_1 , the readings continue to decrease throughout the 90 minutes duration (Figure 17).

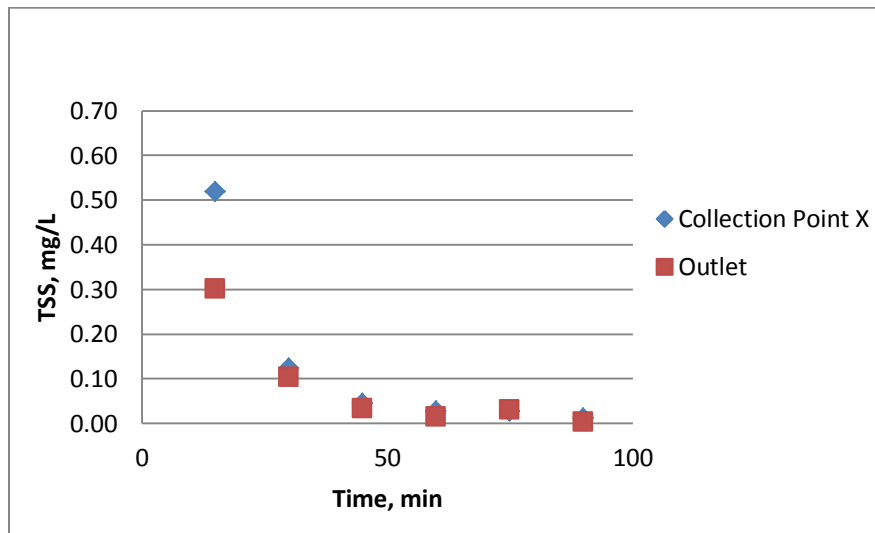

Figure 20 Graph of TSS vs Time for I_1O_2

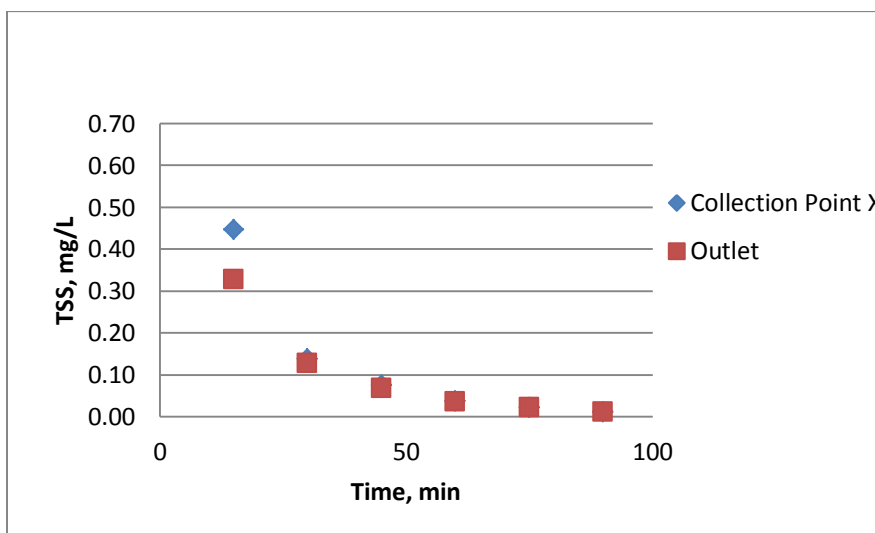

Figure 21 Graph of TSS vs Time for I_3O_1

4.2 Mixing Characteristics

Mixing characteristic is important because it determines the discharge outside the tank. The flowrate that enters the tank were made constant because the flowrate is not part of the variables. The flowrate were calculated by timing the time the water fill the tank for 50 liters for three times and average were taken. The results are as follows:-

Table 7 Flowrate for Each Variables

| I _x O _x | Average Time Taken, s | Flowrate, m ³ /s |
|-------------------------------|-----------------------|-----------------------------|
| I ₁ O ₁ | 380 | 1.316 x 10 ⁻⁴ |
| I ₁ O ₂ | 376 | 1.330 x 10 ⁻⁴ |
| I ₁ O ₃ | 375 | 1.333 x 10 ⁻⁴ |
| I ₂ O ₁ | 373 | 1.340 x 10 ⁻⁴ |
| I ₂ O ₂ | 383 | 1.305 x 10 ⁻⁴ |
| I ₂ O ₃ | 377 | 1.326 x 10 ⁻⁴ |
| I ₃ O ₁ | 377 | 1.326 x 10 ⁻⁴ |
| I ₃ O ₂ | 373 | 1.340 x 10 ⁻⁴ |
| I ₃ O ₃ | 381 | 1.312 x 10 ⁻⁴ |

4.2.1 Mixing Characteristics at the Outlets of Inlet 1

Graph of Inlet 1 shows that Outlet 1 has poor mixing because of its low TSS value compared to Outlet 2 and 3, as shown in Figure 22. Outlet 3 has best effective mixing throughout the period of 90 minutes.

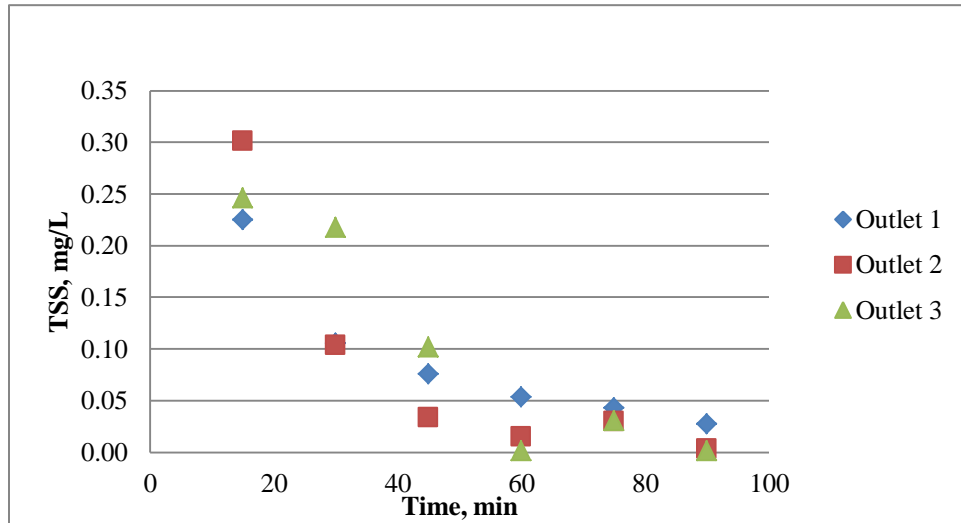

Figure 22 Graph of TSS vs Time for Inlet 1







The percentage difference for each outlet at time 15 minutes are as follows:-

$$\begin{aligned} \text{Outlet 2 and 3} &= \frac{0.3014 - 0.2462}{0.2462} \times 100 \\ &= 22.42\% \end{aligned}$$

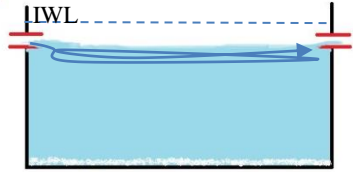
$$\begin{aligned} \text{Outlet 1 and 3} &= \frac{0.2462 - 0.2252}{0.2252} \times 100 \\ &= 9.33\% \end{aligned}$$

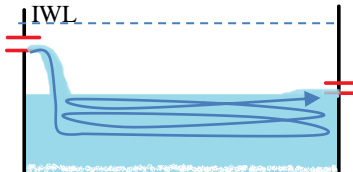
The table below shows the observation (schematic view) and the actual view (plan view) of mixing inside Inlet 1. Through observation, it was found out that the mixing occurred similarly to what the arrow is shown in the schematic view.

Table 8 Mixing Effective Region Inside Inlet 1

| Outlet | SchematicView | Plan View |
|--------|---|--|
| 1 |  |  |
| 2 |  |  |
| 3 |  |  |

4.2.2 Mixing Characteristics at the Outlets of Inlet 2

Graph of Inlet 2 shows that Outlet 2 has poor mixing because of its low TSS value compared to Outlet 1 and 3. Outlet 1 has best effective mixing throughout the period of 90 minutes.

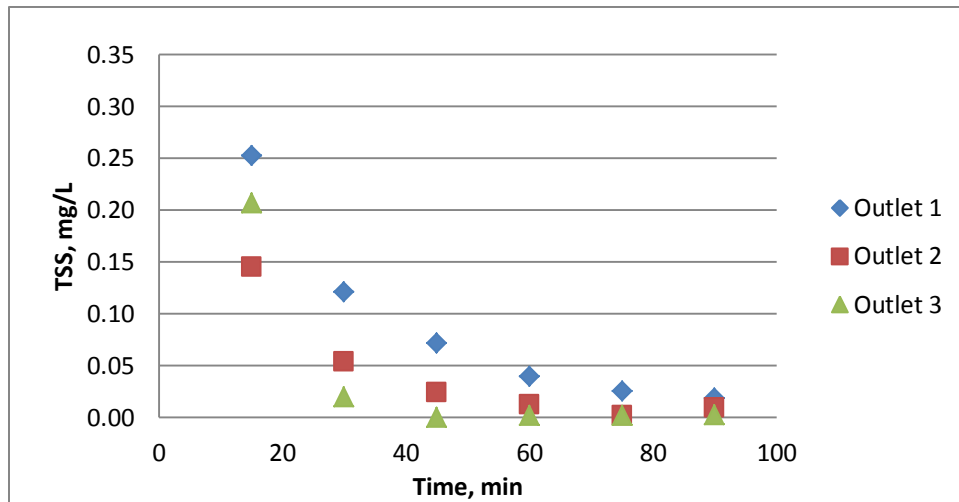

Figure 23 Graph of TSS vs Time for Inlet 2

The percentage difference for each outlet at time 15 minutes are as follows:-

$$\text{Outlet 1 and 3} = \frac{0.2526 - 0.2070}{0.2070} \times 100$$







$$= 22.03\%$$

$$\text{Outlet 2 and 3} = \frac{0.2070 - 0.1452}{0.1452} \times 100$$

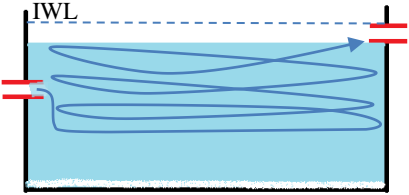
$$= 42.56\%$$

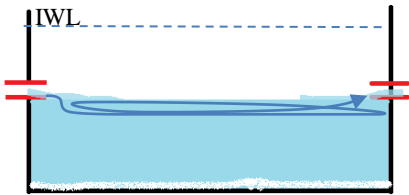
The table below shows the observation (schematic view) and the actual view (plan view) of mixing inside Inlet 2. Through observation, it was found out that the mixing occurred similarly to what the arrow is shown in the schematic view.

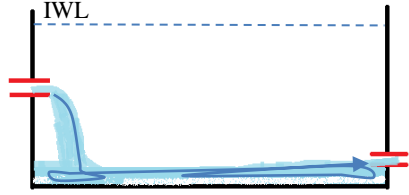
Table 9 Mixing Effective Region Inside Inlet 2

| Outlet | Side View | Plan View |
|--------|---|---|
| 1 |  |  |
| 2 |  |  |
| 3 |  |  |

4.2.3 Mixing Characteristics at the Outlets of Inlet 3

Graph of Inlet 3 shows that Outlet 3 has poor mixing because of its low TSS value compared to Outlet 1 and 2. Outlet 1 has best effective mixing throughout the period of 90 minutes.

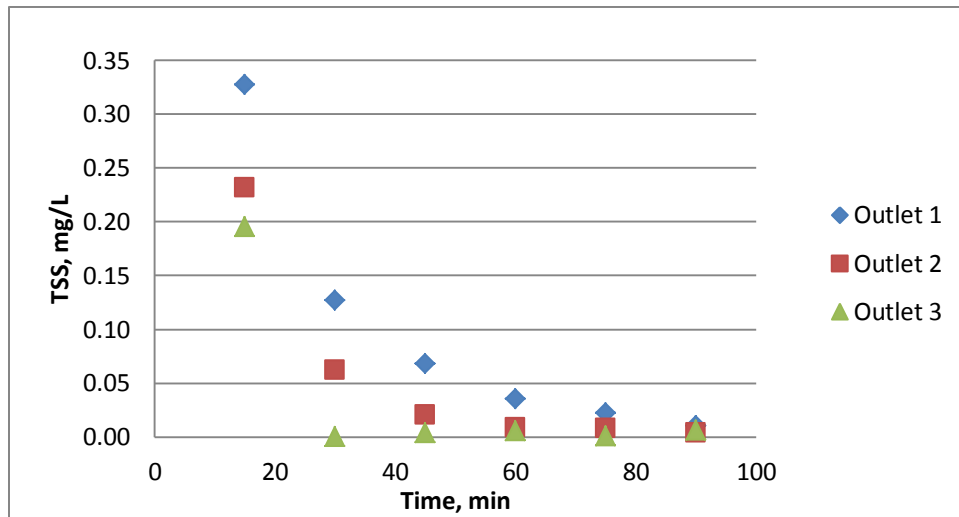

Figure 24 Graph of TSS vs Time for Inlet 3

The percentage difference for each outlet at time 15 minutes are as follows:-

$$\begin{aligned} \text{Outlet 1 and 2} &= \frac{0.3276 - 0.2318}{0.2318} \times 100 \\ &= 41.33\% \end{aligned}$$

$$\begin{aligned} \text{Outlet 2 and 3} &= \frac{0.2318 - 0.1952}{0.1952} \times 100 \\ &= 18.75\% \end{aligned}$$

CHAPTER 5: CONCLUSION AND RECOMMENDATION

5.1 Conclusion

Base on the research that has been carried out, natural mixing does happen in the circular tank under different configuration. Different choice of inflows and outflows will come out with different TSS results. Then it can be observed which configuration is the best by having highest TSS values.

The most effective mixing occurred in Inlet 3 and Outlet 1 configuration, while the least effective mixing occurred in Inlet 2 and Outlet 2 configuration. Poor mixing also happened when the configuration of the inlet and outlet are in series, for example Inlet 1 Outlet 1, Inlet 2 Outlet 2, and Inlet 3 Outlet 3.

5.2 Recommendations

Since this is a new research, there are many things that can be improved and corrected from it. One of it is to use a different shape of the tank such as square, oval or even unsymmetrical shape. Other than that is to change the position of inflows outflows configuration making it not in series such as side by side inlet outlet or top bottom inlet outlet.

This research would provide more results if the period of time taken for the experiment were longer instead of only 90 minutes. Furthermore, further research should be done by using different flowrate to check the influence of flowrate towards the inlet and outlet configuration.

REFERENCES

- [1] P. E. Michael J. Duer, Red Valve Co., Inc., "The Science of Mixing Water Storage Tanks."
- [2] (7 February 2014). *Design of Stormwater Tanks Recommendations and layouts*. Available: http://www.grundfos.com/content/dam/Global%20Site/Industries%20%26%20solutions/water-utility/pdf/Stormwater_Tanks-lowres.pdf
- [3] S. Lawson, "What is a Retention Pond?," ed.
- [4] Y. R. Jean-Michael Bergue, *Stormwater Retention Basins*: A.A. Balkema/ Rotterdam/ Brookfield, 2000.
- [5] D. o. I. a. Drainage, *Urban Stormwater Management Manual for Malaysia*, 2nd Edition ed., 2012.
- [6] S. C. M. James L. Martin, *Hydrodynamics and Transport for Water Quality Modeling*: Lewis Publishers, 1998.
- [7] J. Myers. (10 February). *What is Hydrodynamics?* Available: <http://www.wisegeek.com/what-is-hydrodynamics.htm>
- [8] (1996-2014). *Speed and Velocity*. Available: <http://www.physicsclassroom.com/class/1dkin/u1l1d.cfm>
- [9] (14 February). *Turbidity*. Available: <http://en.wikipedia.org/wiki/Turbidity>
- [10] G. H. J. Scott A. Socolofsky. (2004, 8 February 2014). *9. Mixing in Lakes and Reservoirs*. Available: http://www.ifh.uni-karlsruhe.de/lehre/envflu_II/Students/ocen689ch9.pdf
- [11] S. N. P. A. K. Tripathi, *Water Pollution*. New Delhi: A P H Publishing Corporation, 2009.

APPENDICES

Appendix 1

TSS Result for Inlet 1 and Outlet 1

| | Time (min) | Sample Size (mL) | Weight of Pan + Filter Paper Before Dry (mg) | Weight of Pan + Filter Paper After Dry (mg) | TSS (mg/L) |
|--------------------|------------|------------------|--|---|------------|
| Collection Point 1 | 15 | 500 | 1101.2 | 1524.4 | 0.8464 |
| | 30 | 500 | 1106.5 | 1309.2 | 0.4054 |
| | 45 | 500 | 1081.6 | 1133.0 | 0.1028 |
| | 60 | 500 | 1099.1 | 1148.9 | 0.0996 |
| | 75 | 500 | 1094.0 | 1138.6 | 0.0892 |
| | 90 | 500 | 1099.8 | 1138.2 | 0.0768 |
| Outlet 1 | 15 | 500 | 1333.3 | 1445.9 | 0.2252 |
| | 30 | 500 | 1107.5 | 1160.3 | 0.1056 |
| | 45 | 500 | 1102.3 | 1140.3 | 0.0760 |
| | 60 | 500 | 1107.5 | 1134.4 | 0.0538 |
| | 75 | 500 | 1109.4 | 1130.9 | 0.0430 |
| | 90 | 500 | 1101.3 | 1115.2 | 0.0278 |

Appendix 2

TSS Result for Inlet 1 and Outlet 2

| | Time (min) | Sample Size (mL) | Weight of Pan + Filter Paper Before Dry (mg) | Weight of Pan + Filter Paper After Dry (mg) | TSS (mg/L) |
|--------------------|------------|------------------|--|---|------------|
| Collection Point 1 | 15 | 500 | 1336.3 | 1595.9 | 0.5192 |
| | 30 | 500 | 1109.0 | 1170.5 | 0.1230 |
| | 45 | 500 | 1103.1 | 1125.3 | 0.0444 |
| | 60 | 500 | 1107.8 | 1121.3 | 0.0270 |
| | 75 | 500 | 1108.9 | 1122.6 | 0.0274 |
| | 90 | 500 | 1107.1 | 1113.0 | 0.0118 |
| Outlet 2 | 15 | 500 | 1101.9 | 1252.6 | 0.3014 |
| | 30 | 500 | 1109.6 | 1161.6 | 0.1040 |
| | 45 | 500 | 1084.0 | 1100.9 | 0.0338 |
| | 60 | 500 | 1101.1 | 1108.6 | 0.0150 |
| | 75 | 500 | 1092.4 | 1107.3 | 0.0298 |
| | 90 | 500 | 1102.7 | 1104.4 | 0.0034 |

Appendix 3

TSS Result for Inlet 1 and Outlet 3

| | Time (min) | Sample Size (mL) | Weight of Pan + Filter Paper Before Dry (mg) | Weight of Pan + Filter Paper After Dry (mg) | TSS (mg/L) |
|--------------------|------------|------------------|--|---|------------|
| Collection Point 1 | 15 | 500 | 1079.6 | 1263.0 | 0.3668 |
| | 30 | 500 | 1089.6 | 1199.3 | 0.2194 |
| | 45 | 500 | 1197.3 | 1257.9 | 0.1212 |
| | 60 | 500 | 1113.1 | 1116.4 | 0.0066 |
| | 75 | 500 | 1080.2 | 1087.8 | 0.0152 |
| | 90 | 500 | 1096.3 | 1100.9 | 0.0092 |
| Outlet 3 | 15 | 500 | 1086.9 | 1210.0 | 0.2462 |
| | 30 | 500 | 1085.5 | 1194.5 | 0.2180 |
| | 45 | 500 | 1088.1 | 1139.1 | 0.1020 |
| | 60 | 500 | 1092.9 | 1093.6 | 0.0014 |
| | 75 | 500 | 1118.7 | 1133.9 | 0.0304 |
| | 90 | 500 | 1084.2 | 1085.0 | 0.0016 |

Appendix 4

TSS Result for Inlet 2 and Outlet 1

| | Time (min) | Sample Size (mL) | Weight of Pan + Filter Paper Before Dry (mg) | Weight of Pan + Filter Paper After Dry (mg) | TSS (mg/L) |
|--------------------|------------|------------------|--|---|------------|
| Collection Point 1 | 15 | 500 | 1083.7 | 1463.6 | 0.7598 |
| | 30 | 500 | 1083.0 | 1363.3 | 0.5606 |
| | 45 | 500 | 1081.0 | 1129.5 | 0.0970 |
| | 60 | 500 | 1098.7 | 1142.2 | 0.0870 |
| | 75 | 500 | 1117.0 | 1156.9 | 0.0798 |
| | 90 | 500 | 1088.5 | 1117.5 | 0.0580 |
| Outlet 1 | 15 | 500 | 1082.1 | 1208.4 | 0.2526 |
| | 30 | 500 | 1113.2 | 1173.8 | 0.1212 |
| | 45 | 500 | 1195.9 | 1231.7 | 0.0716 |
| | 60 | 500 | 1111.5 | 1131.2 | 0.0394 |
| | 75 | 500 | 1079.1 | 1091.7 | 0.0252 |
| | 90 | 500 | 1093.4 | 1102.8 | 0.0188 |

Appendix 5

TSS Result for Inlet 2 and Outlet 2

| | Time (min) | Sample Size (mL) | Weight of Pan + Filter Paper Before Dry (mg) | Weight of Pan + Filter Paper After Dry (mg) | TSS (mg/L) |
|--------------------|------------|------------------|--|---|------------|
| Collection Point 1 | 15 | 500 | 1106.8 | 1447.3 | 0.6810 |
| | 30 | 500 | 1113.7 | 1415.1 | 0.6028 |
| | 45 | 500 | 1082.6 | 1137.7 | 0.1102 |
| | 60 | 500 | 1095.6 | 1110.2 | 0.0292 |
| | 75 | 500 | 1090.7 | 1106.2 | 0.0310 |
| | 90 | 500 | 1102.4 | 1130.6 | 0.0564 |
| Outlet 2 | 15 | 500 | 1335.0 | 1407.6 | 0.1452 |
| | 30 | 500 | 1108.2 | 1135.1 | 0.0538 |
| | 45 | 500 | 1104.6 | 1116.7 | 0.0242 |
| | 60 | 500 | 1106.3 | 1112.5 | 0.0124 |
| | 75 | 500 | 1110.0 | 1111.1 | 0.0022 |
| | 90 | 500 | 1103.2 | 1107.9 | 0.0094 |

Appendix 6

TSS Result for Inlet 2 and Outlet 3

| | Time (min) | Sample Size (mL) | Weight of Pan + Filter Paper Before Dry (mg) | Weight of Pan + Filter Paper After Dry (mg) | TSS (mg/L) |
|--------------------|------------|------------------|--|---|------------|
| Collection Point 1 | 15 | 500 | 1089.9 | 1222.8 | 0.2658 |
| | 30 | 500 | 1083.4 | 1093.8 | 0.0208 |
| | 45 | 500 | 1088.1 | 1090.7 | 0.0052 |
| | 60 | 500 | 1096.5 | 1097.1 | 0.0012 |
| | 75 | 500 | 1115.7 | 1120.7 | 0.0100 |
| | 90 | 500 | 1084.1 | 1084.5 | 0.0008 |
| Outlet 3 | 15 | 500 | 1092.4 | 1195.9 | 0.2070 |
| | 30 | 500 | 1114.5 | 1124.5 | 0.0200 |
| | 45 | 500 | 1196.8 | 1197.0 | 0.0004 |
| | 60 | 500 | 1116.3 | 1117.3 | 0.0020 |
| | 75 | 500 | 1083.8 | 1084.7 | 0.0018 |
| | 90 | 500 | 1104.4 | 1105.7 | 0.0026 |

Appendix 7

TSS Result for Inlet 3 and Outlet 1

| | Time (min) | Sample Size (mL) | Weight of Pan + Filter Paper Before Dry (mg) | Weight of Pan + Filter Paper After Dry (mg) | TSS (mg/L) |
|--------------------|------------|------------------|--|---|------------|
| Collection Point 1 | 15 | 500 | 1342.5 | 1565.4 | 0.4458 |
| | 30 | 500 | 1108.5 | 1177.4 | 0.1378 |
| | 45 | 500 | 1100.7 | 1138.3 | 0.0752 |
| | 60 | 500 | 1113.6 | 1131.9 | 0.0366 |
| | 75 | 500 | 1110.4 | 1121.3 | 0.0218 |
| | 90 | 500 | 1108.8 | 1114.6 | 0.0116 |
| Outlet 1 | 15 | 500 | 1104.0 | 1267.8 | 0.3276 |
| | 30 | 500 | 1113.2 | 1176.7 | 0.1270 |
| | 45 | 500 | 1091.0 | 1125.1 | 0.0682 |
| | 60 | 500 | 1104.0 | 1121.6 | 0.0352 |
| | 75 | 500 | 1086.1 | 1097.4 | 0.0226 |
| | 90 | 500 | 1101.8 | 1107.1 | 0.0106 |

Appendix 8

TSS Result for Inlet 3 and Outlet 2

| | Time (min) | Sample Size (mL) | Weight of Pan + Filter Paper Before Dry (mg) | Weight of Pan + Filter Paper After Dry (mg) | TSS (mg/L) |
|--------------------|------------|------------------|--|---|------------|
| Collection Point 1 | 15 | 500 | 1081.7 | 1198.1 | 0.2328 |
| | 30 | 500 | 1080.0 | 1116.3 | 0.0726 |
| | 45 | 500 | 1086.4 | 1105.1 | 0.0374 |
| | 60 | 500 | 1097.2 | 1100.3 | 0.0062 |
| | 75 | 500 | 1110.8 | 1116.8 | 0.0120 |
| | 90 | 500 | 1083.4 | 1084.4 | 0.0020 |
| Outlet 2 | 15 | 500 | 1086.8 | 1202.7 | 0.2318 |
| | 30 | 500 | 1115.6 | 1146.6 | 0.0620 |
| | 45 | 500 | 1203.2 | 1213.5 | 0.0206 |
| | 60 | 500 | 1108.8 | 1113.1 | 0.0086 |
| | 75 | 500 | 1080.9 | 1084.9 | 0.0080 |
| | 90 | 500 | 1097.8 | 1099.8 | 0.0040 |

Appendix 9

TSS Result for Inlet 3 and Outlet 3

| | Time (min) | Sample Size (mL) | Weight of Pan + Filter Paper Before Dry (mg) | Weight of Pan + Filter Paper After Dry (mg) | TSS (mg/L) |
|--------------------|------------|------------------|--|---|------------|
| Collection Point 1 | 15 | 500 | 1097.1 | 1197.7 | 0.2012 |
| | 30 | 500 | 1113.1 | 1116.2 | 0.0062 |
| | 45 | 500 | 1089.3 | 1089.8 | 0.0010 |
| | 60 | 500 | 1098.8 | 1098.9 | 0.0002 |
| | 75 | 500 | 1097.0 | 1097.5 | 0.0010 |
| | 90 | 500 | 1111.7 | 1112.7 | 0.0020 |
| Outlet 3 | 15 | 500 | 1337.5 | 1435.1 | 0.1952 |
| | 30 | 500 | 1111.7 | 1112.0 | 0.0006 |
| | 45 | 500 | 1102.3 | 1104.3 | 0.0040 |
| | 60 | 500 | 1114.5 | 1117.3 | 0.0056 |
| | 75 | 500 | 1115.0 | 1115.4 | 0.0008 |
| | 90 | 500 | 1106.8 | 1110.0 | 0.0064 |