

SYSTEM IDENTIFICATION FOR SISO SYSTEMS

KIRUTIGAA A/P RANGASAMY

CHEMICAL ENGINEERING
UNIVERSITI TEKNOLOGI PETRONAS
MAY 2014

KIRUTIGAA A/P RANGASAMY B. ENG. (HONS) CHEMICAL ENGINEERING MAY 2014

System Identification for SISO Systems

by

Kirutigaa Rangasamy

Dissertation submitted in partial fulfilment of
the requirements for the Bachelor of Engineering (Hons)
(Chemical Engineering)

MAY 2014

Universiti Teknologi PETRONAS
Bandar Seri Iskandar
31750 Tronoh
Perak Darul Ridzuan

CERTIFICATION OF APPROVAL

System Identification for SISO Systems

by

Kirutigaa A/P Rangasamy

A project dissertation submitted to the
Chemical Engineering Programme
Universiti Teknologi PETRONAS
in partial fulfilment of the requirement for the
BACHELOR OF ENGINEERING (Hons)
(CHEMICAL ENGINEERING)

Approved by,

(ASSOC PROF DR RAMASAMY MARAPPA GOUNDER)

UNIVERSITI TEKNOLOGI PETRONAS

TRONOH, PERAK

May 2014

CERTIFICATION OF ORIGINALITY

This is to certify that I am responsible for the work submitted in this project, that the original work is my own except as specified in the references and acknowledgements, and that the original work contained herein have not been undertaken or done by unspecified sources or persons.

KIRUTIGAA A/P RANGASAMY

ABSTRACT

System identification is a well-established field, grew both in size and diversity over the last several decades. In addition, system identification methods can handle an extensive range of system dynamics without knowledge of the actual system physics. In this report, system identification for single-input and single-output (SISO) system and the improvisation techniques are discussed. The most significant criteria in system identification are selection of suitable model structure, excitation signal, signal to noise ratio (SNR) and frequency. This can be done by using System Identification Toolbox in MATLAB, where it will build an accurate and simplified model from complex system with noisy time-series data. Three different systems are discussed by using ARX, ARMAX and OE models. For each system, five case studies with different orders are discussed. In addition, different types of excitation signals are used in order to get the best results. The model fitting, bode plot, step response and residual plot are obtained by using System Identification Toolbox. Besides that, the mathematical equations which are used to calculate the parameters are also presented in the following section. Based on the fitting, the best models are interpreted. The results of each case study show the importance of model selection for different scenarios.

ACKNOWLEDGEMENT

First and foremost, the author would like to express her highest gratitude to her supervisor, Assoc Prof Dr Ramasamy Marappa Gounder for all the motivation, knowledge and valuable advices that he has given. The guidance and supervision from him have granted her many opportunities to explore, learn and experience throughout the project.

The author is also very grateful to Mr. Abdelraheem Faisal Mohammed who had provided the author constructive advices and valuable assistances in accomplishing the project. This project will not be successful without the technical helps from him.

Finally, the author would like to extend her appreciation to Universiti Teknologi PETRONAS for providing the facilities and many learning opportunities, and special thanks to her family and friends who constantly support her throughout the project. Thank you.

Table of Contents

ABSTRACT	v
ACKNOWLEDGEMENT	vi
CHAPTER 1	1
INTRODUCTION	1
1.1 Background	1
1.2 Problem Statement	2
1.3 Objectives, Scope of Study, Relevancy and Feasibility of the Project	2
1.3.1 Objectives.....	2
1.3.2 Scope of Study	3
1.3.3 Relevancy of the Project	3
1.3.4 Feasibility of the Project	3
CHAPTER 2	4
LITERATURE REVIEW AND / OR THEORY	4
CHAPTER 3	11
METHODOLOGY / PROJECT WORK	11
3.1 Research Methodology and Project Activities	11
3.2 Key Milestone	12
3.2.1 Key Milestone for FYP I.....	12
3.2.2 Key Milestone for FYP II	13
3.3 Gantt Chart	14
3.3.1 FYP I.....	14
3.3.2 FYP II.....	15
CHAPTER 4	16
RESULT & DISCUSSION	16
4.1 Model Structures	16

4.2 Simulation in MATLAB Environment	22
CHAPTER 5	108
CONCLUSION & RECOMMENDATION	108
5.1 Conclusion	108
5.2 Recommendations	108
REFERENCES.....	109

LIST OF FIGURES

Figure 1: Input-output process model	1
Figure 2: General linear model	5
Figure 3: AR model structure.....	6
Figure 4: MA model structure.....	6
Figure 5: ARMA model structure	6
Figure 6: ARX model structure.....	7
Figure 7: ARMAX model structure	7
Figure 8: ARARX model structure	7
Figure 9: Input, u & Output, y vs. Time	23
Figure 10: Comparison of model output with the actual measured values (Second Order)	24
Figure 11: Step response for OE, ARX and ARMAX models (Second Order).....	24
Figure 12: Bode Plot for OE, ARX and ARMAX models (Second Order).....	25
Figure 13: Residual Plot for OE (Second Order)	25
Figure 14: Residual Plot for ARMAX (Second Order)	26
Figure 15: Residual Plot for ARX (Second Order).....	26
Figure 16: Comparison of model output with the actual measured values (Third Order)	27
Figure 17: Step response for OE, ARX and ARMAX models (Third Order).....	27
Figure 18: Bode Plot for OE, ARX and ARMAX models (Third Order).....	28
Figure 19: Residual Plot for OE (Third Order).....	28
Figure 20: Residual Plot for ARMAX (Third Order)	29
Figure 21: Residual Plot for ARX (Third Order).....	29
Figure 22: Comparison of model output with the actual measured values (Fourth Order)	30
Figure 23: Step response for OE, ARX and ARMAX models (Fourth Order).....	30
Figure 24: Bode Plot for OE, ARX and ARMAX models (Fourth Order).....	31
Figure 25: Residual Plot for OE (Fourth Order)	31
Figure 26: Residual Plot for ARMAX (Fourth Order).....	32
Figure 27: Residual Plot for ARX (Fourth Order)	32

Figure 28: Comparison of model output with the actual measured values (Fifth Order)	33
Figure 29: Step response for OE, ARX and ARMAX models (Fifth Order).....	33
Figure 30: Bode Plot for OE, ARX and ARMAX models (Fifth Order).....	34
Figure 31: Residual Plot for OE (Fifth Order).....	34
Figure 32: Residual Plot for ARMAX (Fifth Order)	35
Figure 33: Residual Plot for ARX (Fifth Order).....	35
Figure 34: Comparison of model output with the actual measured values (Sixth Order)	36
Figure 35: Step response for OE, ARX and ARMAX models (Sixth Order).....	36
Figure 36: Bode Plot for OE, ARX and ARMAX models (Sixth Order)	37
Figure 37: Residual Plot for OE (Sixth Order)	37
Figure 38: Residual Plot for ARMAX (Sixth Order).....	38
Figure 39: Residual Plot for ARX (Sixth Order)	38
Figure 40: Input,u & Output,y vs. Time (PRBS).....	41
Figure 41: Input, u & Output, y vs. Time (APRBS).....	41
Figure 42: Comparison of model output with the actual measured values (First Order-PRBS).....	43
Figure 43: Step response for OE, ARX and ARMAX models (First Order-PRBS).....	43
Figure 44: Bode Plot for OE, ARX and ARMAX models (First Order-PRBS)	44
Figure 45: Residual Plot for OE (First Order-PRBS)	44
Figure 46: Residual Plot for ARMAX (First Order-PRBS).....	45
Figure 47: Residual Plot for ARX (First Order-PRBS)	45
Figure 48: Comparison of model output with the actual measured values (Second Order-PRBS).....	46
Figure 49: Step response for OE, ARX and ARMAX models (Second Order-PRBS) ...	46
Figure 50: Bode Plot for OE, ARX and ARMAX models (Second Order-PRBS).....	47
Figure 51: Residual Plot for OE (Second Order-PRBS).....	47
Figure 52: Residual Plot for ARMAX (Second Order-PRBS)	48
Figure 53: Residual Plot for ARX (Second Order-PRBS).....	48
Figure 54: Comparison of model output with the actual measured values (Third Order-PRBS).....	49
Figure 55: Step response for OE, ARX and ARMAX models (Third Order-PRBS)	49

Figure 56: Bode Plot for OE, ARX and ARMAX models (Third Order-PRBS).....50

Figure 57: Residual Plot for OE (Third Order-PRBS).....50

Figure 58: Residual Plot for ARMAX (Third Order-PRBS)51

Figure 59: Residual Plot for ARMAX (Third Order-PRBS)51

Figure 60: Comparison of model output with the actual measured values (Fourth Order-PRBS).....52

Figure 61: Step response for OE, ARX and ARMAX models (Fourth Order-PRBS).....52

Figure 62: Bode Plot for OE, ARX and ARMAX models (Fourth Order-PRBS).....53

Figure 63: Residual Plot for OE (Fourth Order-PRBS)53

Figure 64: Residual Plot for ARMAX (Fourth Order-PRBS)54

Figure 65: Residual Plot for ARX (Fourth Order-PRBS).....54

Figure 66: Comparison of model output with the actual measured values (Fourth Order-PRBS).....55

Figure 67: Step response for OE, ARX and ARMAX models (Fifth Order-PRBS)55

Figure 68: Bode Plot for OE, ARX and ARMAX models (Fifth Order-PRBS).....56

Figure 69: Residual Plot for OE (Fifth Order-PRBS).....56

Figure 70: Residual Plot for ARMAX (Fifth Order-PRBS)57

Figure 71: Residual Plot for ARX (Fifth Order-PRBS).....57

Figure 72: Comparison of model output with the actual measured values (First Order-APRBS).....58

Figure 73: Step response for OE, ARX and ARMAX models (First Order-APRBS)58

Figure 74: Bode Plot for OE, ARX and ARMAX models (First Order-APRBS)59

Figure 75: Residual Plot for OE (First Order-APRBS)59

Figure 76: Residual Plot for ARMAX (First Order-APRBS).....60

Figure 77: Residual Plot for ARX (First Order-APRBS)60

Figure 78: Comparison of model output with the actual measured values (Second Order-APRBS).....61

Figure 79: Step response for OE, ARX and ARMAX models (Second Order-APRBS).61

Figure 80: Bode Plot for OE, ARX and ARMAX models (Second Order-APRBS).....62

Figure 81: Residual Plot for OE (Second Order-APRBS)62

Figure 82: Residual Plot for ARMAX (Second Order-APRBS)63

Figure 83: Residual Plot for ARX (Second Order-APRBS).....	63
Figure 84: Comparison of model output with the actual measured values (Third Order-APRBS).....	64
Figure 85: Step response for OE, ARX and ARMAX models (Third Order-APRBS)....	64
Figure 86: Bode Plot for OE, ARX and ARMAX models (Third Order-APRBS).....	65
Figure 87: Residual Plot for OE (Third Order-APRBS).....	65
Figure 88: Residual Plot for ARMAX (Third Order-APRBS)	66
Figure 89: Residual Plot for OE (Third Order-APRBS).....	66
Figure 90: Comparison of model output with the actual measured values (Fourth Order-APRBS).....	67
Figure 91: Step response for OE, ARX and ARMAX models (Fourth Order-APRBS)..	67
Figure 92: Bode Plot for OE, ARX and ARMAX models (Fourth Order-APRBS).....	68
Figure 93: Residual Plot for OE (Fourth Order-APRBS)	68
Figure 94: Residual Plot for ARMAX (Fourth Order-APRBS).....	69
Figure 95: Residual Plot for ARX (Fourth Order-APRBS).....	69
Figure 96: Comparison of model output with the actual measured values (Fifth Order-APRBS).....	70
Figure 97: Step response for OE, ARX and ARMAX models (Fifth Order-APRBS).....	70
Figure 98: Bode Plot for OE, ARX and ARMAX models (Fifth Order-APRBS).....	71
Figure 99: Residual Plot for OE (Fifth Order-APRBS)	71
Figure 100: Residual Plot for ARMAX (Fifth Order-APRBS)	72
Figure 101: Residual Plot for OE (Fifth Order-APRBS)	72
Figure 102: Input,u & Output,y vs. Time (PRBS)	75
Figure 103: Input,u & Output,y vs. Time (PRBS)	75
Figure 104: Comparison of model output with the actual measured values (First Order-PRBS).....	77
Figure 105: Step response for OE, ARX and ARMAX models (First Order-PRBS).....	77
Figure 106: Bode Plot for OE, ARX and ARMAX models (First Order-PRBS)	78
Figure 107: Residual Plot for OE (First Order-PRBS)	78
Figure 108: Residual Plot for ARMAX (First Order-PRBS).....	79
Figure 109: Residual Plot for ARX (First Order-PRBS)	79

Figure 110: Comparison of model output with the actual measured values (Second Order-PRBS).....	80
Figure 111: Step response for OE, ARX and ARMAX models (Second Order-PRBS)..	80
Figure 112: Bode Plot for OE, ARX and ARMAX models (Second Order-PRBS).....	81
Figure 113: Residual Plot for OE (Second Order-PRBS).....	81
Figure 114: Residual Plot for ARMAX (Second Order-PRBS)	82
Figure 115: Residual Plot for ARX (Second Order-PRBS).....	82
Figure 116: Comparison of model output with the actual measured values (Third Order-PRBS).....	83
Figure 117: Step response for OE, ARX and ARMAX models (Third Order-PRBS)	83
Figure 118: Bode Plot for OE, ARX and ARMAX models (Third Order-PRBS).....	84
Figure 119: Residual Plot for OE (Third Order-PRBS).....	84
Figure 120: Residual Plot for ARMAX (Third Order-PRBS)	85
Figure 121: Residual Plot for ARX (Third Order-PRBS).....	85
Figure 122: Comparison of model output with the actual measured values (Fourth Order-PRBS).....	86
Figure 123: Step response for OE, ARX and ARMAX models (Fourth Order-PRBS)...	86
Figure 124: Bode Plot for OE, ARX and ARMAX models (Fourth Order-PRBS).....	87
Figure 125: Residual Plot for OE (Fourth Order-PRBS).....	87
Figure 126: Residual Plot for ARMAX (Fourth Order-PRBS)	88
Figure 127: Residual Plot for ARX (Fourth Order-PRBS).....	88
Figure 128: Comparison of model output with the actual measured values (Fifth Order-PRBS).....	89
Figure 129: Step response for OE, ARX and ARMAX models (Fourth Order-PRBS)...	89
Figure 130: Bode Plot for OE, ARX and ARMAX models (Fifth Order-PRBS).....	90
Figure 131: Residual Plot for OE (Fifth Order-PRBS).....	90
Figure 132: Residual Plot for ARMAX (Fifth Order-PRBS)	91
Figure 133: Residual Plot for OE (Fifth Order-PRBS).....	91
Figure 134: Comparison of model output with the actual measured values (First Order-APRBS).....	92
Figure 135: Step response for OE, ARX and ARMAX models (First Order-APRBS) ...	92

Figure 136: Bode Plot for OE, ARX and ARMAX models (First Order-APRBS)	93
Figure 137: Residual Plot for OE (First Order-APRBS)	93
Figure 138: Residual Plot for ARMAX (First Order-APRBS).....	94
Figure 139: Residual Plot for ARX (First Order-APRBS)	94
Figure 140: Comparison of model output with the actual measured values (Second Order-APRBS)	95
Figure 141: Step response for OE, ARX and ARMAX models (Second Order-APRBS)	95
Figure 142: Bode Plot for OE, ARX and ARMAX models (Second Order-APRBS).....	96
Figure 143: Residual Plot for OE (Second Order-APRBS).....	96
Figure 144: Residual Plot for ARMAX (Second Order-APRBS)	97
Figure 145: Residual Plot for ARX (Second Order-APRBS).....	97
Figure 146: Comparison of model output with the actual measured values (Third Order-APRBS).....	98
Figure 147: Step response for OE, ARX and ARMAX models (Third Order-APRBS)..	98
Figure 148: Bode Plot for OE, ARX and ARMAX models (Third Order-APRBS).....	99
Figure 149: Residual Plot for OE (Third Order-APRBS).....	99
Figure 150: Residual Plot for ARMAX (Third Order-APRBS)	100
Figure 151: Residual Plot for ARX (Third Order-APRBS).....	100
Figure 152: Comparison of model output with the actual measured values (Fourth Order-APRBS).....	101
Figure 153: Step response for OE, ARX and ARMAX models (Fourth Order-APRBS)	101
Figure 154: Bode Plot for OE, ARX and ARMAX models (Fourth Order-APRBS)....	102
Figure 155: Residual Plot for OE (Fourth Order-APRBS)	102
Figure 156: Residual Plot for ARMAX (Fourth Order-APRBS).....	103
Figure 157: Residual Plot for ARX (Fourth Order-APRBS)	103
Figure 158: Comparison of model output with the actual measured values (Fifth Order-APRBS).....	104
Figure 159: Step response for OE, ARX and ARMAX models (Fifth Order-APRBS).	104
Figure 160: Bode Plot for OE, ARX and ARMAX models (Fifth Order-APRBS).....	105

Figure 161: Residual Plot for OE (Fifth Order-APRBS) 105

Figure 162: Residual Plot for ARMAX (Fifth Order-APRBS) 106

Figure 163: Residual Plot for ARX (Fifth Order-APRBS)..... 106

LIST OF TABLES

Table 1: Class of output error models 8

Table 2: Comparison of input signals 9

GLOSSARY

APRBS: Amplitude Modulated Pseudo Random Binary Signal

PRBS: Pseudo Random Binary Signal

AR: Autoregressive

ARMA: Autoregressive Moving Average

ARX: Autoregressive with Exogenous Input

ARMAX: Autoregressive Moving Average with Exogenous Input

ARARX: Autoregressive Autoregressive with Exogenous Input

OE: Output Error

BJ: Box Jenkins

FIR: Finite Impulse Response

SISO: Single-Input Single-Output

MIMO: Multiple-Input Multiple-Output

LSE: Least Square Estimates

LTI: Linear Time Invariant

CONTSID: Continuous Time System Identification

CHAPTER 1

INTRODUCTION

1.1 Background

Over the years, several modelling approaches have been used in process industries for control applications. There are two process models, which are, theoretical and empirical. Since theoretical models may not be practical for multifarious processes, empirical model was developed (Seborg, 2011). In system identification, the system model will be unknown which can be only identified through its input-output data. Figure 1.1 explains about input-output process model. “Black box” term is used to describe this method because the process being modelled can be related to an opaque box (Eskinat et al., 1993). System identification allows building mathematical models of a dynamic system based on measured data and alters the parameters until the output corresponds with the measured data (Ljung, 2005).

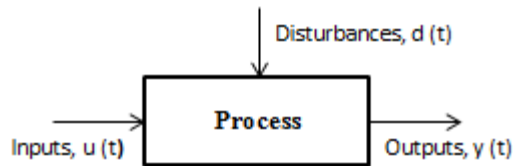

Figure 1: Input-output process model

Model structure is the most significant step in system identification. The evaluation of model quality is normally based on how well the models perform when they reproduce the measured data. Many approaches were discussed in process identification by using parametric and non-parametric models. According to Ying & Joseph (1999), the main problem faced by a control engineer is selection of model structure. As we can see in the later sections of this report, parametric models and linear dynamic system identification methods will be focused. True process behaviour with a finite number of parameters can be described by using parametric models (Nelles, 2001).

When theoretical models are very complicated, empirical process model provides a feasible solution. There are a variety of model structures available to assist in modelling. The selection of model structure is based on the understanding of the system identification method. Both system and disturbance dynamics play an important role in the proper model selection.

In addition, system identification is quite a mature field of study that has an interesting and productive development. Even though several studies have been reported on SISO systems, there are problems still remaining to be solved. This project aims to understand the drawbacks of the existing identification techniques and to propose improved identification techniques. SISO system refers to a simple single variable control system with one input and one output.

1.2 Problem Statement

System identification is about constructing and validating models from measured data. There are many aspects that need to be considered when designing system identification experiments in control applications. As explained in the background section of this report, selection of model structure is very important. It is referred to as structure estimation where the model input-output signals and the internal components of the models are determined. Systems can be analysed and its behaviour can be predicted with accurate models. Besides that, parametric estimation also plays a major role in system identification. For this project, least squares estimates (LSE) or iterative techniques will be focused.

1.3 Objectives, Scope of Study, Relevancy and Feasibility of the Project

1.3.1 Objectives

The objectives of this project are:

- To review and understand the system identification techniques for SISO systems
- To develop an improvised system identification technique for SISO systems

1.3.2 Scope of Study

System identification for linear SISO continuous-time systems will be considered. The existing identification techniques in System Identification Toolbox in MATLAB will be used extensively for the review and understanding.

1.3.3 Relevancy of the Project

This project is important as it deals with current issue in process industries for control applications. An improvement technique is considered to obtain a control relevant model, while minimizing the models mismatch, in other words, getting good fit. Good fit (minimal model mismatch) will have higher order model. However, increasing the order is not appropriate for control, especially for model-based controllers. Thus, an improvement in this issue is to be accomplished through the study of different models, then modifying their structures or combining models together.

1.3.4 Feasibility of the Project

- Scope of study - This project is feasible because it encompasses the knowledge of System Identification. In addition, System Identification Toolbox in MATLAB will be used to give a better understanding on this project.
- Time allocation (2 semesters) - The time frame is sufficient for a complete study on the literatures available on this topic as well as to develop different models and determine its fitting.

CHAPTER 2

LITERATURE REVIEW AND / OR THEORY

System identification is concerned with the determination of particular models for systems that are intended for a certain purpose such as control (Sinha & Rao, 1991). Modelling and identification techniques can help to improve the knowledge about a system. The choice of a suitable model structure is a necessity before its estimation. There are three types of models which are common in system identification; black box model, grey-box model and theoretical model (Ljung et al., 2006).

For black-box model, the systems and all model parameters are assumed to be unknown and adjustable without considering the physical background. The parameters cannot be adjusted randomly. Where else, some of the physical parameters are assumed to be known and the model parameters might have some limitations in the grey-box model. For theoretical model, both the system and parameters of the model are completely known.

The selection of discrete-time models over continuous time models is becoming ordinary, especially for advanced control strategies (Seborg, 2011). Continuous-time-model-based system identification techniques were initiated in the middle of the last century, but were overshadowed by the devastating developments in discrete-time methods for some time. Currently, the field of identification has matured and several of the methods are integrated in the continuous time system identification (CONTSID) toolbox for use with MATLAB (Rao & Unbehauen, 2006). The CONTSID toolbox contains time-domain identification methods of continuous parametric models for linear time-invariant (LTI) SISO and MIMO system in open loop (Garnier & Mensler, 1999).

Parametric models which is known as black-box model, define systems in terms of differential equations and transfer functions. These models provide insight into the system physics and compact model structures. It is normally good to test a number of structures in order to determine the best one. A system can be described by using equation 2.1, which is known as general-linear polynomial model or the general linear

model. The filter $G(q)$ is called the input transfer function, since it relates the input $u(k)$ to the output $y(k)$, and the filter $H(q)$ is called the noise transfer function since it relates the noise $v(k)$ to the output $y(k)$ (Nelles, 2001).

$$y(k) = G(q) u(k) + H(q) v(k) \quad [2.1]$$

or equivalently as

$$y(k) = \frac{B(q)}{F(q)A(q)} u(k) + \frac{C(q)}{D(q)A(q)} v(k)$$

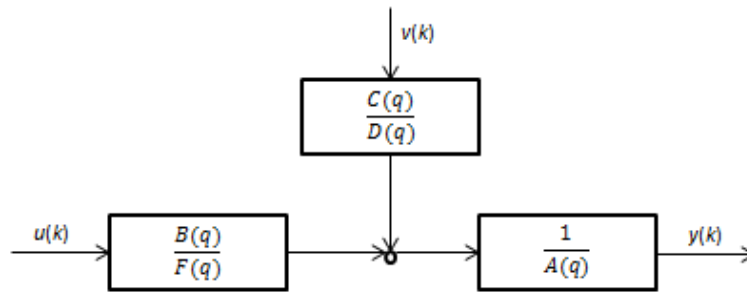

Figure 2: General linear model

Simpler models such as autoregressive (AR), moving average (MA), autoregressive moving average (ARMA), autoregressive with exogenous input (ARX), autoregressive moving average with exogenous input (ARMAX), autoregressive autoregressive with exogenous input (ARARX), Box-Jenkins (BJ), Output-Error (OE) and finite impulse response (FIR) structures can be produced from the general linear model structure by setting one or more of $A(q)$, $B(q)$, $C(q)$, $D(q)$ or $F(q)$ polynomials. Each of these methods has their own advantages and disadvantages and is commonly used in real-world applications. The selectivity of a model structure depends on the dynamics and noise characteristics of the system.

The AR model structure is a process model used in the generation of models where outputs are only dependent on previous outputs and no system inputs or disturbances are used. This is a very simple model which is limited in problem solving. Time series analyses, such as linear prediction coding commonly use the AR model.

$$y(k) = \frac{1}{D(q)} v(k) \quad [2.2]$$

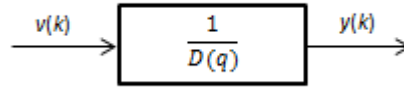

Figure 3: AR model structure

Moving average model is a time series model with a numerator polynomial only. It is used to describe stationary time series by passing white noise through filter.

$$y(k) = C(q) v(k) \quad [2.3]$$

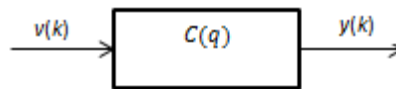

Figure 4: MA model structure

ARMA model is the combination of AR and MA models. It is a time series model with a numerator and denominator polynomial. ARMA method is useful for low order polynomials (less than 3).

$$y(k) = \frac{C(q)}{D(q)} v(k) \quad [2.4]$$

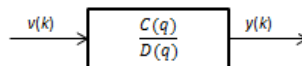

Figure 5: ARMA model structure

Models that are solely based on time series cannot be very accurate. In order to solve this problem, more accurate models are constructed by including one or more input variables into the model (Nelles, 2001). The input $u(k)$ is called an exogenous input. There are two classes of models, which are, equation error models and output error models. ARX, ARMAX and ARARX models belong to the class of equation error models where else, OE, BJ and FIR belong to the class of output error models.

ARX model estimation is the most efficient of the polynomial estimation methods because it is the result of solving linear regression equations in analytic form. In addition, ARX model is preferable when the model order is high. The disadvantage of ARX model is, transfer function in deterministic part and stochastic part of the system have the same set of poles. This problem can be overwhelmed if the signal-to-noise ratio is good.

$$y(k) = \frac{B(q)}{A(q)}u(k) + \frac{1}{A(q)}v(k) \quad [2.5]$$

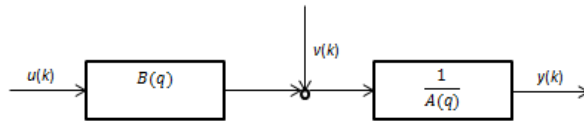

Figure 6: ARX model structure

ARMAX model structure includes disturbance dynamics. It will be useful when there is dominating disturbances that enter at the input.

$$y(k) = \frac{B(q)}{A(q)}u(k) + \frac{C(q)}{A(q)}v(k) \quad [2.6]$$

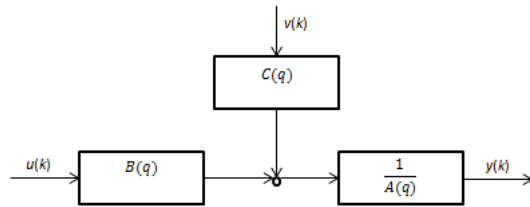

Figure 7: ARMAX model structure

ARARX model is an extended AR model. It is similar to an ARX model, but there is an additional flexibility in the denominator of the noise transfer function.

$$y(k) = \frac{B(q)}{A(q)}u(k) + \frac{1}{A(q)D(q)}v(k) \quad [2.7]$$

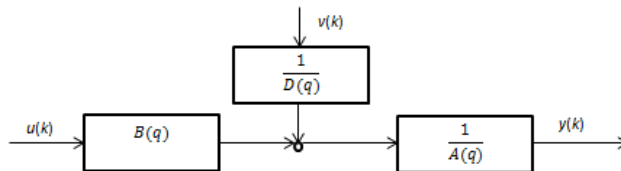
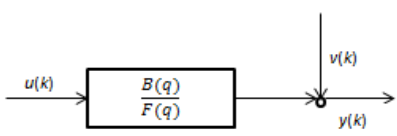
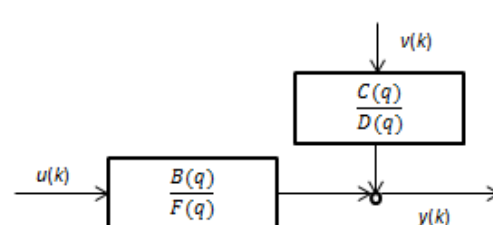
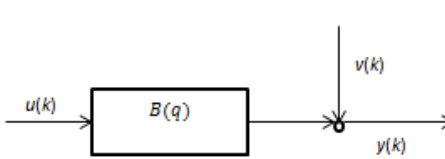

Figure 8: ARARX model structure

The Output-Error (OE) model is different from the ARX model because white noise enters without any filter (Nelles, 2001). OE model can be enhanced by filtering the white noise through ARMA filter. This defines the Box-Jenkins (BJ) model. FIR model is an OE or ARX model without any feedback, which means, $F(q)$ or $A(q)$ equals to 1.

Table 1 explains class of output error models:

Table 1: Class of output error models

Model	Model Structure	Model Equation
OE		$y(k) = \frac{B(q)}{F(q)} u(k) + v(k)$
BJ		$y(k) = \frac{B(q)}{F(q)} u(k) + \frac{C(q)}{D(q)} v(k)$
FIR		$y(k) = B(q) u(k) + v(k)$

A process can be excited by using input signals such as constant, impulse, step, rectangular and pseudo random binary signal (PRBS). Table 2 shows the comparison of the input signals.

Table 2: Comparison of input signals

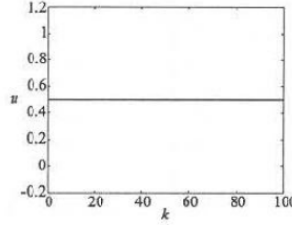
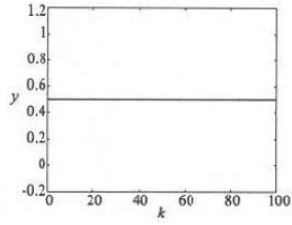
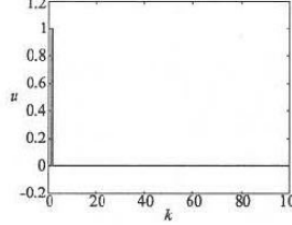
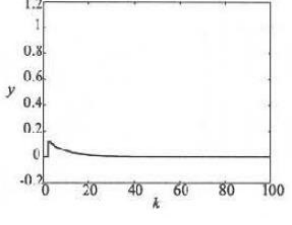
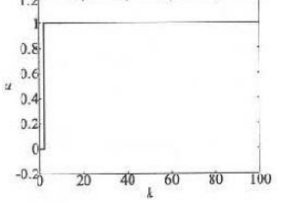
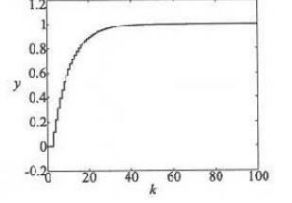
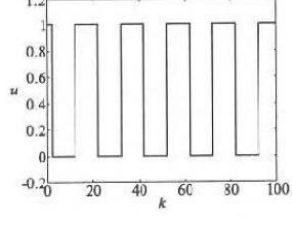
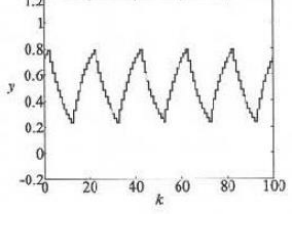
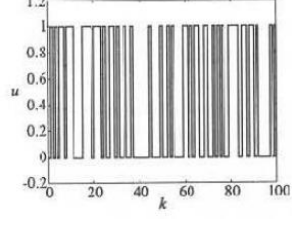
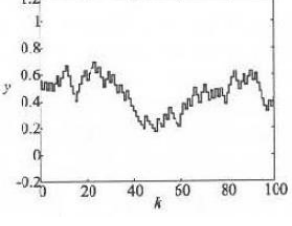
Input Signal	Description	Example of Excitation with the Input Signal	Example of Undisturbed Process Output
Constant	<ul style="list-style-type: none"> • Not suitable for identification except for one parameter because no dynamics are excited 		
Impulse	<ul style="list-style-type: none"> • Since gain is estimated inaccurately, impulse signal is not suitable for identification 		
Step	<ul style="list-style-type: none"> • Well suited for identification • Static gain is estimated accurately 		
Rectangular	<ul style="list-style-type: none"> • Well suited for identification • Time constant will be estimated accurately 		
PRBS	<ul style="list-style-type: none"> • Well suited for identification • Replicates white noise in discrete time with deterministic signal • Excites all frequencies equally 		

The model selection is very important for input signal design. The input signal must excite at low frequencies, if the emphasis is on static behaviour. If the model is required to run at particular frequencies, an additive mixture of sine waves is the best selection for input signal. A white input signal will be the best selection when there is a very little information provided on the intended use of the model and characteristics of the process. The reason is, white input signal excites all frequencies equally. High frequencies do not play an important role when the sampling time is very small. According to (Nelles, 2001), it is sensible to select the sampling time at about $1/20$ to $1/10$ of the settling time of the process.

CHAPTER 3

METHODOLOGY / PROJECT WORK

3.1 Research Methodology and Project Activities

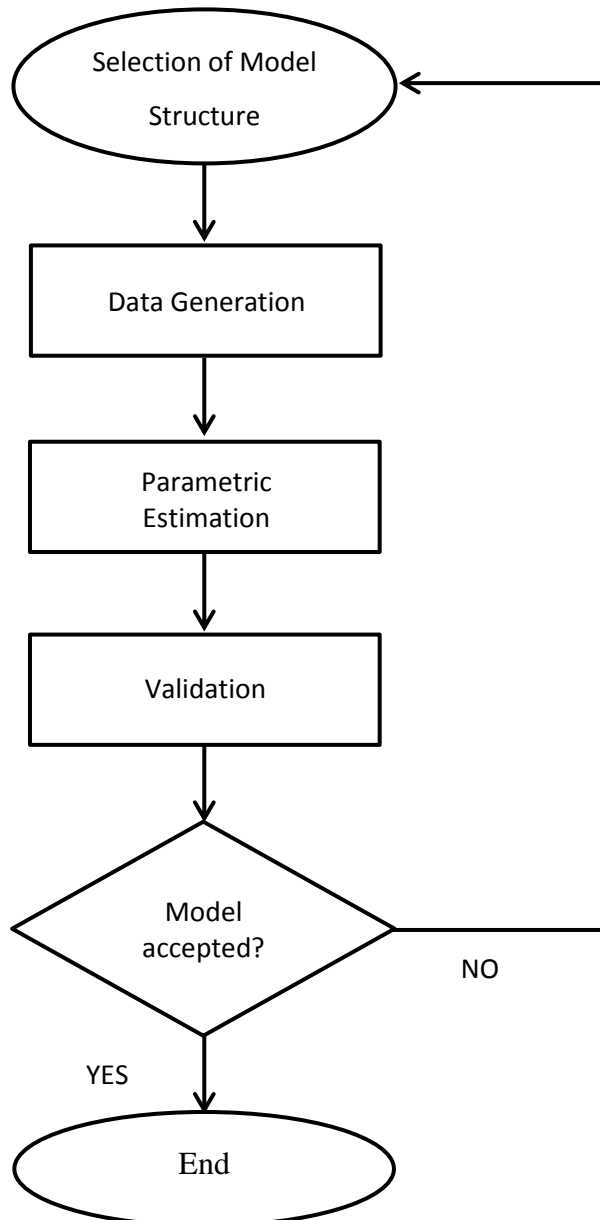

System Identification Toolbox in MATLAB will be used for building accurate and simplified models from complex systems with noisy time-series data. In addition, it has some techniques to adjust parameters in linear models and do pre-processing to examine the model's properties and alter the measured data.

For step 1, model selection, the System Identification Toolbox offers black-box input-output, state-space structures, general tailor-made linear state-space models in discrete and continuous time, as well as a variety of nonparametric models. Select a suitable model from the options. Pre-processing data should be done after acquiring the data. Pre-processing involves steps such as detrending, selecting data ranges, prefiltering and resampling.

Selection of type of input is required in step 2. The input signal is the user's only degree of freedom to determine the signal-to-noise ratio. There are five types of input signals which are constant, impulse, step, rectangular and pseudo random binary signal (PRBS). Constant and impulse signals are not well suited for identification, where else, step, rectangular and PRBS signals are well suited for identification.

Parametric estimation will be done by using least squares estimate (LSE) or iterative techniques. The method of least squares is about estimating parameters by minimizing the squared discrepancies between observed data and real values.

Finally, validation data is used for model validation purposes according to ISC in order to choose best model. Here, the model's output will be compared to the measured one on a data set that wasn't used for the fit.

3.2 Key Milestone

Several key milestones for this research project must be achieved in order to meet the objectives of the Final Year Project I (FYP I) and Final Year Project II (FYP II) :-

3.2.1 Key Milestone for FYP I

- Selection and confirmation of project title
- Completion and submission of Extended Proposal
- Oral presentation of Proposal Defence
- Submission of draft and final Interim Report

3.2.2 Key Milestone for FYP II

- Completion and submission of progress report
- Pre-SEDEX preparation and oral presentation
- Completion and submission of final draft report (soft bound)
- Completion and submission of technical paper
- Oral presentation (VIVA)
- Completion and submission of project dissertation (hard bound)

3.3 Gantt Chart

3.3.1 FYPI

NO	DETAIL	WEEK														
		1	2	3	4	5	6	7	8	9	10	11	12	13	14	
1	Selection of Project Title	■	■													
2	Preliminary Research Work and Literature Review		■	■	■	■	■									
3	Submission of Extended Proposal							●								
4	Preparation for Oral Proposal Defence							■								
5	Oral Proposal Defence Presentation								■	■						
6	Project Work								■	■	■	■	■			
7	Preparation of Interim Report											■	■	■		
8	Submission of Interim Draft Report														●	
9	Submission of Interim Final Report															●

3.3.2 FYP II

NO	DETAIL	WEEK															
		1	2	3	4	5	6	7	8	9	10	11	12	13	14	15	
1	Continuation of Project Work																
2	Submission of Progress Report																
3	Continuation of Project Work																
4	Pre-SEDEX Presentation																
5	Submission of Draft Report																
6	Submission of Dissertation (soft bound)																
7	Submission of Technical Paper																
8	Oral Presentation																
9	Submission of Project Dissertation (hard bound)																

CHAPTER 4

RESULT & DISCUSSION

For this project, three models are used, ARX, ARMAX and OE model. The model fitting, bode plot, step response and residual plot are obtained by using System Identification Toolbox in MATLAB. In this report, the mathematical equation which is used to calculate the parameters will be explained first before further discussion on results acquired from MATLAB.

4.1 Model Structures

ARX Model

In most cases, ARX model will be tried first and other complex model structures will be examined only if ARX doesn't give a satisfactory result. For ARX model, **linear least square technique (LSE)** is used to estimate the parameters since the prediction error is linear in the parameters. A system's input and output at time, t , can denote by $u(k)$ and $y(k)$. The basic relationship between the input and output is the linear difference equation.

The ARX model is described by;

$$A(q)y(k) = B(q)u(k) + v(k) \quad [4.1]$$

The difference equation with time delay will be;

$$y(k) = -a_1y(k-1) - a_2y(k-2) - \dots - a_{n_a}y(k-n_a) \quad [4.2] \\ + b_1u(k-(1+n_k)) + b_2u(k-(2+n_k)) + \dots + b_{n_b}u(k-(n_b+n_k))$$

When measuring with noise, the equation will be as follows;

$$y(k) = -a_1y(k-1) - a_2y(k-2) - \dots - a_{n_a}y(k-n_a) \quad [4.3] \\ + b_1u(k-1-n_k) + b_2u(k-(2+n_k)) + \dots + b_{n_b}u(k-(n_b+n_k)) \\ + e(k)$$

The ARX predictor is;

$$\begin{aligned} \hat{y}(k+1) = & -a_1y(k) - a_2y(k-1) - \dots - a_{n_a}y(k-n_a+1) \\ & + b_1u(k-n_k) + b_2u(k-(1+n_k)) + \dots + b_{n_b}u(k-(n_b+n_k+1)) \\ & + e(k+1) \end{aligned} \quad [4.4]$$

$$\begin{aligned} \hat{y}(k+n-1) = & -a_1y(k+n-2) - a_2y(k+n-3) - \dots \\ & -a_{n_a}y(k+n-n_a-1) + b_1u(k+n-2-n_k) + b_2u(k+n-3-n_k) \\ & + b_{n_b}u(k+n-1-n_b-n_k) + e(k+n-1) \end{aligned} \quad [4.5]$$

With (4.4) and (4.5), the prediction error of an ARX model is;

$$e(k) = A(q)y(k) - B(q)u(k) \quad [4.6]$$

Or

$$e(k) = y - \hat{y}$$

The compact form of the previous equations is;

$$\mathbf{y} = \mathbf{Z}\boldsymbol{\theta} + \mathbf{e} \quad [4.7]$$

Where,

\mathbf{y} ($m \times 1$) vector of the left sides

\mathbf{Z} ($m \times n$), $m \gg n$ data matrix exactly known

$\boldsymbol{\theta}$ ($n \times 1$) unknown vector

\mathbf{e} ($m \times 1$) error – random variable

$$\mathbf{y} = \begin{bmatrix} y(k) \\ y(k+1) \\ \vdots \\ y(k+n-1) \end{bmatrix}, \quad \mathbf{e} = \begin{bmatrix} e(k) \\ e(k+1) \\ \vdots \\ e(k+n-1) \end{bmatrix}, \quad \boldsymbol{\theta} = \begin{bmatrix} a_1 \\ a_2 \\ \vdots \\ a_{n_a} \\ b_1 \\ b_2 \\ \vdots \\ b_{n_b} \end{bmatrix}$$

$$\mathbf{Z} = \begin{bmatrix} -y(k-1) \dots & -y(k-n_a) & u(k-1-n_k) \dots & u(k-(n_b+n_k)) \\ -y(k) \dots & -y(k-n_a+1) & u(k-n_k) \dots & u(k-(n_b+n_k+1)) \\ \vdots & \vdots & \vdots & \vdots \\ -y(k+n-2) \dots & -y(k+n-n_a-1) & u(k+n-2-n_k) \dots & u(k+n-1-n_b-n_k) \end{bmatrix}$$

The quadratic loss function is as follows;

$$J = \sum_{i=1}^N e^2(i) \quad [4.8]$$

If the quadratic loss function is minimized, the optimal parameters of the ARX model can be computed by least square technique (LSE) as shown below.

$$\boldsymbol{\theta} = ([\mathbf{Z}^T \mathbf{Z}])^{-1} \mathbf{Z}^T \mathbf{y} \quad [4.9]$$

ARMAX Model

ARMAX model is an extended ARX model with the introduction of the noise filter, $C(q)$. If $C(q) = 1$, the ARMAX model reduces to ARX model. This model is the most popular after ARX model. ARMAX model is more flexible compared to ARX model because it has an extended noise model. Multi stage linear least squares algorithm can be used for parameter estimation since ARMAX becomes nonlinear in its parameters. Another technique is recursive least square (RLS). In this report, iterative technique will be discussed.

The ARMAX model is described by;

$$A(q)y(k) = B(q)u(k) + C(q)v(k) \quad [4.10]$$

The difference equation with time delay and noise will be as follows;

$$\begin{aligned} y(k) = & -a_1y(k-1) - a_2y(k-2) - \dots - a_{n_a}y(k-n_a) \\ & + b_1u(k-(1+n_k)) + b_2u(k-(2+n_k)) + \dots + b_{n_b}u(k-(n_b+n_k)) \\ & + c_1e(k-(1+n_k)) + c_2e(k-(2+n_k)) + \dots + c_{n_c}e(k-(n_c+n_k)) \end{aligned} \quad [4.11]$$

The optimal ARMAX predictor is;

$$\hat{y}(k|k-1) = \frac{B(q)}{C(q)}u(k) + \left(1 - \frac{A(q)}{C(q)}\right)y(k) \quad [4.12]$$

The prediction error of an ARMAX model is;

$$e(k) = \frac{A(q)}{C(q)}y(k) - \frac{B(q)}{C(q)}u(k) \quad [4.13]$$

(4.13) is nonlinear in its parameters because of the filter $1/C(q)$. However, the prediction error can be expressed in pseudo linear form as shown below;

$$C(q)e(k) = A(q)y(k) - B(q)u(k) \quad [4.14]$$

which can be written as;

$$e(k) = A(q)y(k) - B(q)u(k) + (1 - C(q))e(k) \quad [4.15]$$

The difference equation will be;

$$\begin{aligned} e(k) = & a_1y(k-1) + a_2y(k-2) + \dots + a_{n_a}y(k-n_a) \quad [4.16] \\ & - b_1u(k-(1+n_k)) - b_2u(k-(2+n_k)) - \dots - b_{n_b}u(k-(n_b+n_k)) \\ & - c_1e(k-(1+n_k)) - c_2e(k-(2+n_k)) - \dots - c_{n_c}e(k-(n_c+n_k)) \end{aligned}$$

Multistage least squares for ARMAX model estimation;

1. An ARX model is estimated $A(q)y(k) = B(q)u(k) + v(k)$ from the $\{u(k), y(k)\}$ data by;

$$\hat{\boldsymbol{\theta}}_{ARX} = ([\mathbf{Z}^T \mathbf{Z}])^{-1} \mathbf{Z}^T \mathbf{y} \quad [4.17]$$

2. Prediction errors of this ARX model is calculated as shown below;

$$e_{ARX}(k) = \hat{A}(q)y(k) - \hat{B}(q)u(k) \quad [4.18]$$

In which $\hat{B}(q)$ and $\hat{A}(q)$ are determined by $\hat{\boldsymbol{\theta}}_{ARX}$.

3. The ARMAX model parameters a_n , b_n , and c_n from (4.16) is estimated with least square technique (LS) by approximating the ARMAX residuals as $e(k-n) \approx e_{ARX}(k-n)$.

❖ Step 2 to 3 will be iterated until convergence is reached.

OE Model

OE model is the simplest descriptive of the output error model class. In equation error models, noise are assumed to be disturbed inside the process, but in this case, the noise will disturb the process at output. Since output error models are more realistic, they perform better than equation error models. OE models are nonlinear in their parameters and difficult to estimate as the noise model does not include the denominator which is $1/A(q)$. In order to estimate the parameters, repeated linear least squares and filtering is used.

The OE model is described by;

$$y(k) = \frac{B(q)}{F(q)}u(k) + v(k) \quad [4.19]$$

The difference equation with time delay will be;

$$y(k) = -f_1y(k-1) - f_2y(k-2) - \dots - f_{n_f}y(k-n_f) \quad [4.20] \\ + b_1u(k-(1+n_k)) + b_2u(k-(2+n_k)) + \dots + b_{n_b}u(k-(n_b+n_k))$$

When n measuring with noise, the equation will be as follows;

$$y(k) = -f_1y(k-1) - f_2y(k-2) - \dots - f_{n_f}y(k-n_f) \quad [4.21] \\ + b_1u(k-1-n_k) + b_2u(k-(2+n_k)) + \dots + b_{n_b}u(k-(n_b+n_k)) \\ + e(k)$$

The optimal OE predictor is;

$$\hat{y}(k|k-1) = \hat{y} = \frac{B(q)}{F(q)}u(k) \quad [4.22]$$

The notation ' $|k-1$ ' can be negated because the optimal prediction is not based on the previous outputs.

$$\hat{y}(k) = -f_1\hat{y}(k-1) - f_2\hat{y}(k-2) - \dots - f_{n_f}\hat{y}(k-n_f) \quad [4.23] \\ + b_1u(k-1-n_k) + b_2u(k-(2+n_k)) + \dots + b_{n_b}u(k-(n_b+n_k))$$

The prediction error of an OE model is;

$$e(k) = y(k) - \frac{B(q)}{F(q)}u(k) \quad [4.24]$$

ARX model residuals can be interpreted as filtered OE residuals;

$$e_{ARX}(k) = F(q)e_{OE}(k) \quad [4.25]$$

Repeated least squares and filtering approach for OE model estimation;

1. An ARX model is estimated $F(q)y(k) = B(q)u(k) + v(k)$ from the $\{u(k), y(k)\}$ data by;

$$\hat{\boldsymbol{\theta}}_{ARX} = ([\mathbf{Z}^T \mathbf{Z}])^{-1} \mathbf{Z}^T \mathbf{y} \quad [4.26]$$

where the parameter of f_n is used instead of a_n in $\hat{\boldsymbol{\theta}}$.

2. The input $u(k)$ and $y(k)$ is filtered through the estimated filter $\hat{F}(q)$;

$$u^F(k) = \frac{1}{\hat{F}(q)} u(k) \text{ and } y^F(k) = \frac{1}{\hat{F}(q)} y(k) \quad [4.27]$$

3. The OE model parameters f_n and b_n are estimated by an ARX model estimation with filtered input $u^F(k)$ and output $y^F(k)$.

❖ Step 2 to 3 will be iterated until convergence is reached.

4.2 Simulation in MATLAB Environment

In this report, System Identification Toolbox in MATLAB is used extensively after the completion of mathematics for each model, ARX, ARMAX and OE model. The coding in MATLAB follows the mathematical equations for each model as shown in equations above (4.1) to (4.26). System identification is extremely helpful to identify systems in which it is difficult to model from principles. It requires measured input and output data to estimate the values of parameters in each model structure. In this section, mathematical modelling will be formulated by using MATLAB in order to find the model fitting, bode diagram, step response and residual plots. Three systems were analysed. For each system, there will be two responses, which include first order plus time delay (FOPTD), and second order plus time delay (SOPTD). Five case studies with different orders are discussed in the following section.

Polynomial orders $[n_a \ n_b \ n_k]$ define the orders of an ARX model. (n_a) describes the order of the polynomial $A(q)$, (n_b) is the order of the polynomial $B(q) + 1$ and (n_k) is the input-output delay expressed as fixed leading zeroes of the B polynomial. Besides that, polynomial orders $[n_a \ n_b \ n_c \ n_k]$ define the orders of ARMAX and $[n_b \ n_c \ n_k]$ define the order of OE model. (n_c) describes the order of the $C(q)$ for ARMAX and $F(q)$ for OE.

For each case study, six types of graph are discussed. First graph shows the comparison of model output with the actual measured value. It describes the goodness of fit of a model which typically summarizes the difference between measured values and predicted values. Second graph is the step response where it refers to the response of a system to the unit step. The duration of the simulation is determined automatically, based on the system poles and zeroes. Third graph shows the bode plot. It's a graph of frequency response where gain and phase are presented in different plots. Fourth, fifth and sixth graphs are the residual plots for OE, ARMAX and ARX model. The top axes show the autocorrelation of residuals for the output which is known as whiteness test. The x-axis indicates the number of lags that describes the time difference (in data) between the signals at which the correlation is estimated. Horizontal line on the plot is the confidence limit. Besides that, the bottom plot refers to the cross-correlation of the residuals with the input.

The first system used is third order system plus time delay model;

$$\text{System, } g(s) = \frac{100}{(s+2)(s+5)(s+10)} e^{-s}$$

2000 data points were used for identification, in which the range is from 1-2000, where else; 1000 points were used for validation purpose (2001-3001). The sampling time is equal to 1. Figure below shows the input $u(k)$ and output $y(k)$ which are plotted against time.

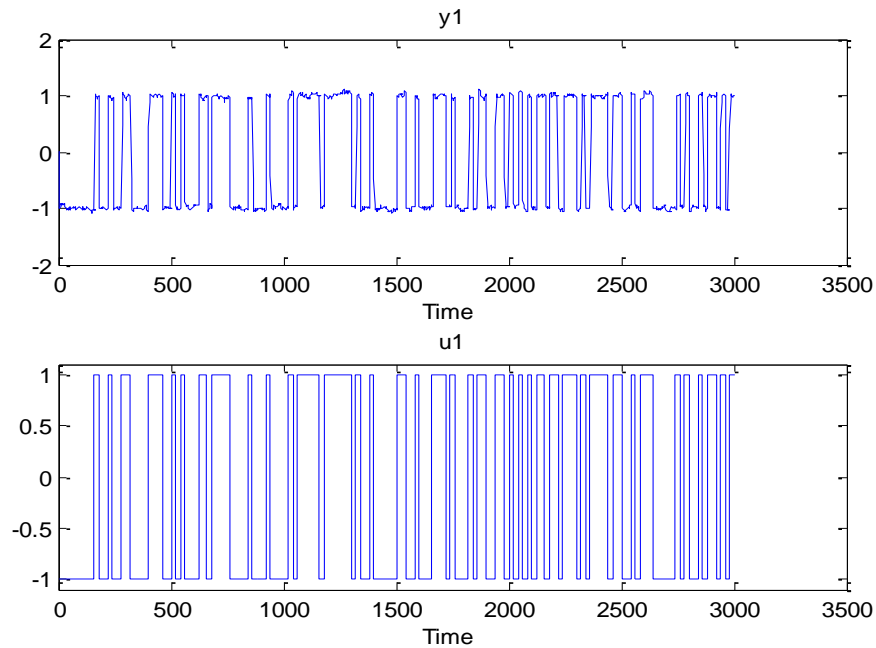

Figure 9: Input, u & Output, y vs. Time

The first 100 measured input and output values are included in Appendix 1.

The values of the parameters are estimated using prediction error by minimizing the size of error ' $e(k)$ '. Simulations in noisy environment show the effectiveness of the model. White Gaussian noise introduced in the system is termed as $e(k)$. The code used to describe this in m-file is '`noise=wgn(ndata,1,1)`', which generates $ndata \times 1$ of White Gaussian noise. The value of '1' specifies the power of y in decibels relative to watt. In addition, the input signal used is PRBS (pseudo random binary signal), with probability of shift (p) equals to 0.05, which is also known as bandwidth. This signal can have only one of the two possible values, either 1 or -1 as amplitude. The value of (p) should be small enough so that, the system will have chance to react with a significant response before the input value changes.

Case Study 1 (na:2; nb:2; nc:2)

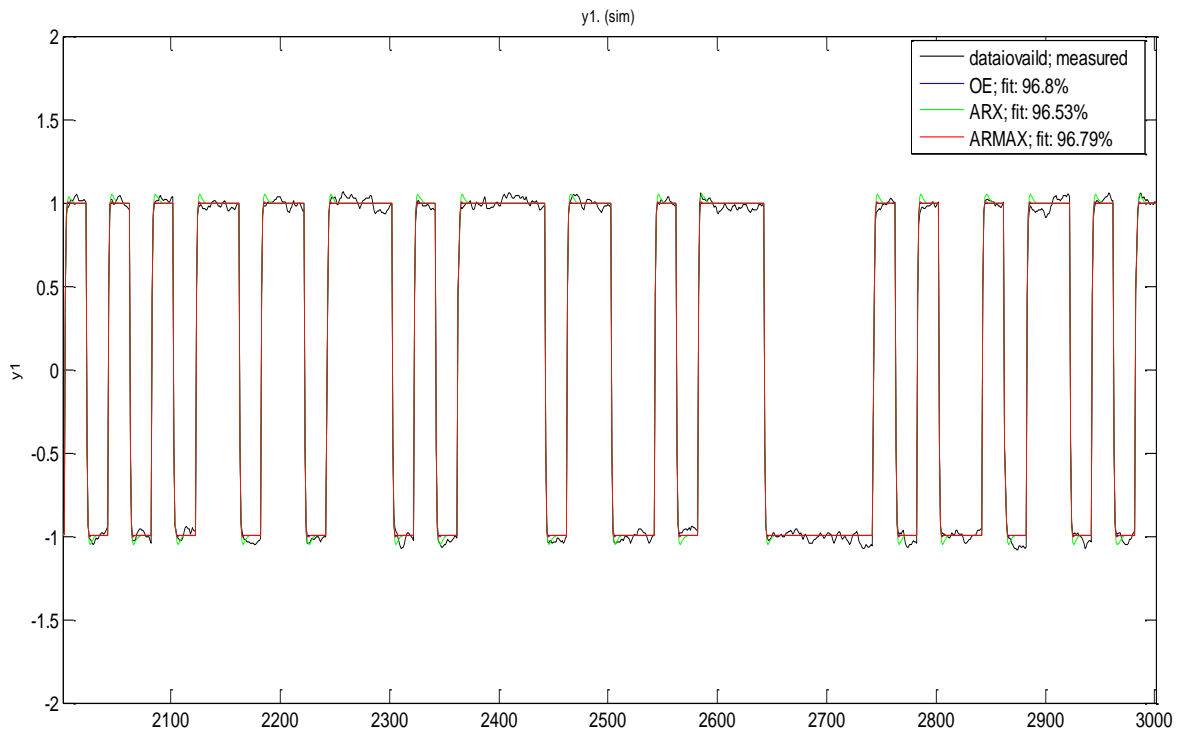

Figure 10: Comparison of model output with the actual measured values (Second Order)

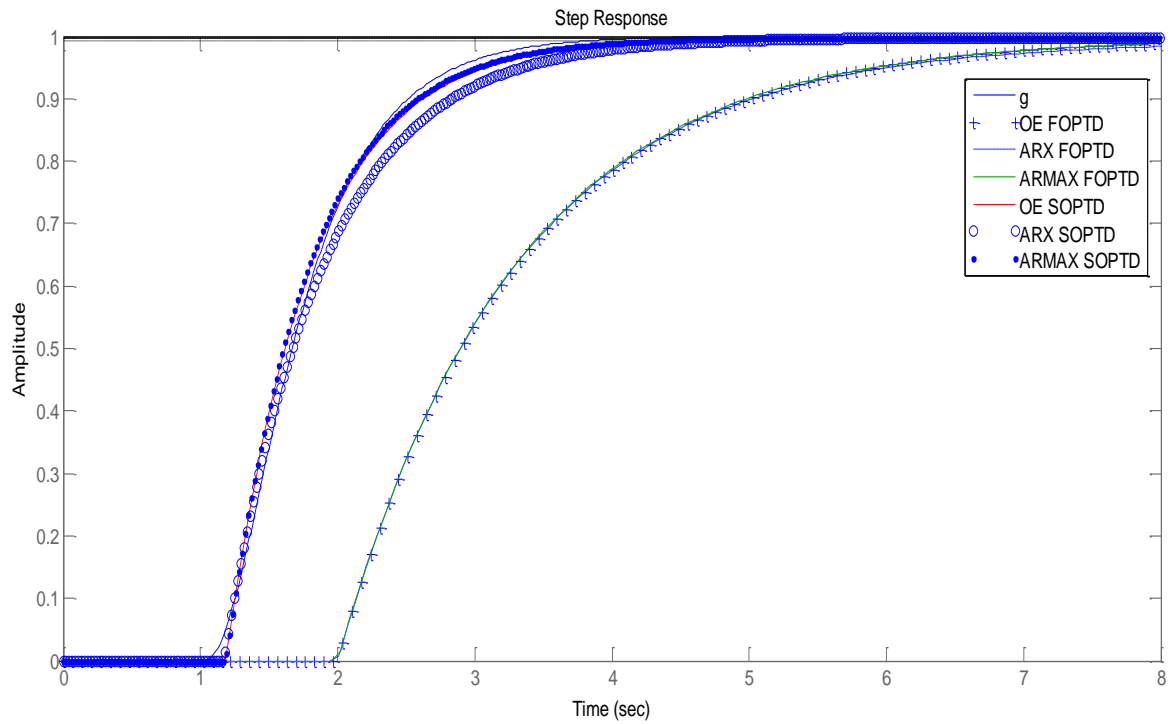

Figure 11: Step response for OE, ARX and ARMAX models (Second Order)

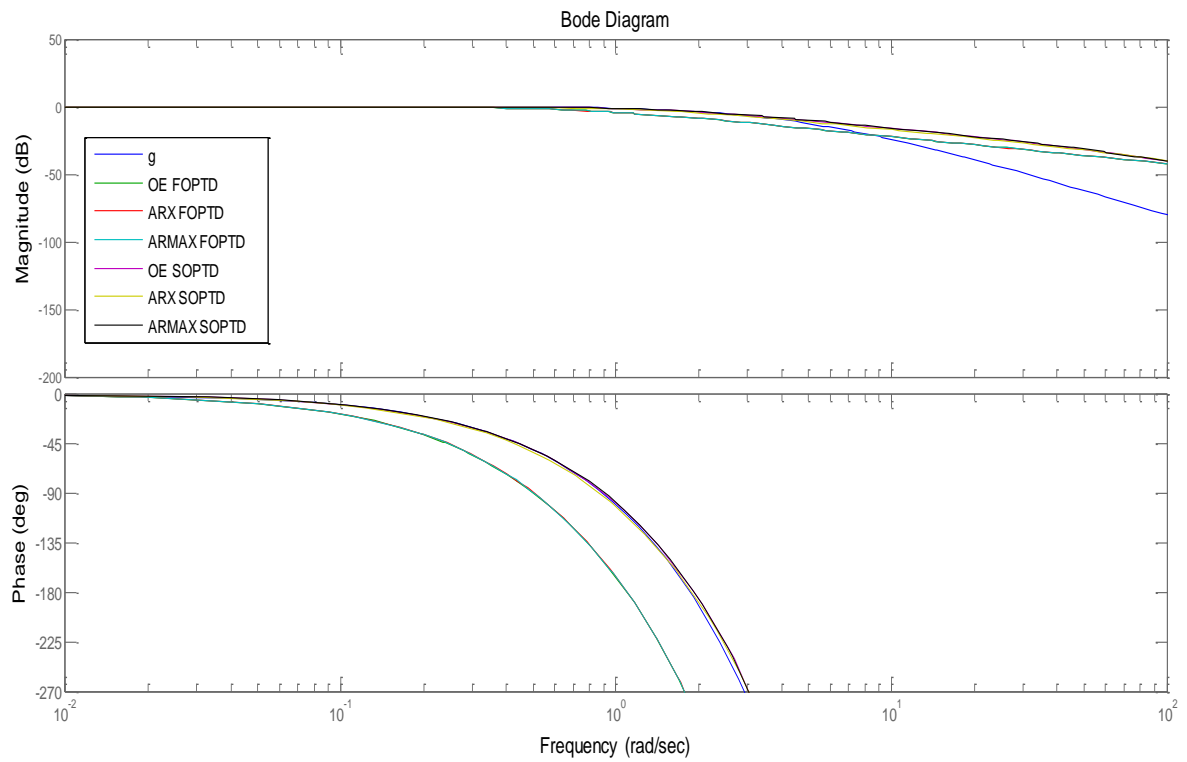

Figure 12: Bode Plot for OE, ARX and ARMAX models (Second Order)

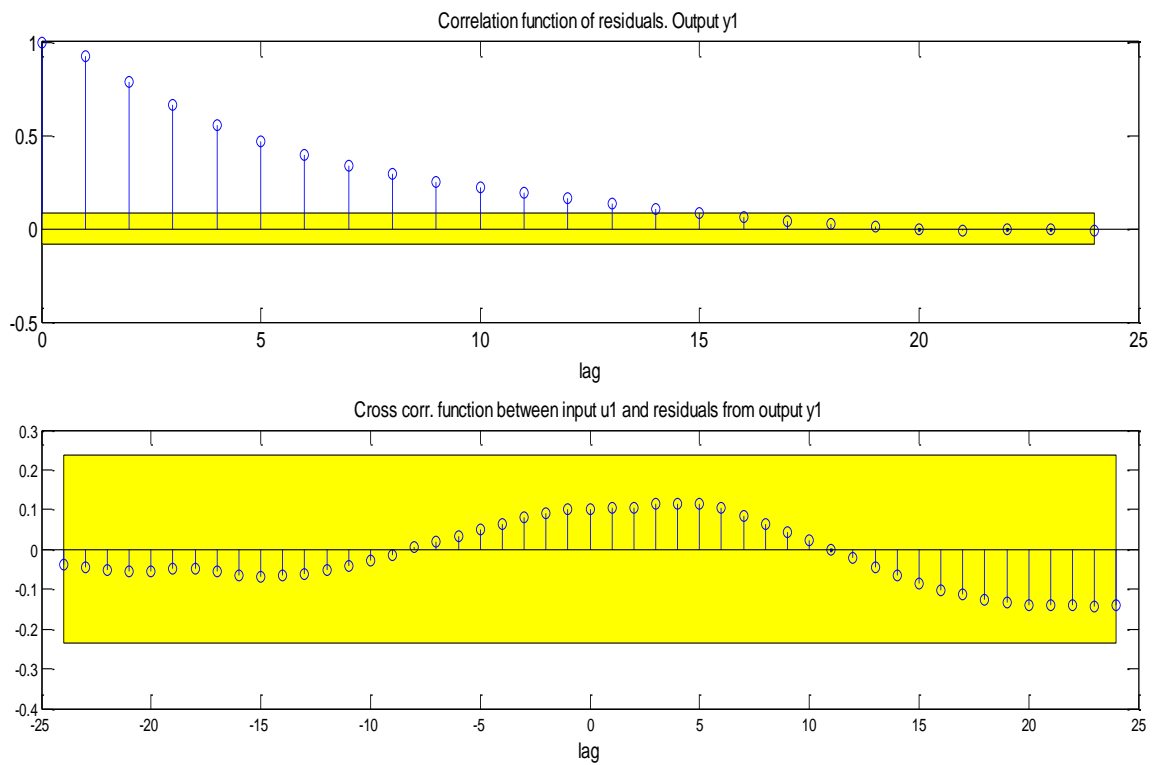

Figure 13: Residual Plot for OE (Second Order)

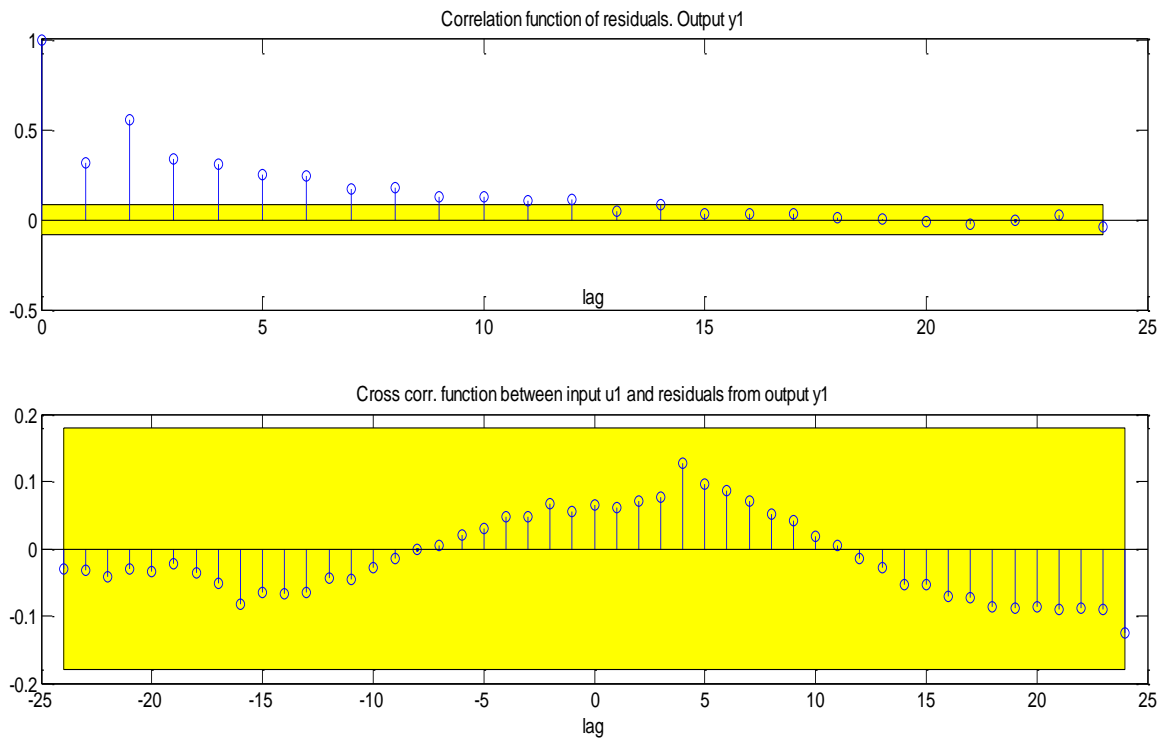

Figure 14: Residual Plot for ARMAX (Second Order)

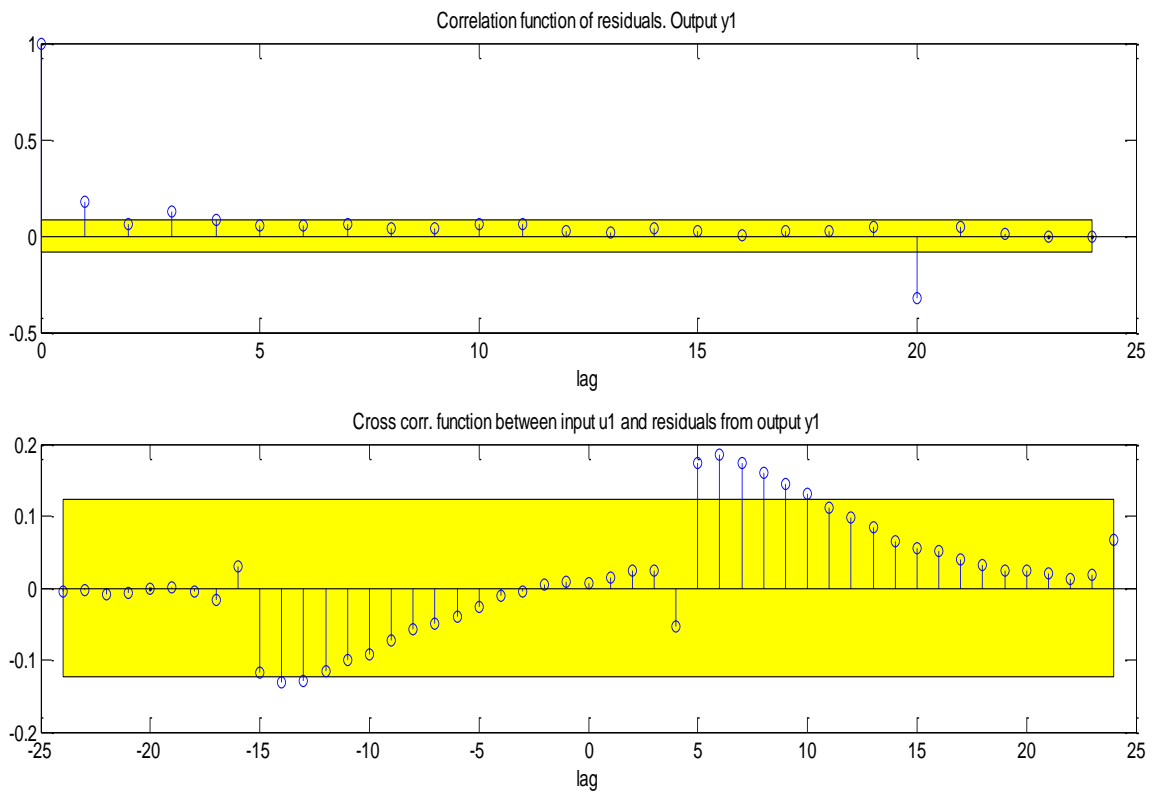

Figure 15: Residual Plot for ARX (Second Order)

Case Study 2 (na:3; nb:3; nc:3)

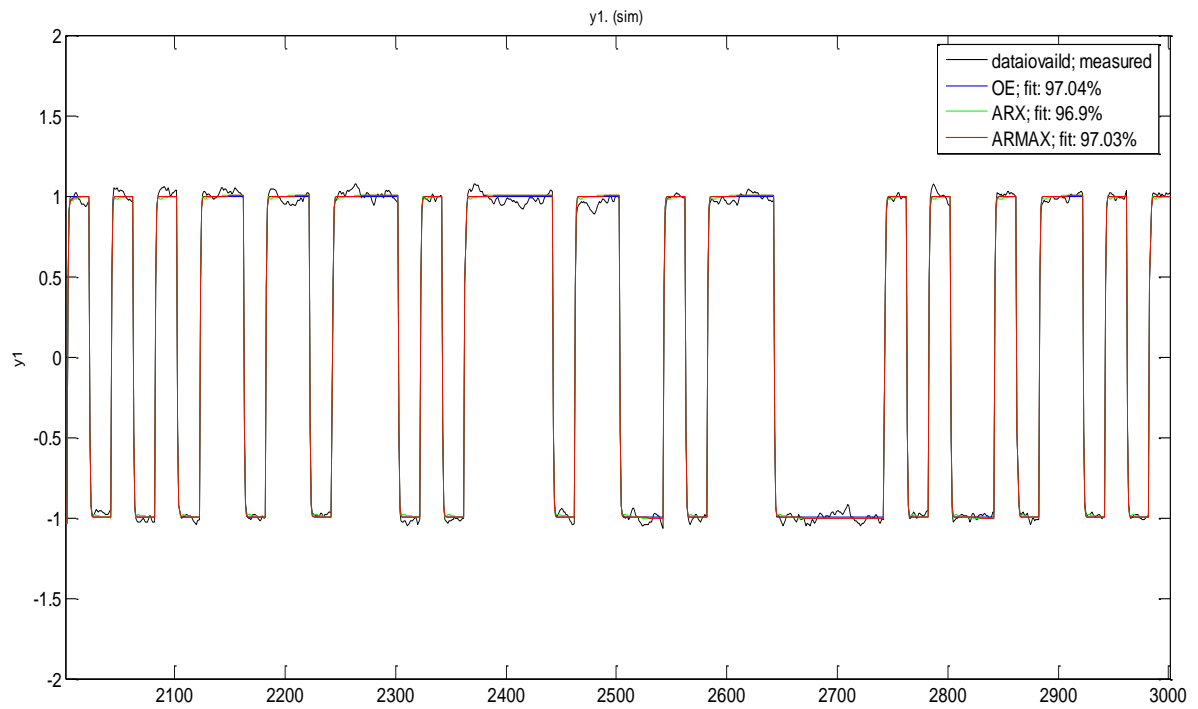

Figure 16: Comparison of model output with the actual measured values (Third Order)

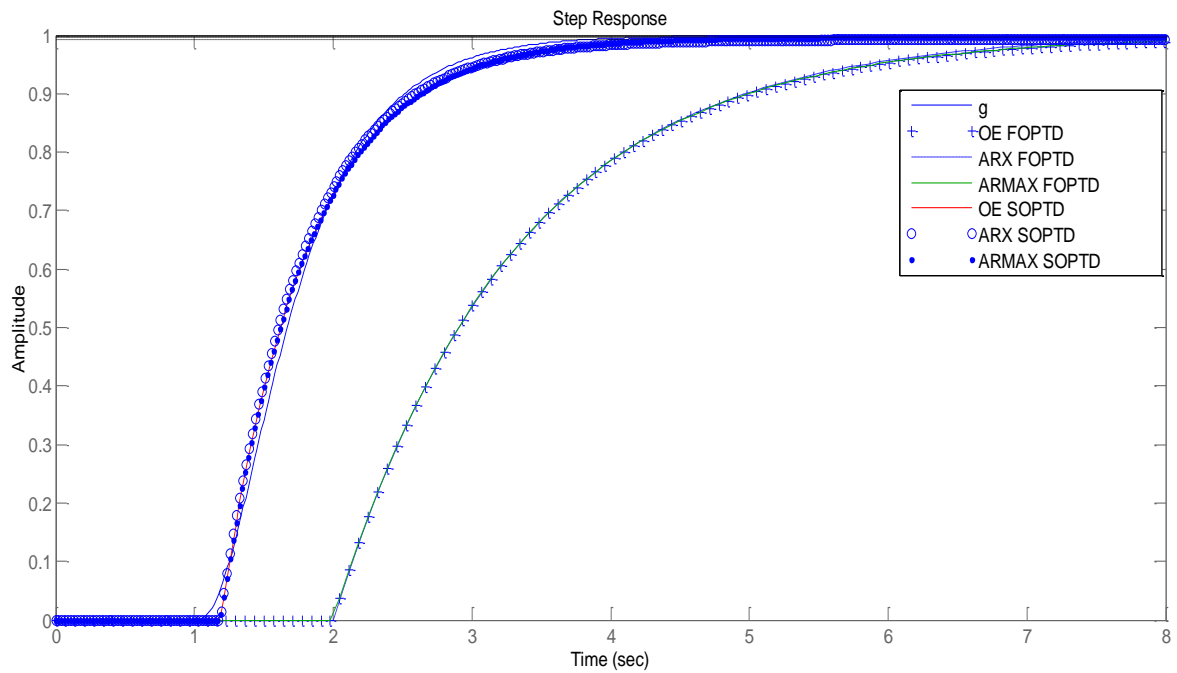

Figure 17: Step response for OE, ARX and ARMAX models (Third Order)

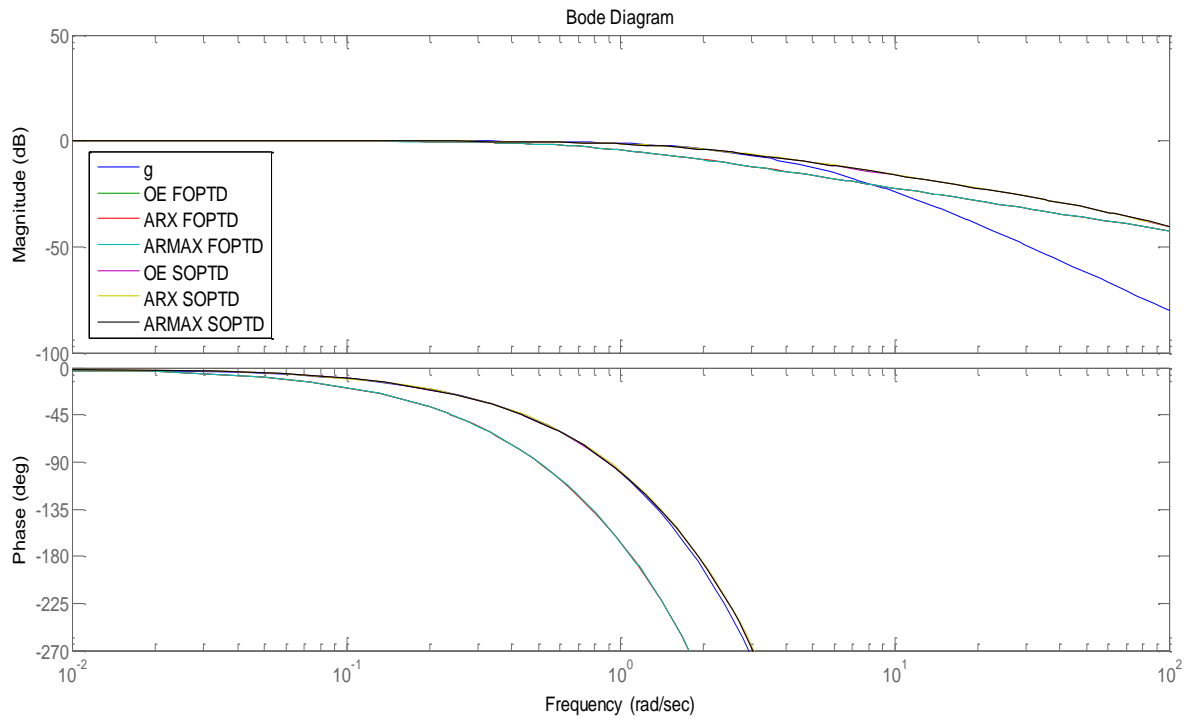

Figure 18: Bode Plot for OE, ARX and ARMAX models (Third Order)

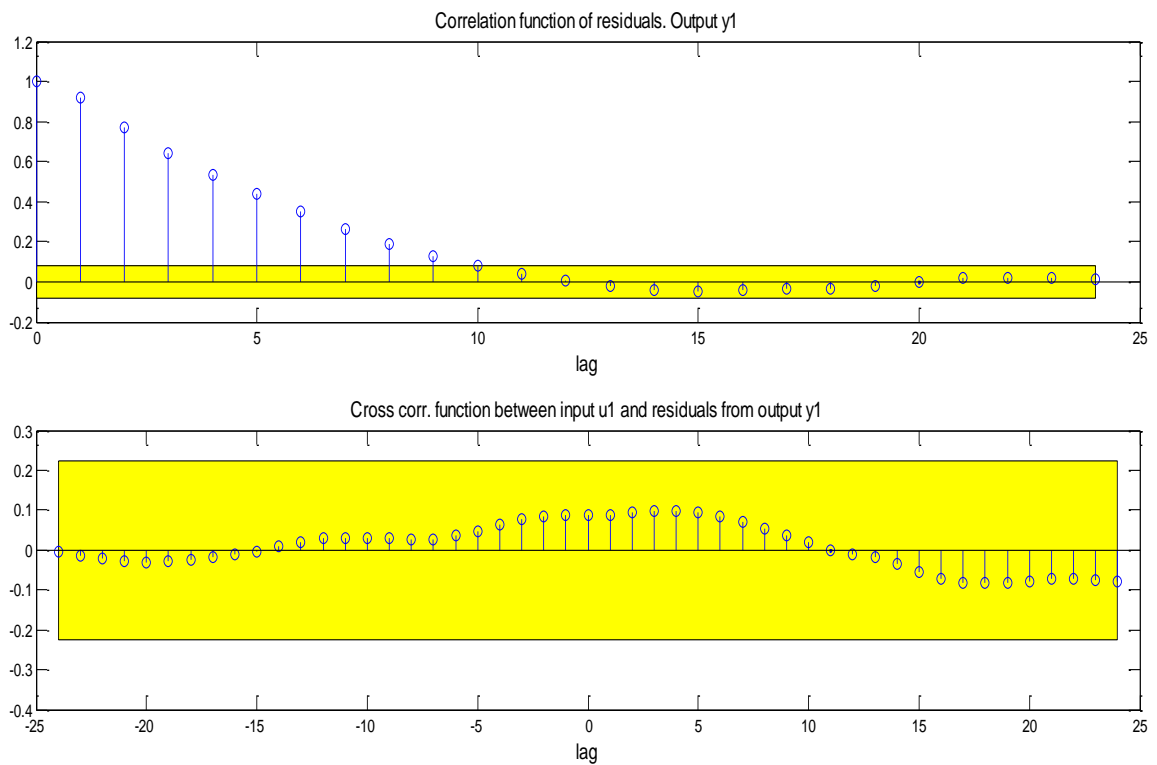

Figure 19: Residual Plot for OE (Third Order)

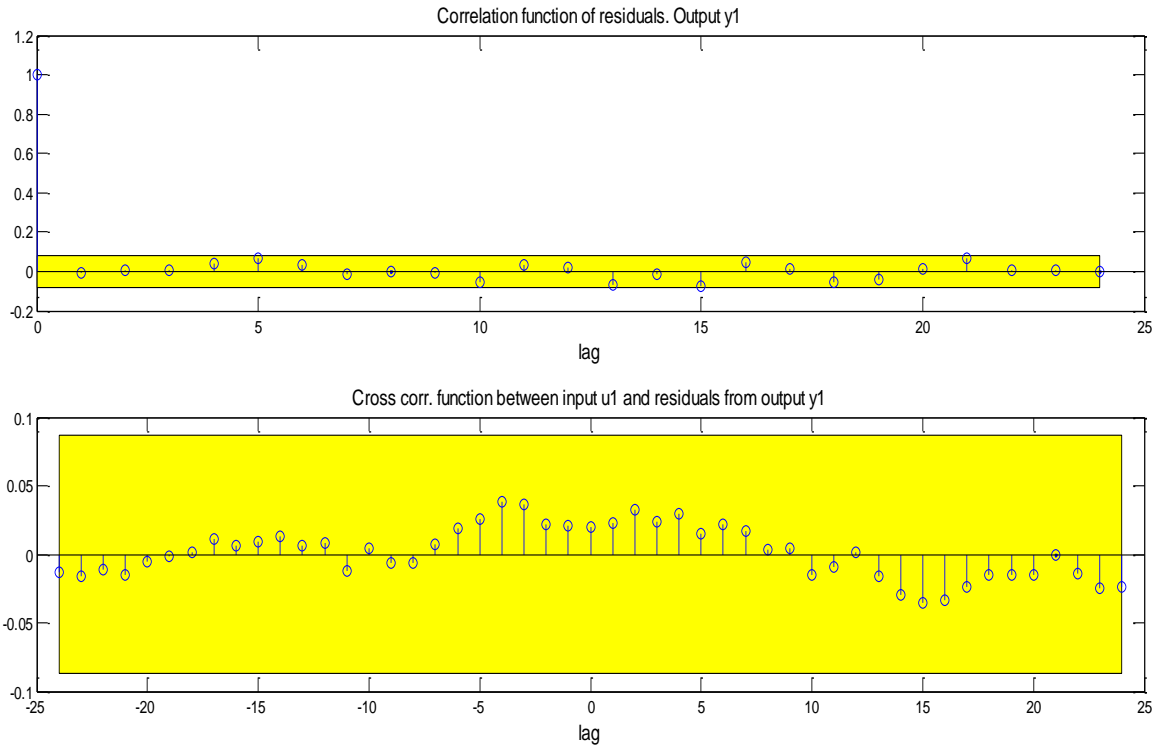

Figure 20: Residual Plot for ARMAX (Third Order)

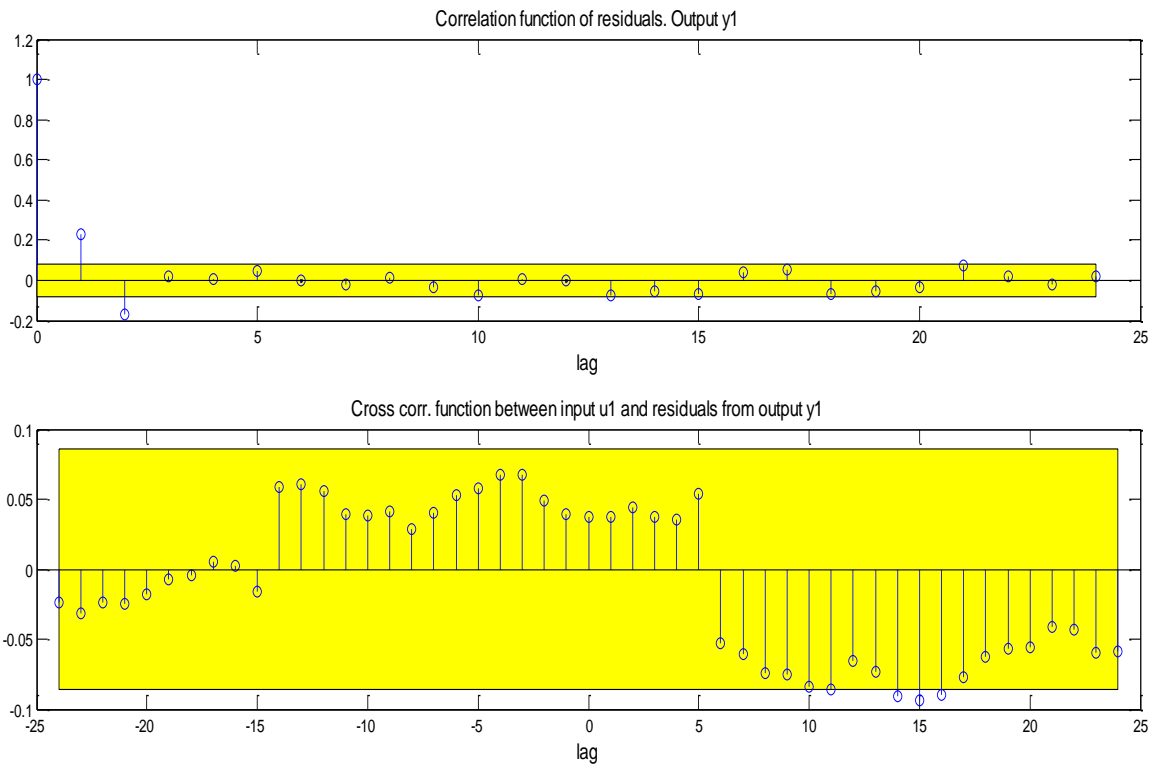

Figure 21: Residual Plot for ARX (Third Order)

Case Study 3 (na:4; nb:4; nc:4)

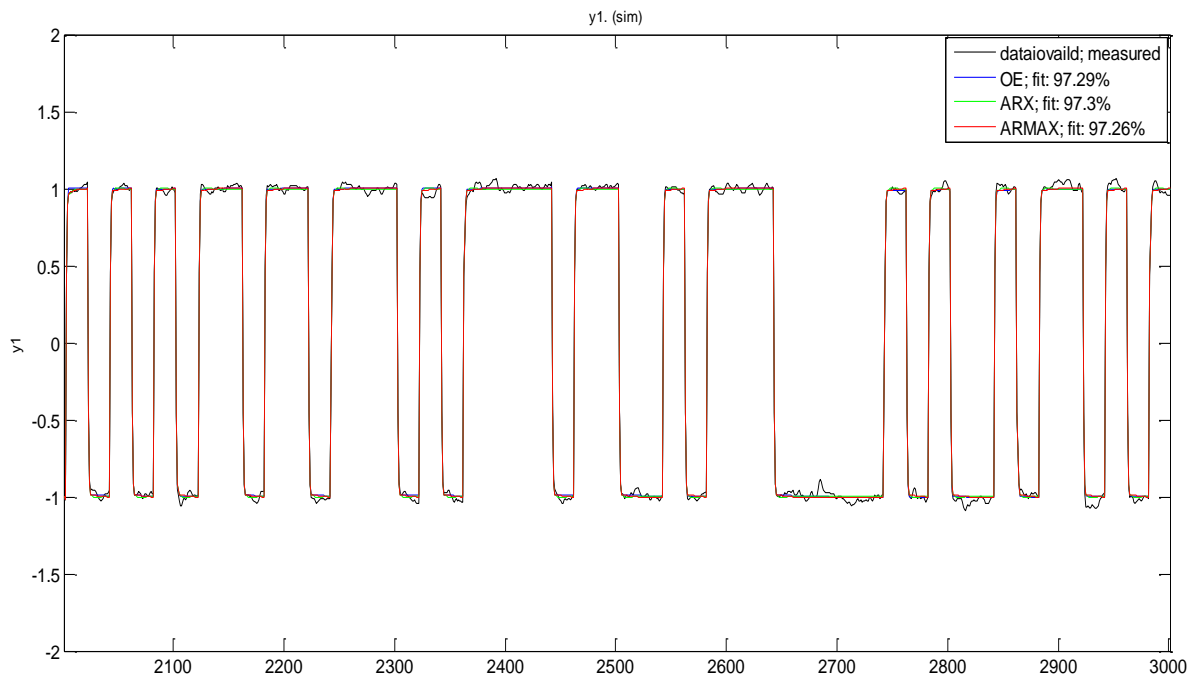

Figure 22: Comparison of model output with the actual measured values (Fourth Order)

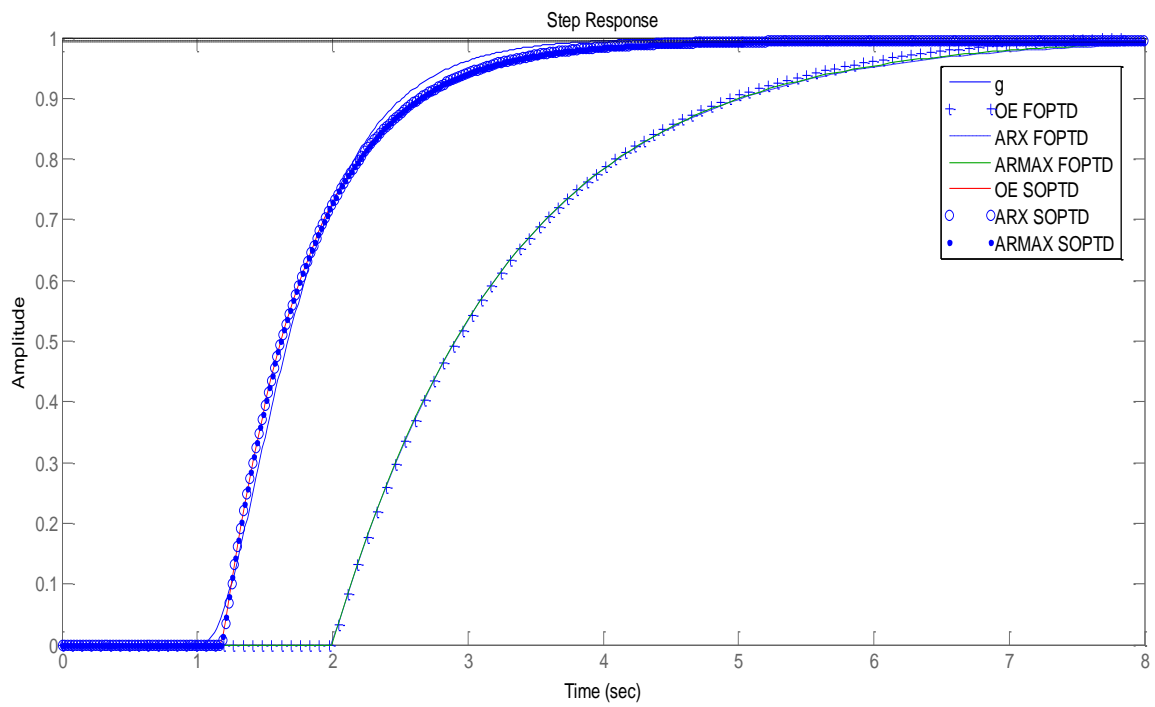

Figure 23: Step response for OE, ARX and ARMAX models (Fourth Order)

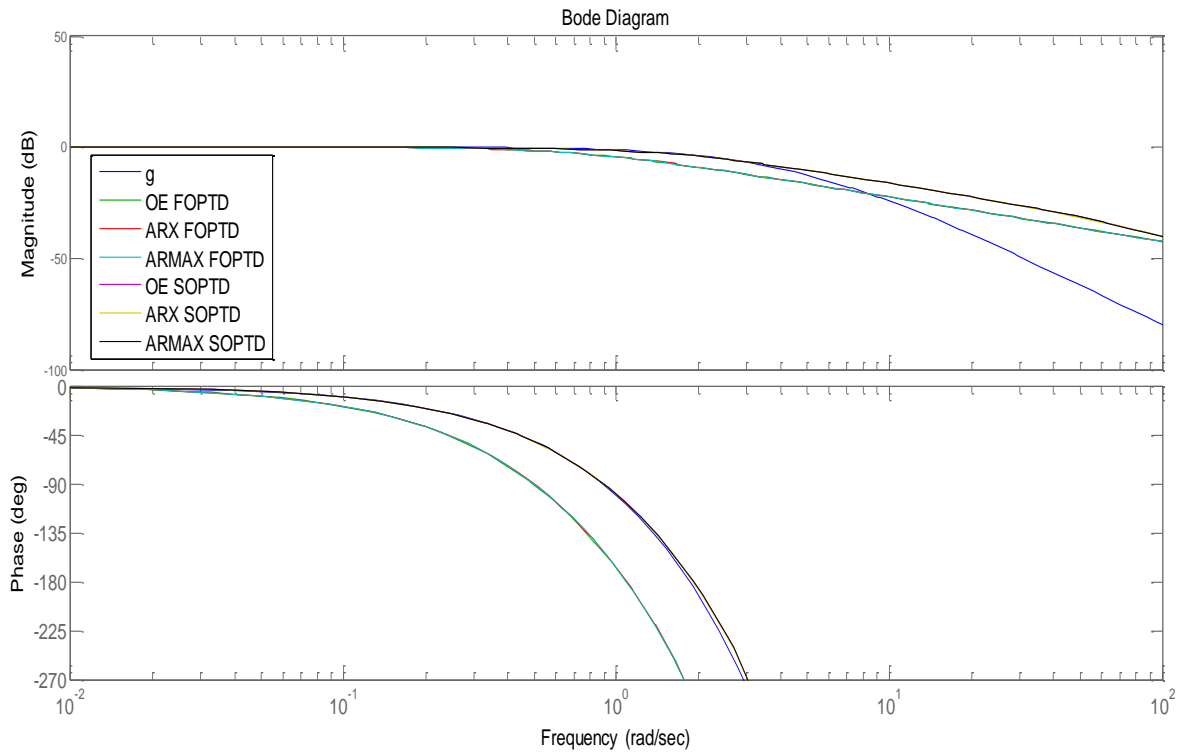

Figure 24: Bode Plot for OE, ARX and ARMAX models (Fourth Order)

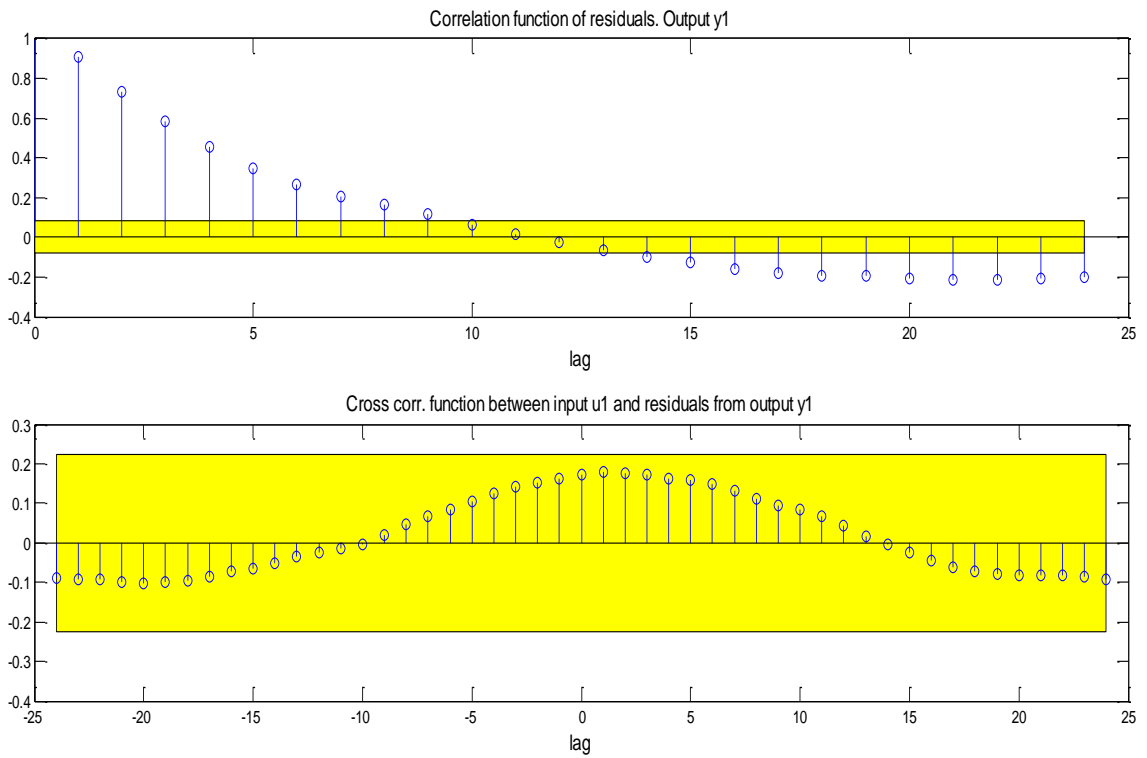

Figure 25: Residual Plot for OE (Fourth Order)

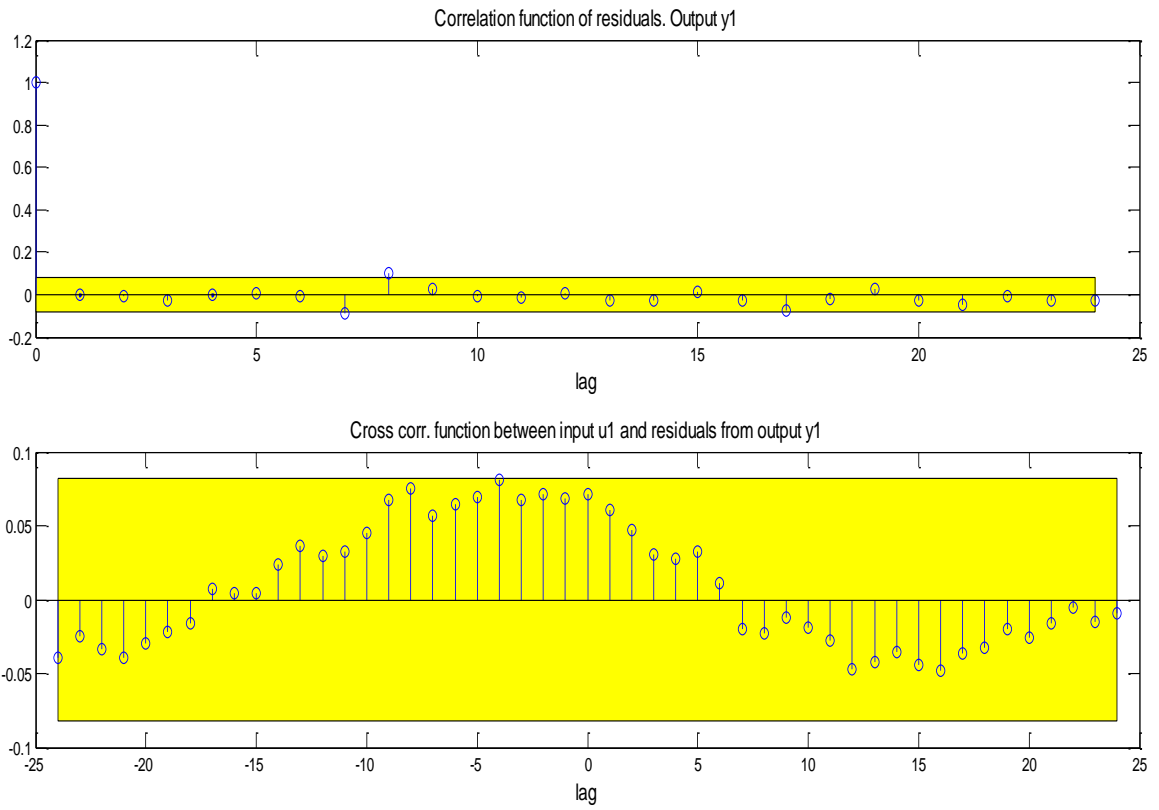

Figure 26: Residual Plot for ARMAX (Fourth Order)

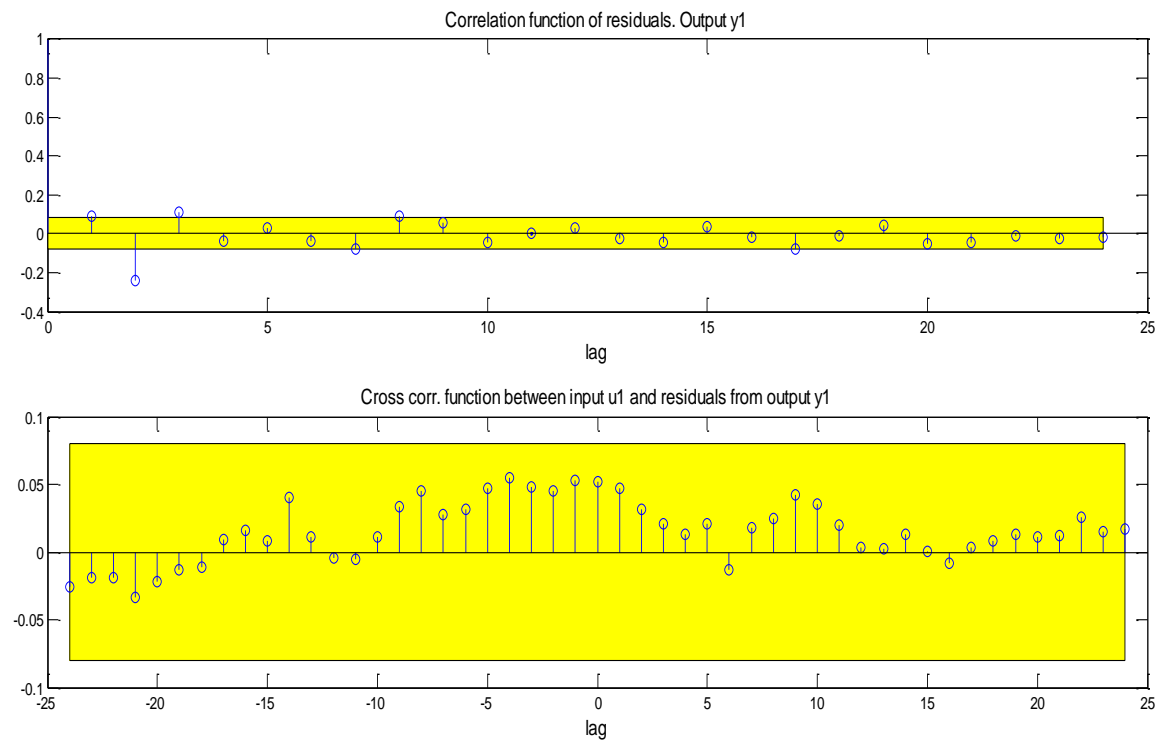

Figure 27: Residual Plot for ARX (Fourth Order)

Case Study 4 (na:5; nb:5; nc:5)

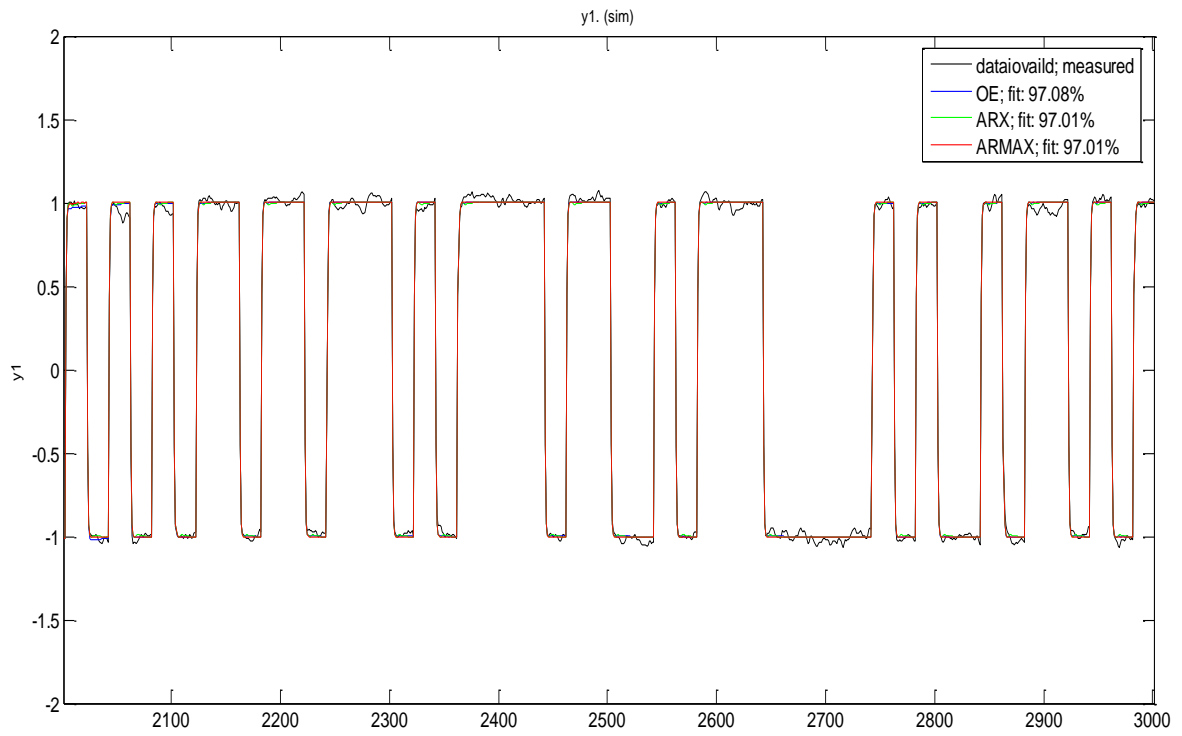

Figure 28: Comparison of model output with the actual measured values (Fifth Order)

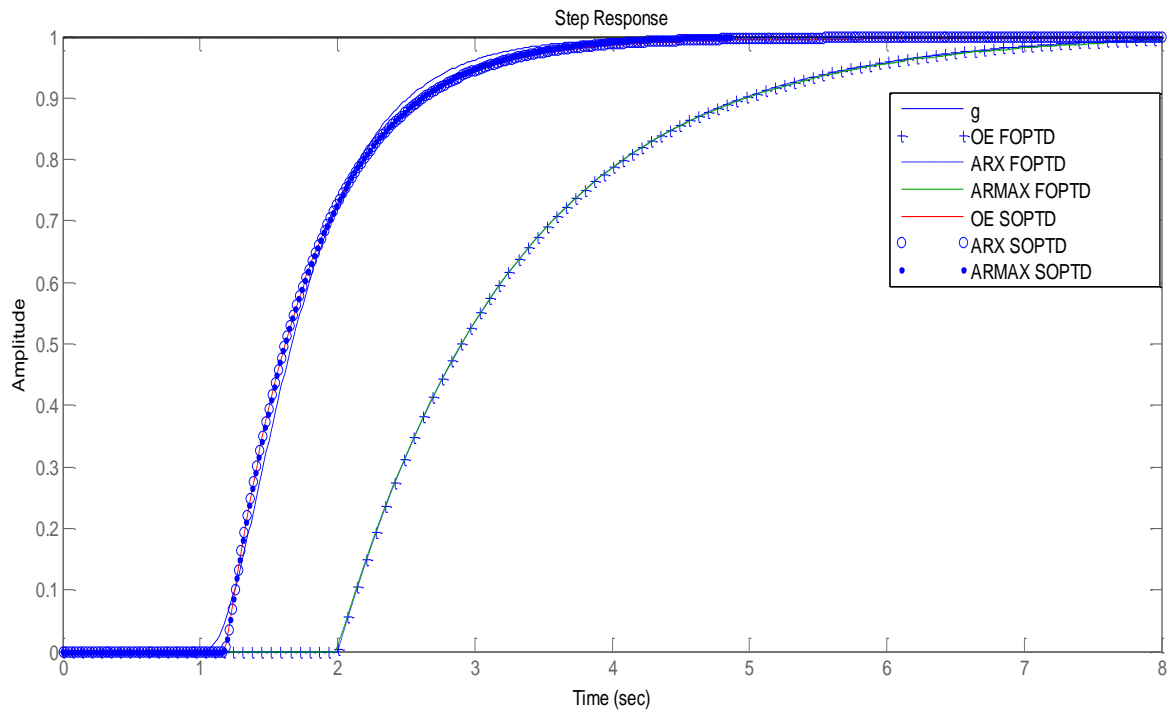

Figure 29: Step response for OE, ARX and ARMAX models (Fifth Order)

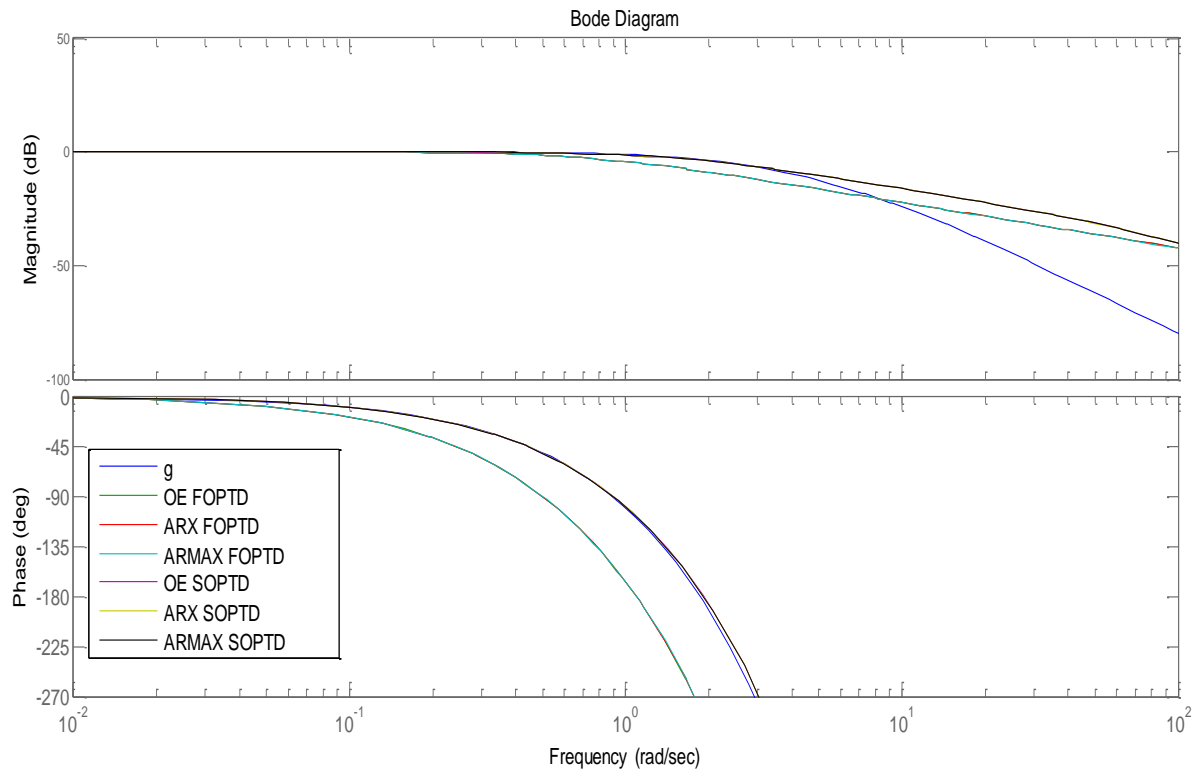

Figure 30: Bode Plot for OE, ARX and ARMAX models (Fifth Order)

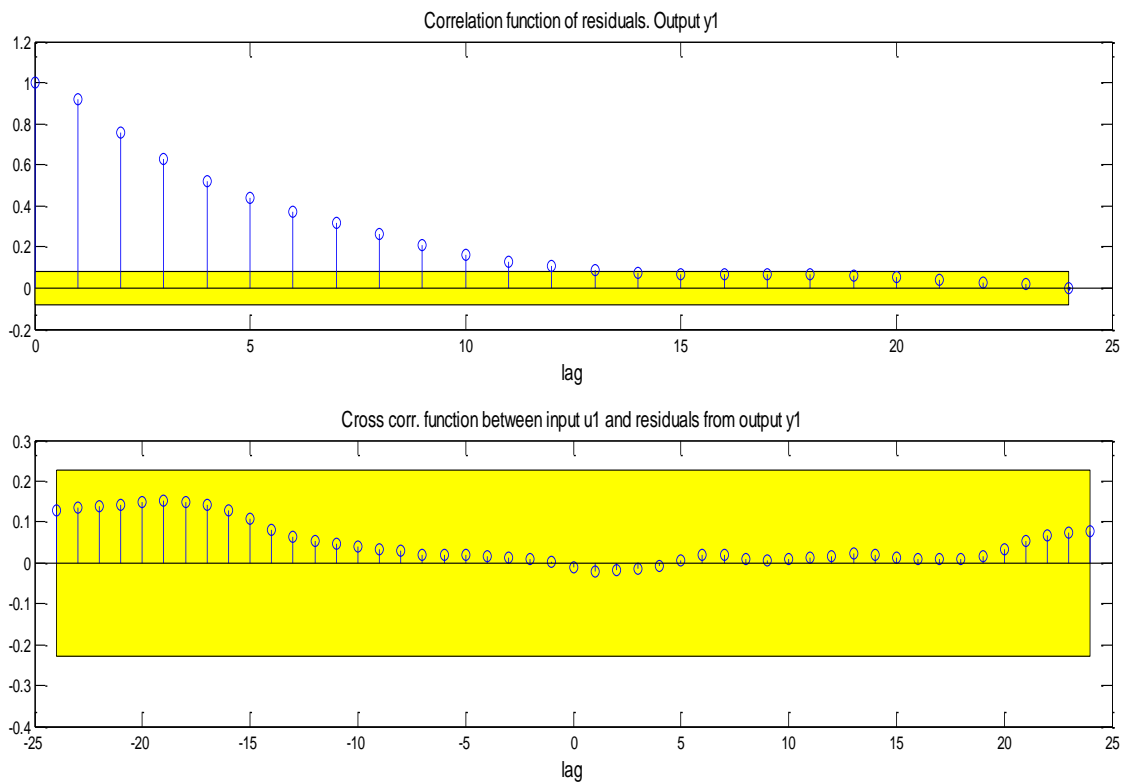

Figure 31: Residual Plot for OE (Fifth Order)

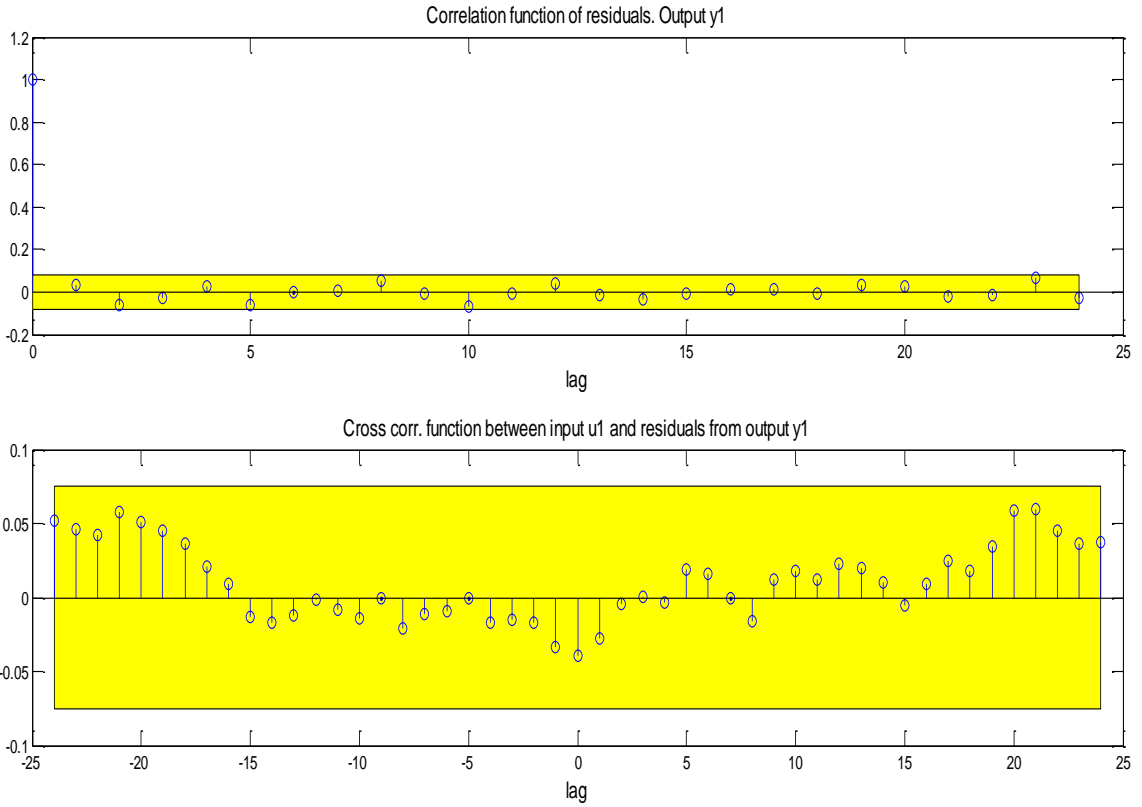

Figure 32: Residual Plot for ARMAX (Fifth Order)

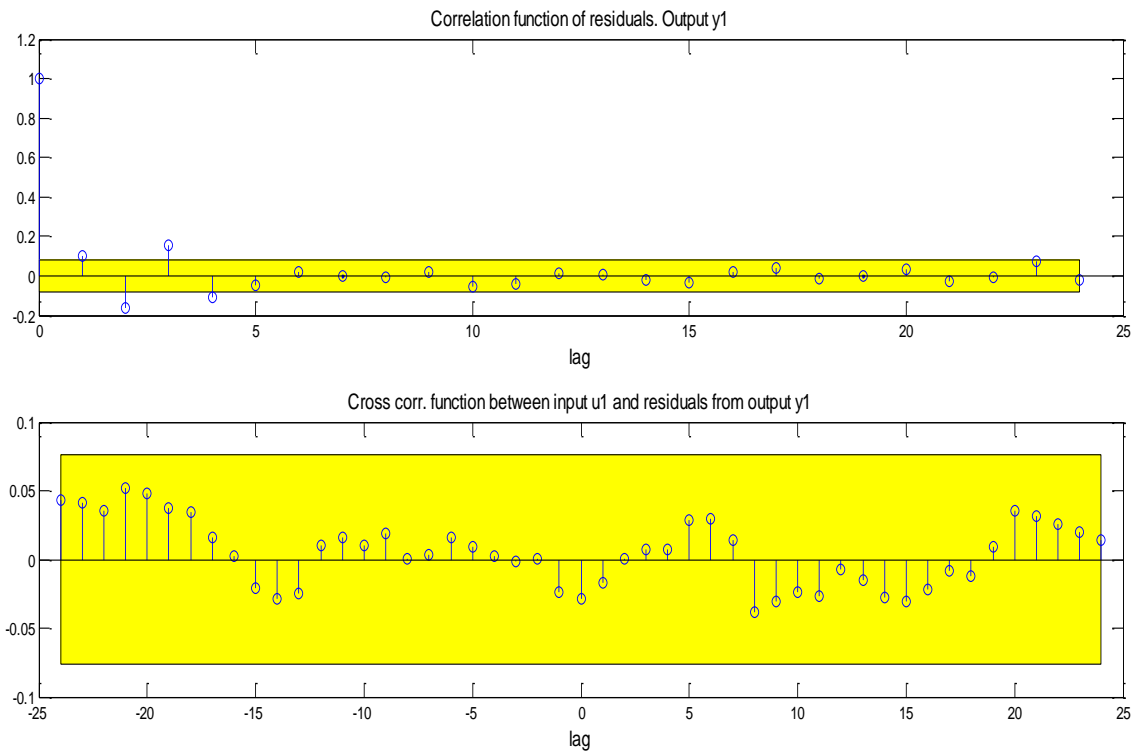

Figure 33: Residual Plot for ARX (Fifth Order)

Case Study 5 (na:6; nb:6; nc:6)

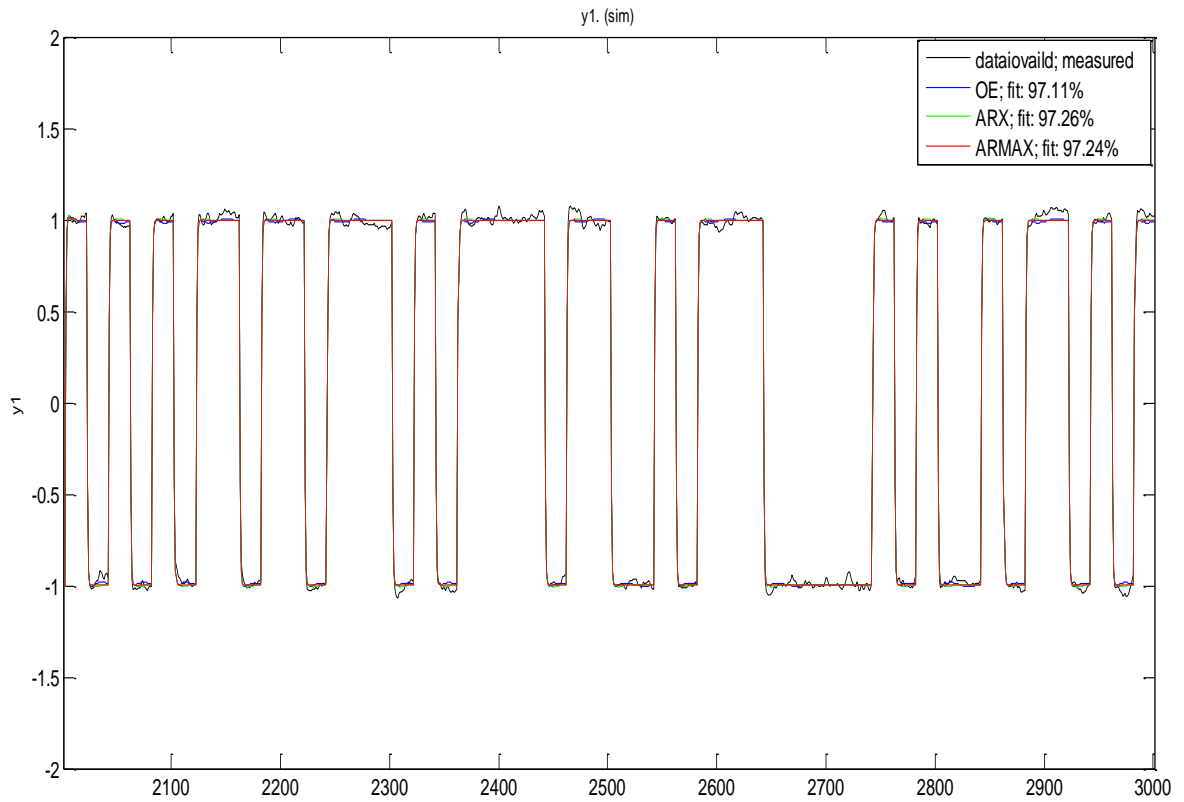

Figure 34: Comparison of model output with the actual measured values (Sixth Order)

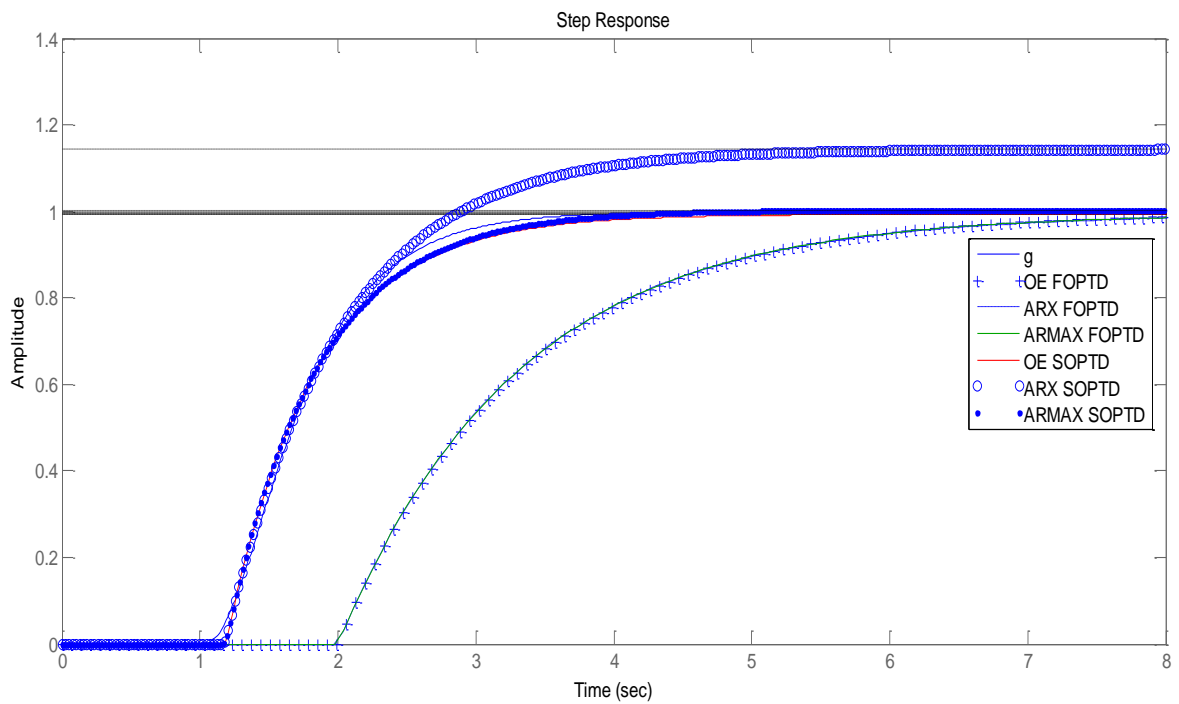

Figure 35: Step response for OE, ARX and ARMAX models (Sixth Order)

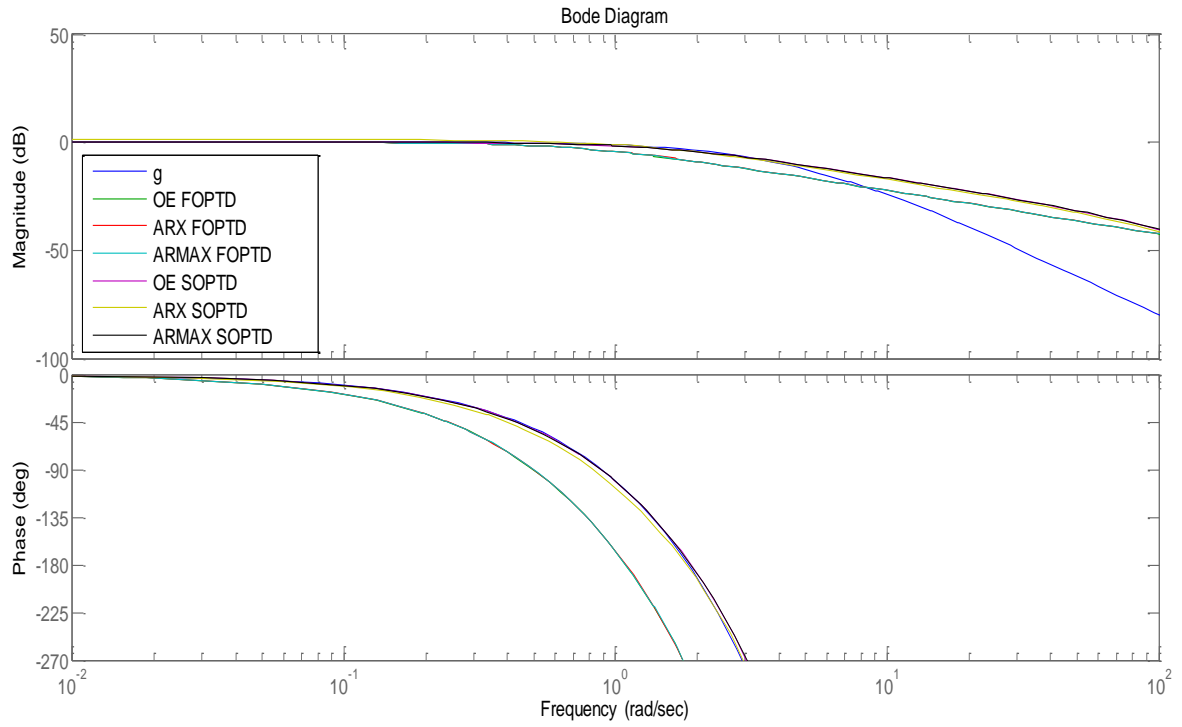

Figure 36: Bode Plot for OE, ARX and ARMAX models (Sixth Order)

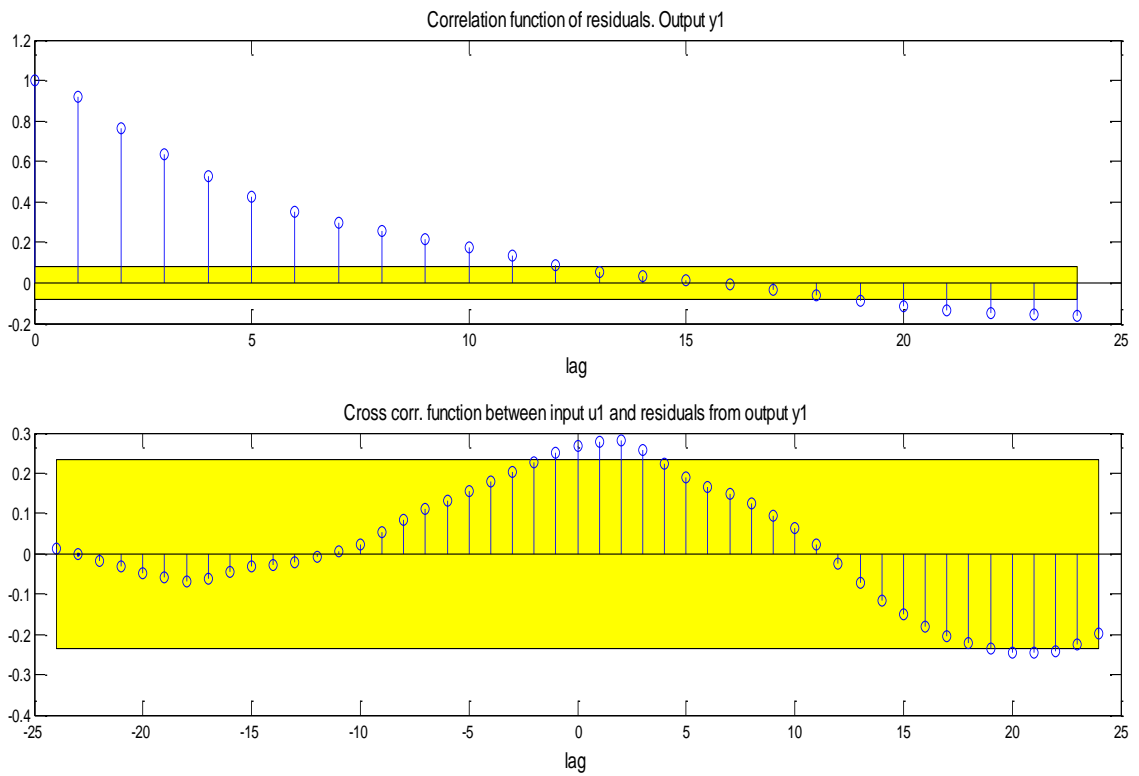

Figure 37: Residual Plot for OE (Sixth Order)

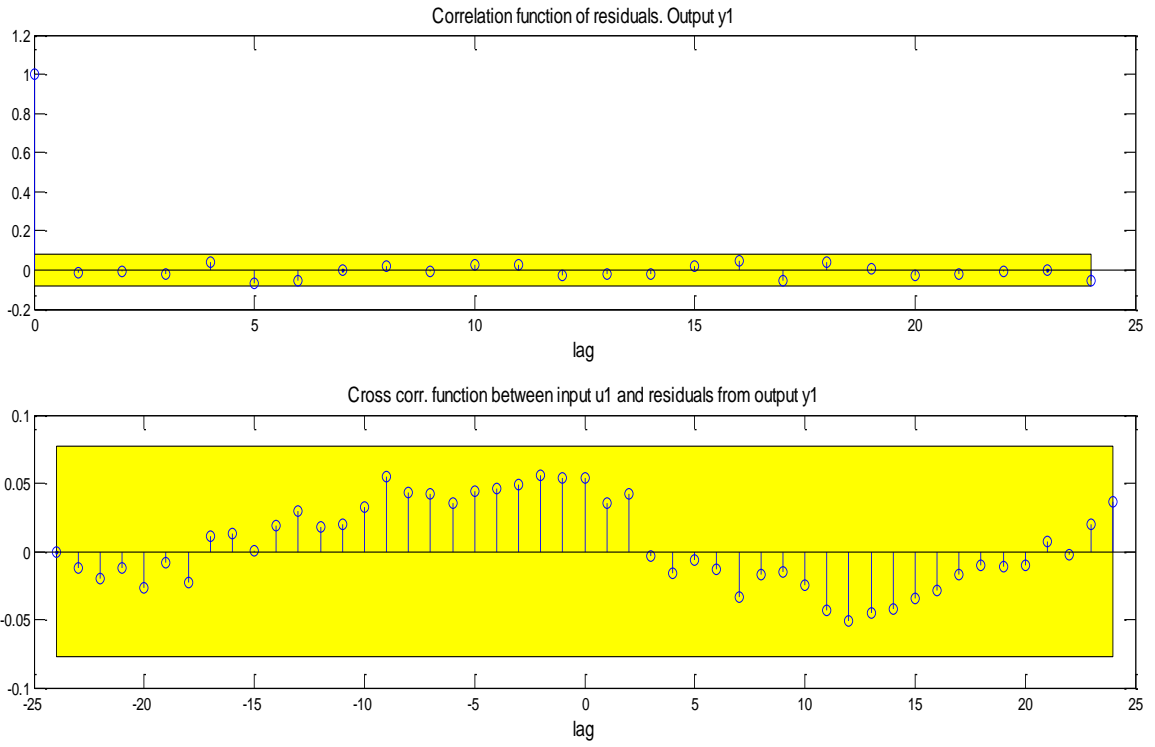

Figure 38: Residual Plot for ARMAX (Sixth Order)

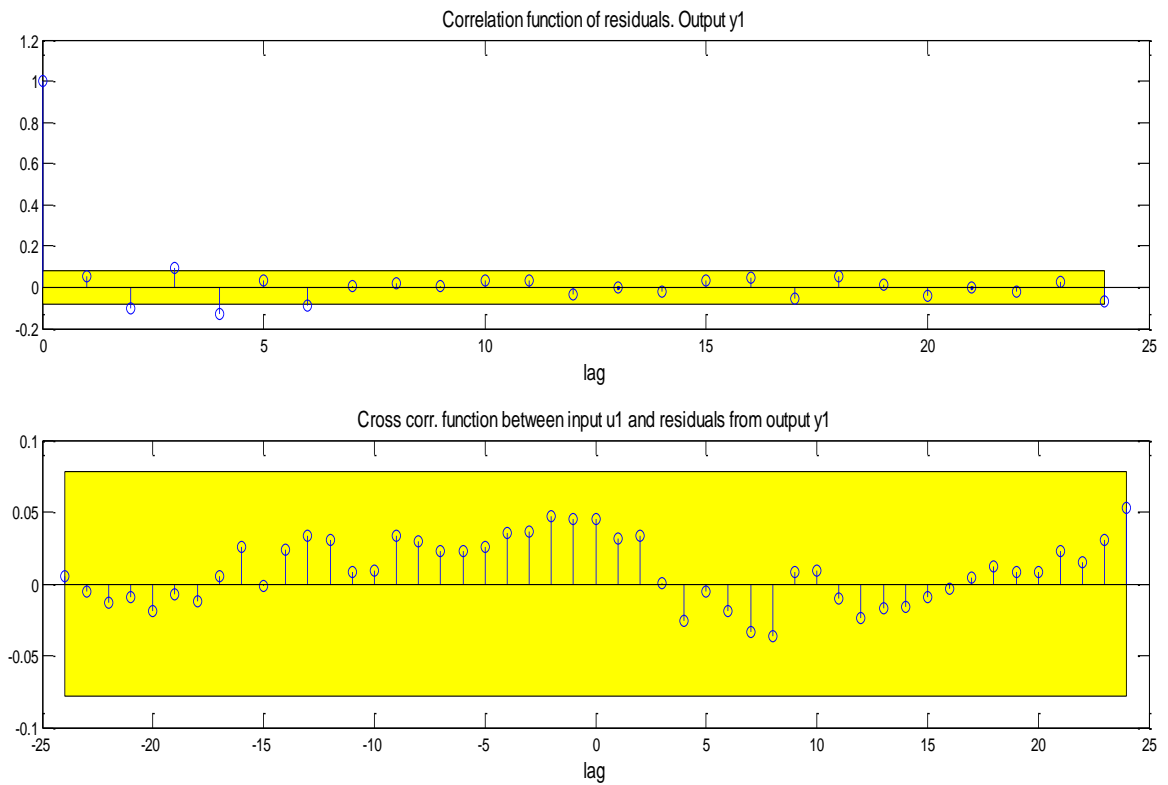

Figure 39: Residual Plot for ARX (Sixth Order)

The system is disturbed by white Gaussian noise (WGN). The ordinary least squares estimate will not be consistent if the actual measurement of the process output is ruined by white noise (Giuseppe, 2009). The reason is because the noise will be correlated noise instead of white noise. White noise is a random signal which has a constant power spectral density in signal processing. A signal is said to be white Gaussian noise (WGN) when the sample has a normal distribution with zero mean. For each case study, there are 6 types of graph that have a different explanation.

According to Figure 10 in case study 1 (model order of 2), OE model gives the best fitting which is 96.8%, followed by ARMAX (96.79%) and ARX (96.53%). Step response graph (Figure 11) shows that SOPTD lines are closer to the true system line, whereas, FOPTD lines are slightly deviated from true system line. Figure 12 shows Bode diagram for FOPTD and SOPTD systems. It can be seen that SOPTD lines of OE, ARX and ARMAX models are closer to the true system line compared to FOPTD. Figure 13, 14 and 15 display the residual plot for OE, ARMAX and ARX. There are two types of graphs in residual plot, which are correlation function of residuals (output) and cross correlation function between input and residuals from output. In correlation function of residuals (output) graph, x-axis refers to lag, which is the time difference (in data) between the signals at which the correlation is estimated, while y-axis refers to autocorrelation function (ACF). Two horizontal lines on the plot denote the confidence interval of the corresponding estimates. Fluctuations within confidence interval are considered to be irrelevant. If the residual correlation functions are within the confidence interval, it indicates that the residuals are uncorrelated and it is a good model. The bottom graph shows the cross-correlation of the residuals with the input. A model will be categorized as good if the residuals uncorrelated with previous inputs (independence test). In Figure 5, 6 and 7, OE model has 13 points outside the confidence interval where else ARMAX has 13 and ARX has 5 points. In cross correlation plot, all the data points are within the confidence interval.

As the order increased to three, all the models give better fitting compared to second order. The highest percentage of fitting is shown by OE model (97.04%) followed by ARMAX and ARX. Bode plot shows the same result as second order, where else, step response displays SOPTD lines are overlies on true system line but

FOPTD lines are deviated. It can be clearly seen that, as the model order increases, the model response get better.

The fitting for all the models decreased when the order increased from 3 to 4 and it eventually started to increase again except for OE model when the order changed to 5. The fluctuation happens due to consistency problem. If the process does not come across the noise assumption made by the models, the parameters will be estimated biased and inconsistent. Bias defines the deviation of the parameters systematically from optimal values and it will be either under or over estimated. Inconsistency means that the bias doesn't approach zero even though the number of samples reach infinity.

In sixth order, the model fitting was good but step response plot doesn't show a good response since SOPTD lines are over damped where as FOPTD lines are diverged from true system.

As a conclusion, it can be said that as the model order increases, the fitting gets better but, the response of bode plot and step response are not good compared to the lower order. The optimal order for this system is third order since it gives good model fitting, better response of Bode plot, step response and residual plot. On top of that, OE model gives the better result. The selection of input signal also plays a role in this case. Step, rectangular, PRBS, and sine wave input signals are tested. The better result is given by PRBS signal. The power of noise is inversely proportional to signal to noise ratio (SNR). So, at low noise power, the SNR is high.

The second system used is second order system plus time delay model (SOPTD);

$$\text{System, } g(s) = \frac{1}{(s+0.1)(s+1)} e^{-2s}$$

2000 data points were used for identification, in which the range is from 1-2000, where else; 1000 points were used for validation purpose (2001-3001). The sampling time is equal to 1. Figure 40 and 41 show the input $u(k)$ and output $y(k)$ which are plotted against time by using PRBS and APRBS excitation signals.

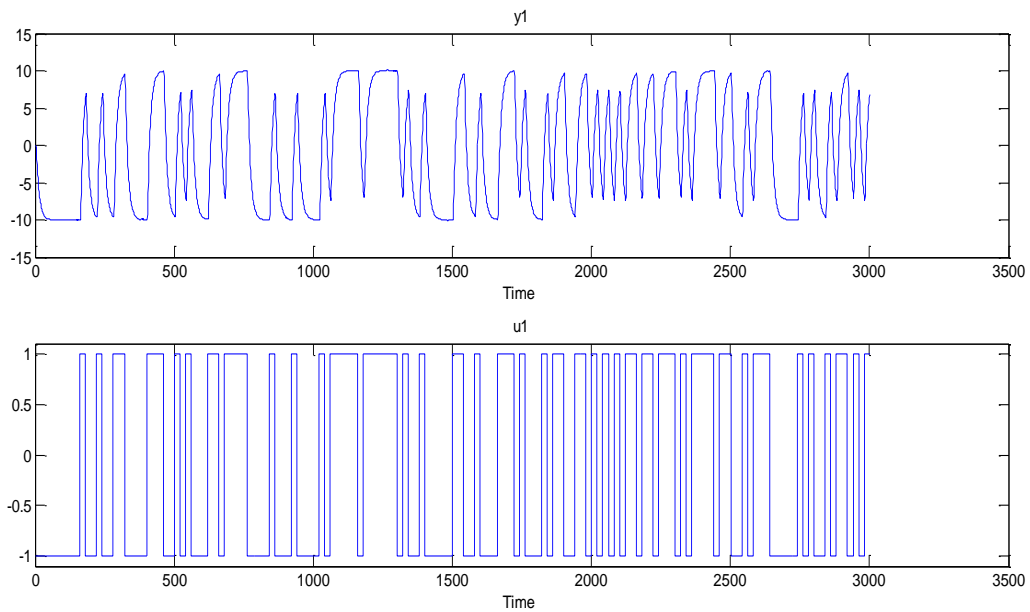

Figure 40: Input, u & Output, y vs. Time (PRBS)

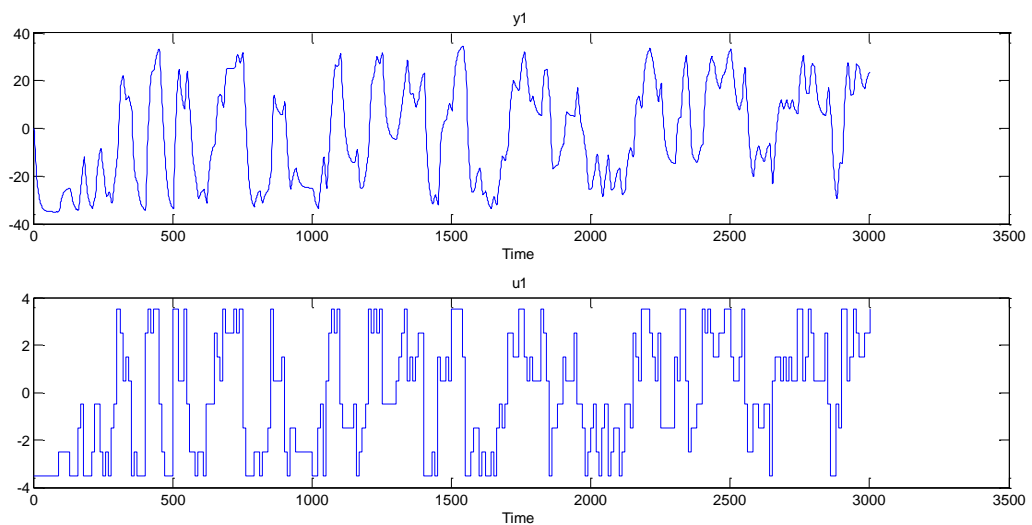

Figure 41: Input, u & Output, y vs. Time (APRBS)

The first 100 measured input and output values are included in Appendix 2.

In this section, the comparison of amplitude modulated PRBS (APRBS) and PRBS excitation signals is discussed. First, the fitting, step response, bode diagram and residual plots are illustrated, that obtained by using PRBS signal. There are five case studies with different orders (first order until fifth order). A SOPTD system is considered in the interval $[-1 \ 1]$ with probability of shift (p) equal to 0.05.

Although a PRBS is well suited for linear system identification, if the one-step prediction function is known to be a plane, it is inappropriate for nonlinear systems. In order to make a general conclusion on the excitation signals, PRBS is compared with APRBS.

Case Study 1 (na:1; nb:1; nc:1) (PRBS)

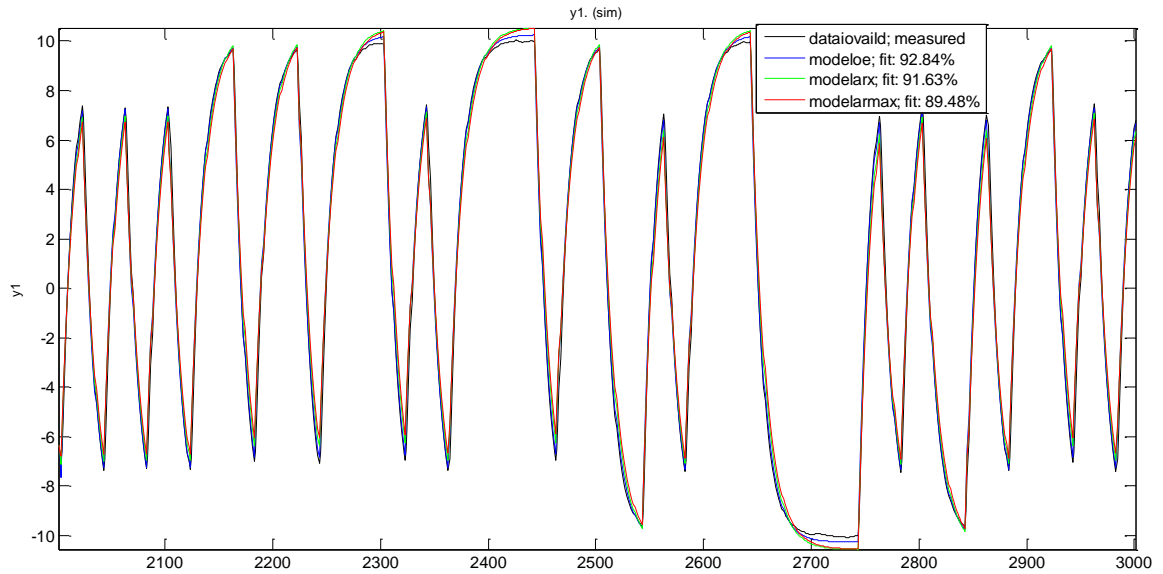

Figure 42: Comparison of model output with the actual measured values (First Order-PRBS)

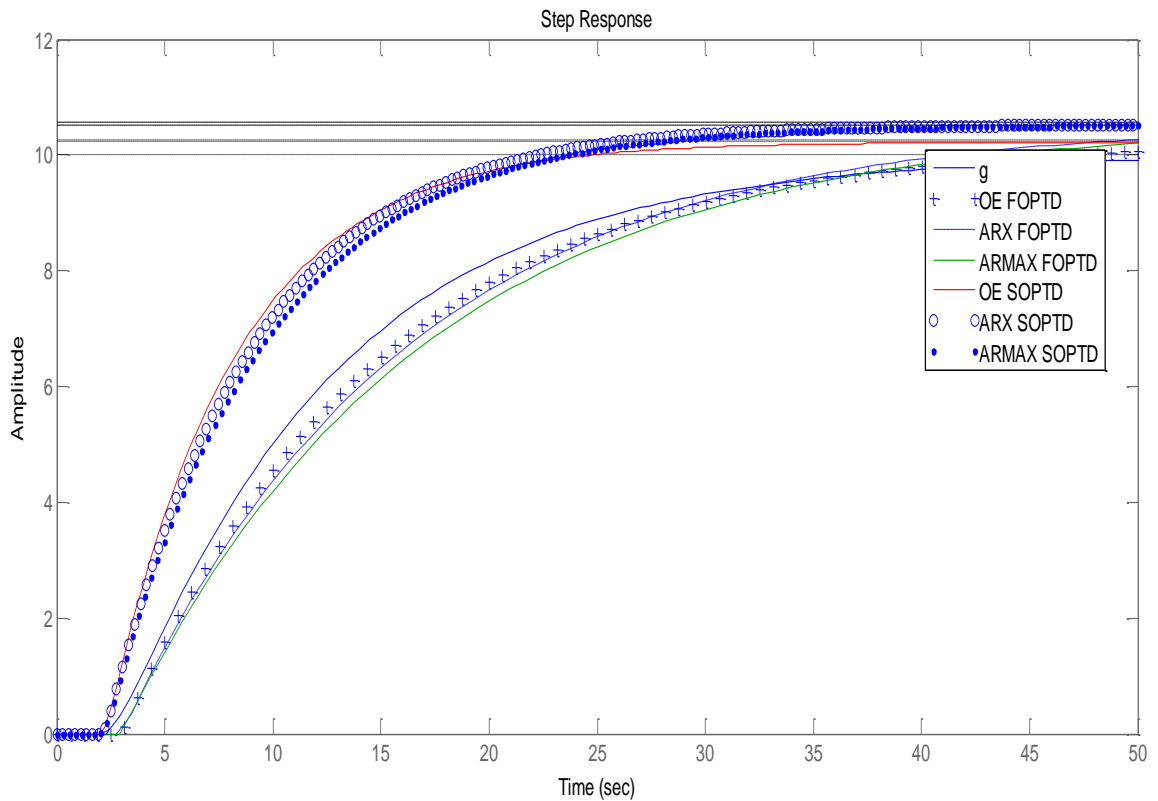

Figure 43: Step response for OE, ARX and ARMAX models (First Order-PRBS)

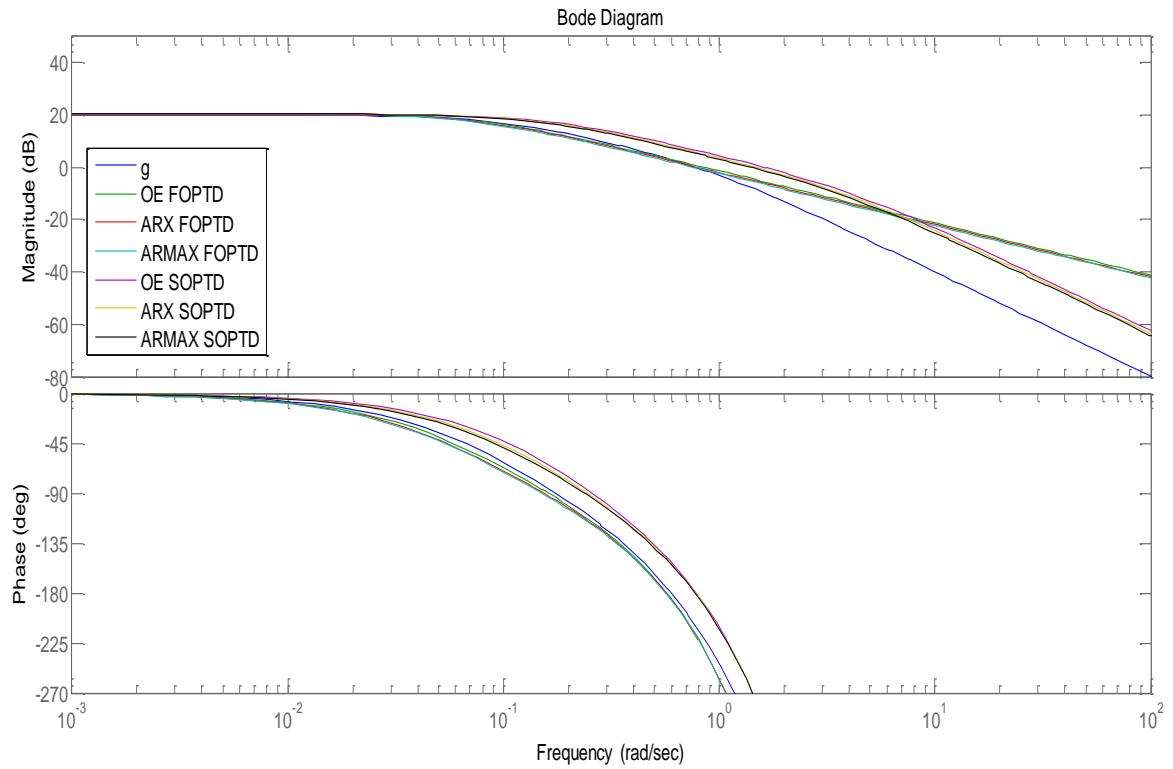

Figure 44: Bode Plot for OE, ARX and ARMAX models (First Order-PRBS)

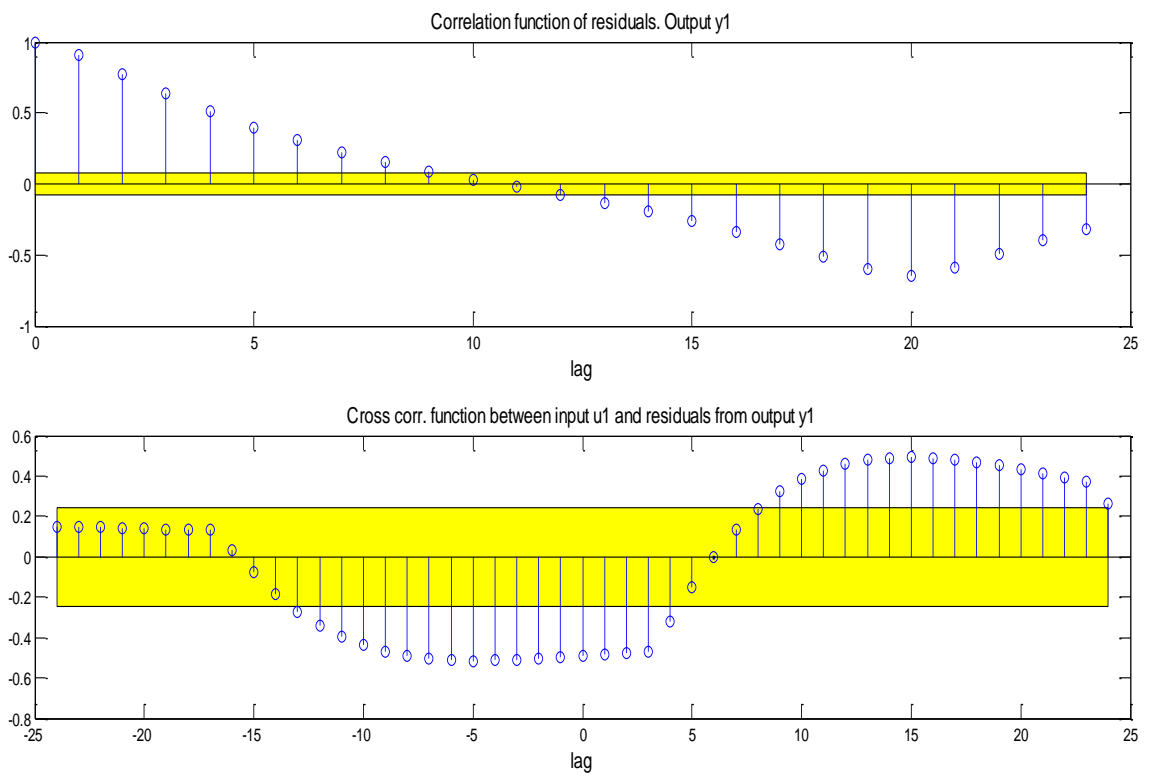

Figure 45: Residual Plot for OE (First Order-PRBS)

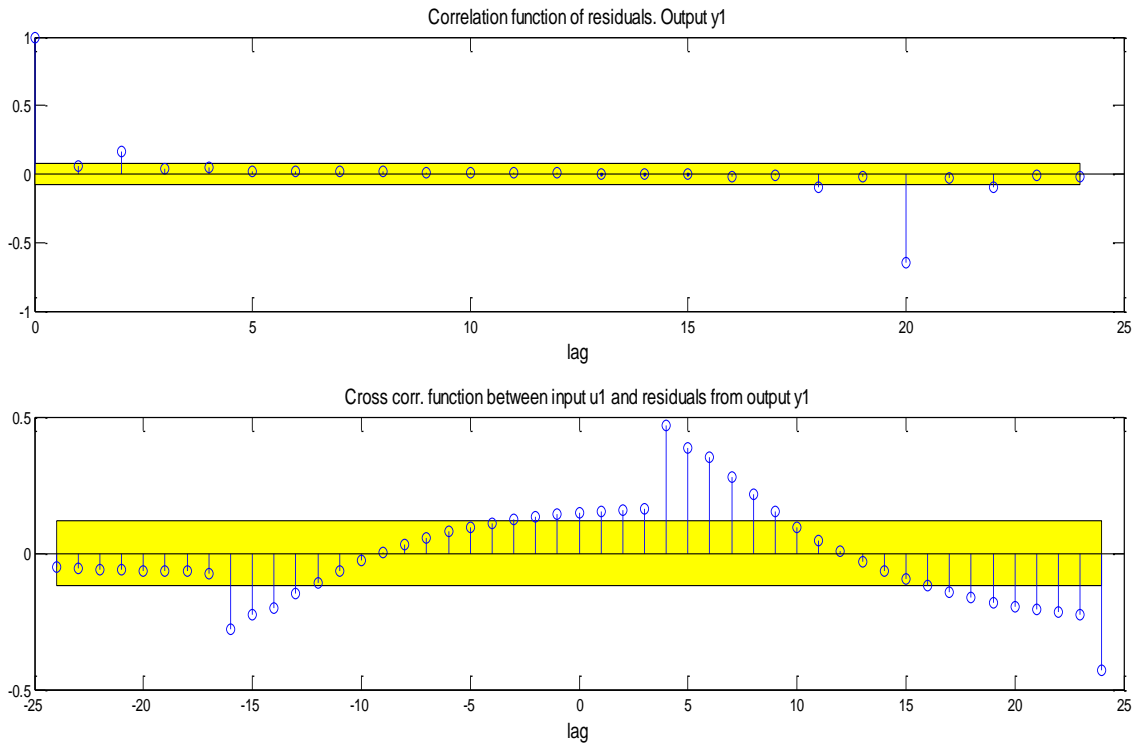

Figure 46: Residual Plot for ARMAX (First Order-PRBS)

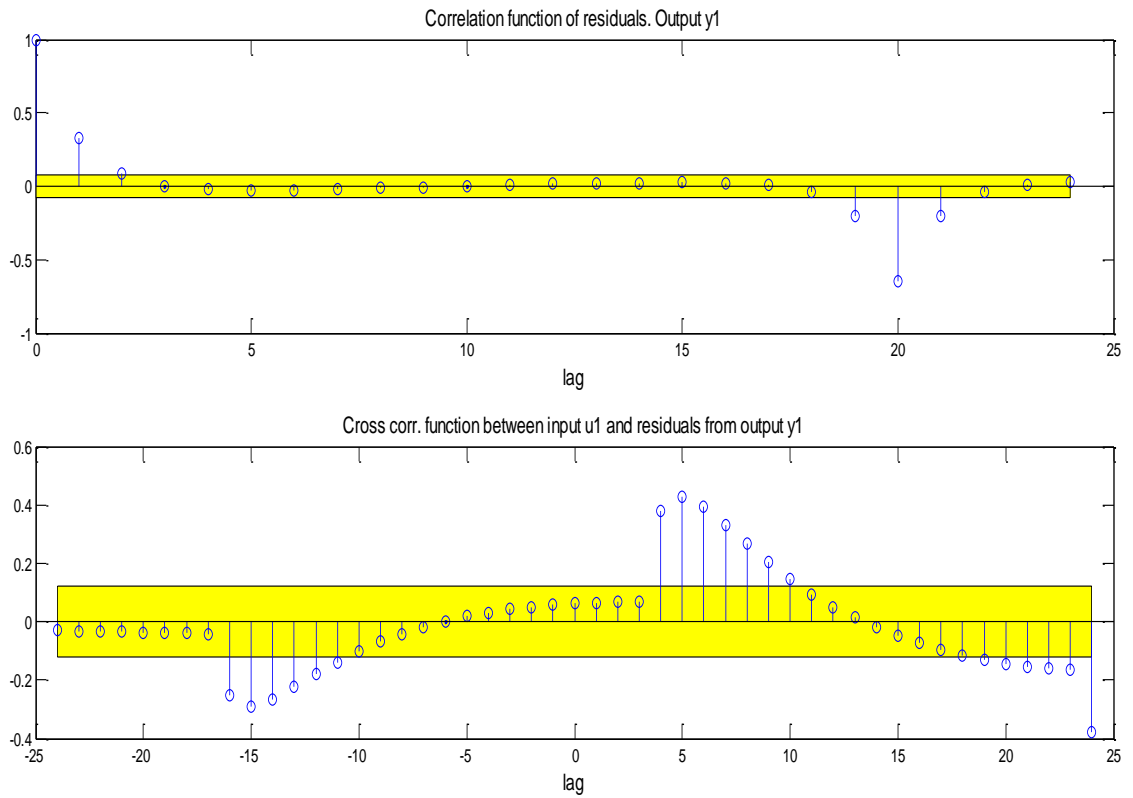

Figure 47: Residual Plot for ARX (First Order-PRBS)

Case Study 2 (na:2; nb:2; nc:2) (PRBS)

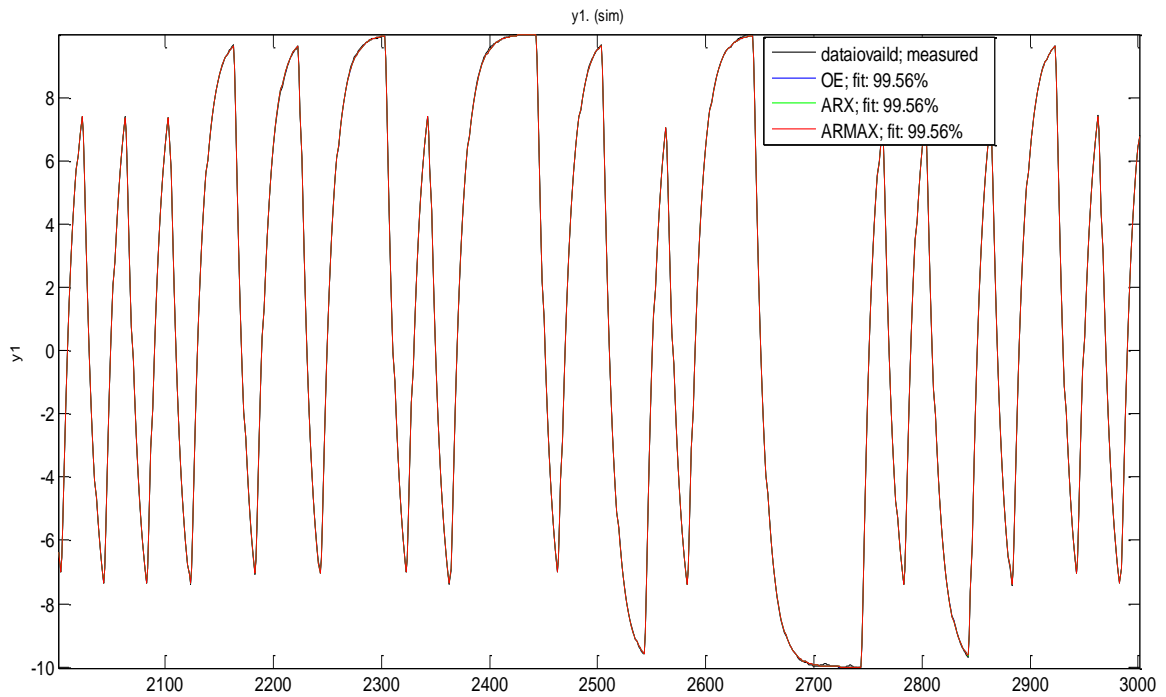

Figure 48: Comparison of model output with the actual measured values (Second Order-PRBS)

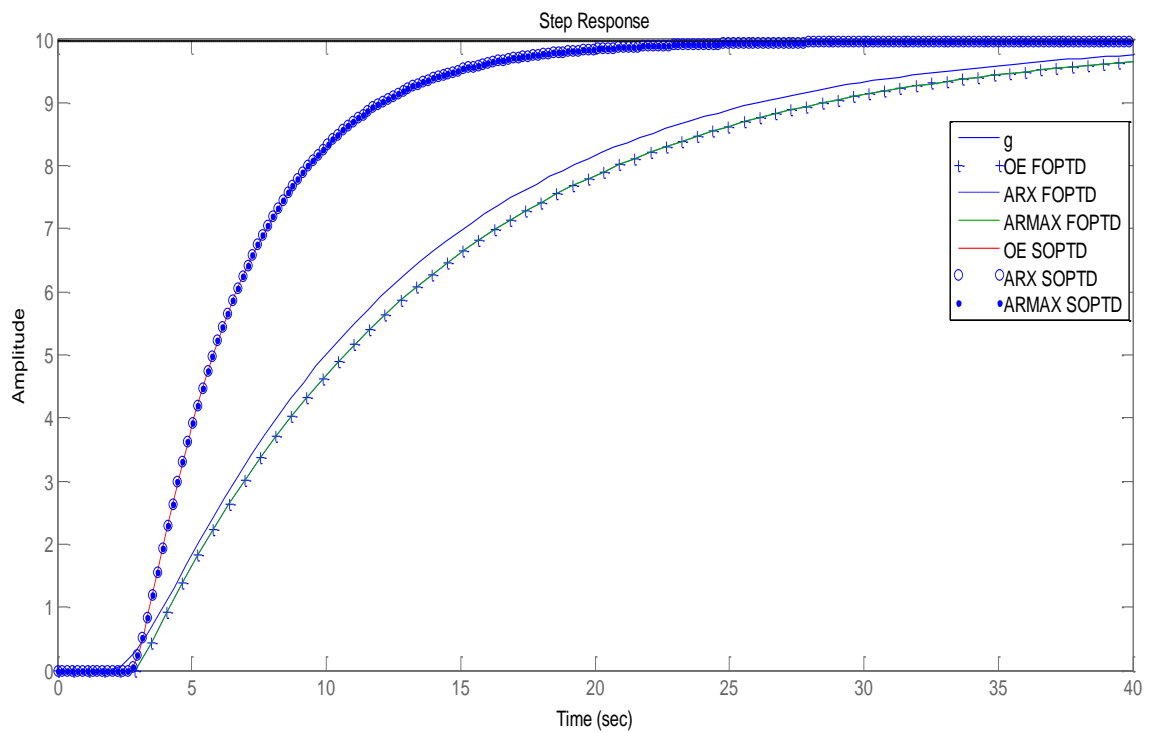

Figure 49: Step response for OE, ARX and ARMAX models (Second Order-PRBS)

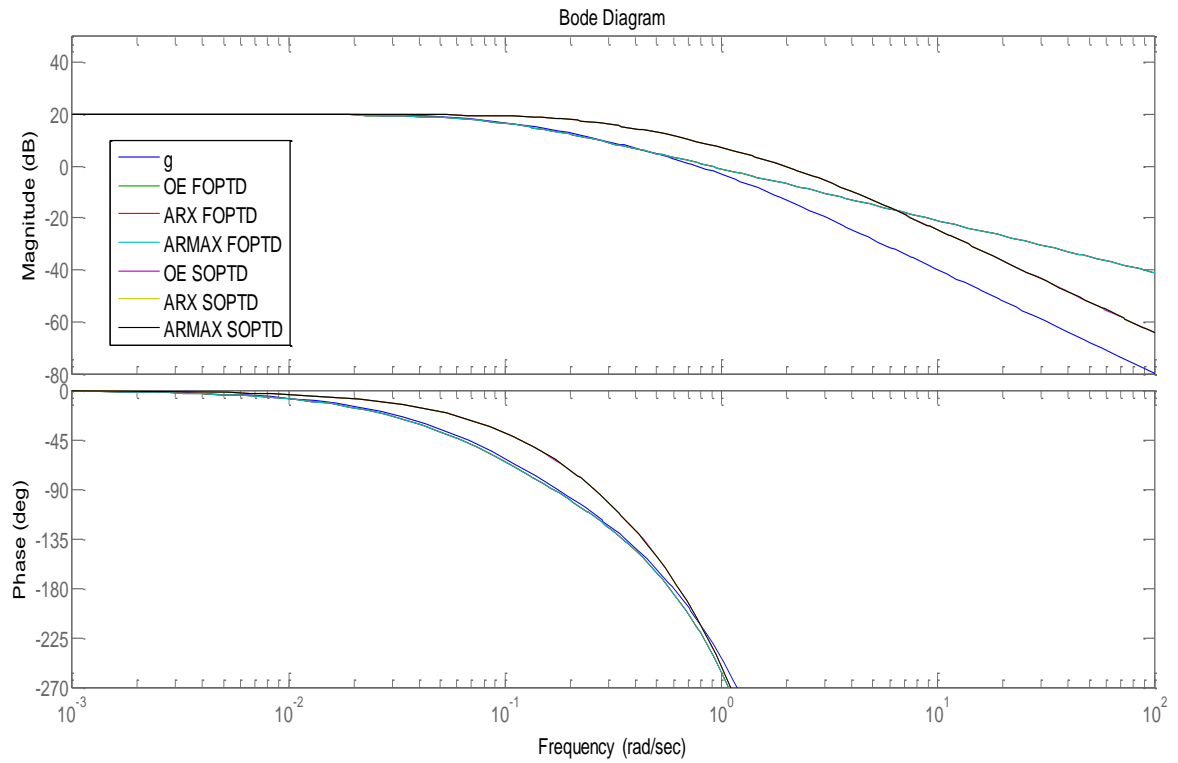

Figure 50: Bode Plot for OE, ARX and ARMAX models (Second Order-PRBS)

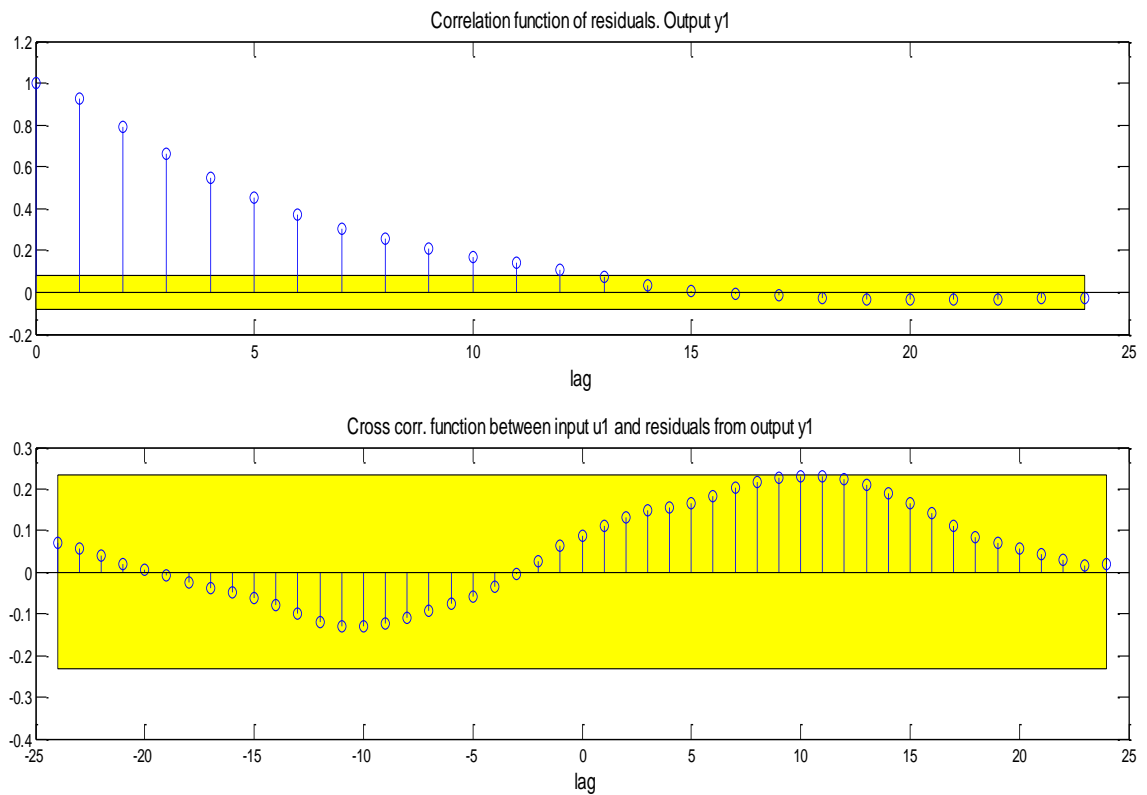

Figure 51: Residual Plot for OE (Second Order-PRBS)

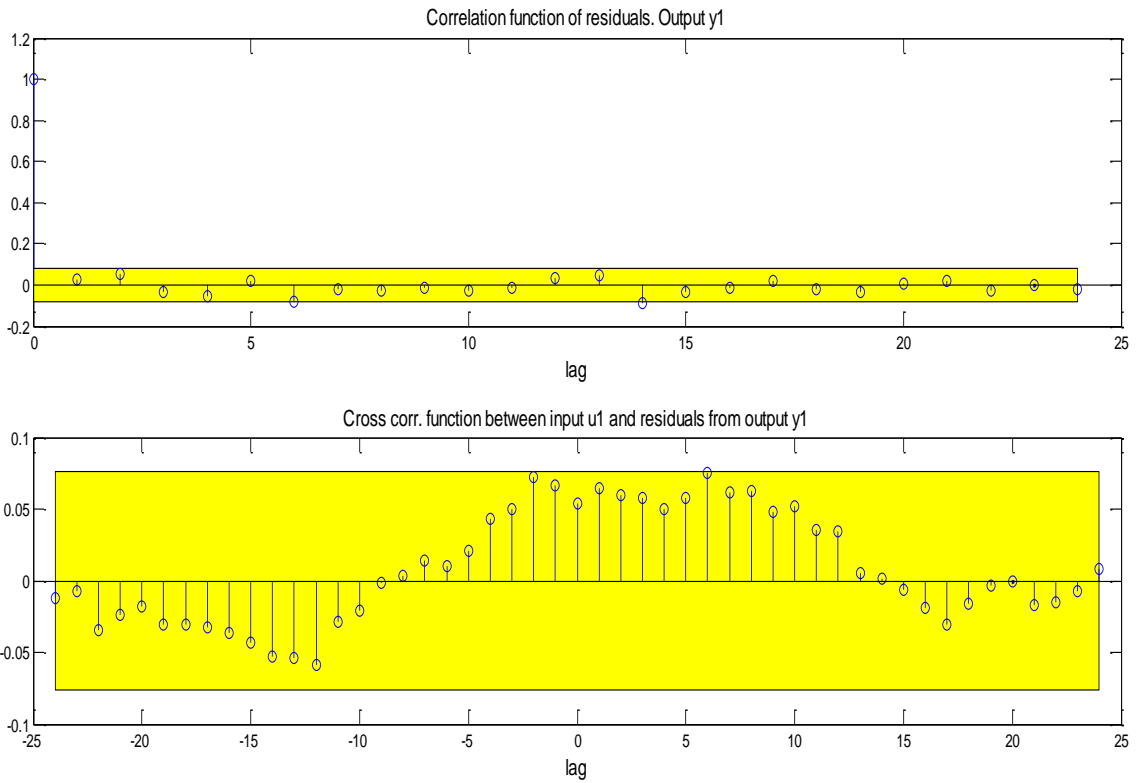

Figure 52: Residual Plot for ARMAX (Second Order-PRBS)

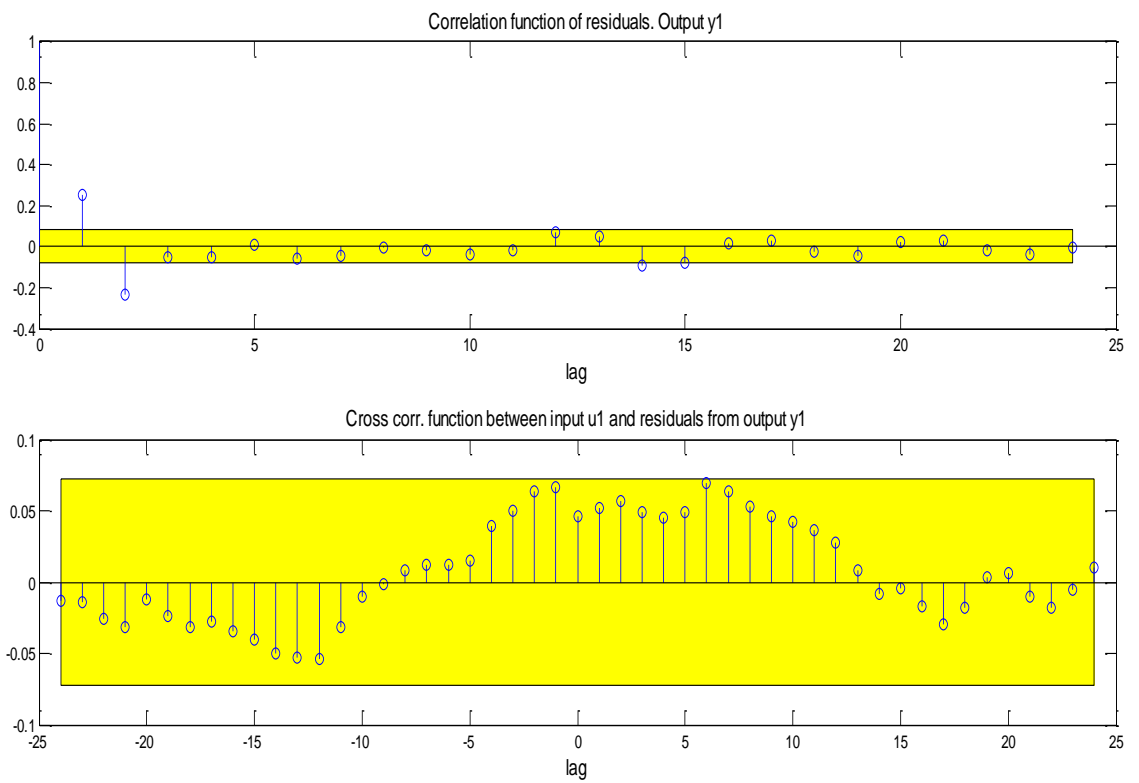

Figure 53: Residual Plot for ARX (Second Order-PRBS)

Case Study 3 (na:3; nb:3; nc:3) (PRBS)

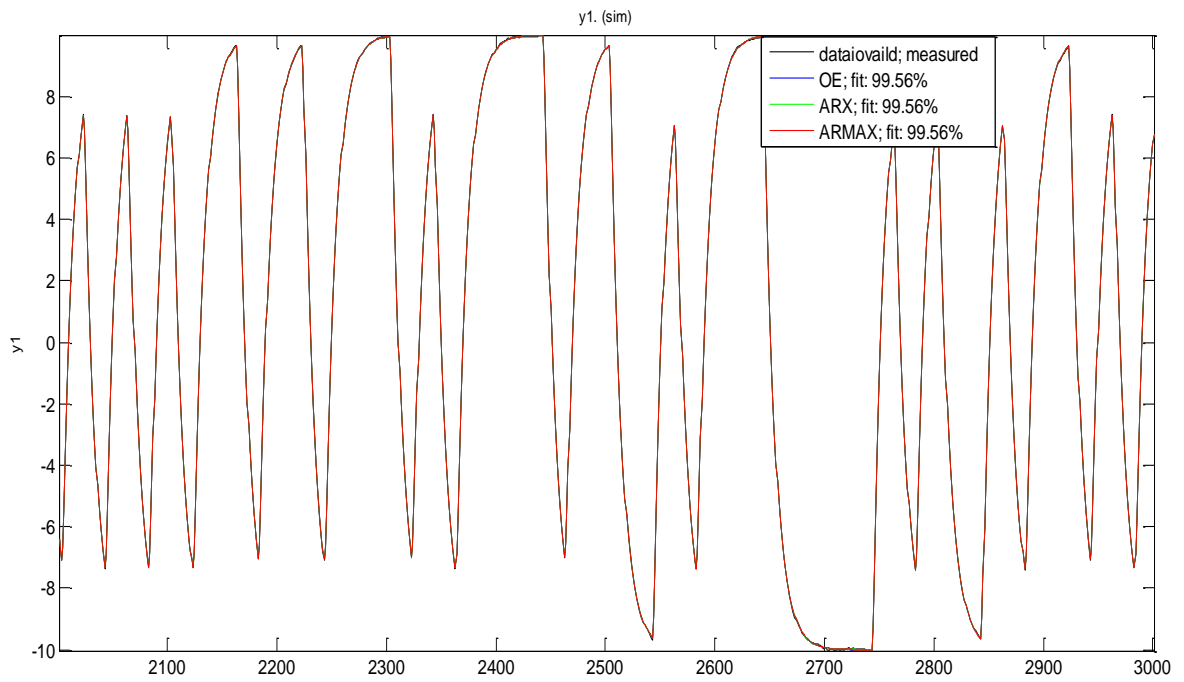

Figure 54: Comparison of model output with the actual measured values (Third Order-PRBS)

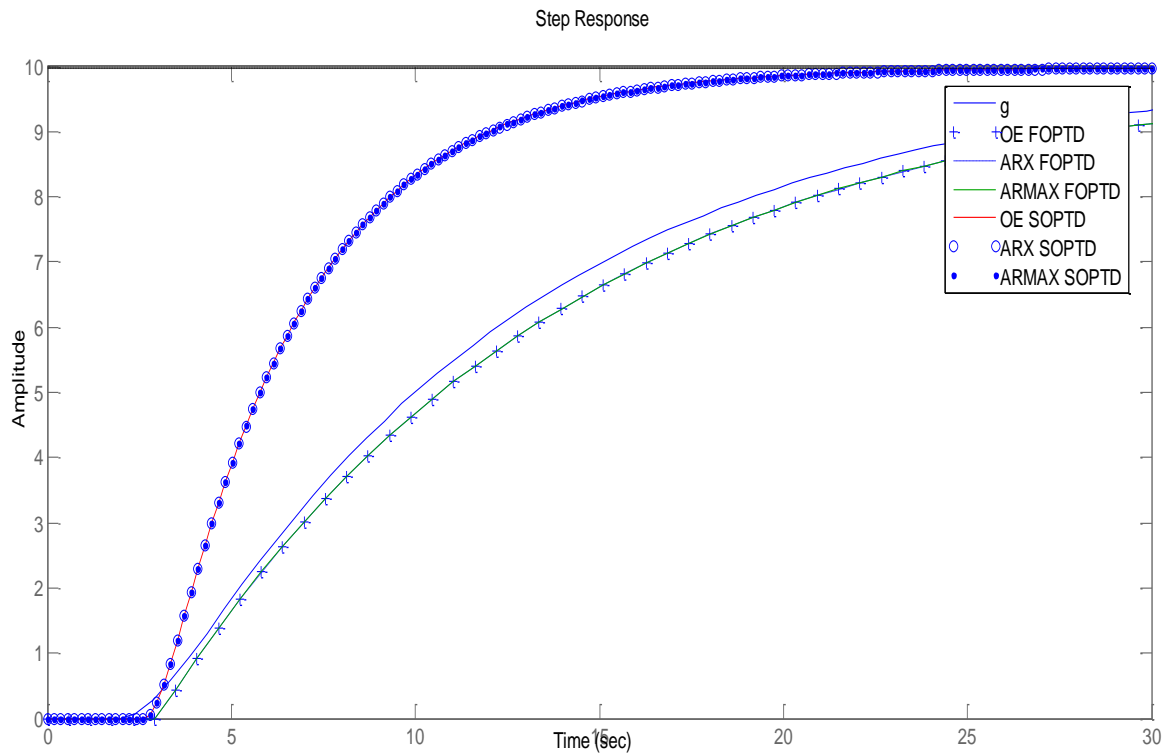

Figure 55: Step response for OE, ARX and ARMAX models (Third Order-PRBS)

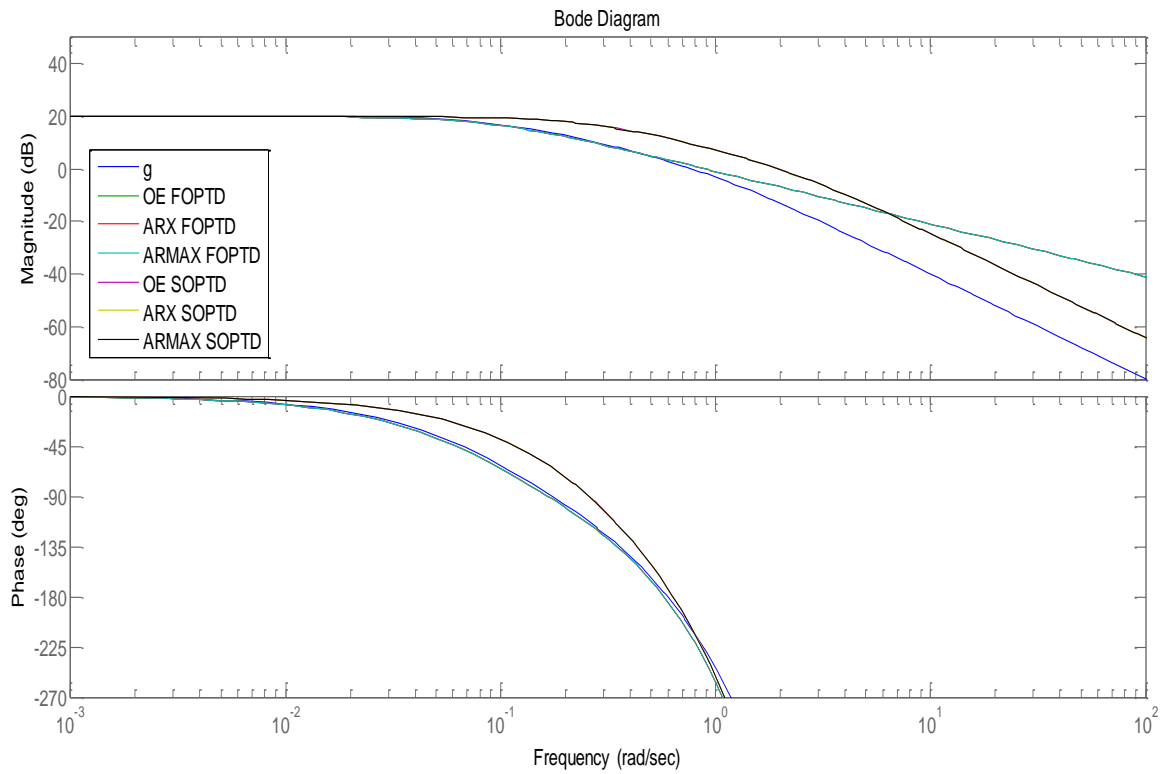

Figure 56: Bode Plot for OE, ARX and ARMAX models (Third Order-PRBS)

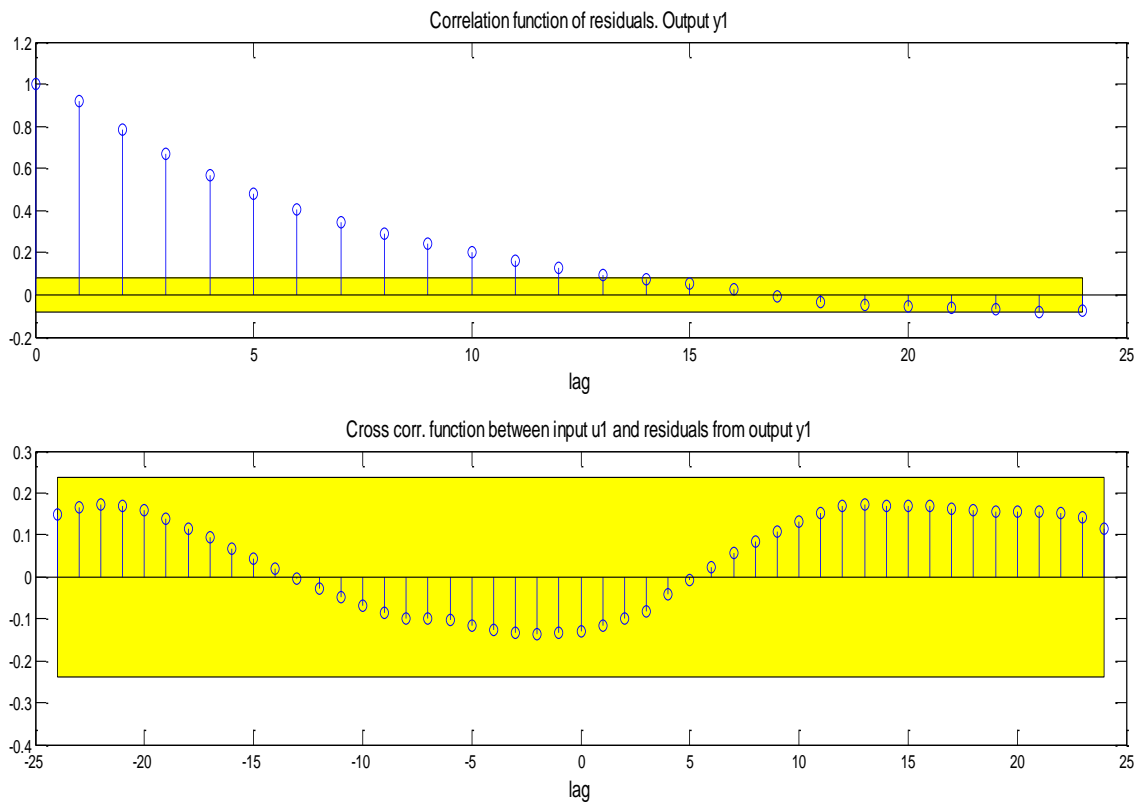

Figure 57: Residual Plot for OE (Third Order-PRBS)

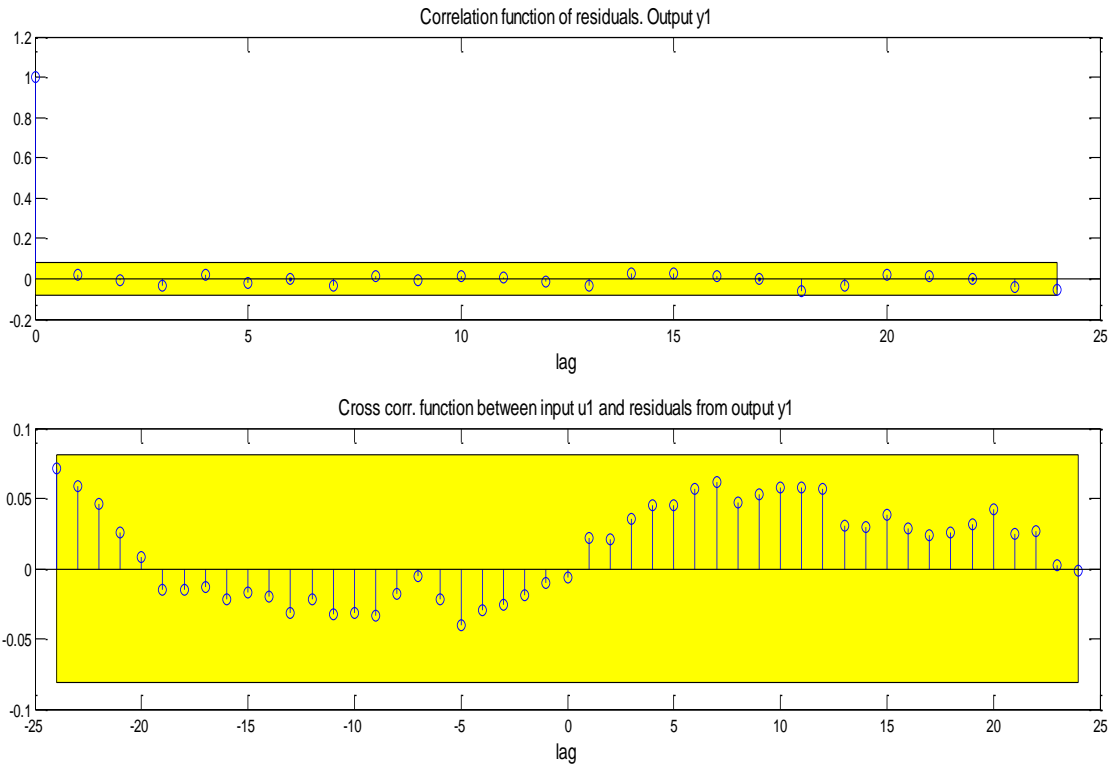

Figure 58: Residual Plot for ARMAX (Third Order-PRBS)

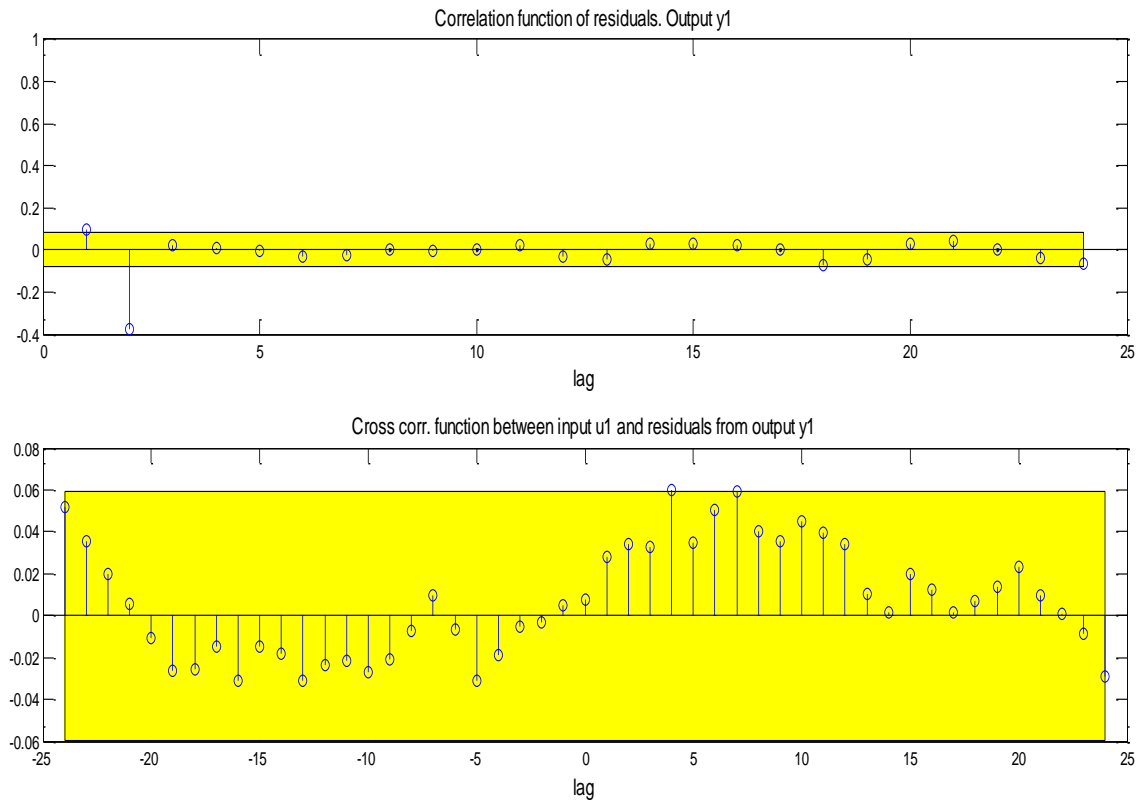

Figure 59: Residual Plot for ARMAX (Third Order-PRBS)

Case Study 4 (na:4; nb:4; nc:4) (PRBS)

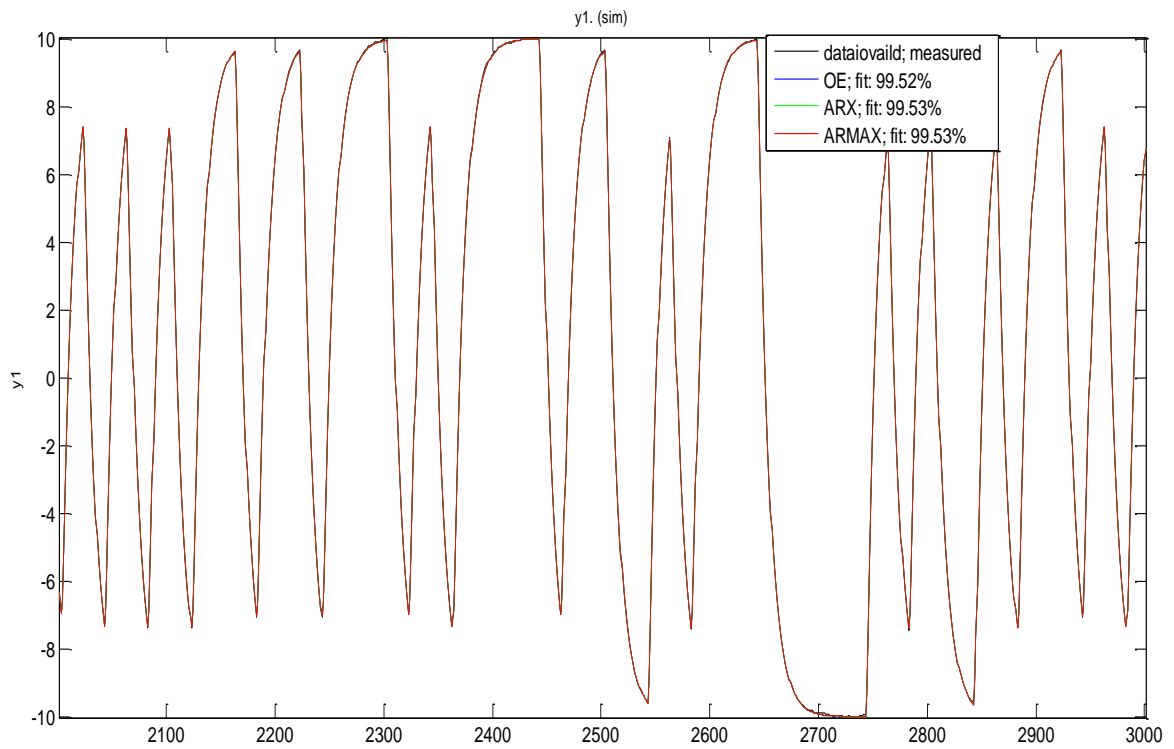

Figure 60: Comparison of model output with the actual measured values (Fourth Order-PRBS)

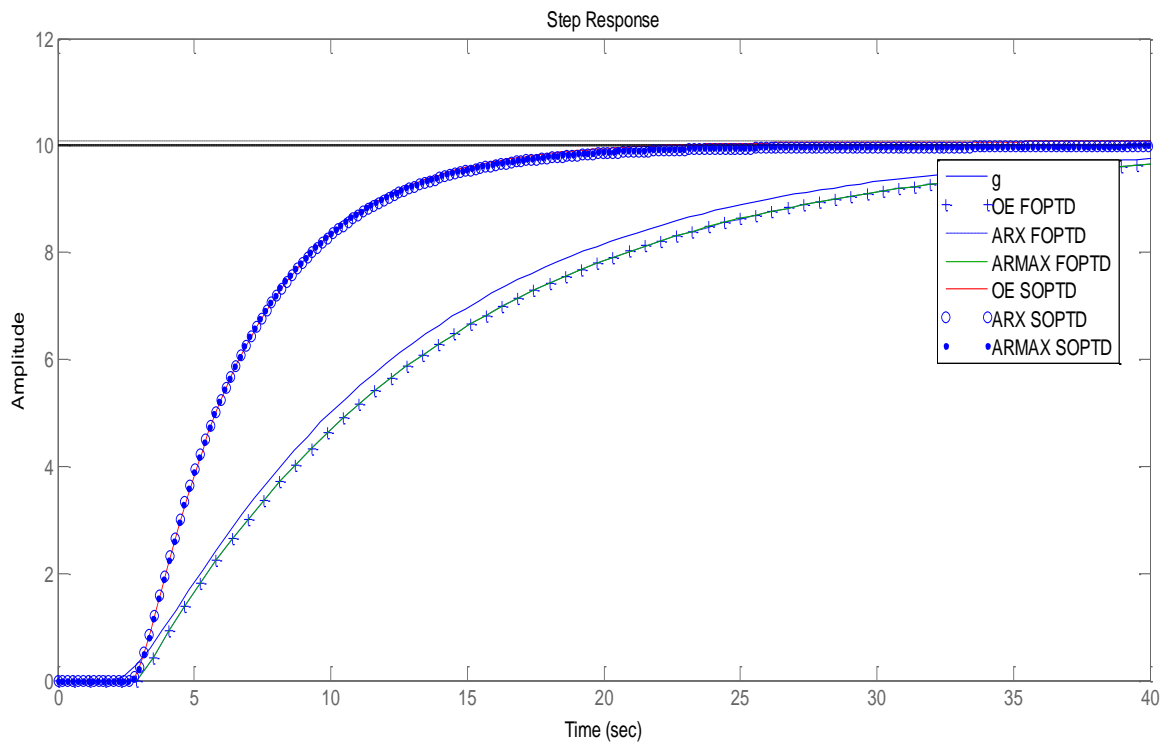

Figure 61: Step response for OE, ARX and ARMAX models (Fourth Order-PRBS)

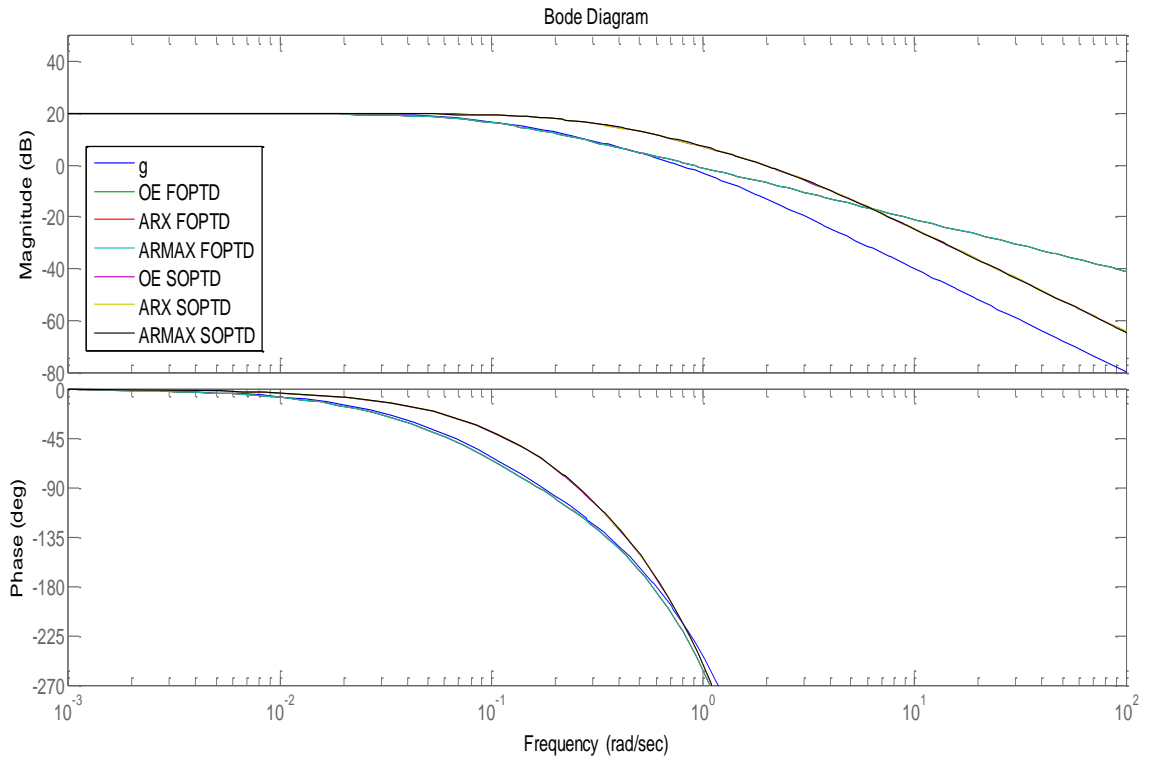

Figure 62: Bode Plot for OE, ARX and ARMAX models (Fourth Order-PRBS)

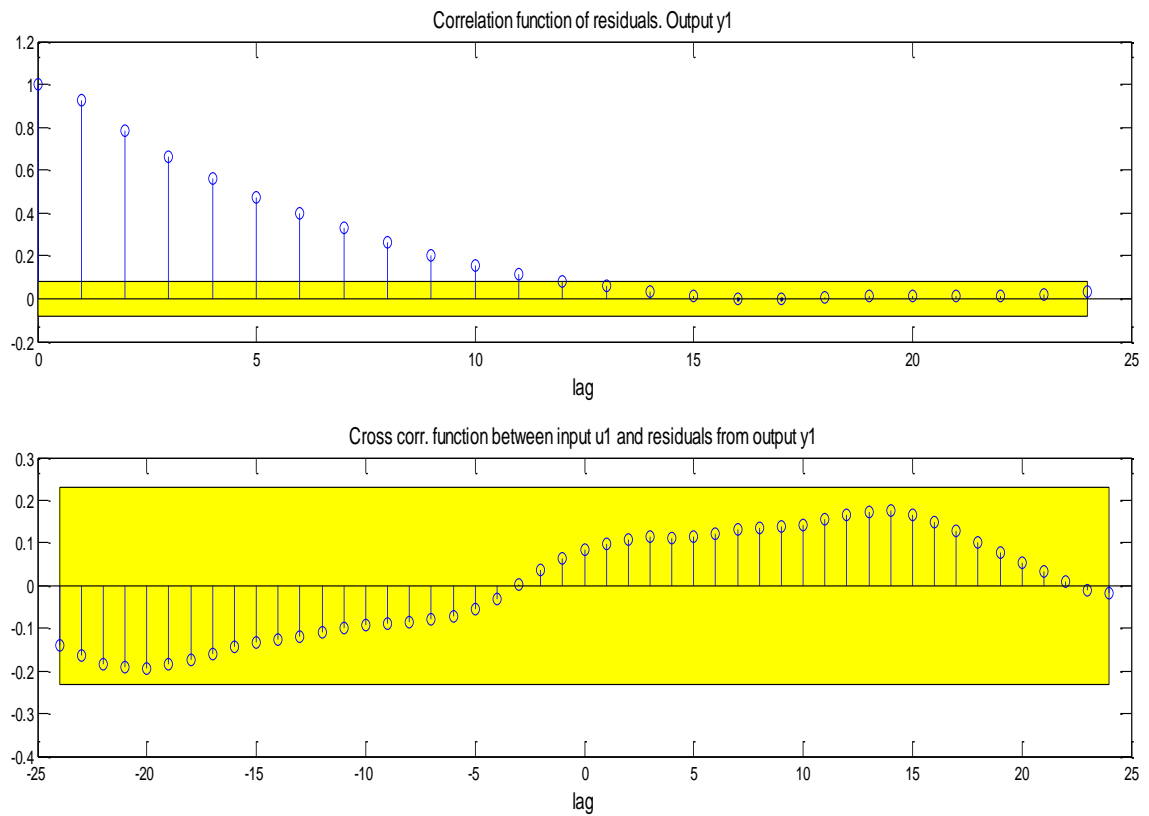

Figure 63: Residual Plot for OE (Fourth Order-PRBS)

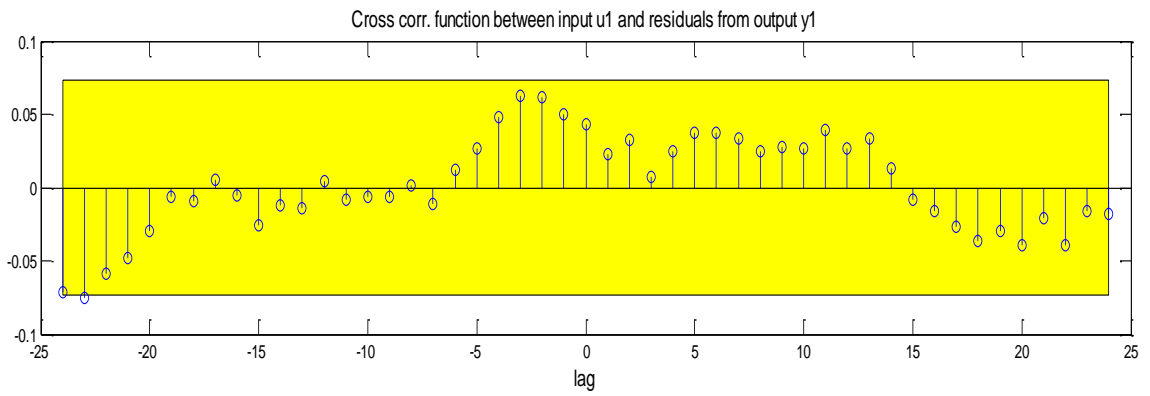
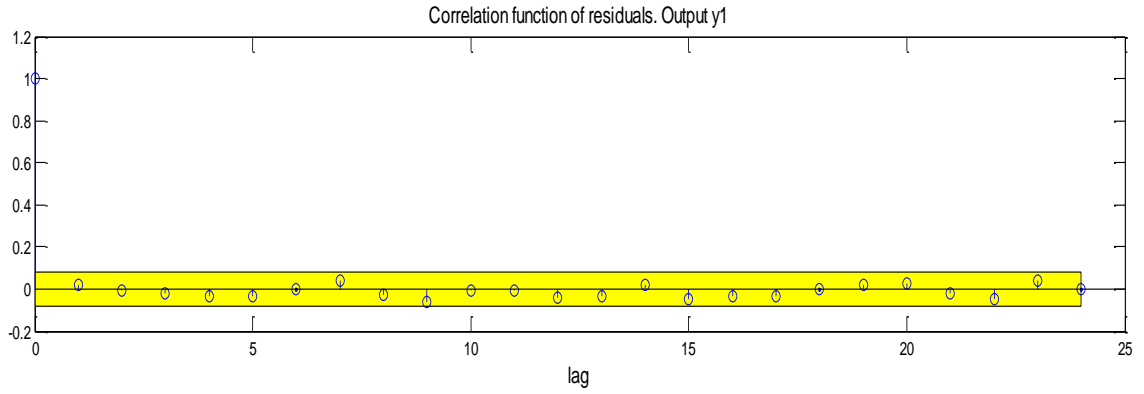

Figure 64: Residual Plot for ARMAX (Fourth Order-PRBS)

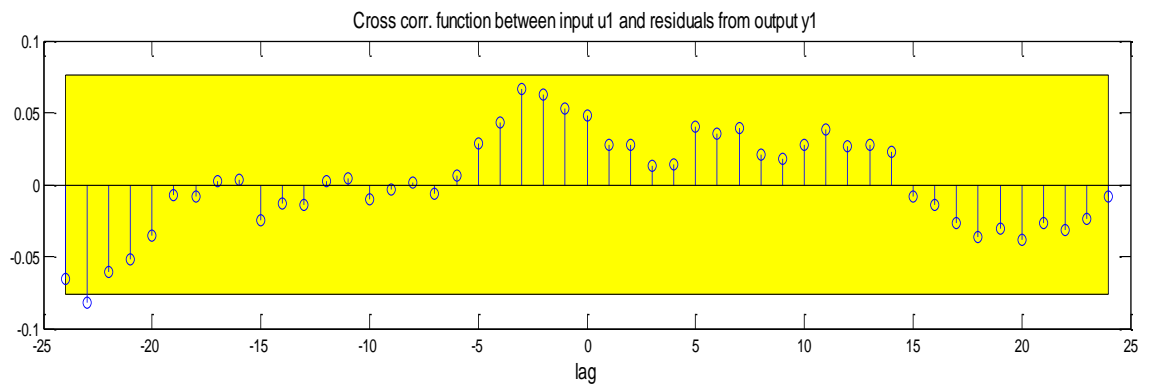
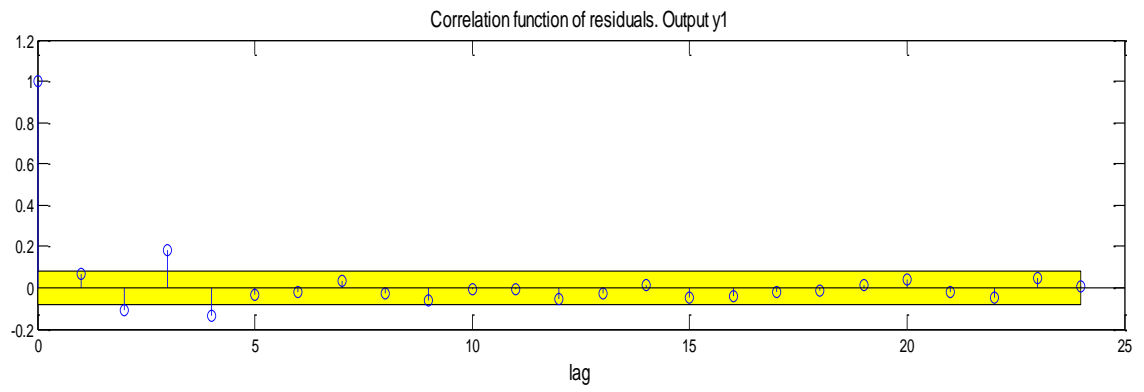

Figure 65: Residual Plot for ARX (Fourth Order-PRBS)

Case Study 5 (na:5; nb:5; nc:5) (PRBS)

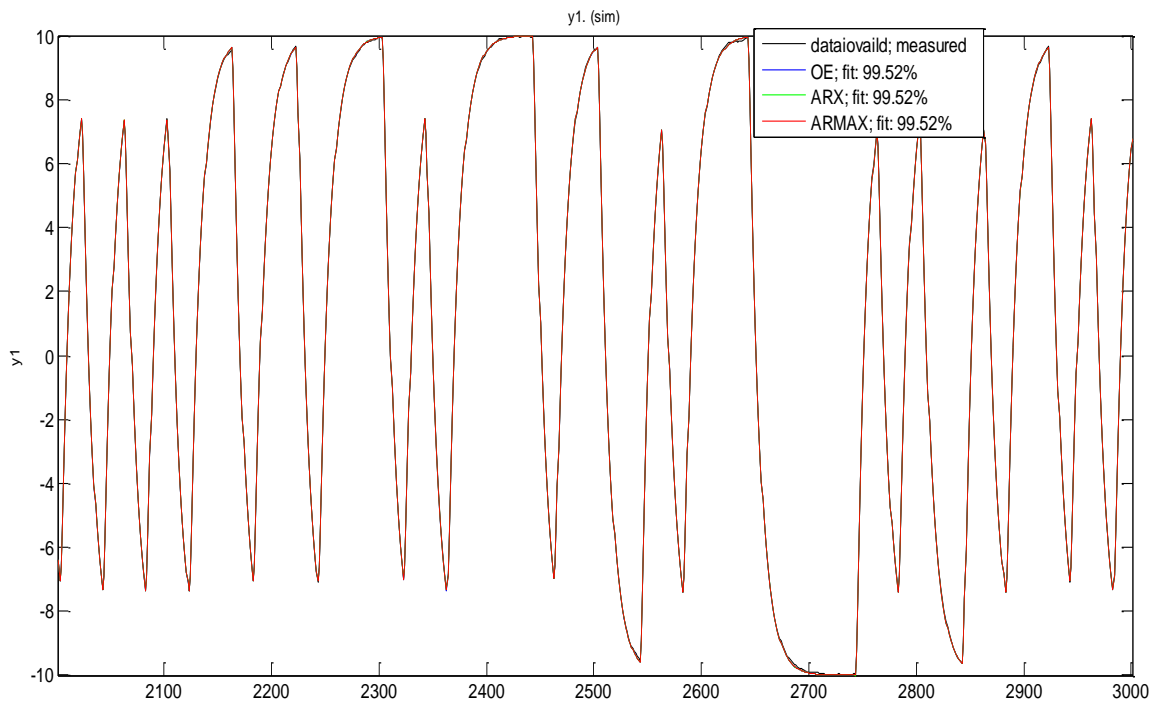

Figure 66: Comparison of model output with the actual measured values (Fourth Order-PRBS)

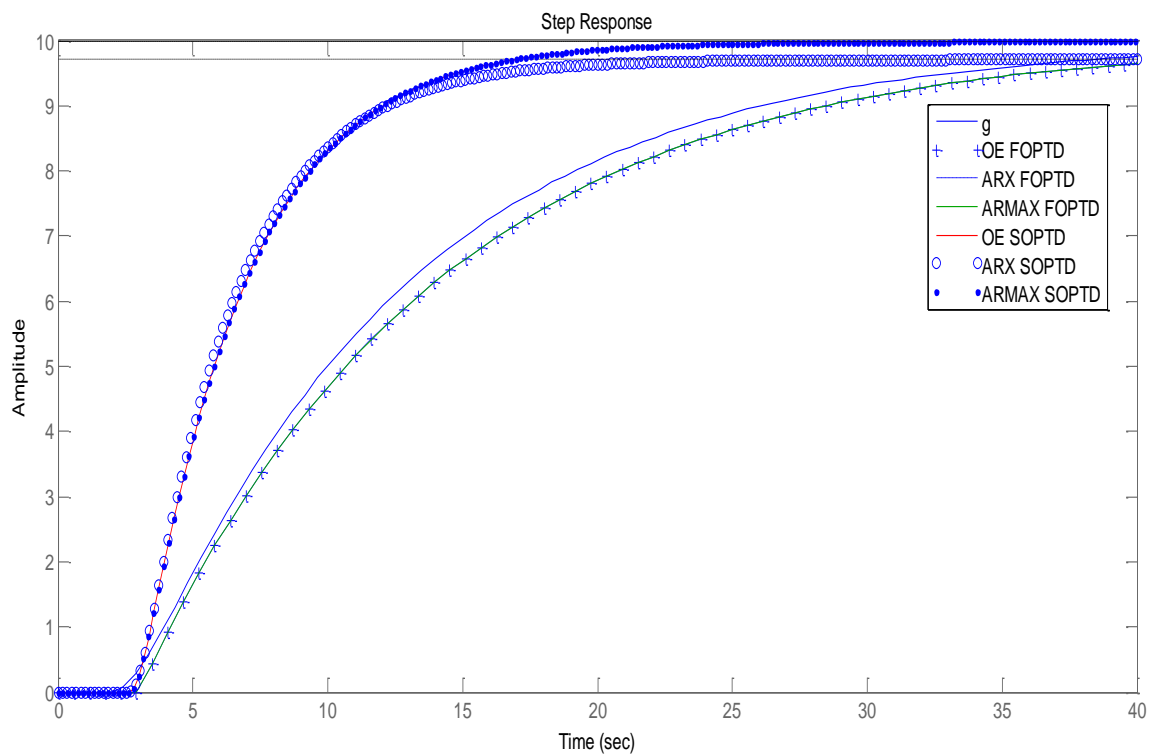

Figure 67: Step response for OE, ARX and ARMAX models (Fifth Order-PRBS)

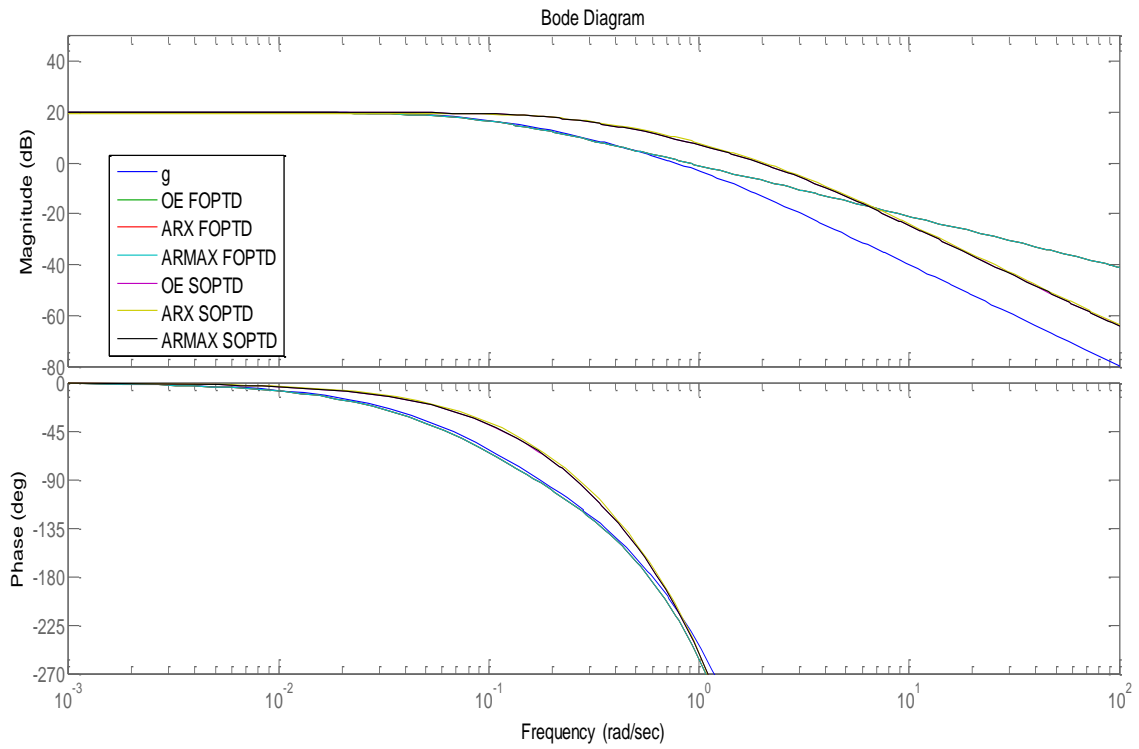

Figure 68: Bode Plot for OE, ARX and ARMAX models (Fifth Order-PRBS)

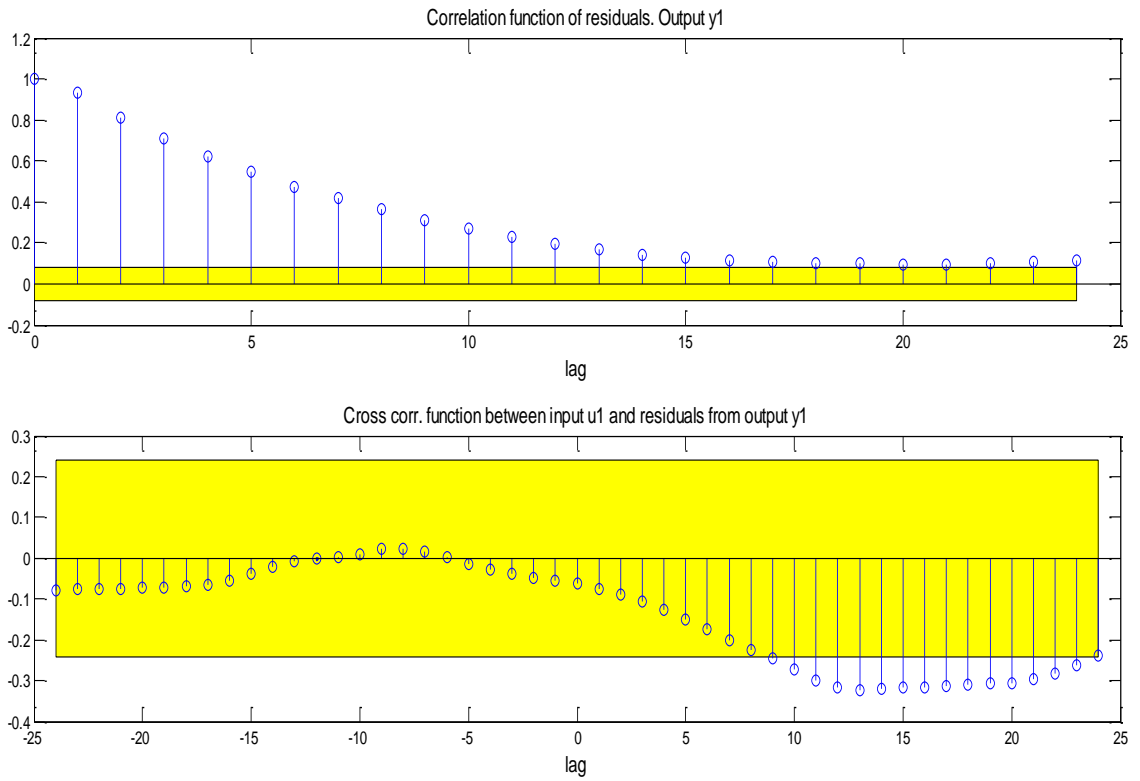

Figure 69: Residual Plot for OE (Fifth Order-PRBS)

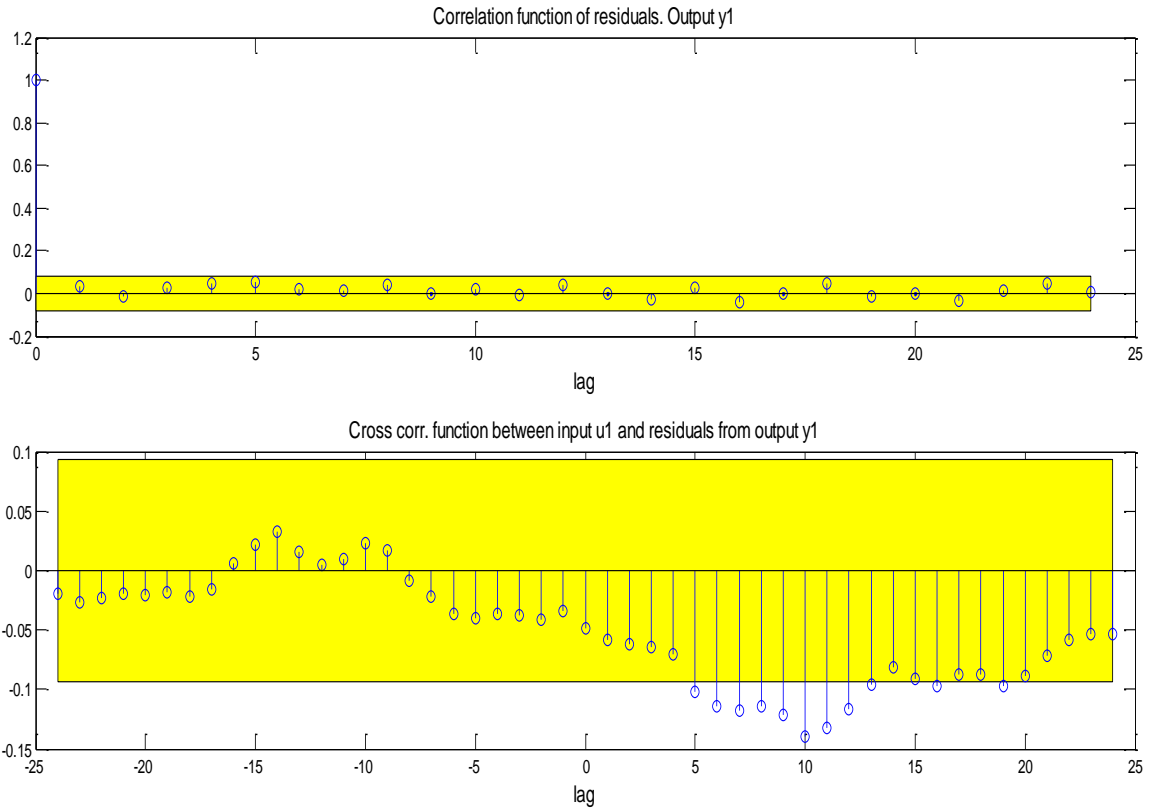

Figure 70: Residual Plot for ARMAX (Fifth Order-PRBS)

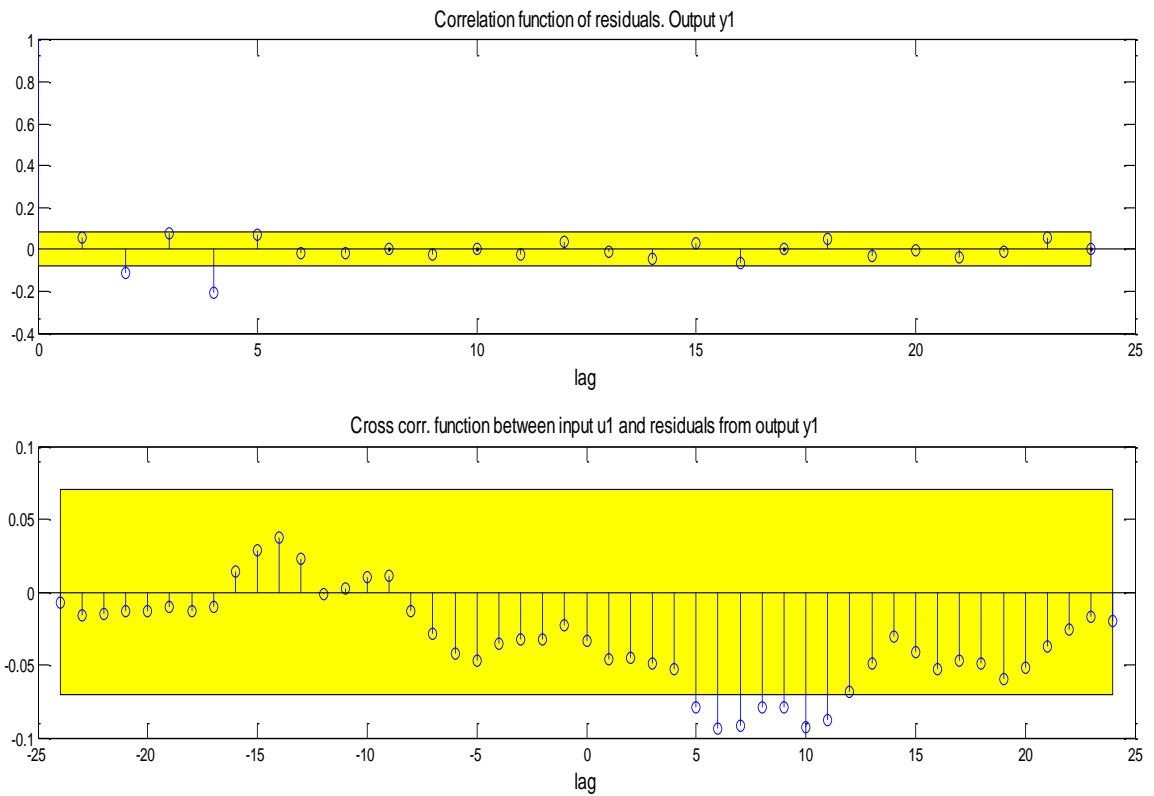

Figure 71: Residual Plot for ARX (Fifth Order-PRBS)

Case Study 1 (na:1; nb:1; nc:1) (APRBS)

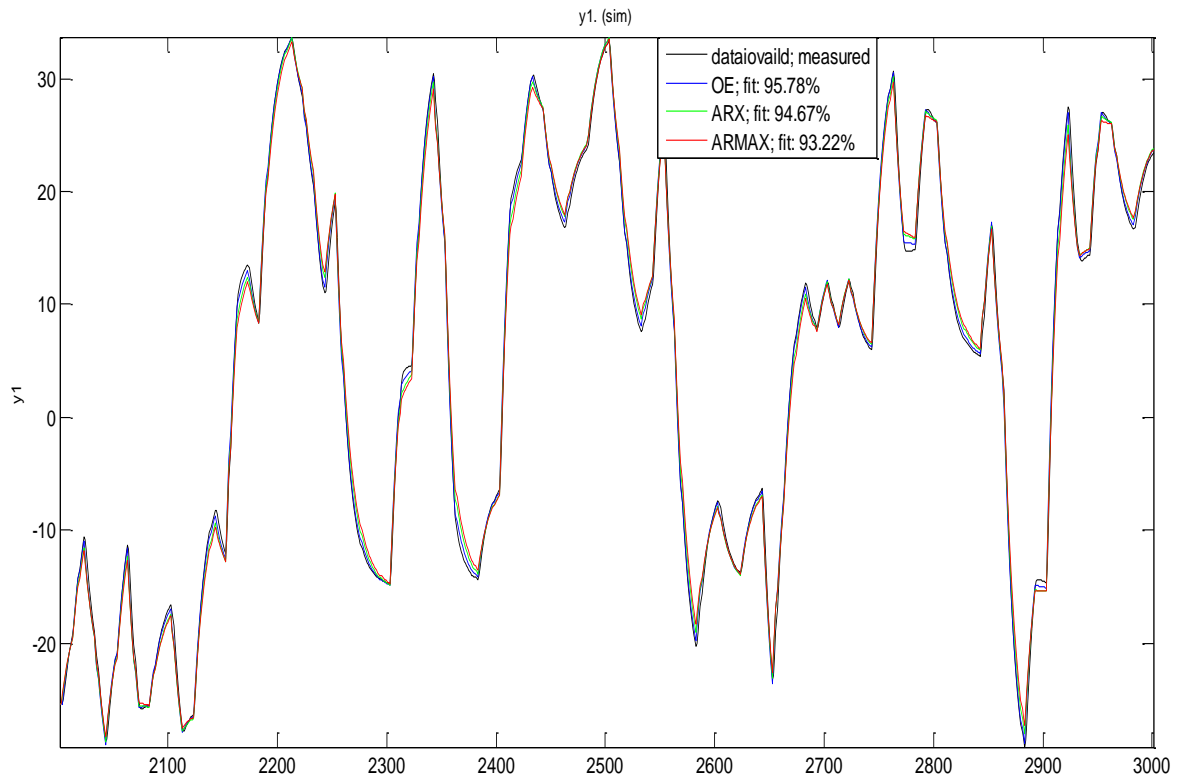

Figure 72: Comparison of model output with the actual measured values (First Order-APRBS)

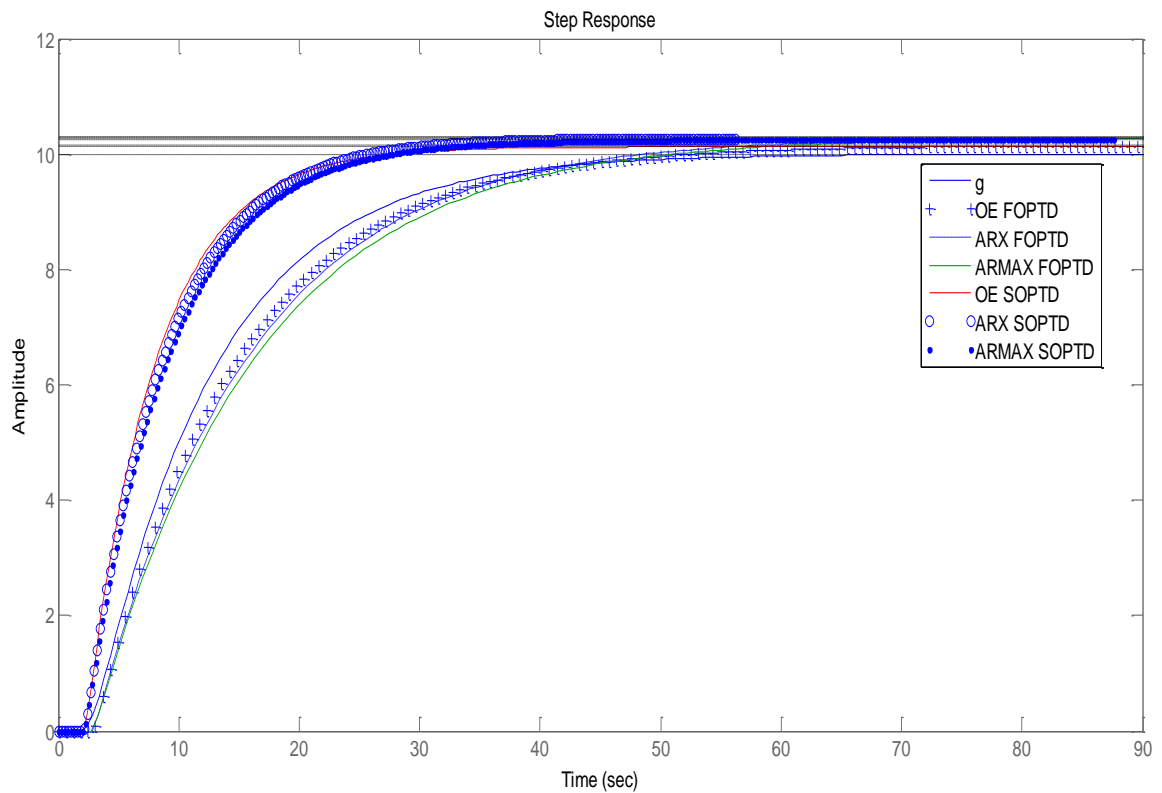

Figure 73: Step response for OE, ARX and ARMAX models (First Order-APRBS)

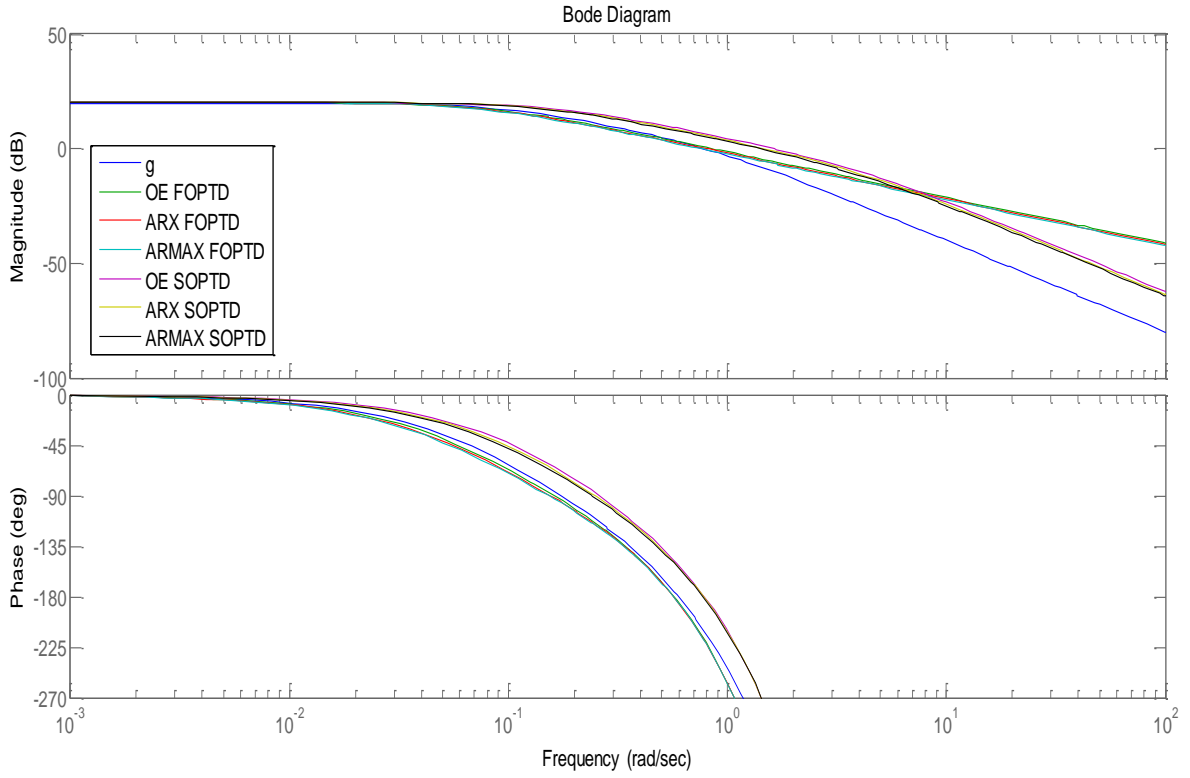

Figure 74: Bode Plot for OE, ARX and ARMAX models (First Order-APRBS)

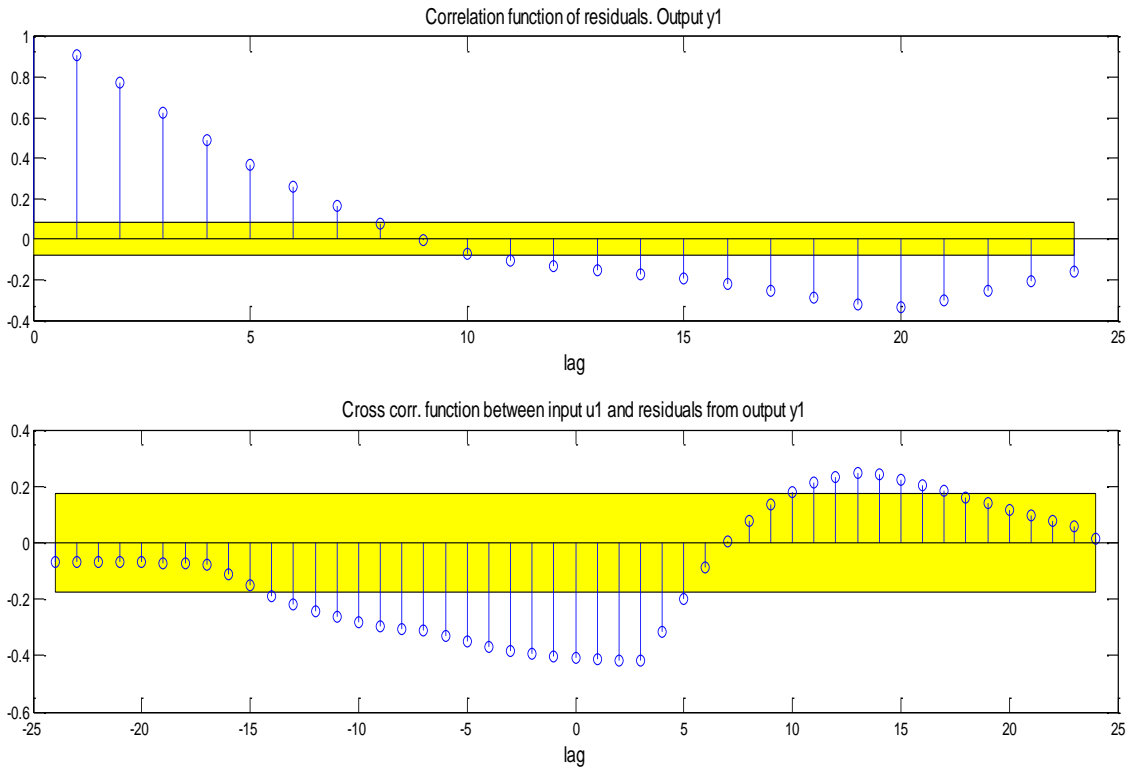

Figure 75: Residual Plot for OE (First Order-APRBS)

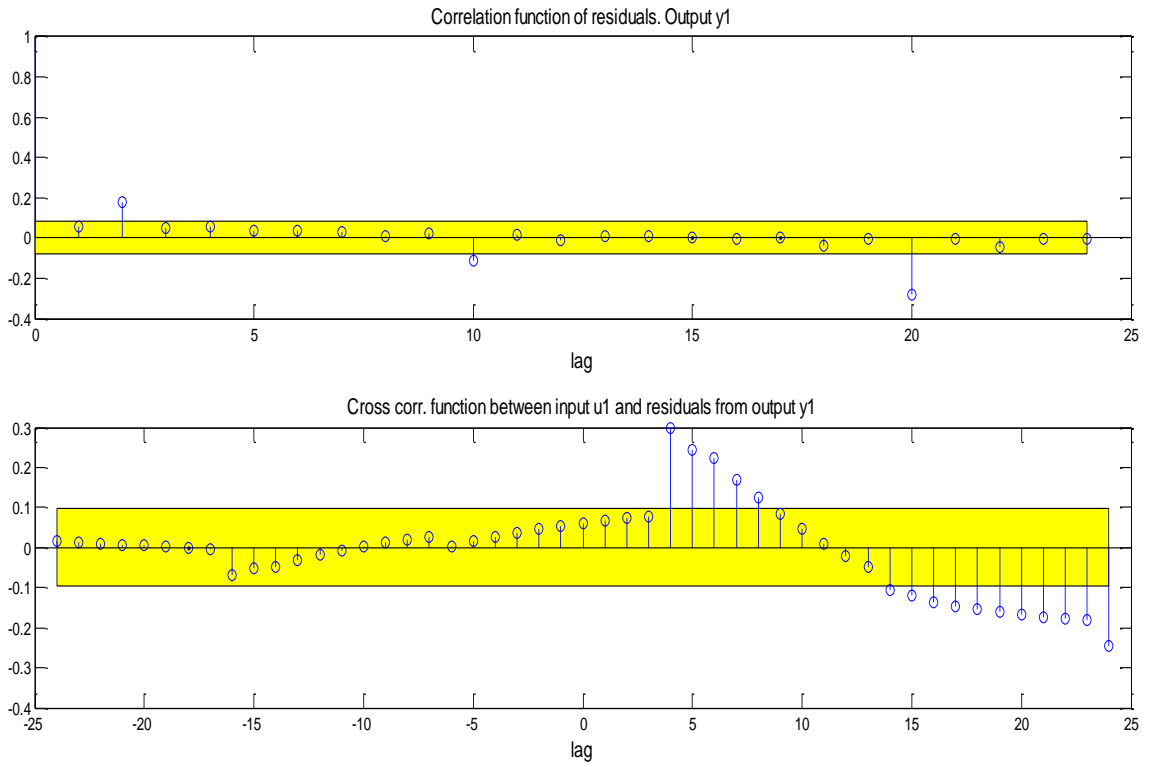

Figure 76: Residual Plot for ARMAX (First Order-APRBS)

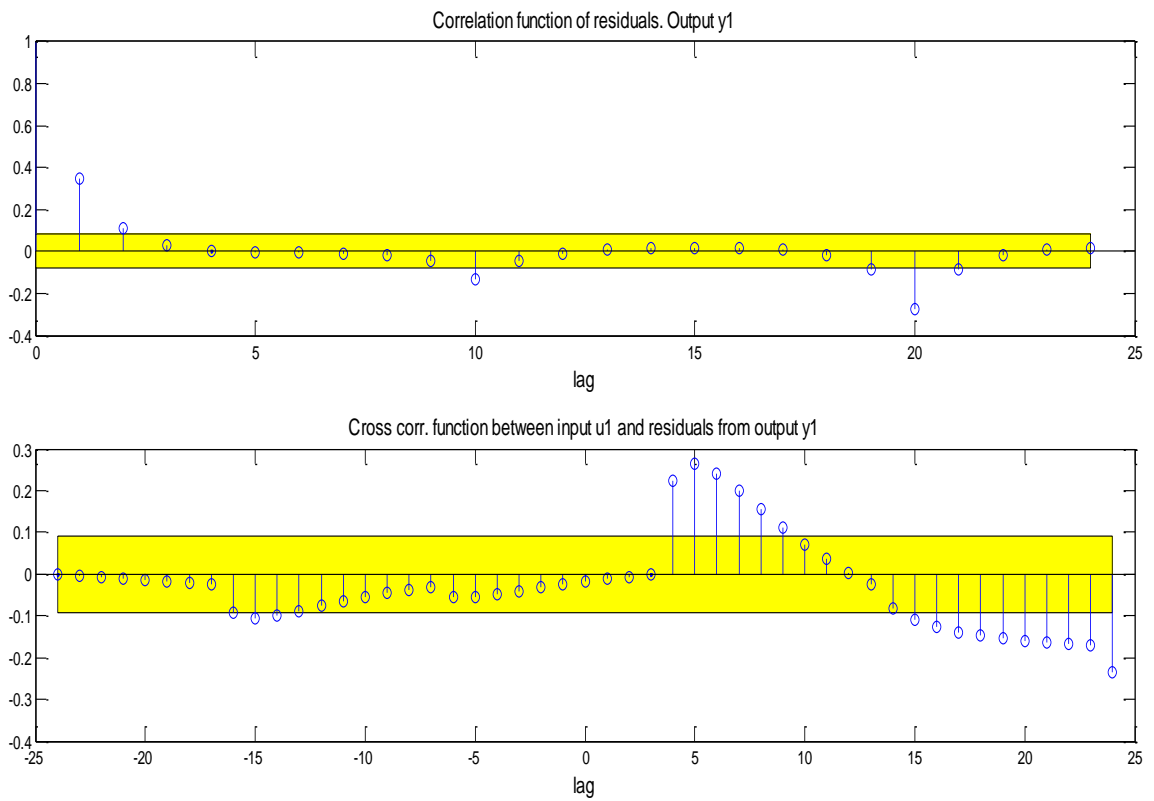

Figure 77: Residual Plot for ARX (First Order-APRBS)

Case Study 2 (na:2; nb:2; nc:2) (APRBS)

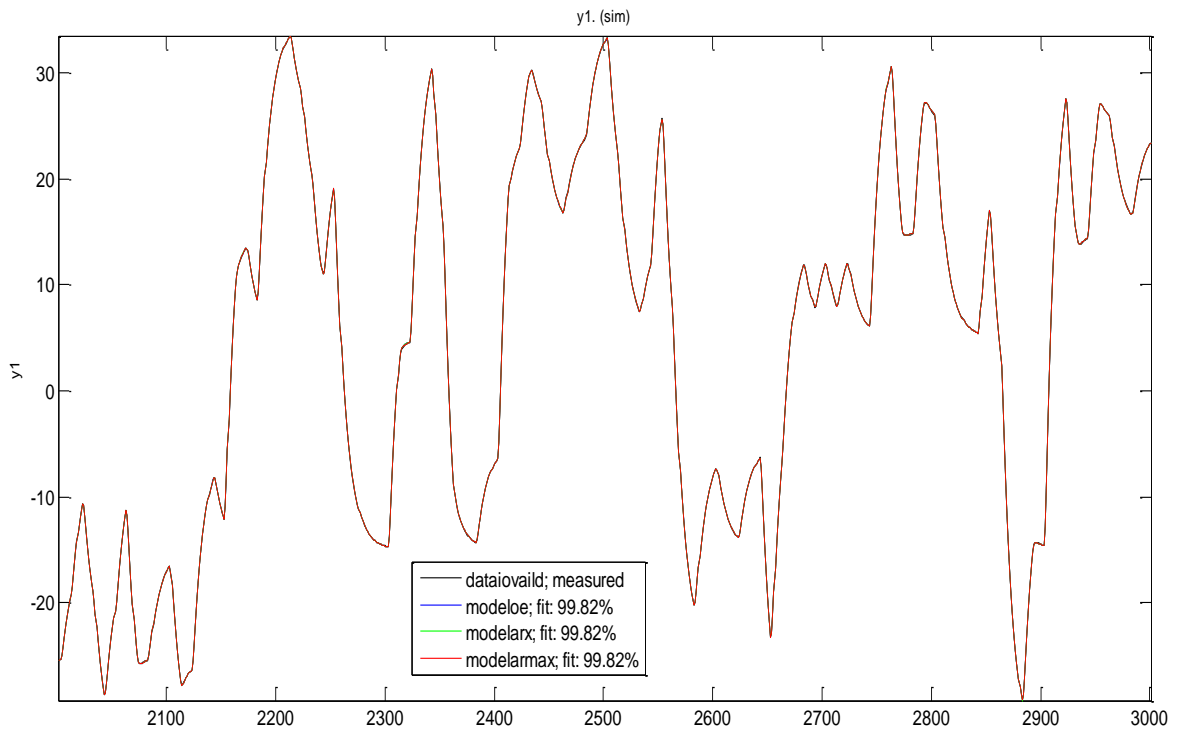

Figure 78: Comparison of model output with the actual measured values (Second Order-APRBS)

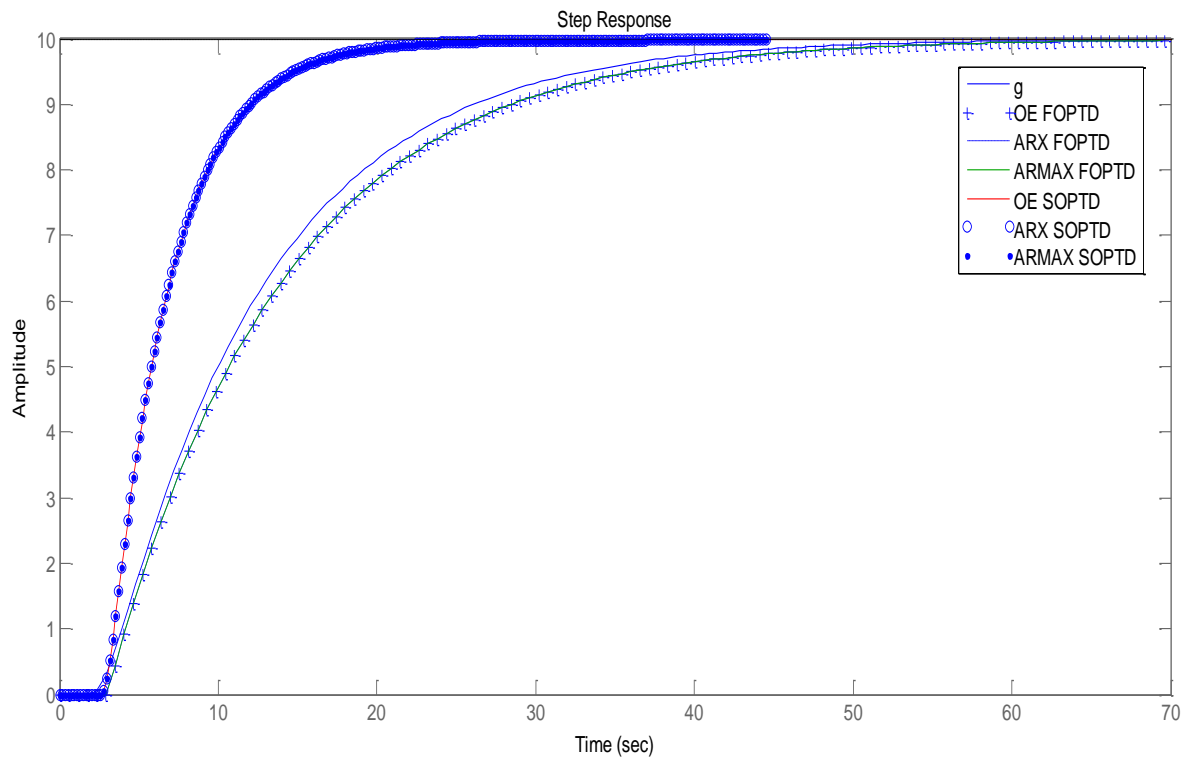

Figure 79: Step response for OE, ARX and ARMAX models (Second Order-APRBS)

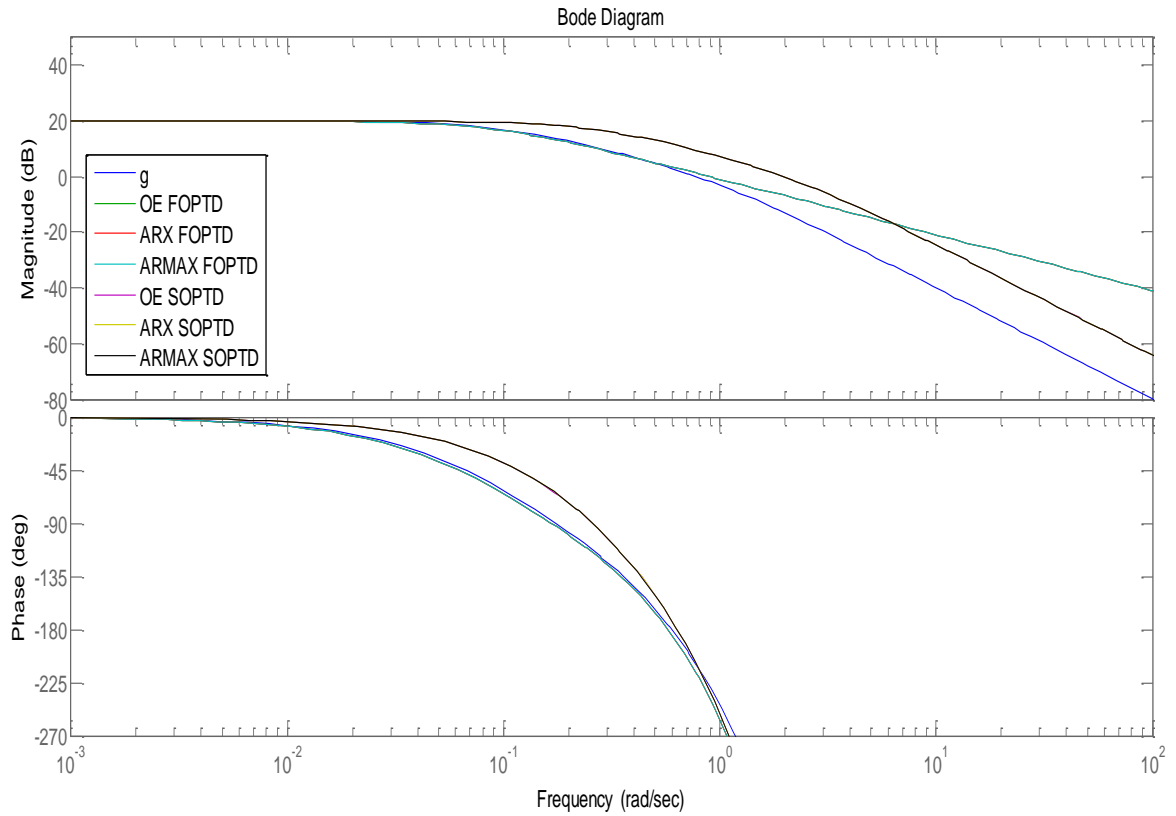

Figure 80: Bode Plot for OE, ARX and ARMAX models (Second Order-APRBS)

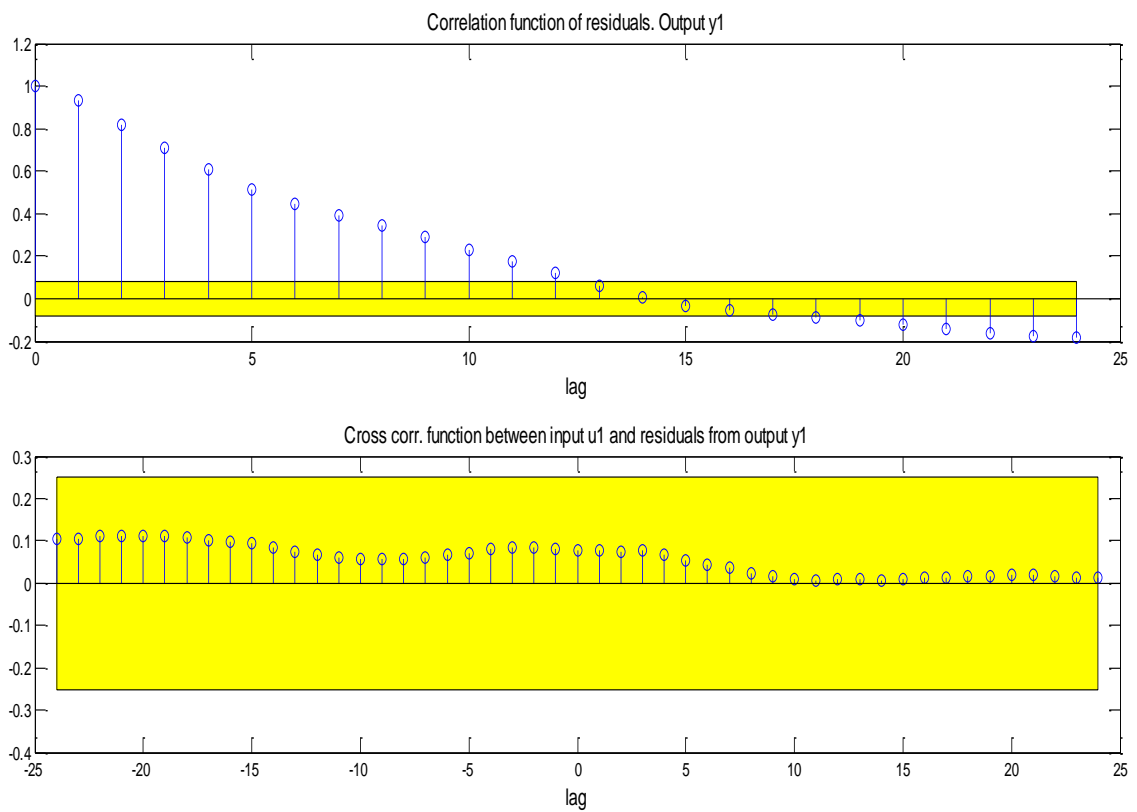

Figure 81: Residual Plot for OE (Second Order-APRBS)

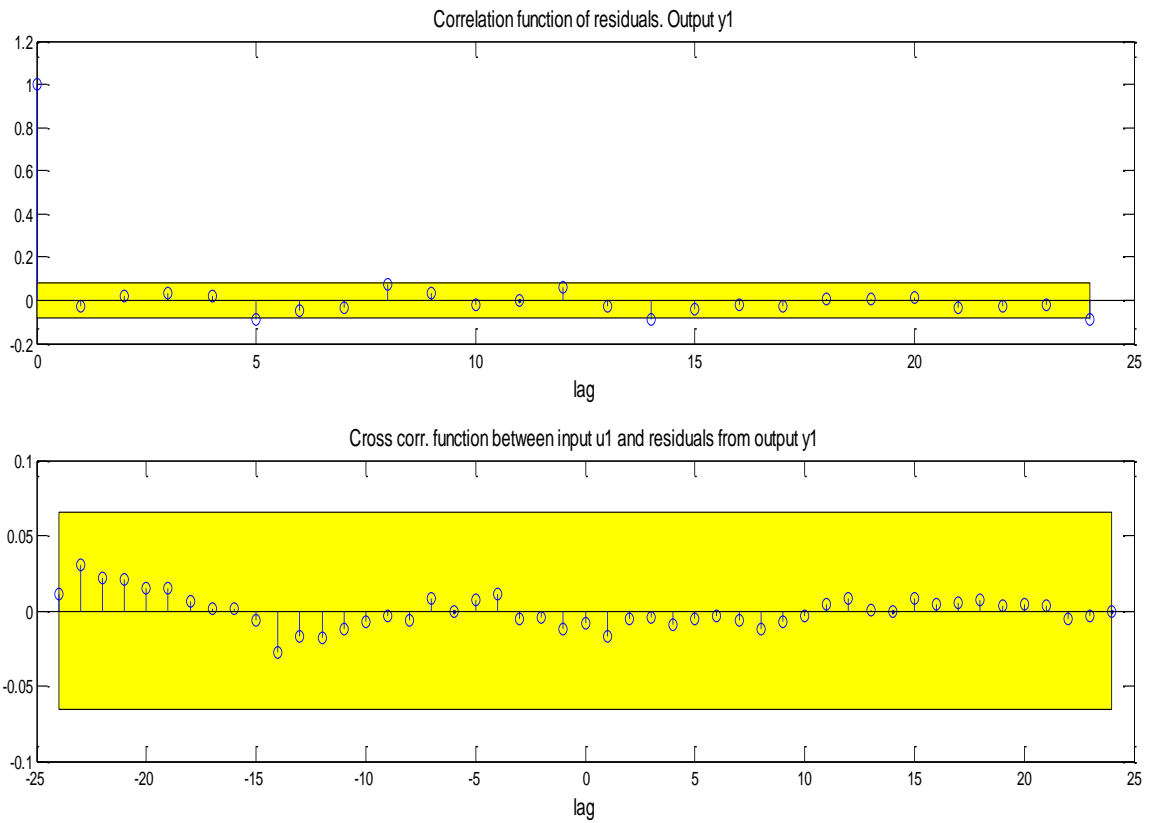

Figure 82: Residual Plot for ARMAX (Second Order-APRBS)

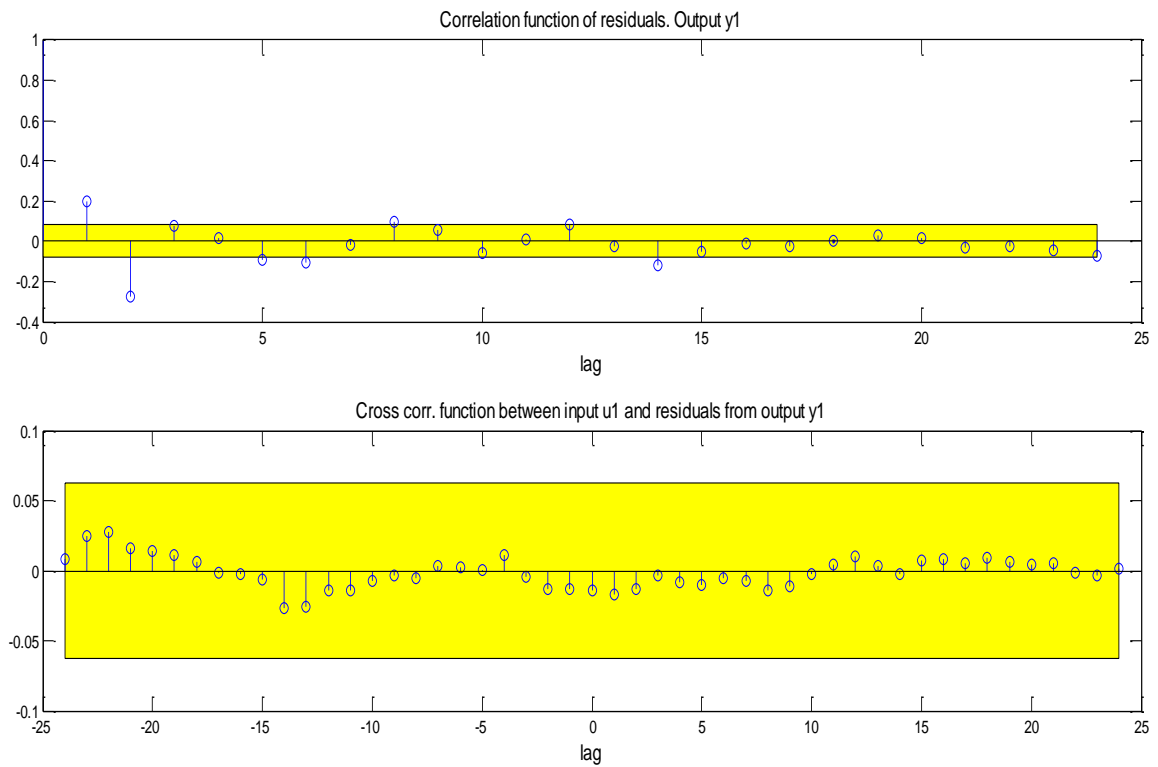

Figure 83: Residual Plot for ARX (Second Order-APRBS)

Case Study 3 (na:3; nb:3; nc:3) (APRBS)

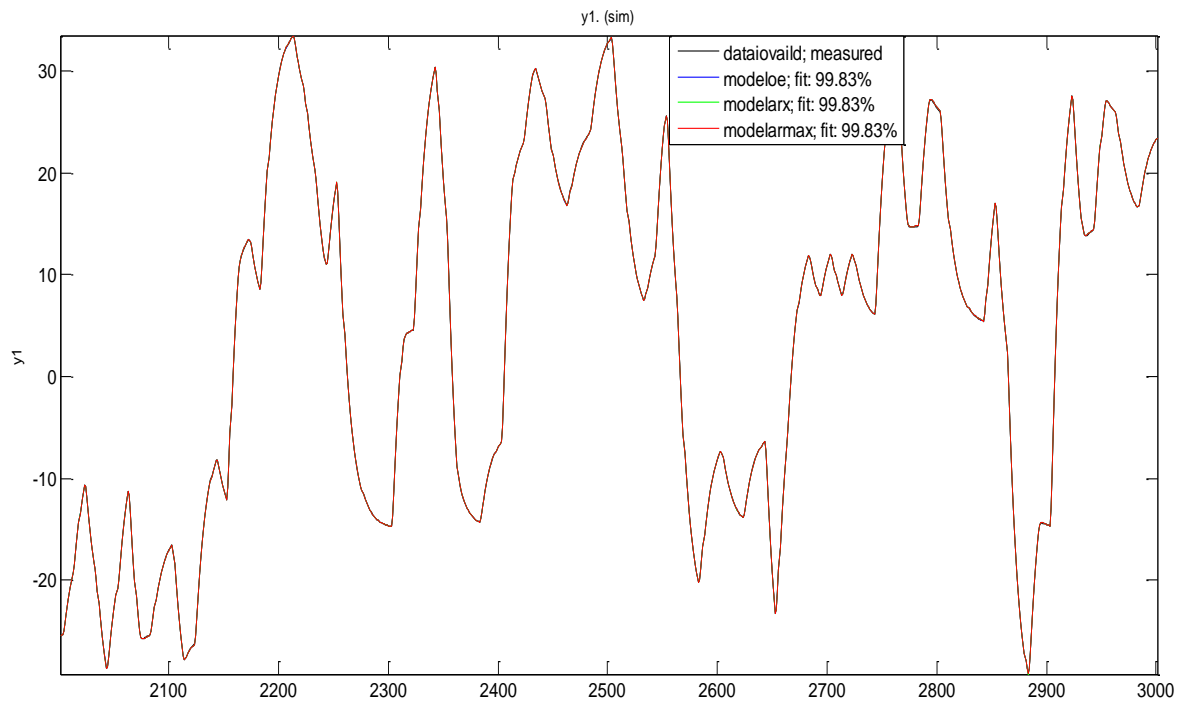

Figure 84: Comparison of model output with the actual measured values (Third Order-APRBS)

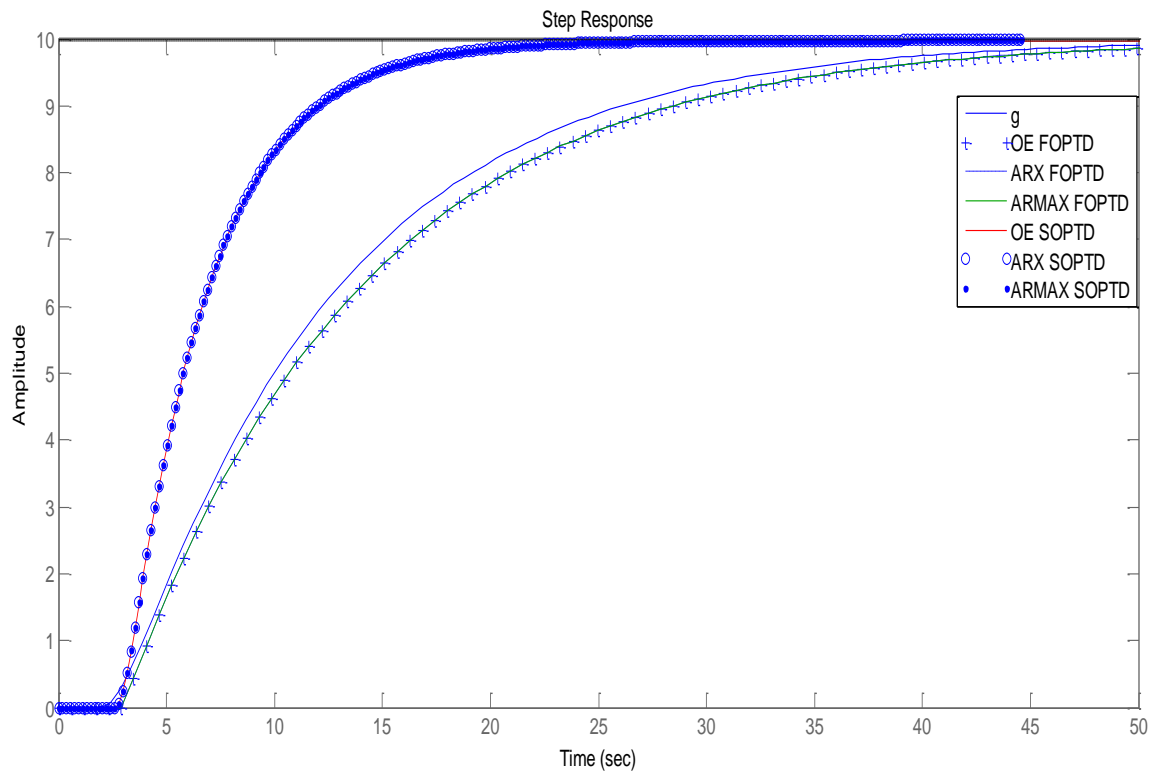

Figure 85: Step response for OE, ARX and ARMAX models (Third Order-APRBS)

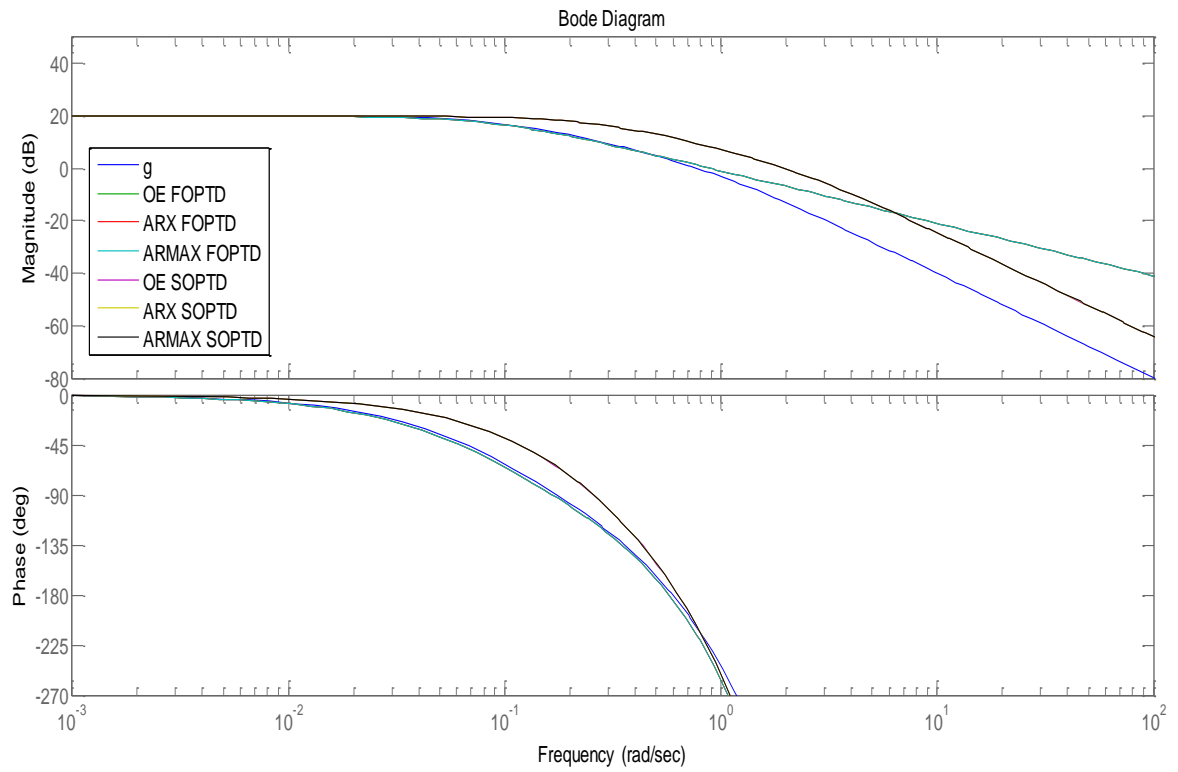

Figure 86: Bode Plot for OE, ARX and ARMAX models (Third Order-APRBS)

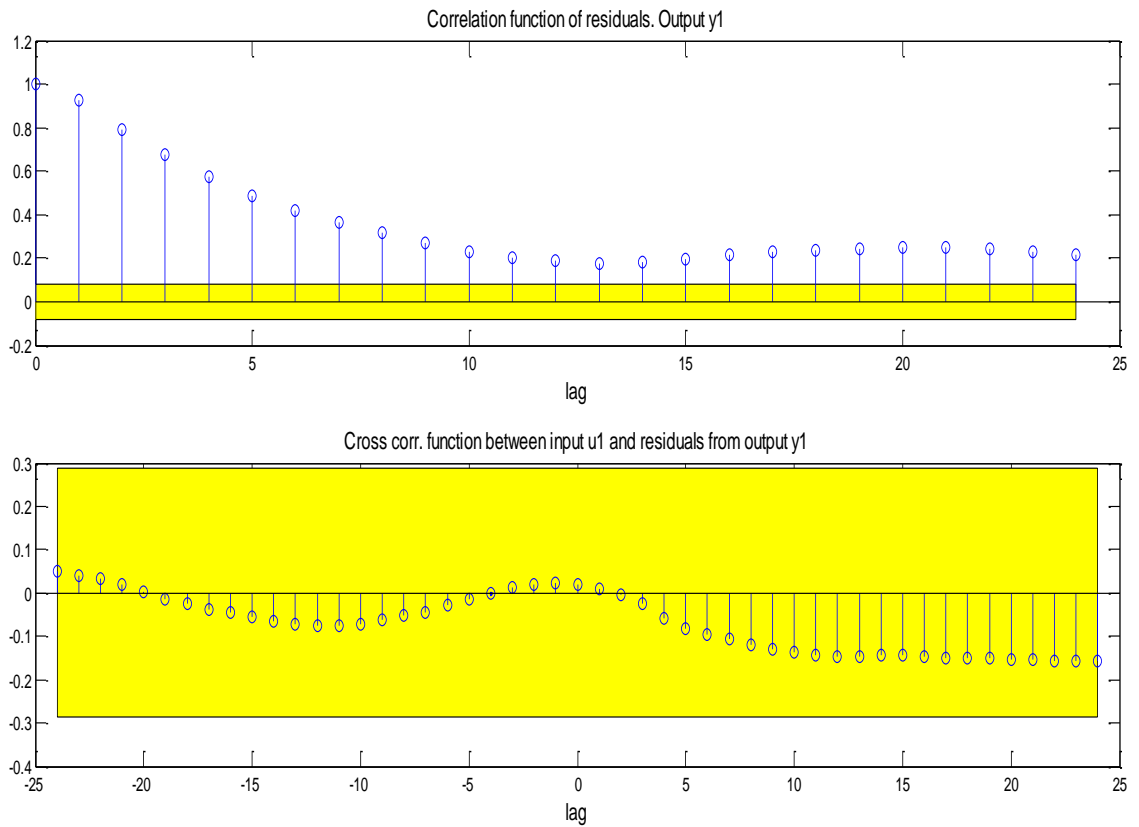

Figure 87: Residual Plot for OE (Third Order-APRBS)

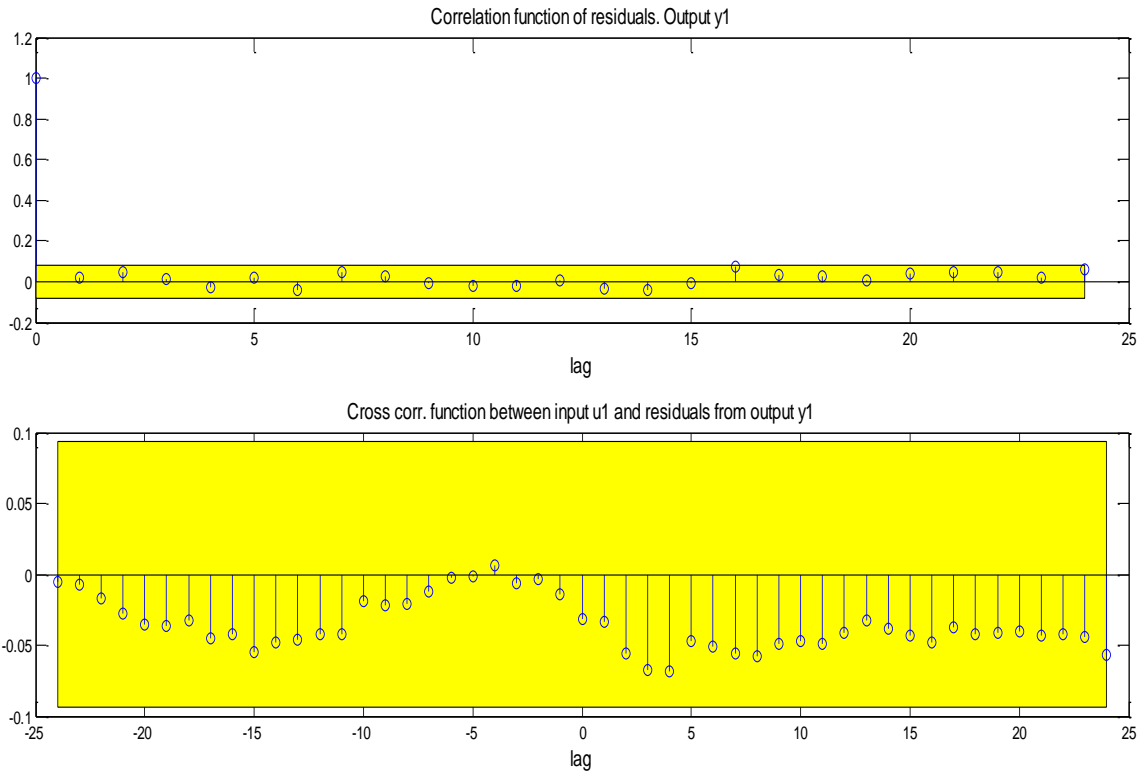

Figure 88: Residual Plot for ARMAX (Third Order-APRBS)

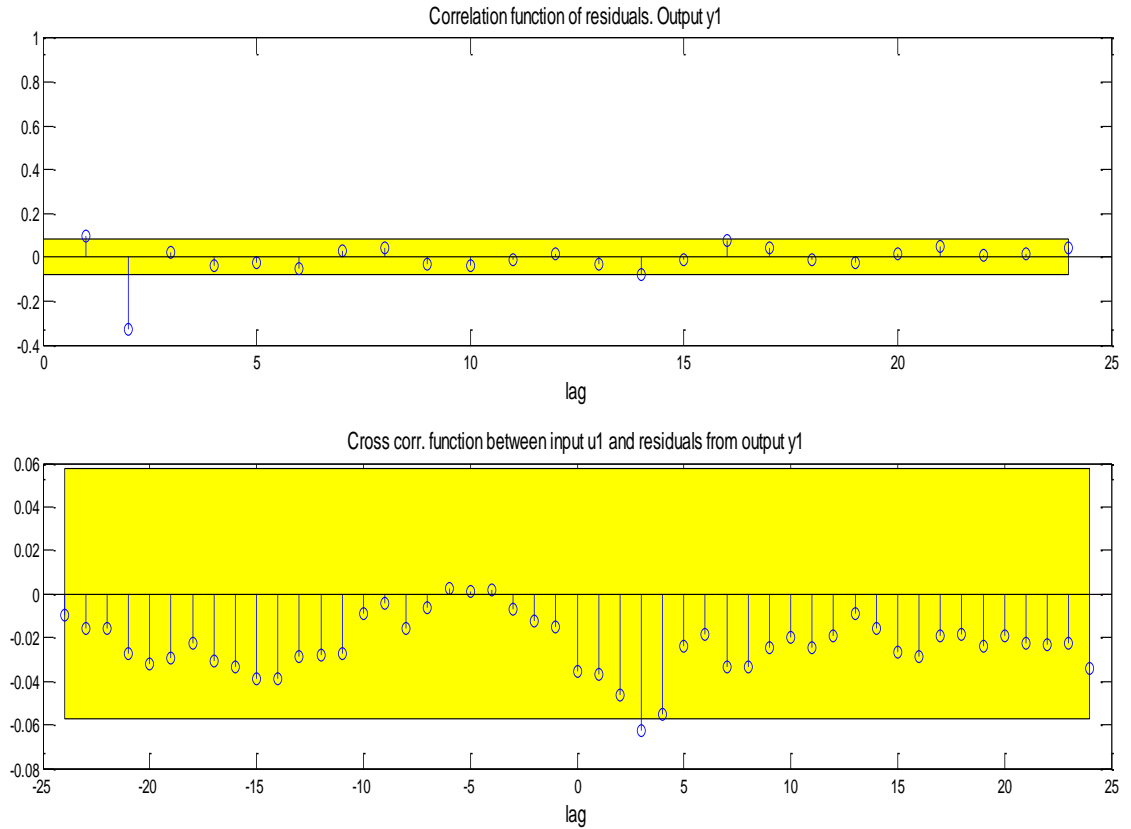

Figure 89: Residual Plot for OE (Third Order-APRBS)

Case Study 4 (na:4; nb:4; nc:4) (APRBS)

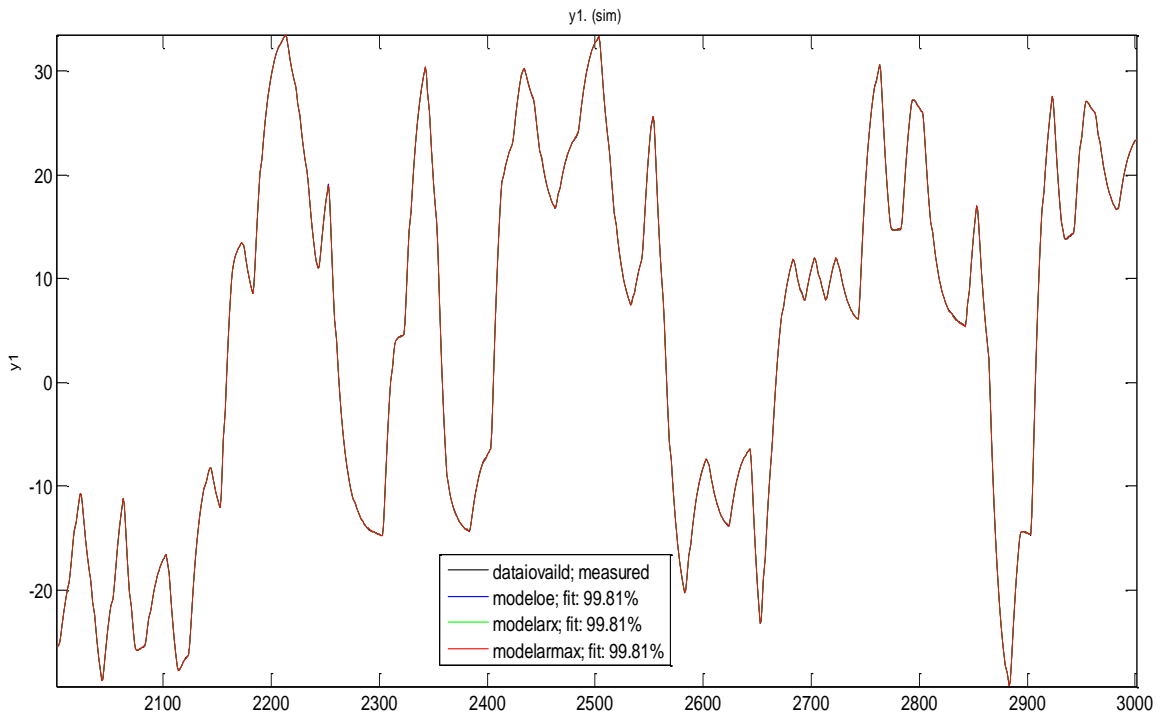

Figure 90: Comparison of model output with the actual measured values (Fourth Order-APRBS)

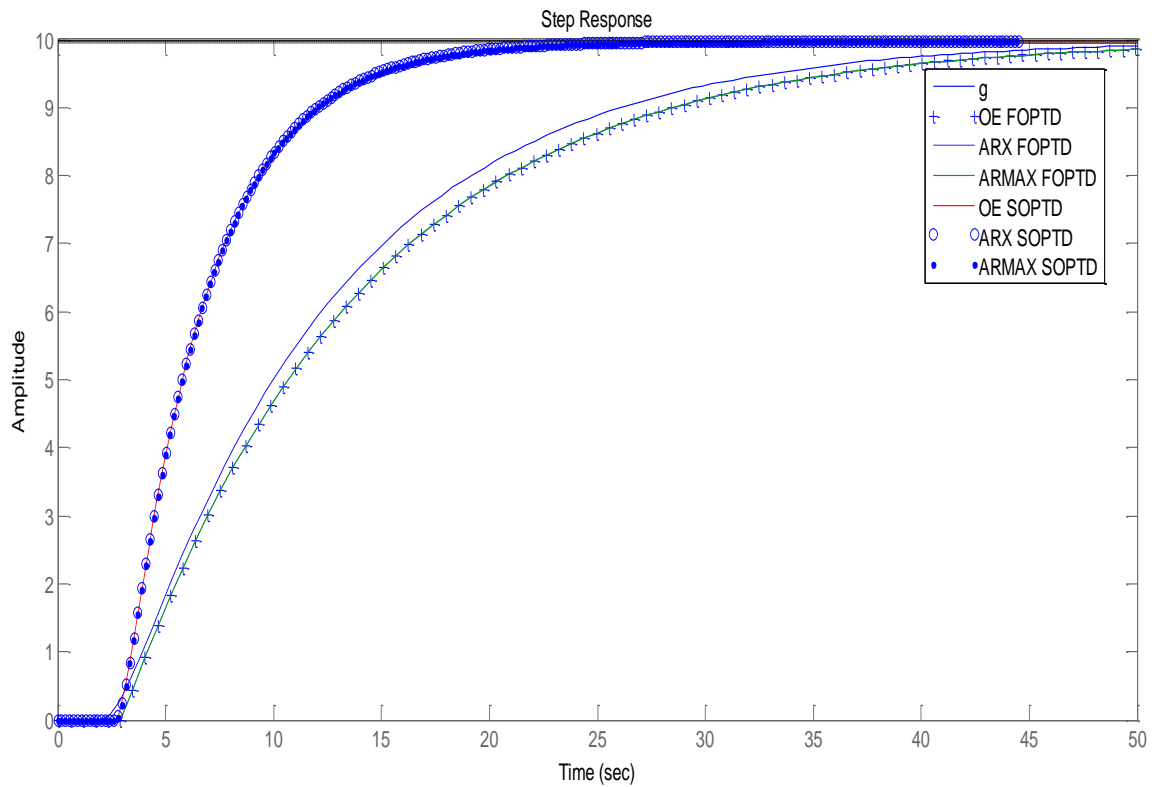

Figure 91: Step response for OE, ARX and ARMAX models (Fourth Order-APRBS)

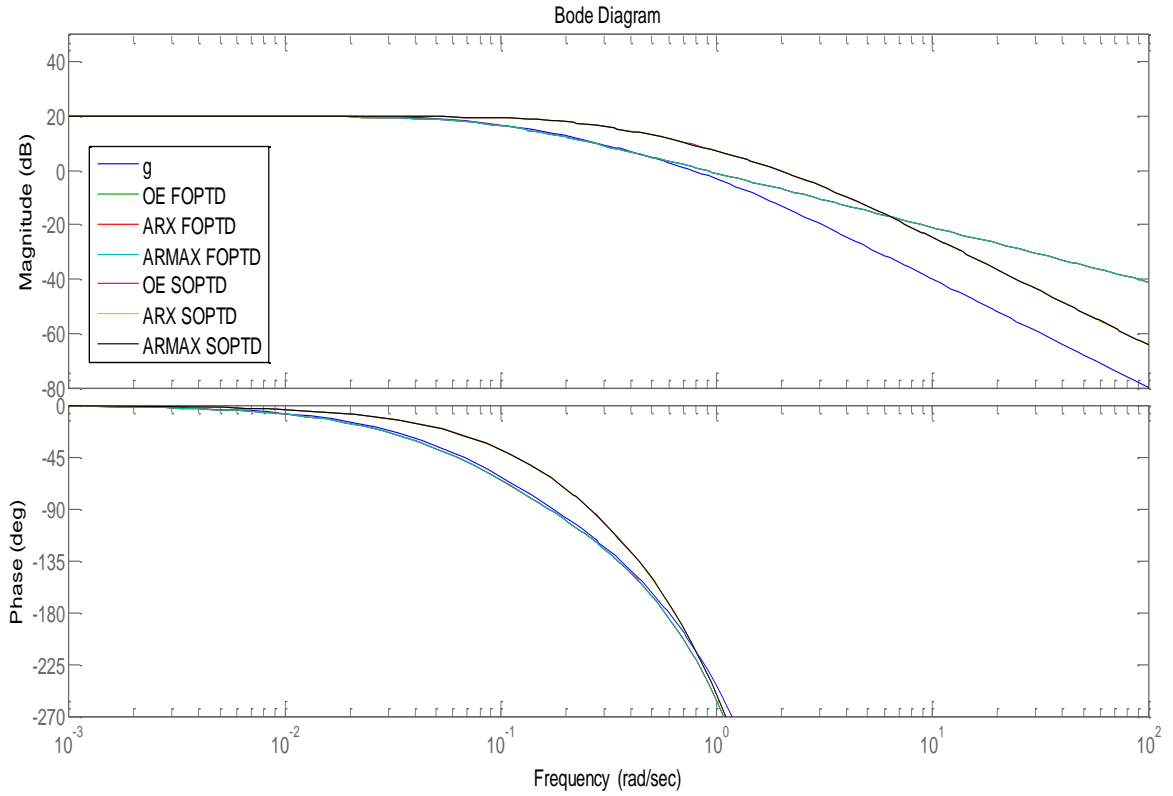

Figure 92: Bode Plot for OE, ARX and ARMAX models (Fourth Order-APRBS)

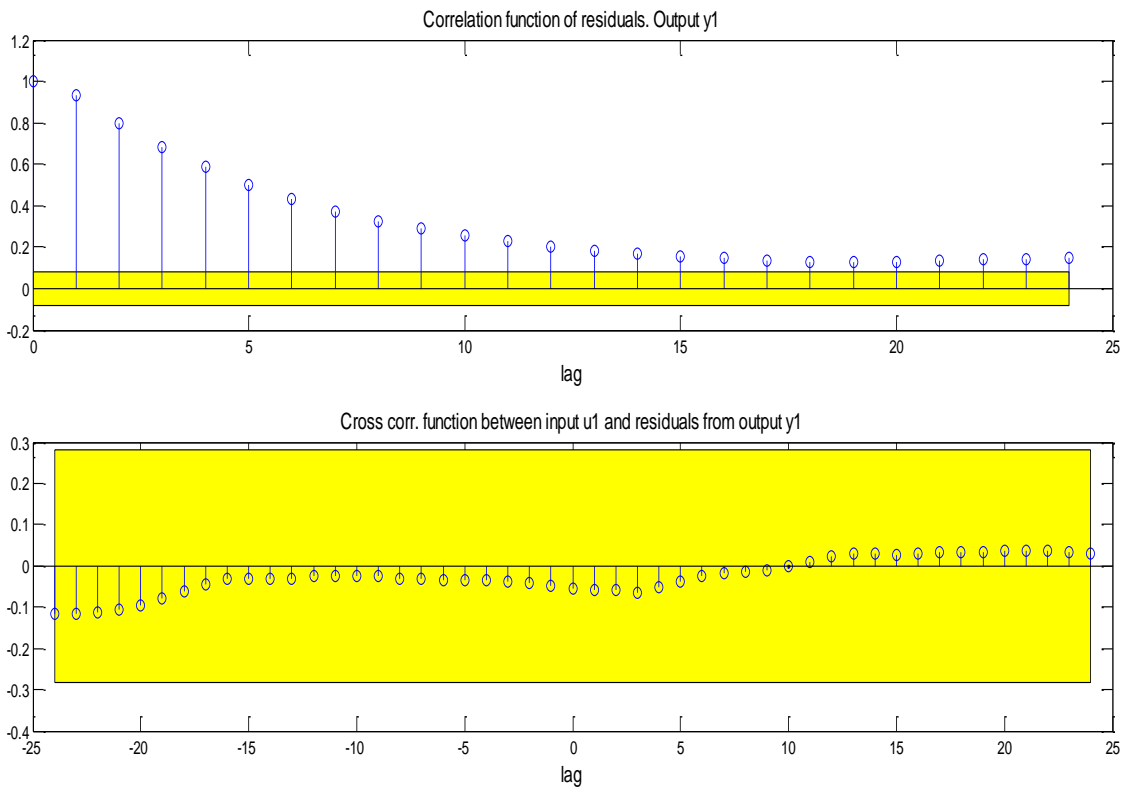

Figure 93: Residual Plot for OE (Fourth Order-APRBS)

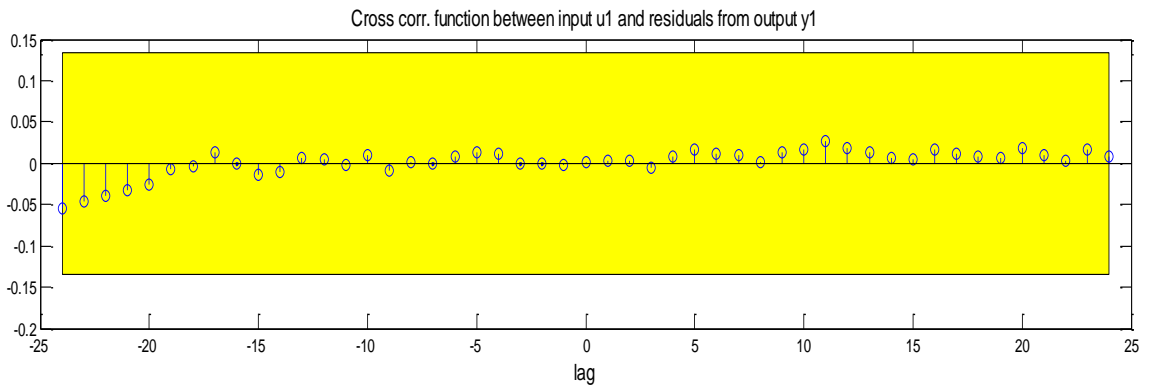
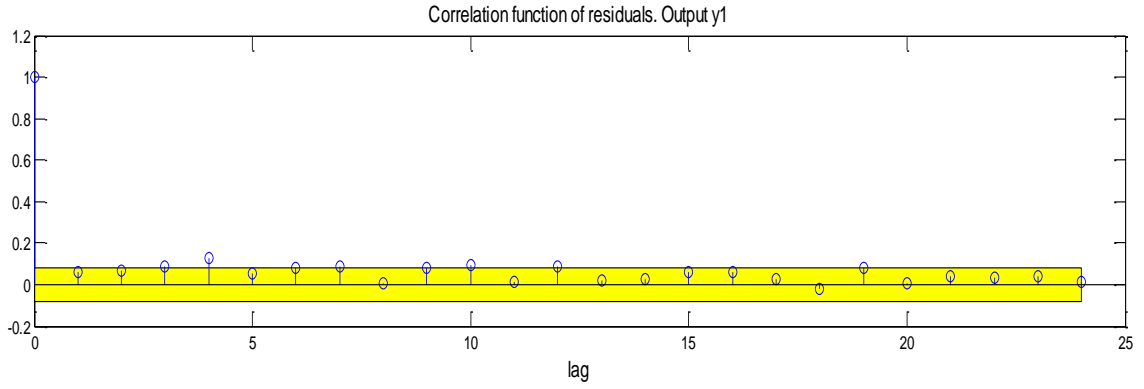

Figure 94: Residual Plot for ARMAX (Fourth Order-APRBS)

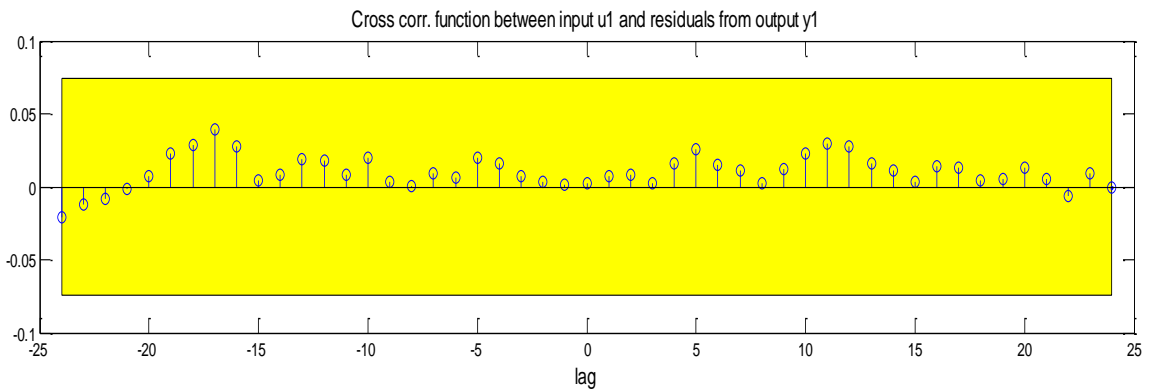
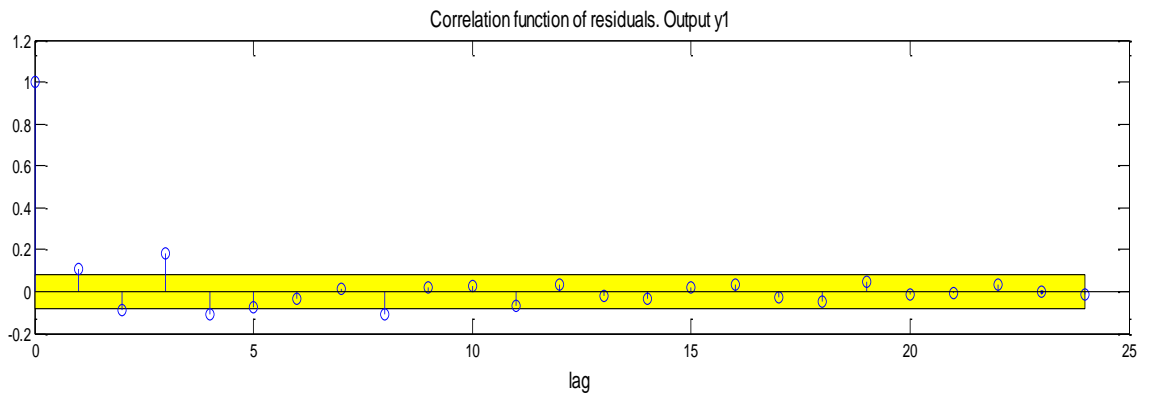

Figure 95: Residual Plot for ARX (Fourth Order-APRBS)

Case Study 5 (na:5; nb:5; nc:5) (APRBS)

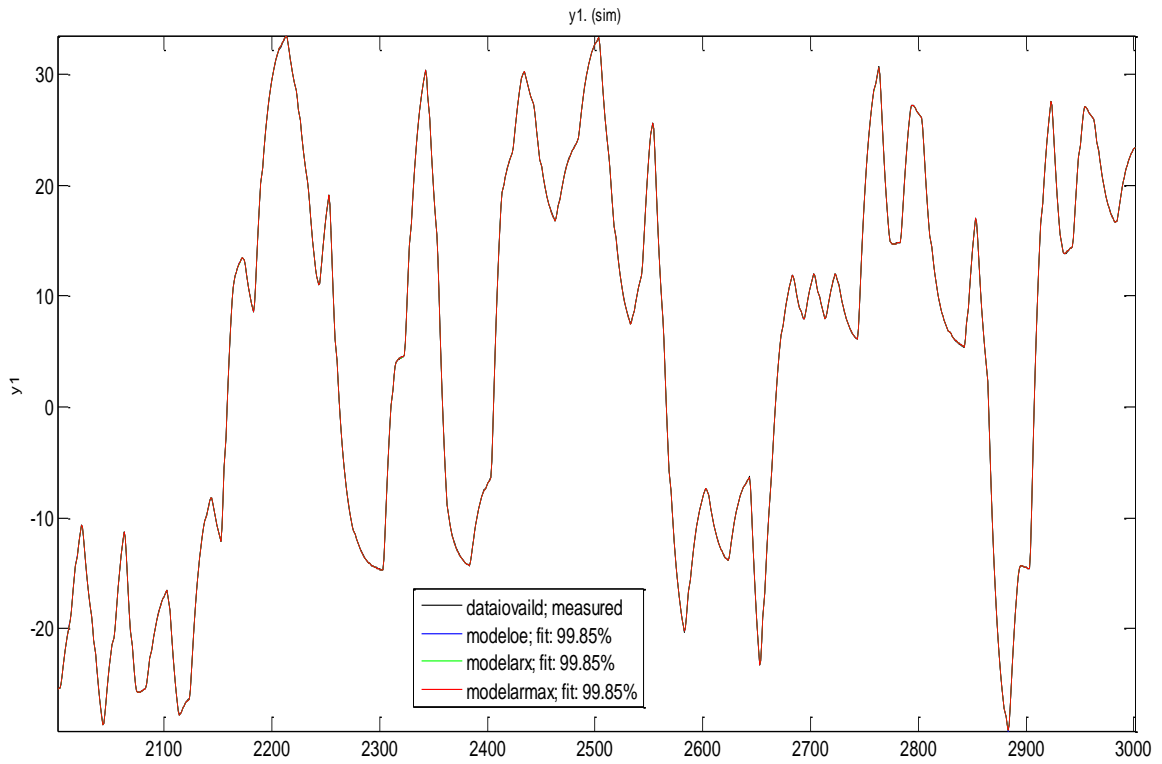

Figure 96: Comparison of model output with the actual measured values (Fifth Order-APRBS)

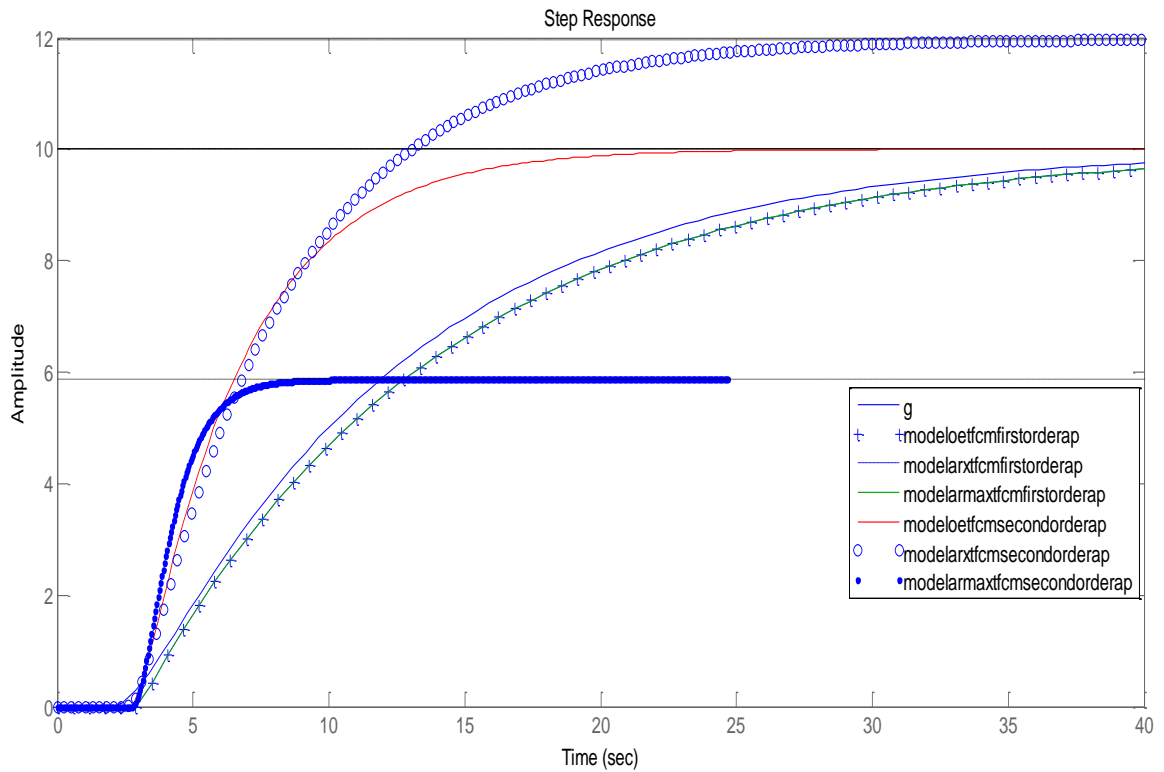

Figure 97: Step response for OE, ARX and ARMAX models (Fifth Order-APRBS)

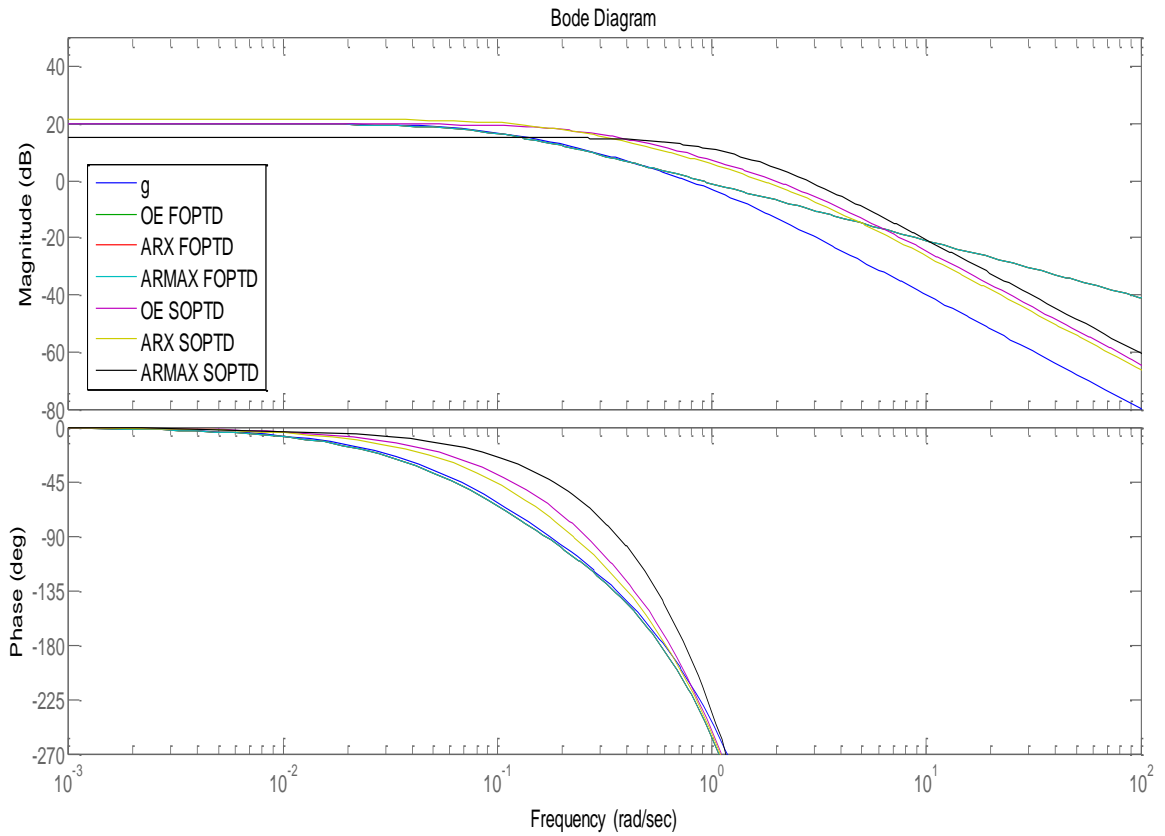

Figure 98: Bode Plot for OE, ARX and ARMAX models (Fifth Order-APRBS)

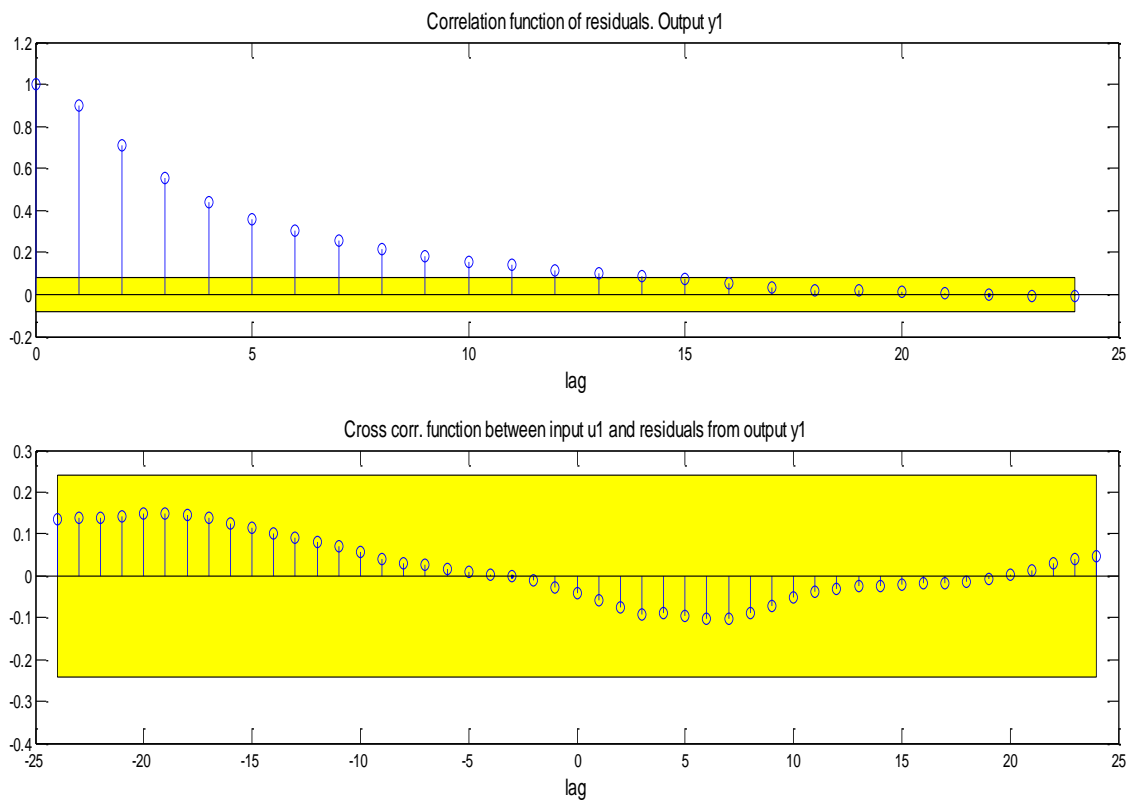

Figure 99: Residual Plot for OE (Fifth Order-APRBS)

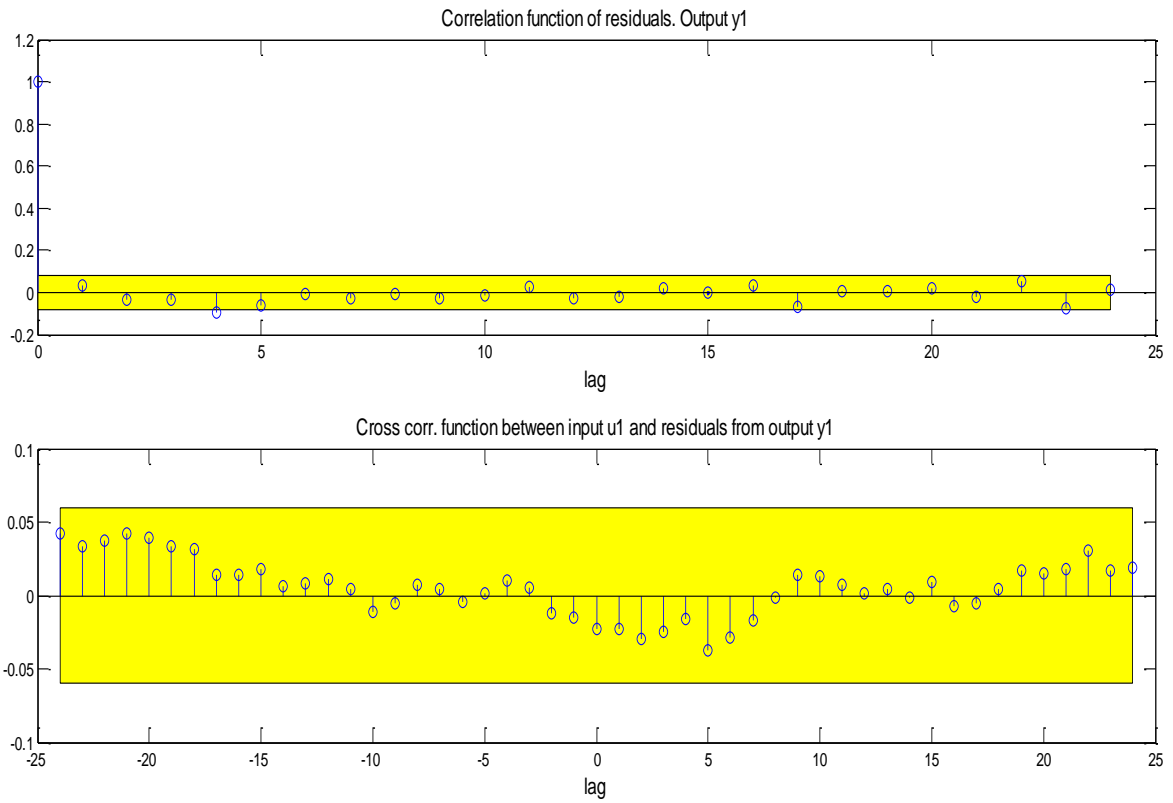

Figure 100: Residual Plot for ARMAX (Fifth Order-APRBS)

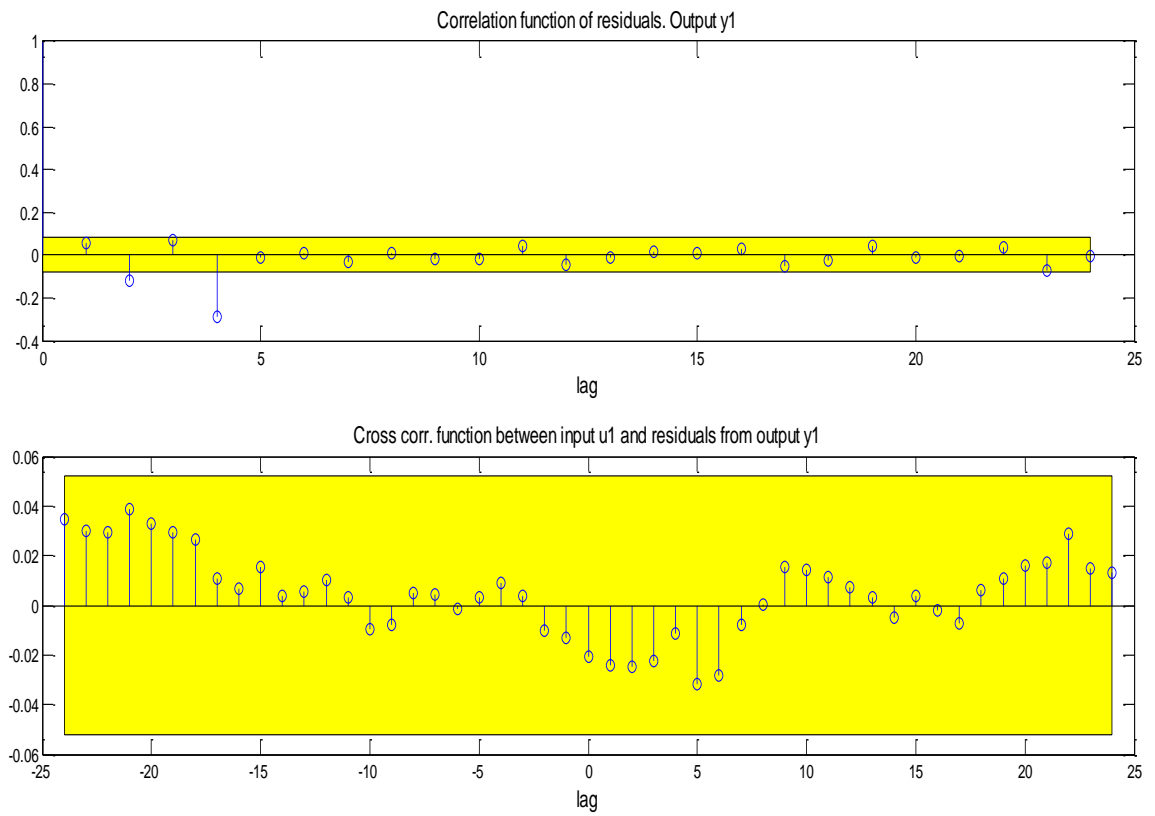

Figure 101: Residual Plot for OE (Fifth Order-APRBS)

The system is disturbed by white Gaussian noise (WGN). All the three models approximately give the same fitting for each case study. But, the fitting gets better when the excitation signal is changed from PRBS to APRBS. This can be observed in Figure 42 and Figure 72. APRBS gives different amplitude for each stage in PRBS. The amplitude used for PRBS is $[-1 \ 1]$ where else, APRBS amplitudes are $[-2 \ 2] + [-1 \ 1] + [-0.5 \ 0.5]$. A standard PRBS is obtained at first. Then, a number of trials are counted and the interval from the minimum to the maximum input is divided into few possible levels. Finally, each step in the PRBS is given a random level in order to get APRBS signal (Nelles, 2001). It can be said that, for APRBS the input space is well enclosed with data.

Besides that, the fitting is higher at the second order of PRBS signal (Figure 48) which is 99.56%. Third order also gives the same result. As the order increased to 4 and 5, the fitting started to reduce. This may result due consistency problem as discussed in First System. The highest fitting obtained by using APRBS signal is 99.85% which is resulted at fifth order (Figure 96). Second order gives 99.82% which is better compared to PRBS signal. In this case, as the order increases, the fitting gets better. It follows the general rule of system identification.

Second, third and fourth orders of PRBS signal give the same result for step response. In Figure 49 (step response), SOPTD system stabilizes first which is at 20 seconds followed by original system and FOPTD. This is considered faster if compared to first order which is 30 seconds. All the model lines are overlying on each other for FOPTD and SOPTD. The Bode diagram (Figure 50) shows that the frequency is lower at second, third and fourth order compared to the first order. Figure 51-53 show that the residual correlation functions and cross-correlation of the residuals with the input are within the confidence interval. It indicates that the residuals are uncorrelated and it is a good model. In addition, APRBS gives the same response as PRBS for step response and Bode diagram. The APRBS residual plot result is better than PRBS.

Besides minimum and maximum amplitudes, minimal hold time (the shortest period of time for the signal to stay constant) also plays a major role in this case. It determines the number of steps in the signal. Thus, it will influence the characteristics of frequency. Typically, for linear system identification, the minimum hold time will be same as sampling time.

As a conclusion, it can be said that APRBS excitation signal gives the best result compared to PRBS signal. The optimal order for this system is second order since it gives good model fitting. Besides that, OE model gives the best response compared to other models, even though the difference is small.

The third system used is first order system plus time delay model (FOPTD);

$$\text{System, } g(s) = \frac{1}{(s+1)} e^{-0.5s}$$

2000 data points were used for identification, in which the range is from 1-2000, where else; 1000 points were used for validation purpose (2001-3001). The sampling time is equal to 1. Figure 102 and 103 show the input $u(k)$ and output $y(k)$ which are plotted against time by using PRBS and APRBS excitation signals.

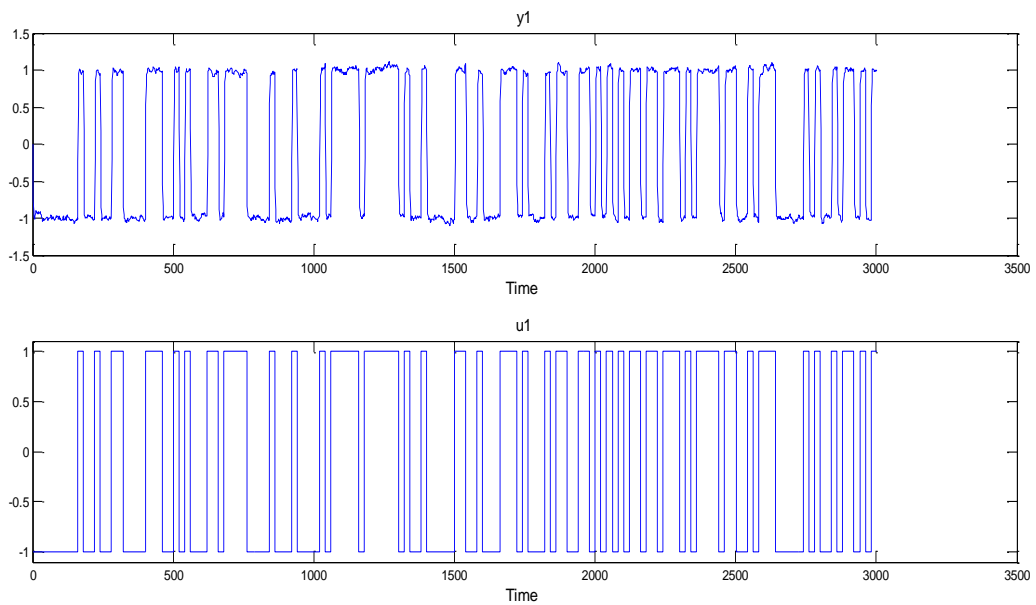

Figure 102: Input,u & Output,y vs. Time (PRBS)

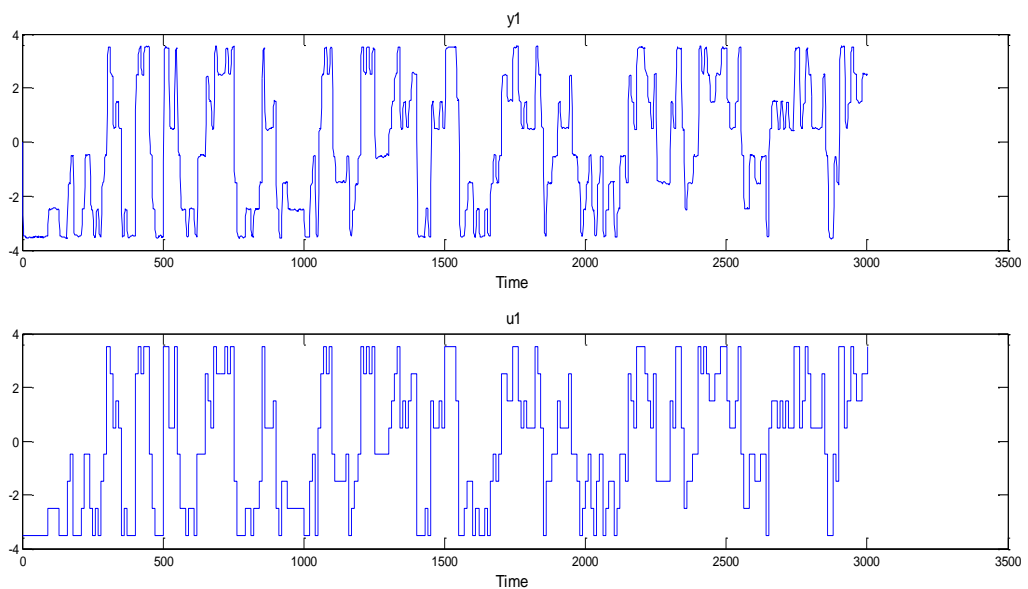

Figure 103: Input,u & Output,y vs. Time (APRBS)

The first 100 measured input and output values are included in Appendix 3.

In this section, the comparison of amplitude modulated PRBS (APRBS) and PRBS excitation signals will be discussed as third system. First, the fitting, step response, bode diagram and residual plots will be illustrated which obtained through PRBS signal. There are five case studies with different orders (first order until fifth order). A first order plus time delay system is considered in the interval $[-1 \ 1]$ with probability of shift (p) equal to 0.05.

Case Study 1 (na:1; nb:1; nc:1) (PRBS)

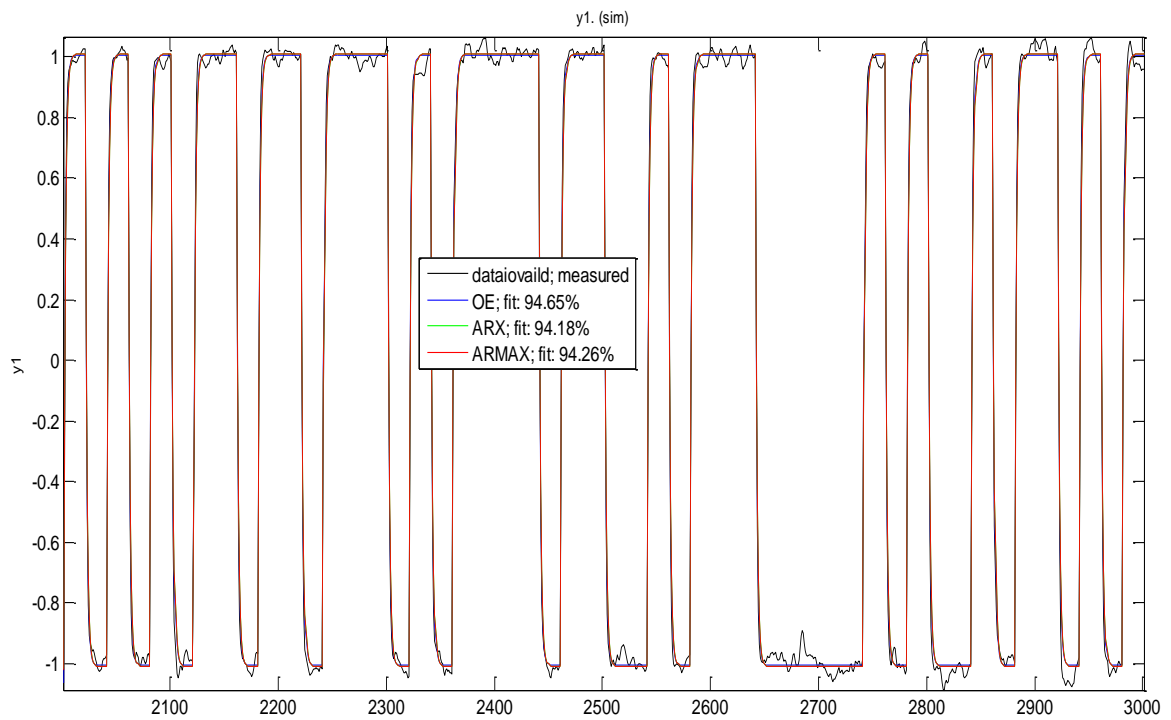

Figure 104: Comparison of model output with the actual measured values (First Order-PRBS)

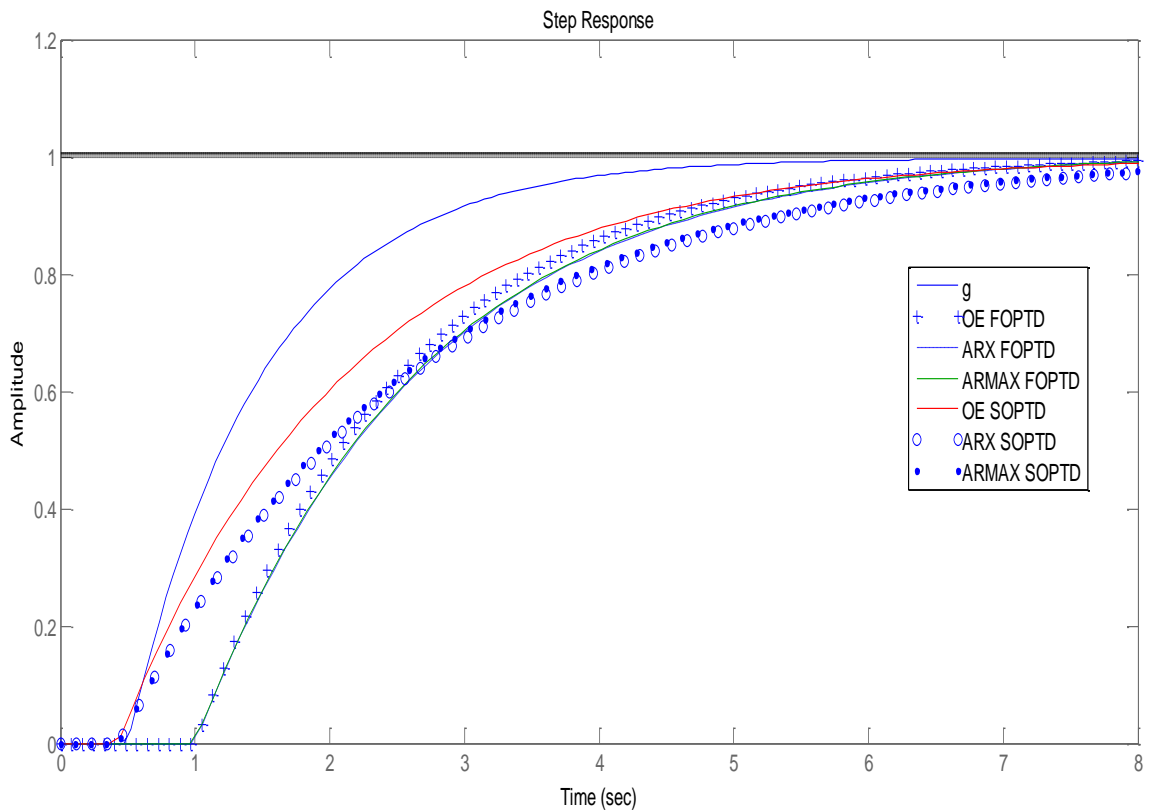

Figure 105: Step response for OE, ARX and ARMAX models (First Order-PRBS)

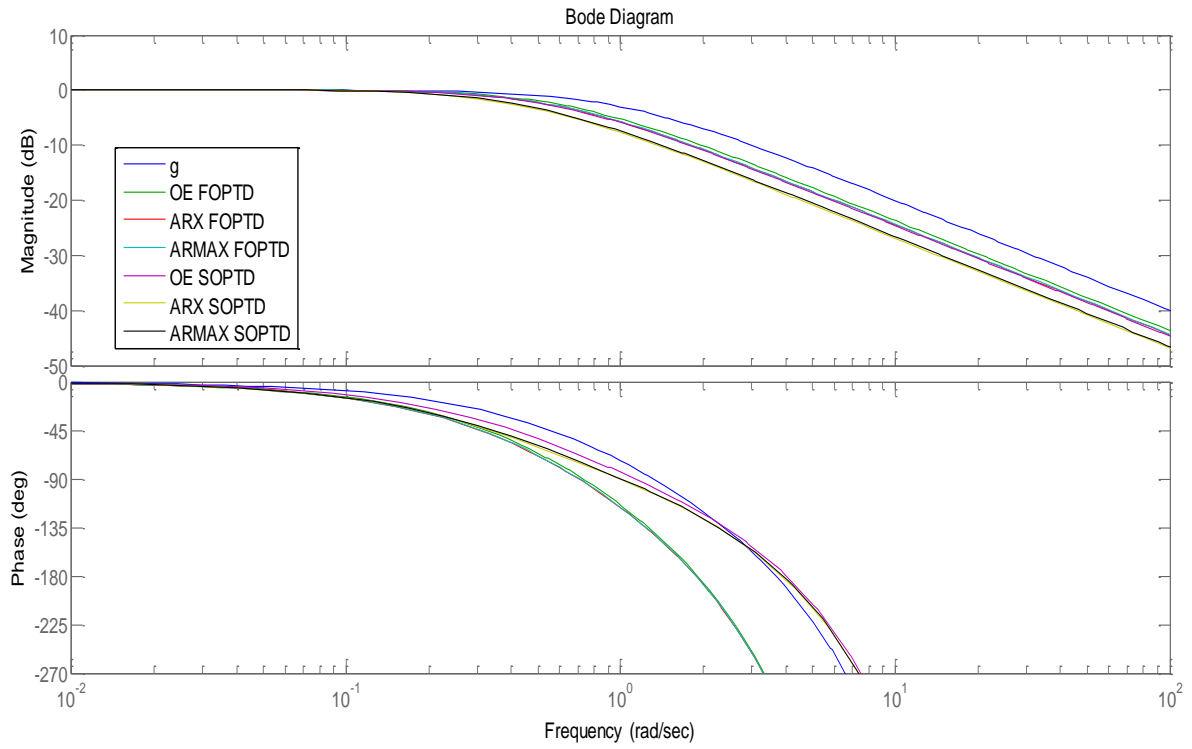

FIGURE 106: BODE PLOT FOR OE, ARX AND ARMAX MODELS (FIRST ORDER-PRBS)

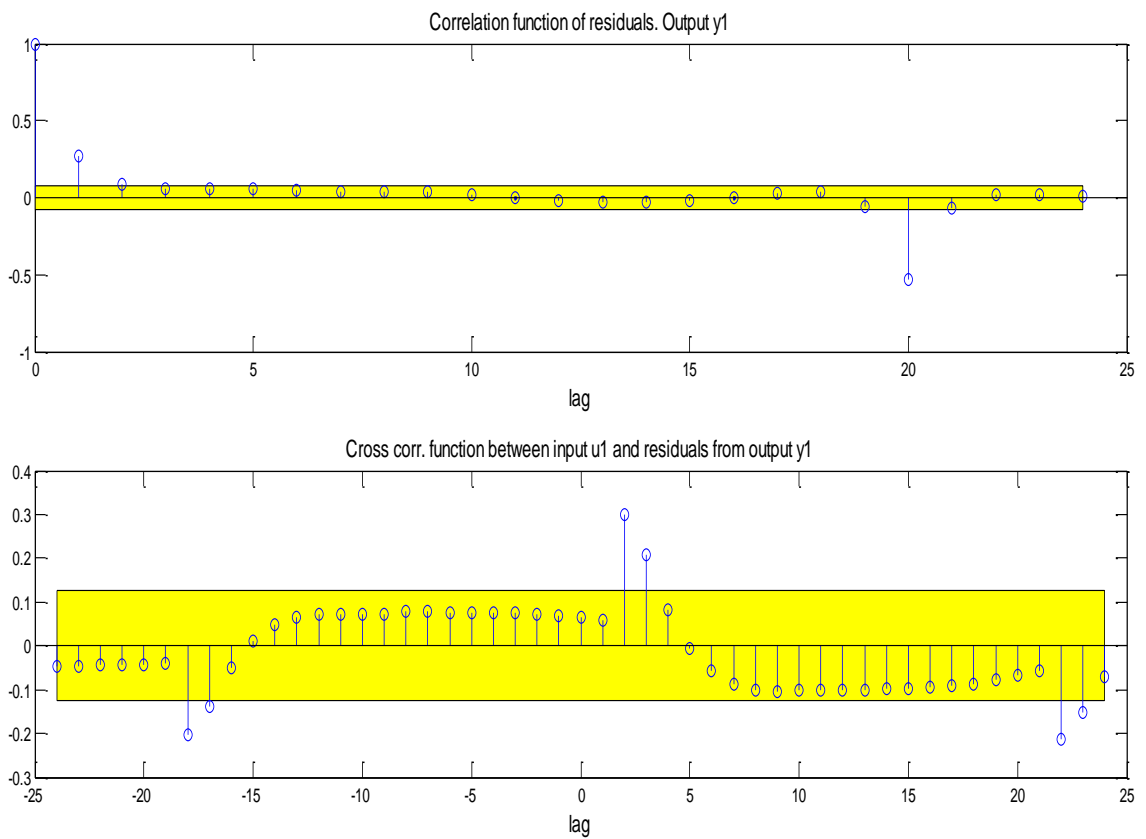

Figure 107: Residual Plot for OE (First Order-PRBS)

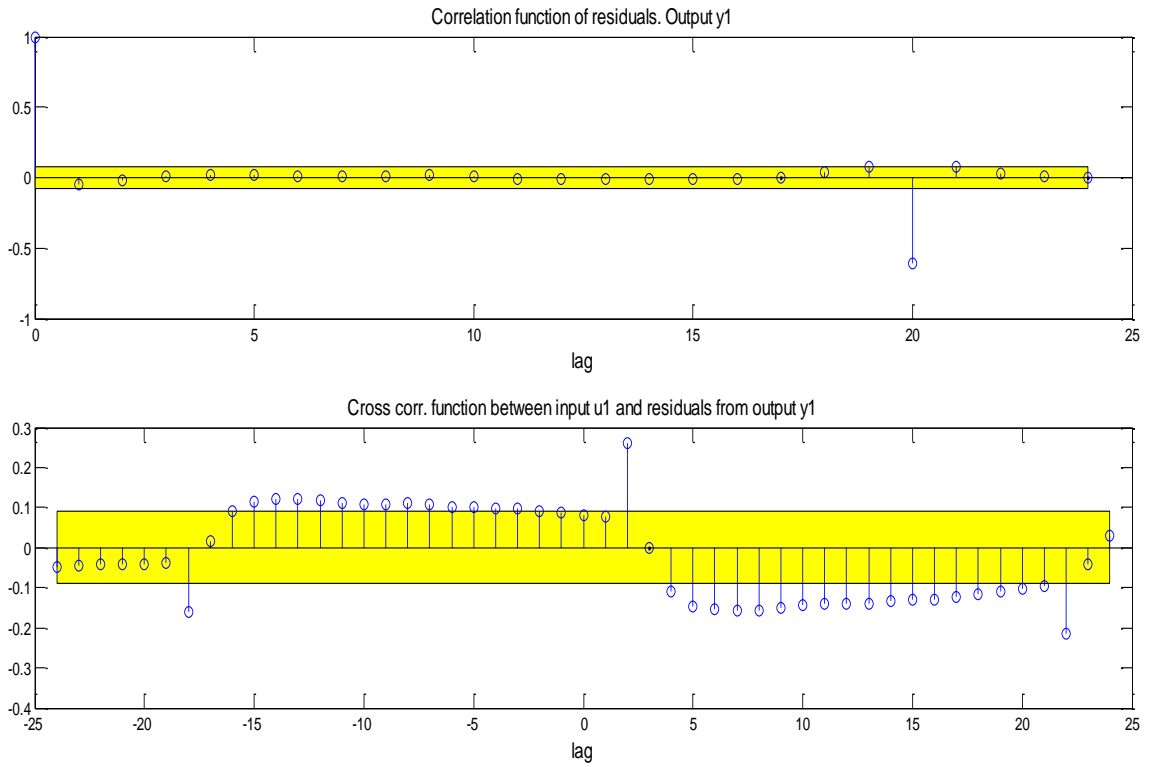

Figure 108: Residual Plot for ARMAX (First Order-PRBS)

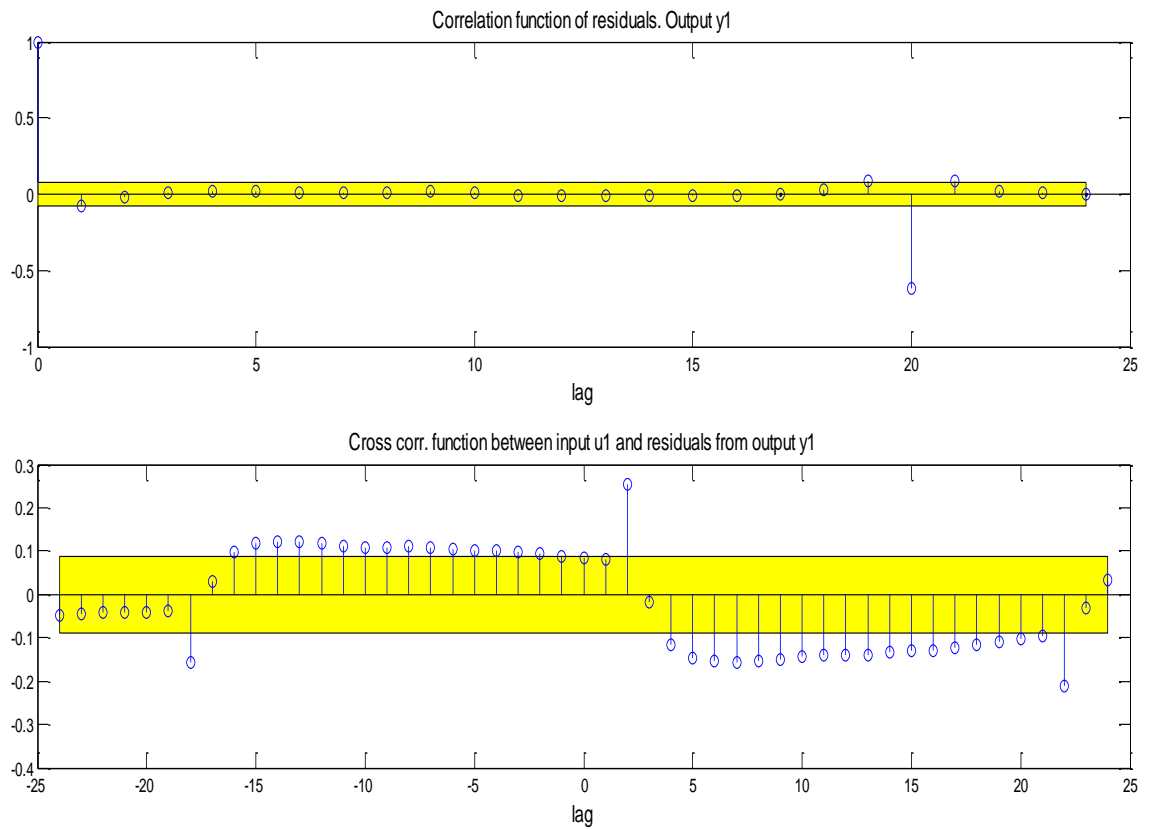

Figure 109: Residual Plot for ARX (First Order-PRBS)

Case Study 2 (na:2; nb:2; nc:2) (PRBS)

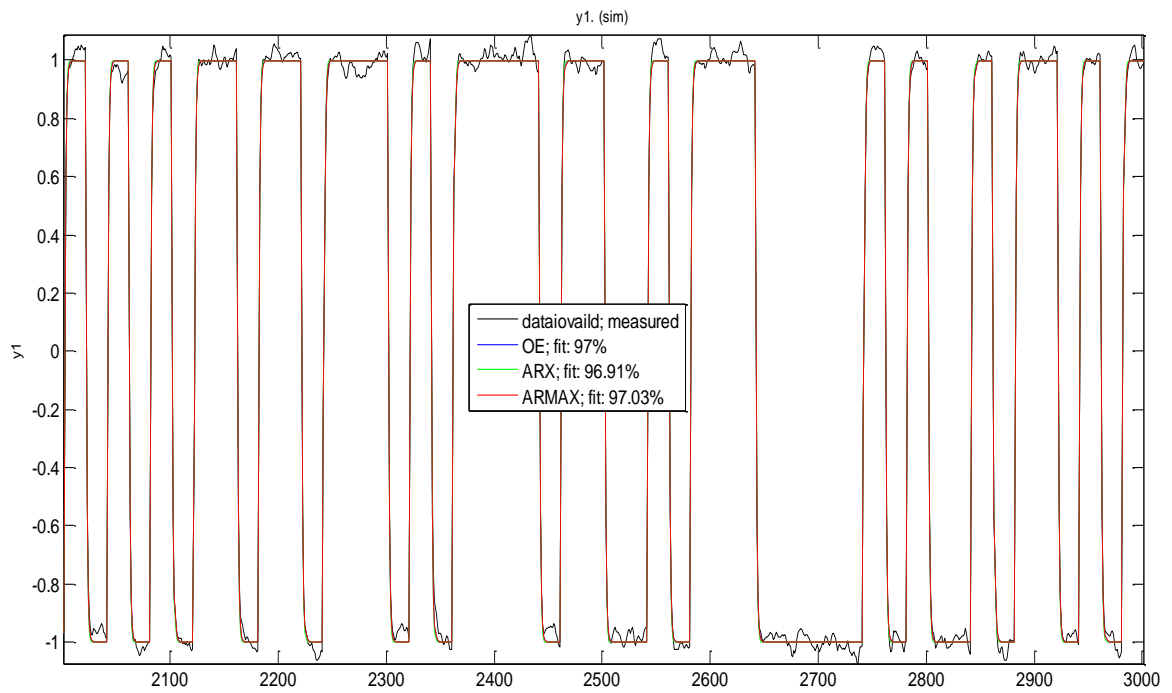

Figure 110: Comparison of model output with the actual measured values (Second Order-PRBS)

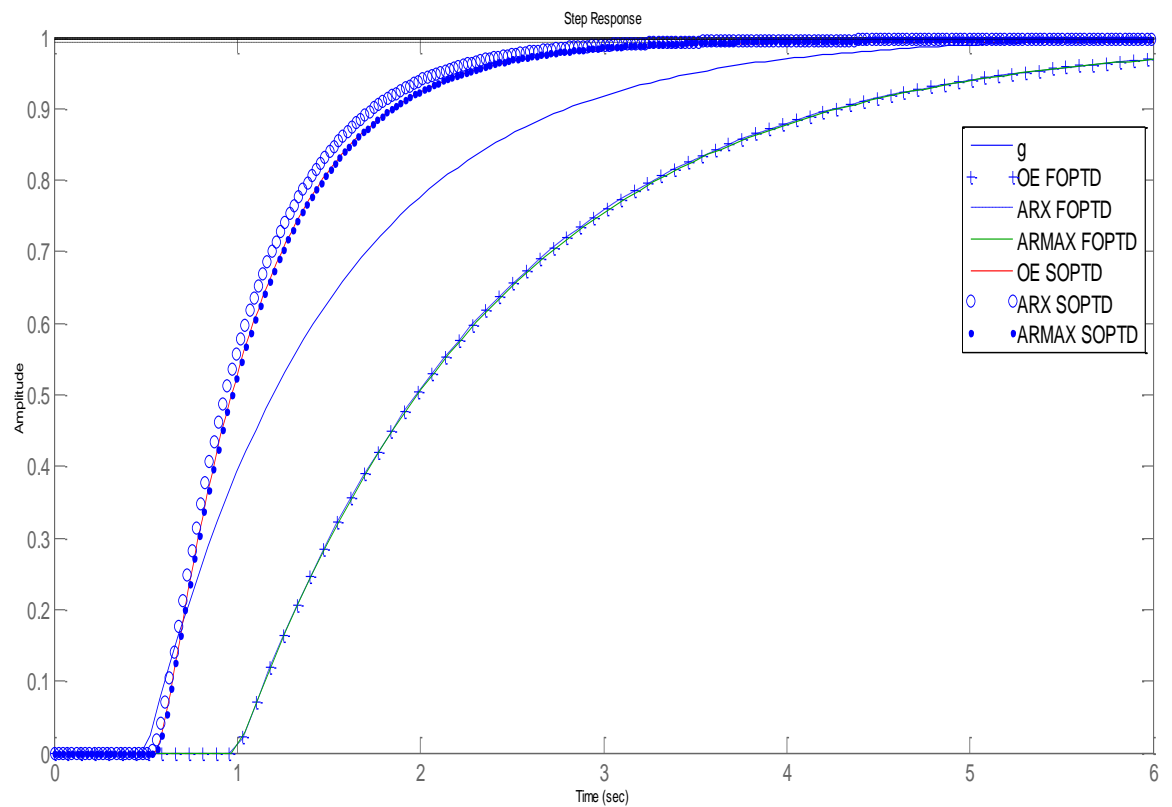

Figure 111: Step response for OE, ARX and ARMAX models (Second Order-PRBS)

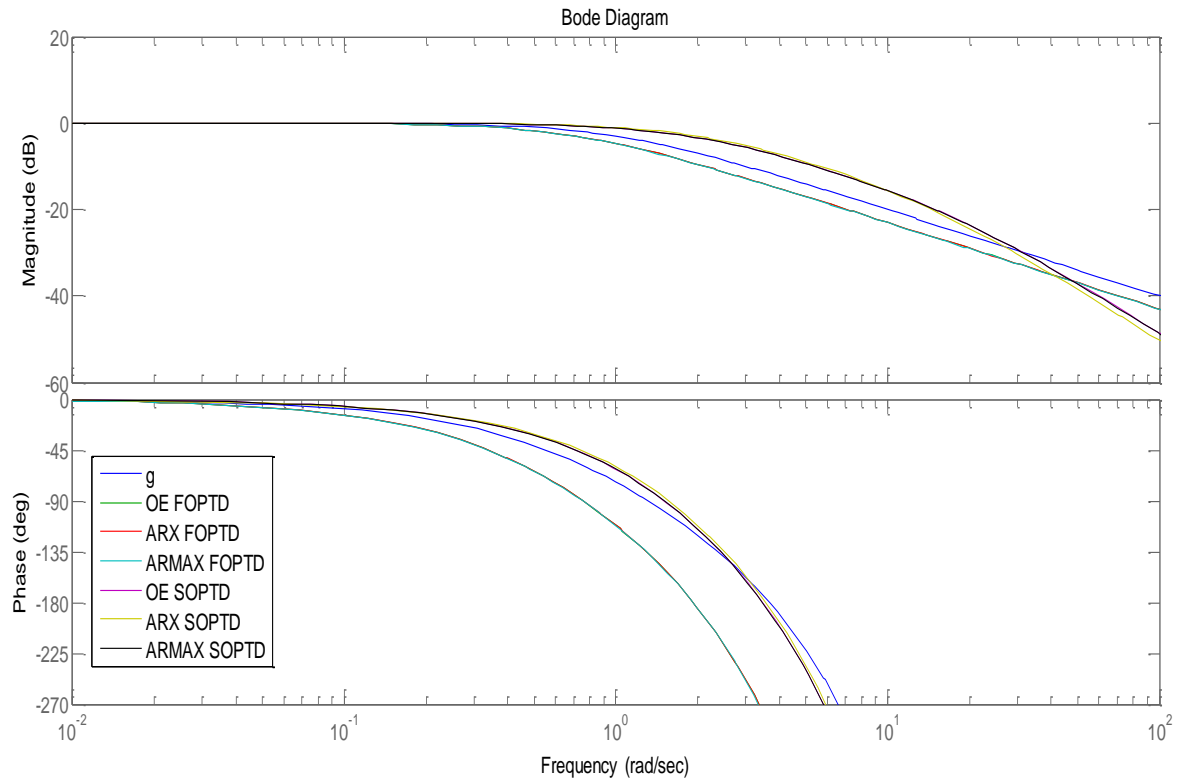

Figure 112: Bode Plot for OE, ARX and ARMAX models (Second Order-PRBS)

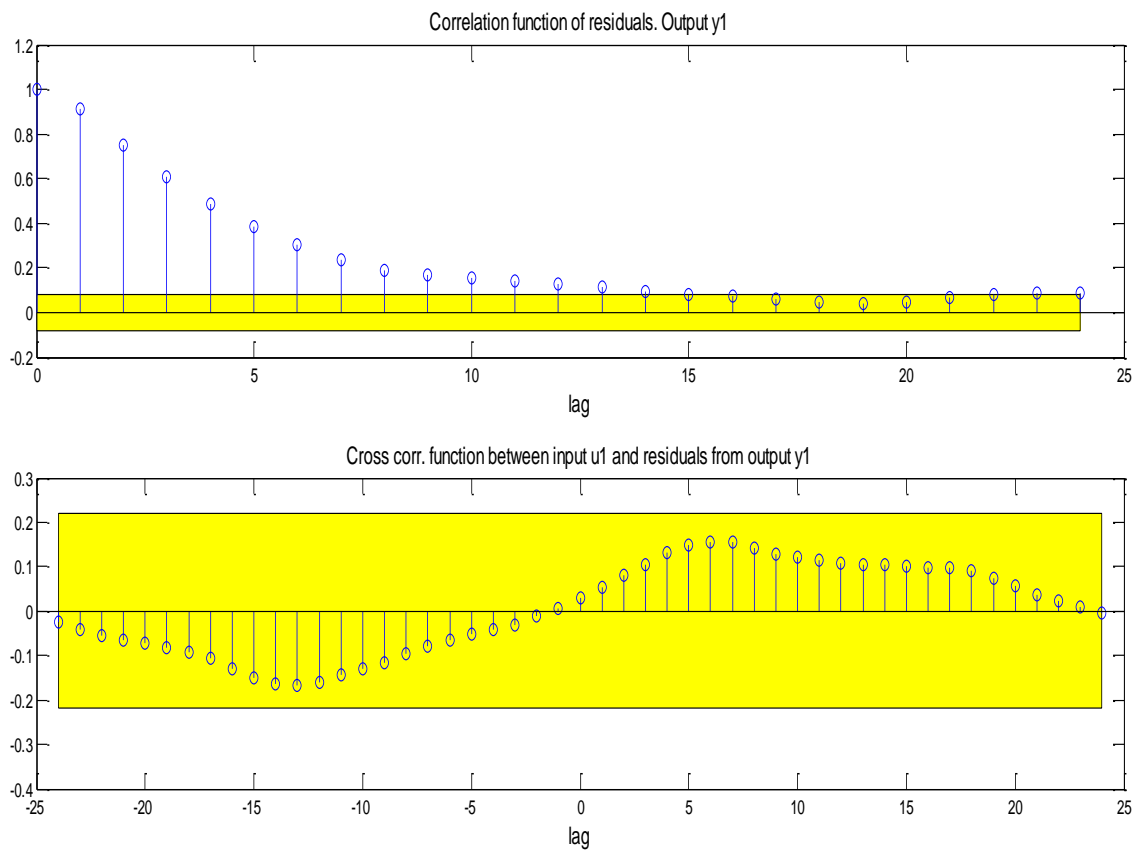

Figure 113: Residual Plot for OE (Second Order-PRBS)

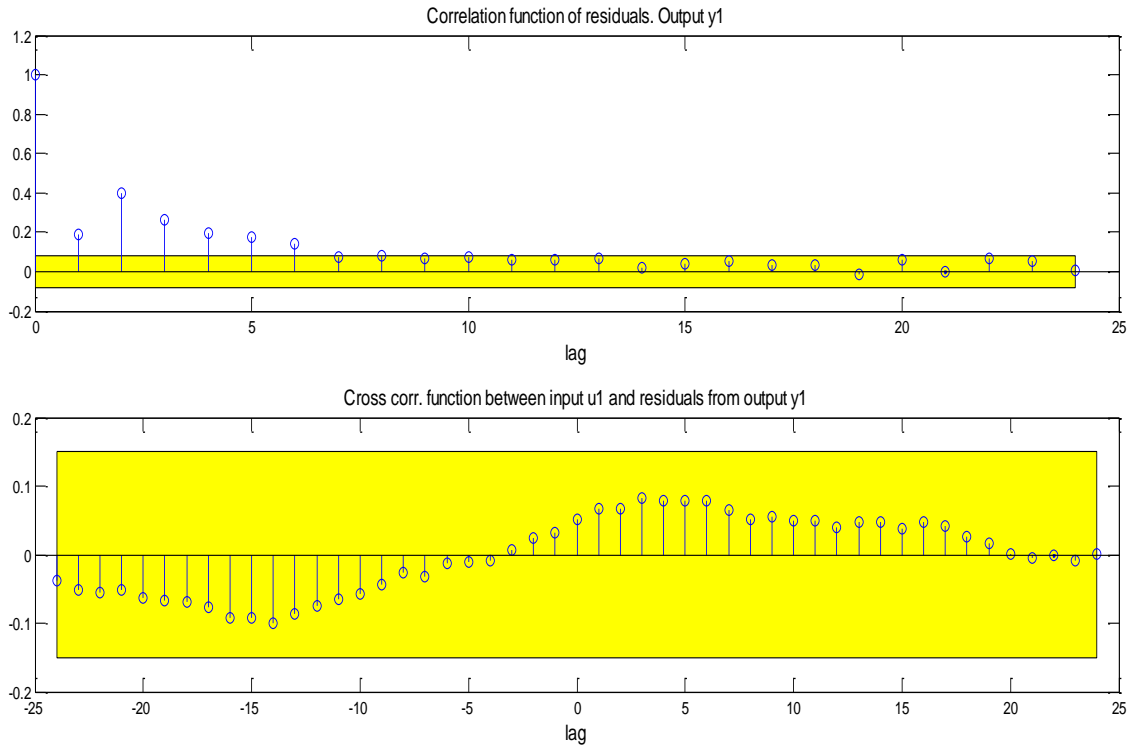

Figure 114: Residual Plot for ARMAX (Second Order-PRBS)

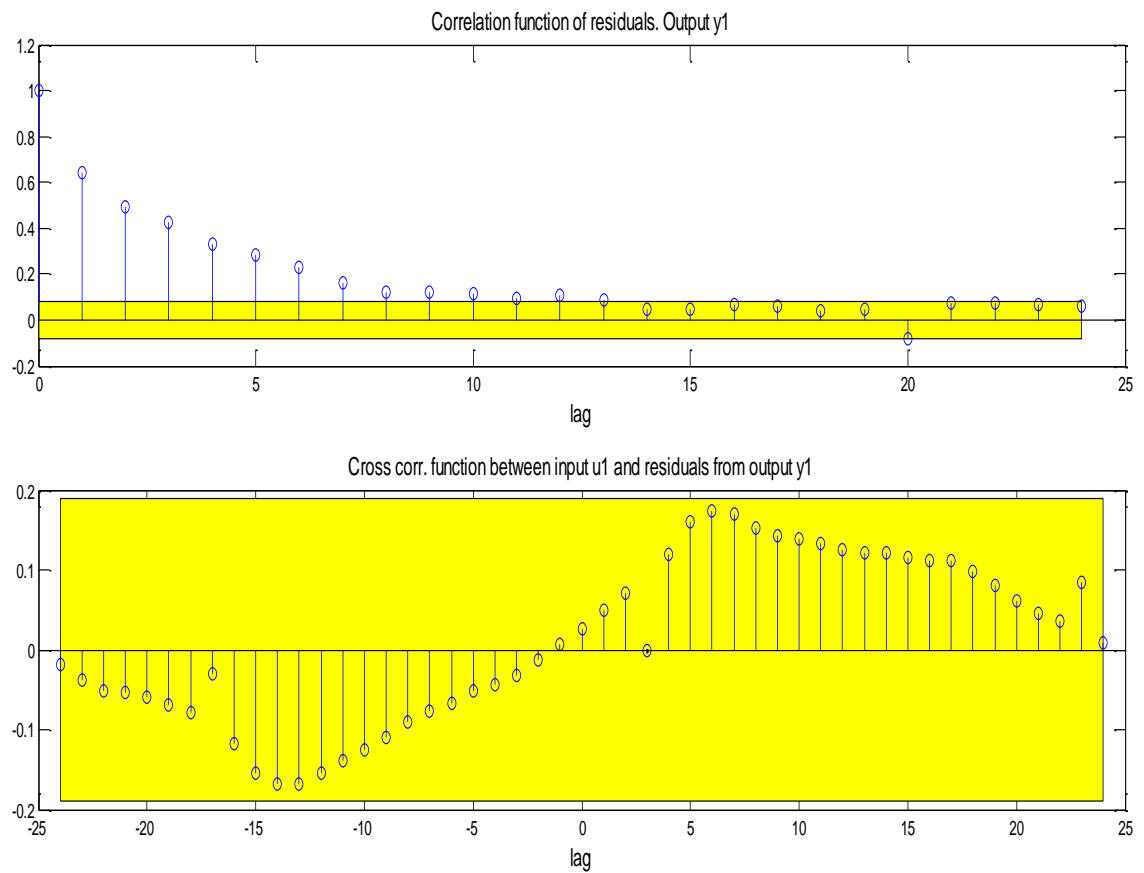

Figure 115: Residual Plot for ARX (Second Order-PRBS)

Case Study 3 (na:3; nb:3; nc:3) (PRBS)

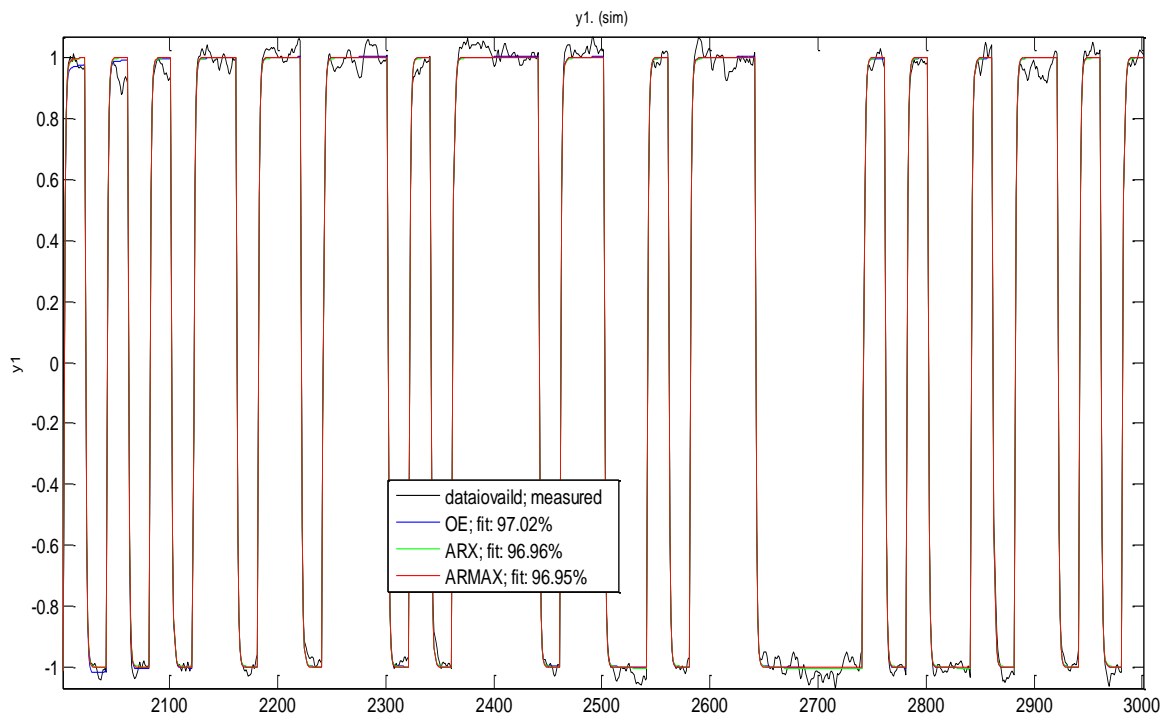

Figure 116: Comparison of model output with the actual measured values (Third Order-PRBS)

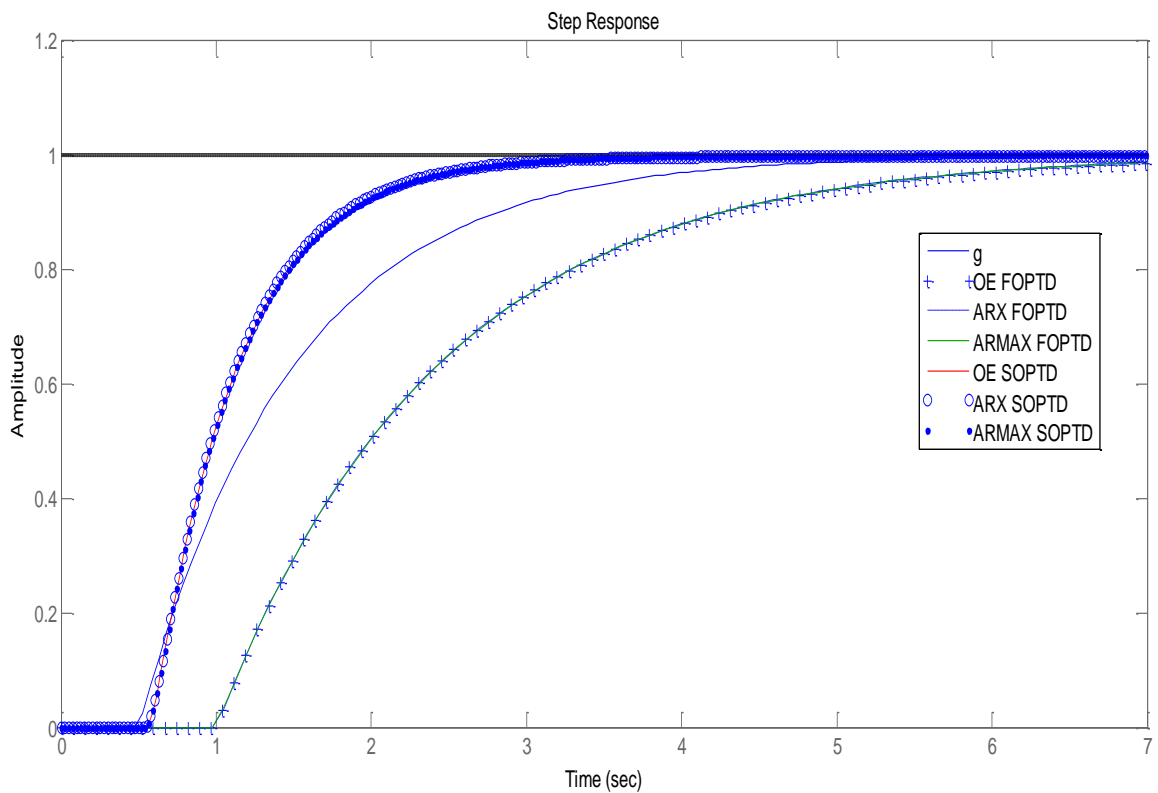

Figure 117: Step response for OE, ARX and ARMAX models (Third Order-PRBS)

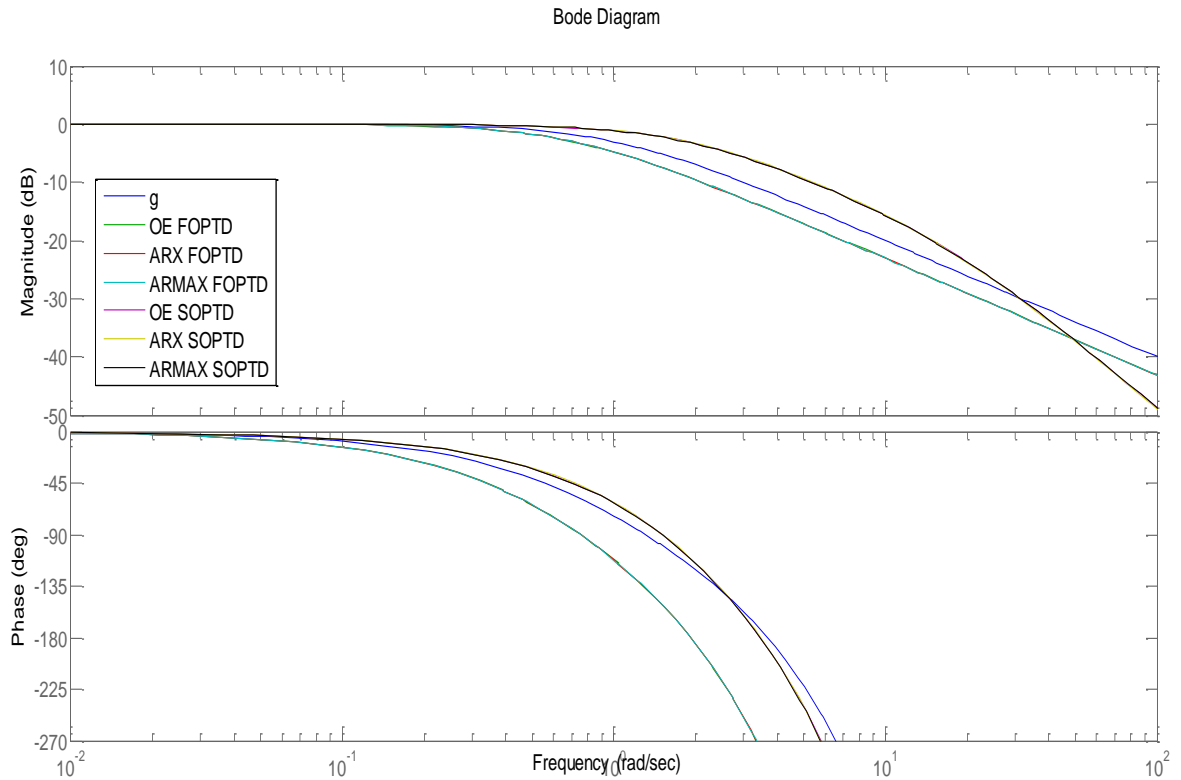

FIGURE 118: BODE PLOT FOR OE, ARX AND ARMAX MODELS (THIRD ORDER-PRBS)

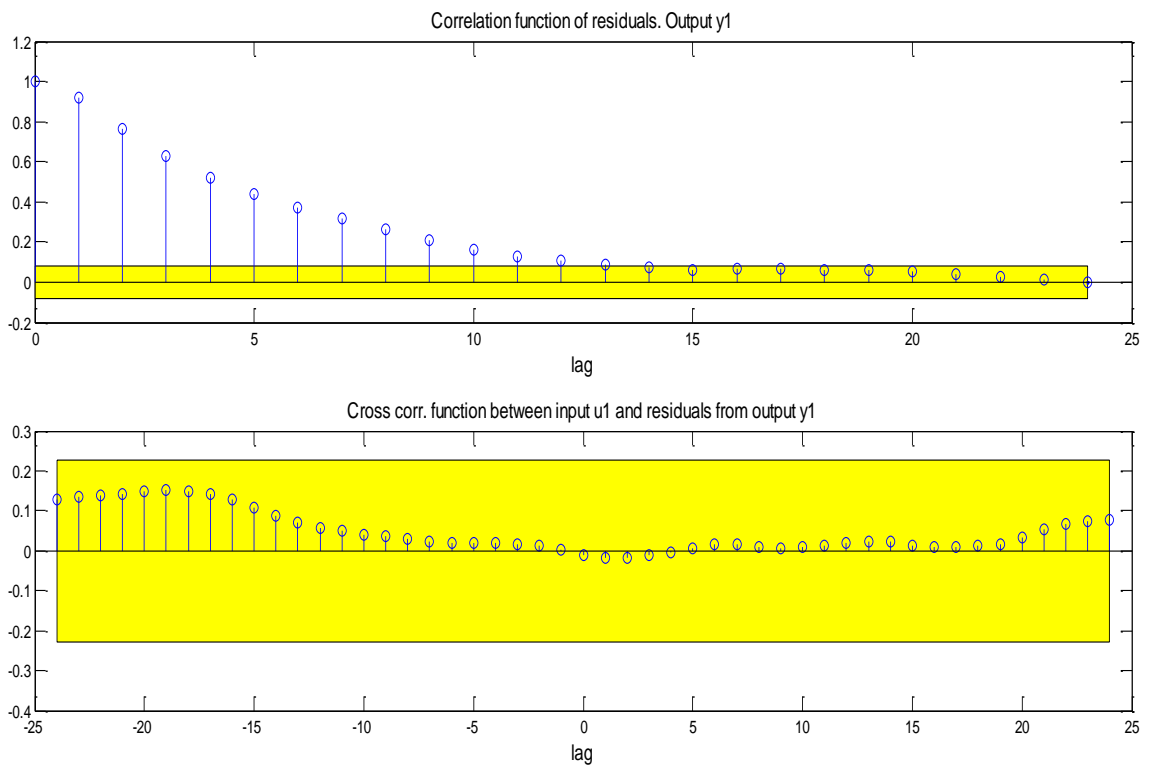

Figure 119: Residual Plot for OE (Third Order-PRBS)

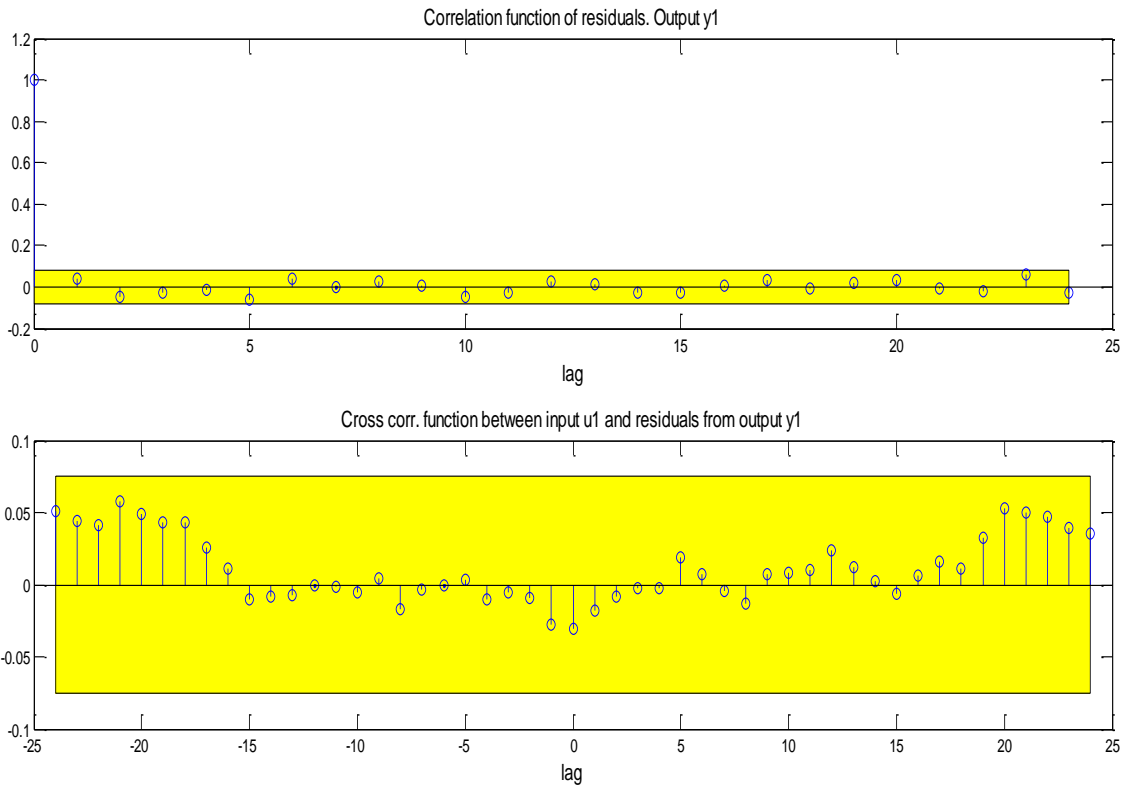

Figure 120: Residual Plot for ARMAX (Third Order-PRBS)

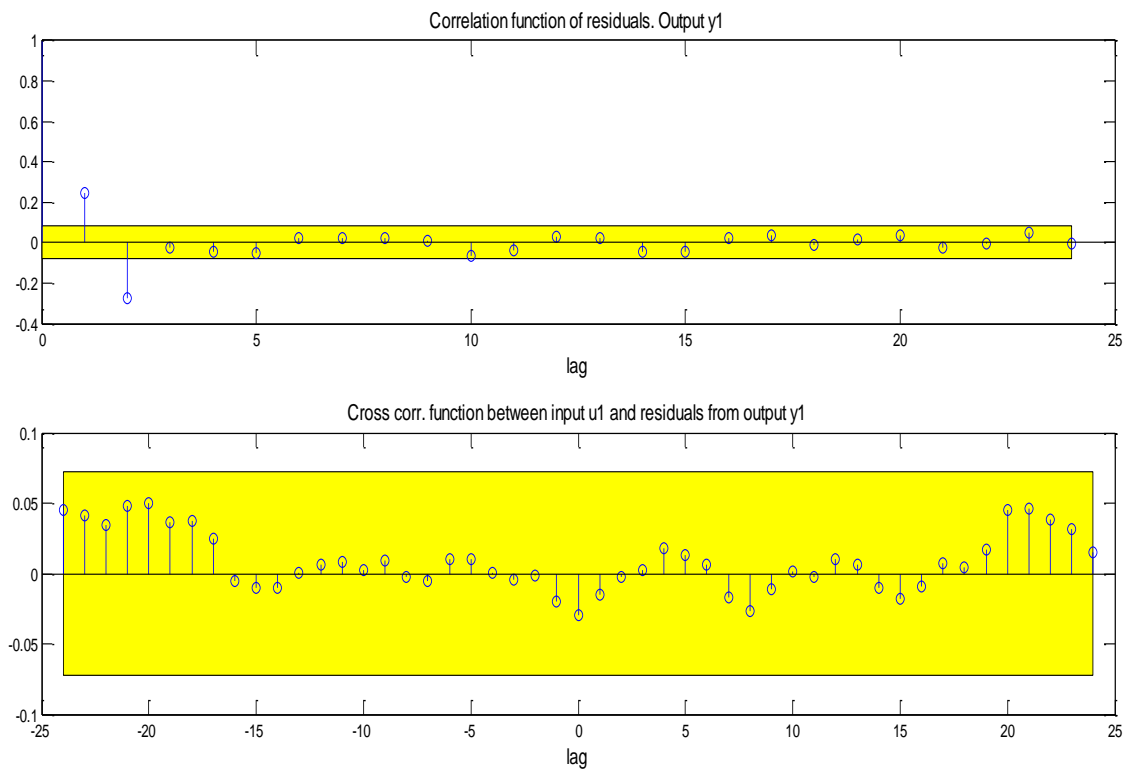

Figure 121: Residual Plot for ARX (Third Order-PRBS)

Case Study 4 (na:4; nb:4; nc:4) (PRBS)

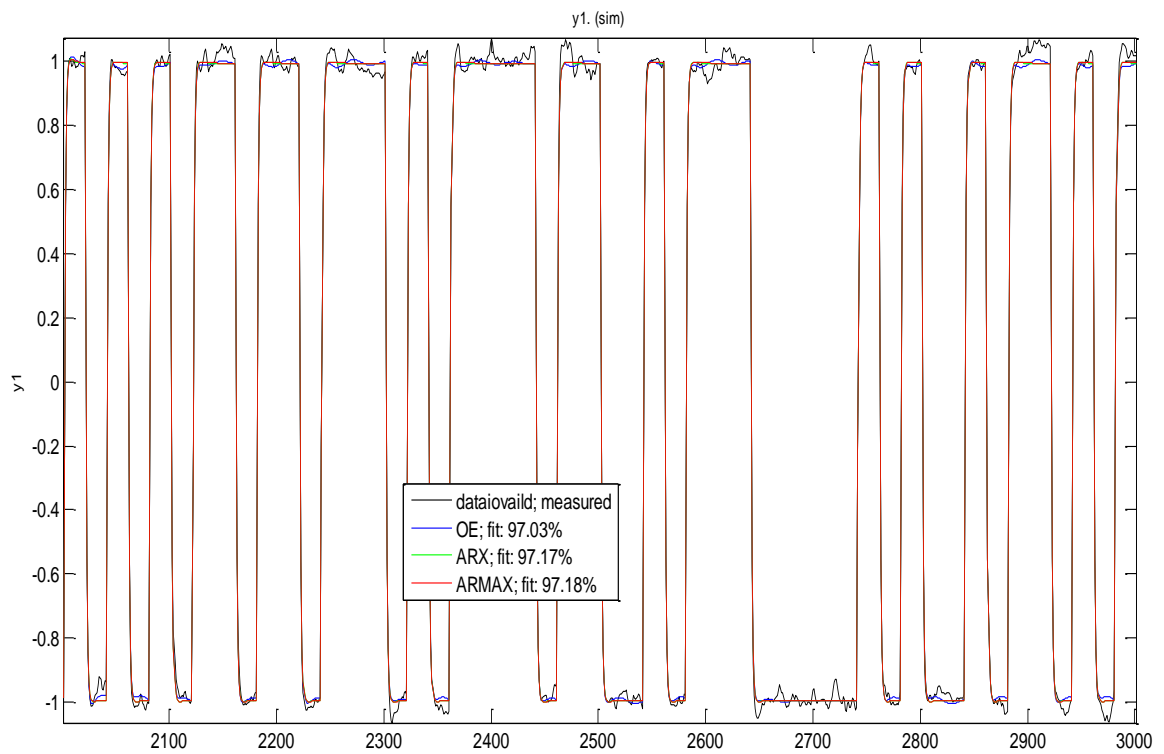

Figure 122: Comparison of model output with the actual measured values (Fourth Order-PRBS)

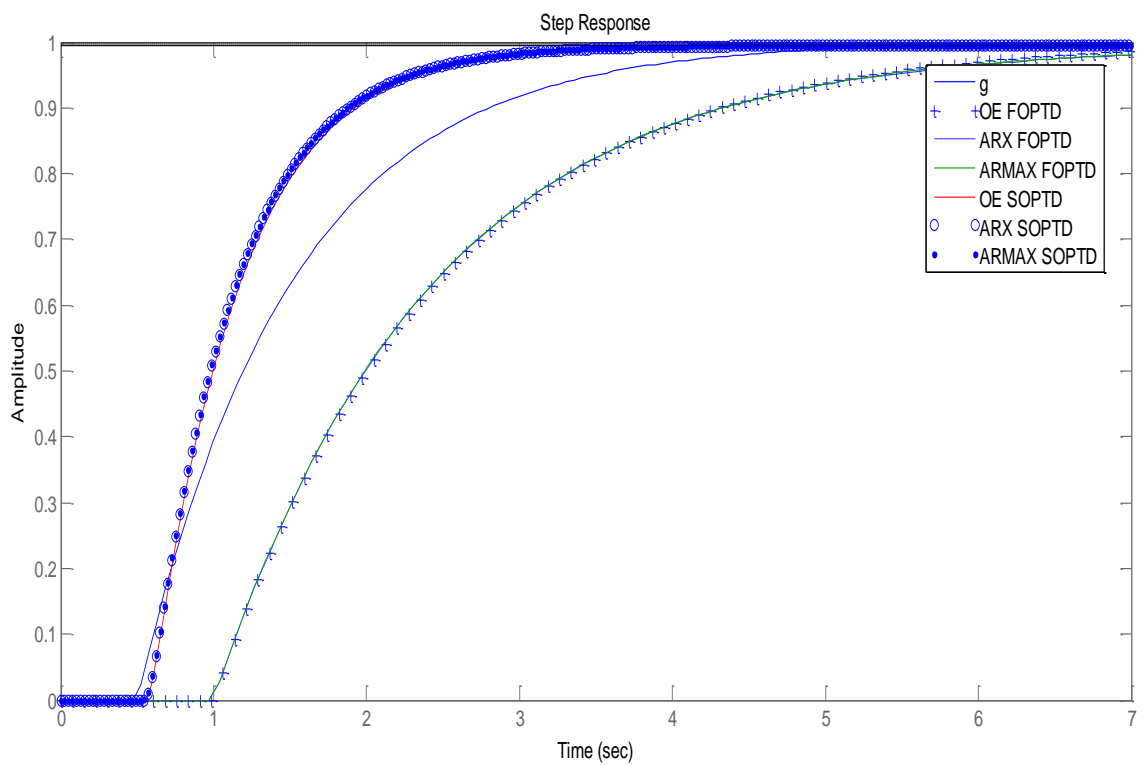

Figure 123: Step response for OE, ARX and ARMAX models (Fourth Order-PRBS)

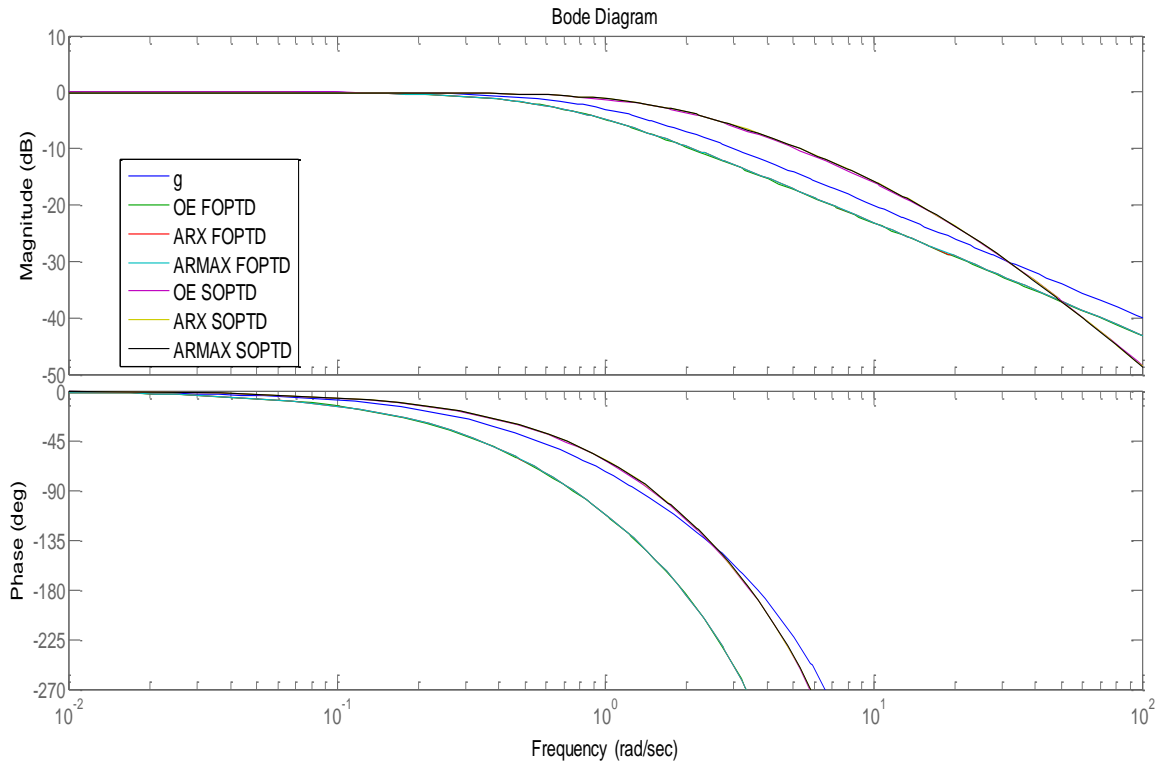

FIGURE 124: BODE PLOT FOR OE, ARX AND ARMAX MODELS (FOURTH ORDER-PRBS)

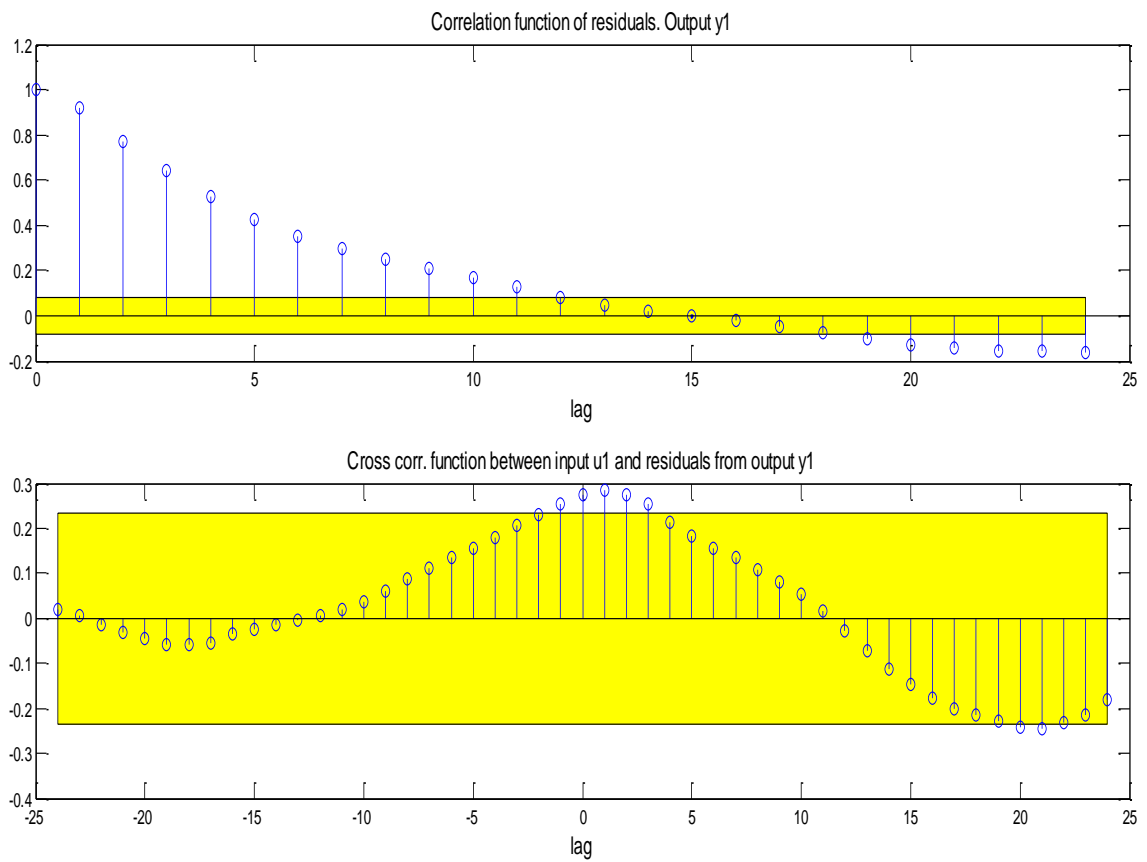

Figure 125: Residual Plot for OE (Fourth Order-PRBS)

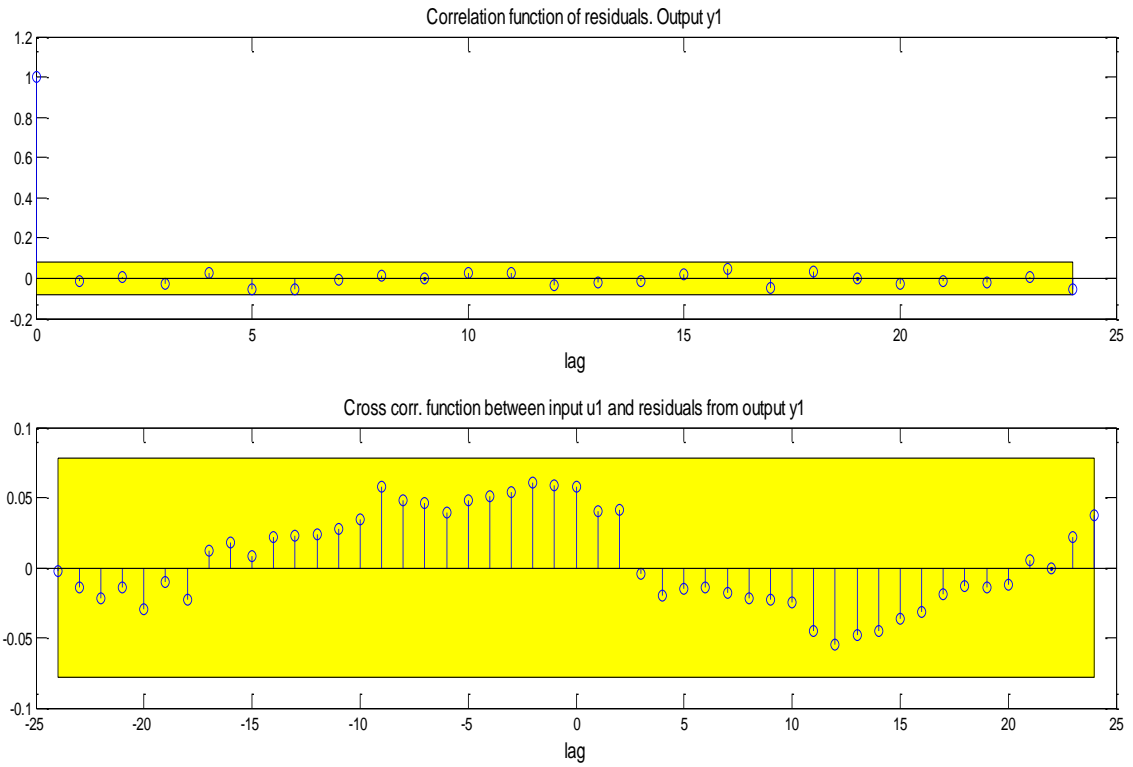

Figure 126: Residual Plot for ARMAX (Fourth Order-PRBS)

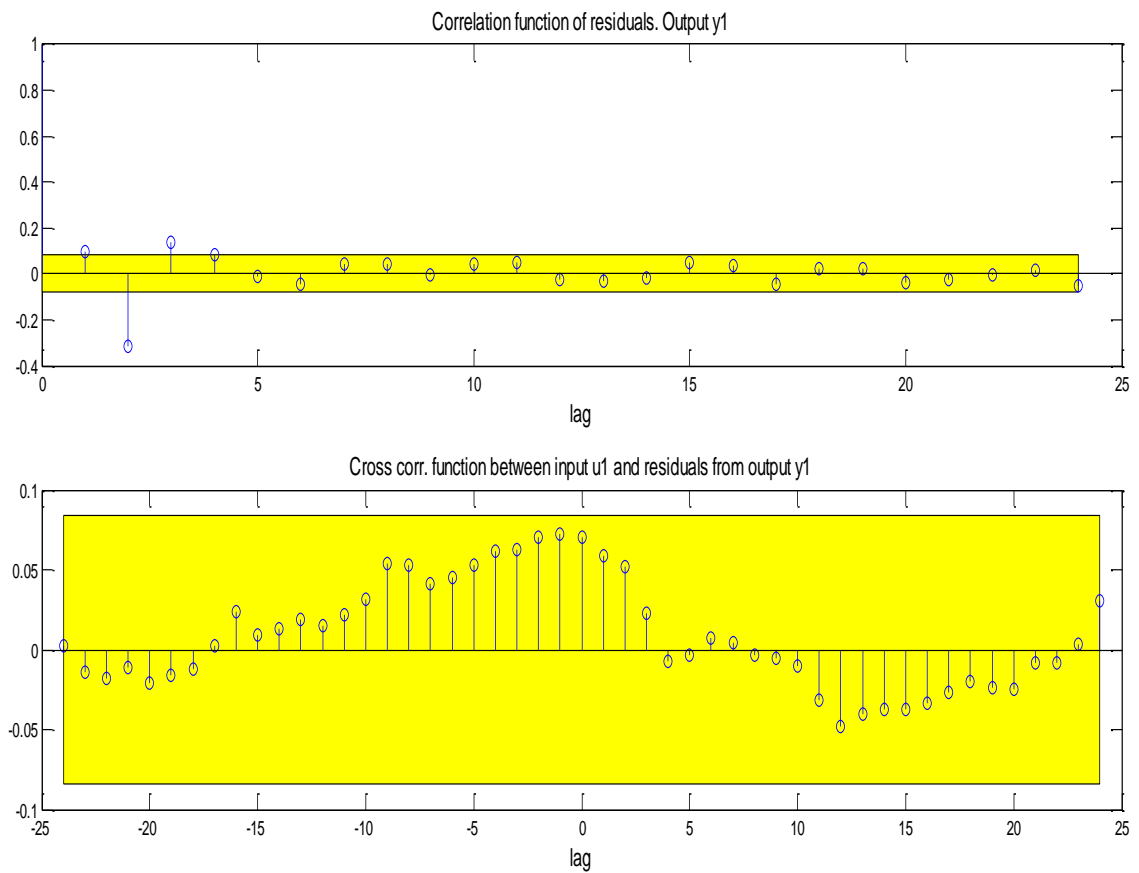

Figure 127: Residual Plot for ARX (Fourth Order-PRBS)

Case Study 5 (na:5; nb:5; nc:5) (PRBS)

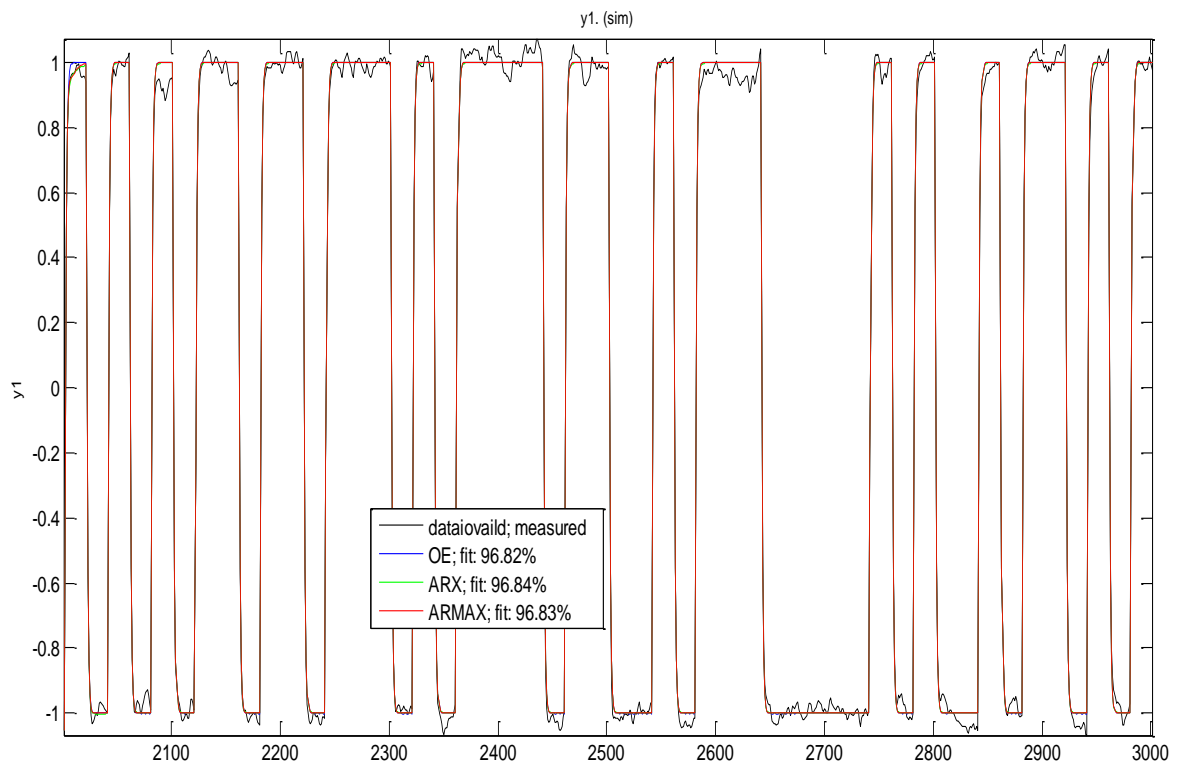

Figure 128: Comparison of model output with the actual measured values (Fifth Order-PRBS)

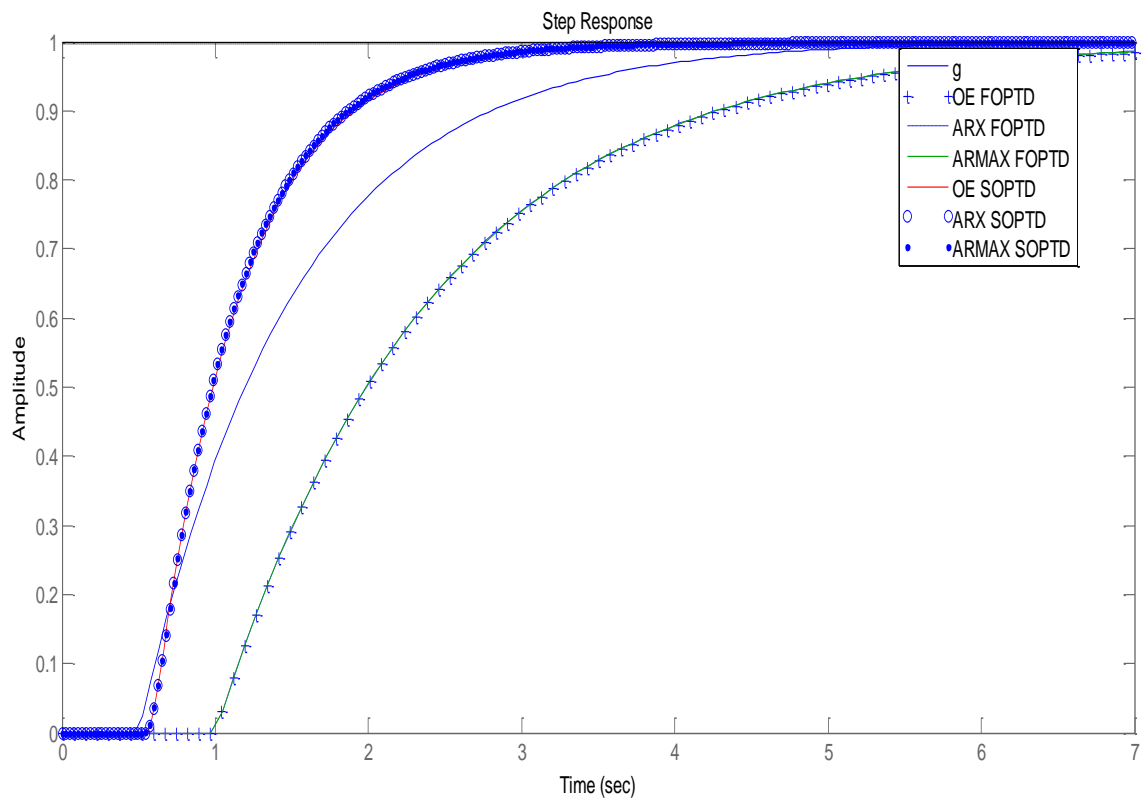

Figure 129: Step response for OE, ARX and ARMAX models (Fourth Order-PRBS)

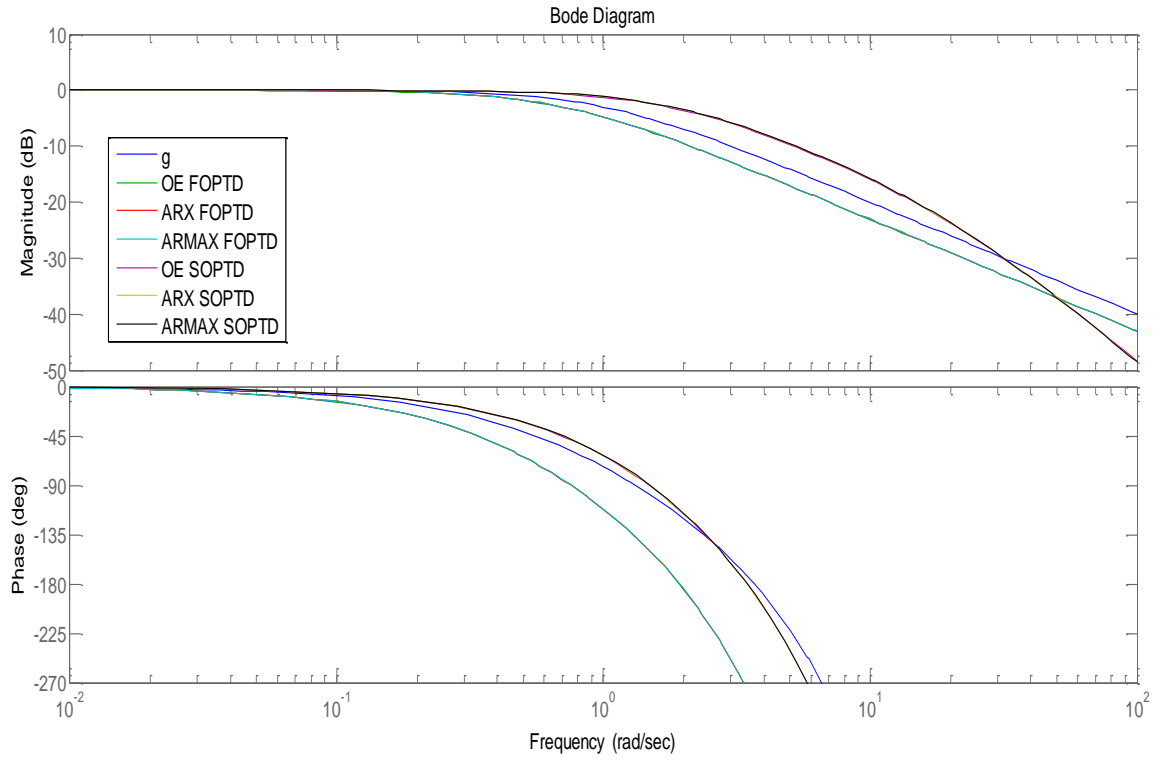

Figure 130: Bode Plot for OE, ARX and ARMAX models (Fifth Order-PRBS)

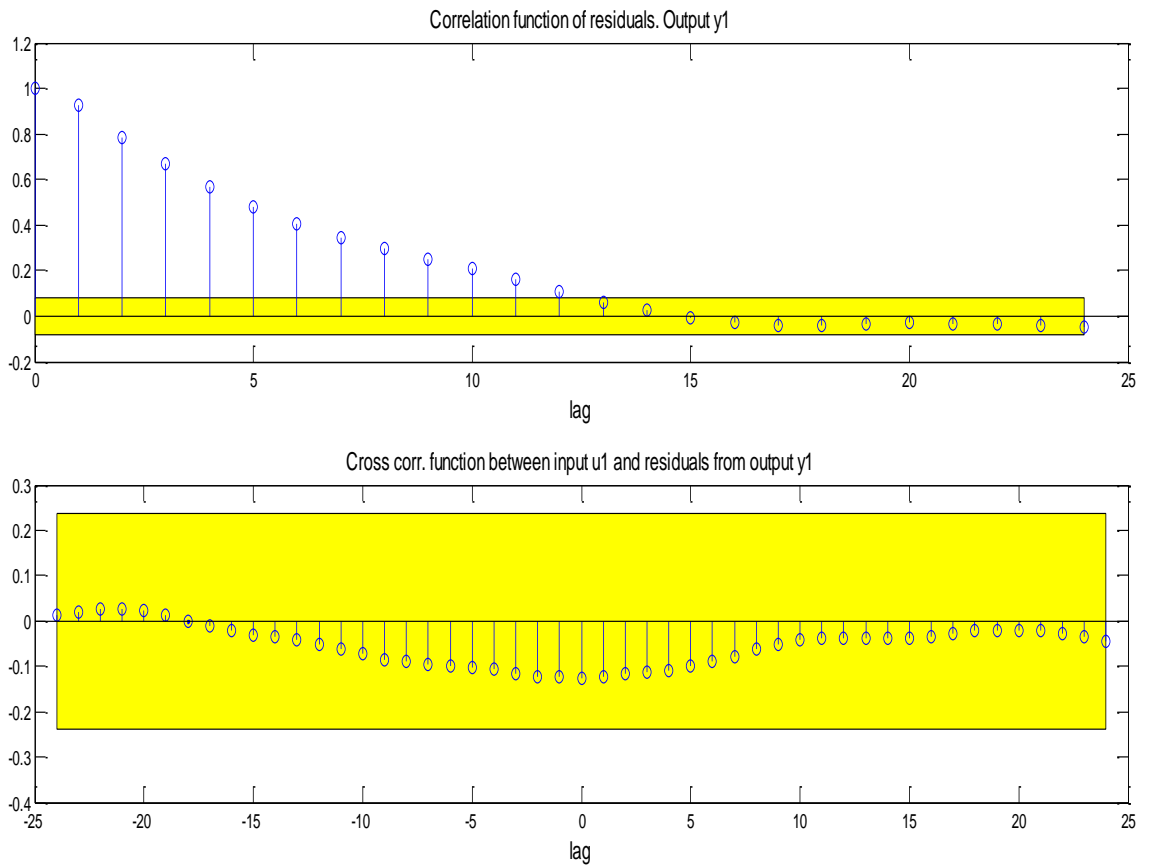

Figure 131: Residual Plot for OE (Fifth Order-PRBS)

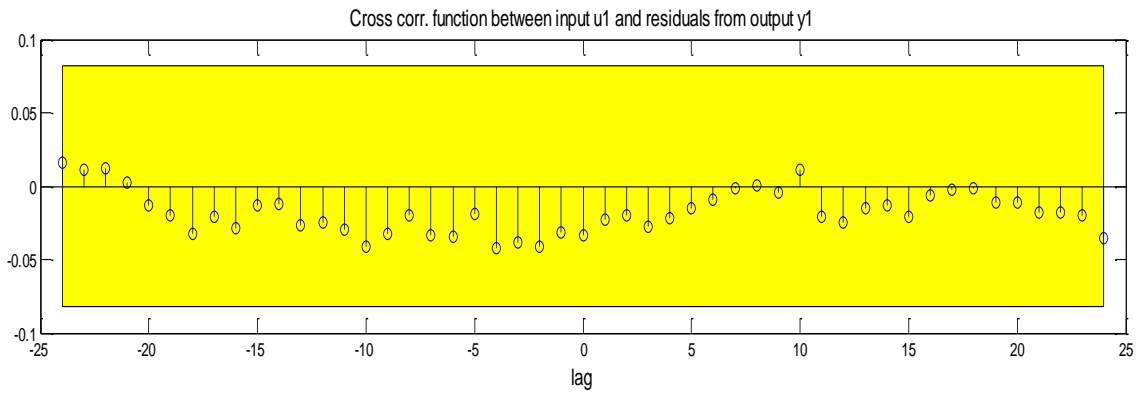
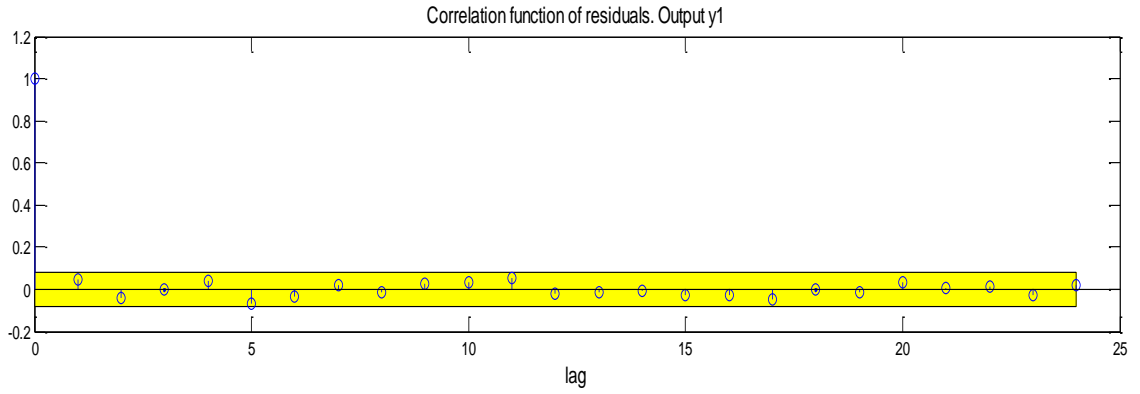

Figure 132: Residual Plot for ARMAX (Fifth Order-PRBS)

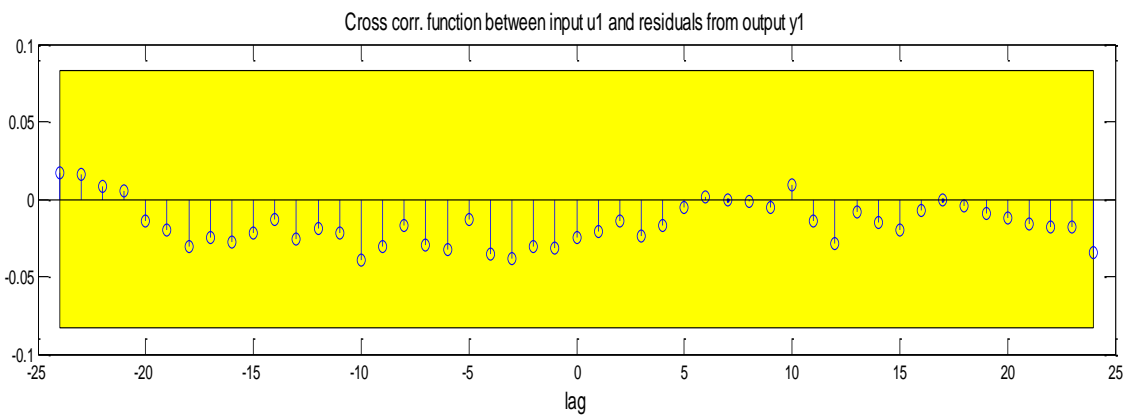
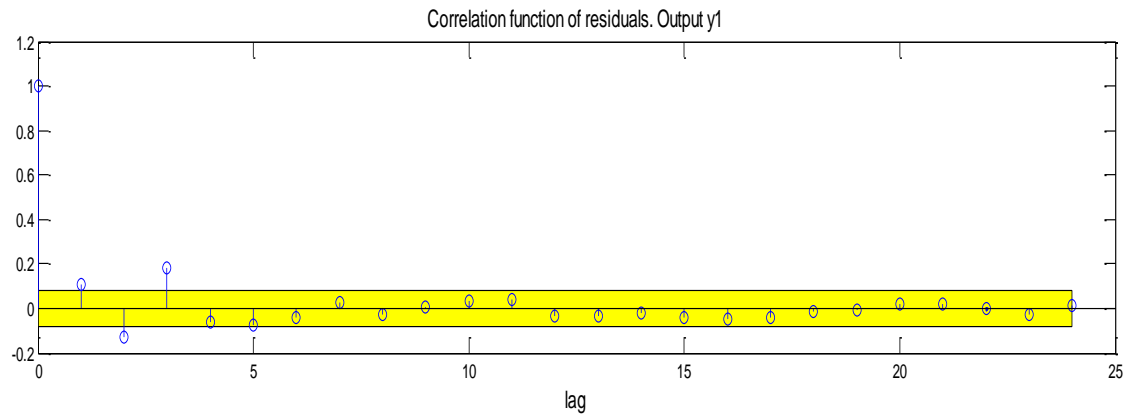

Figure 133: Residual Plot for OE (Fifth Order-PRBS)

Case Study 1 (na:1; nb:1; nc:1) (APRBS)

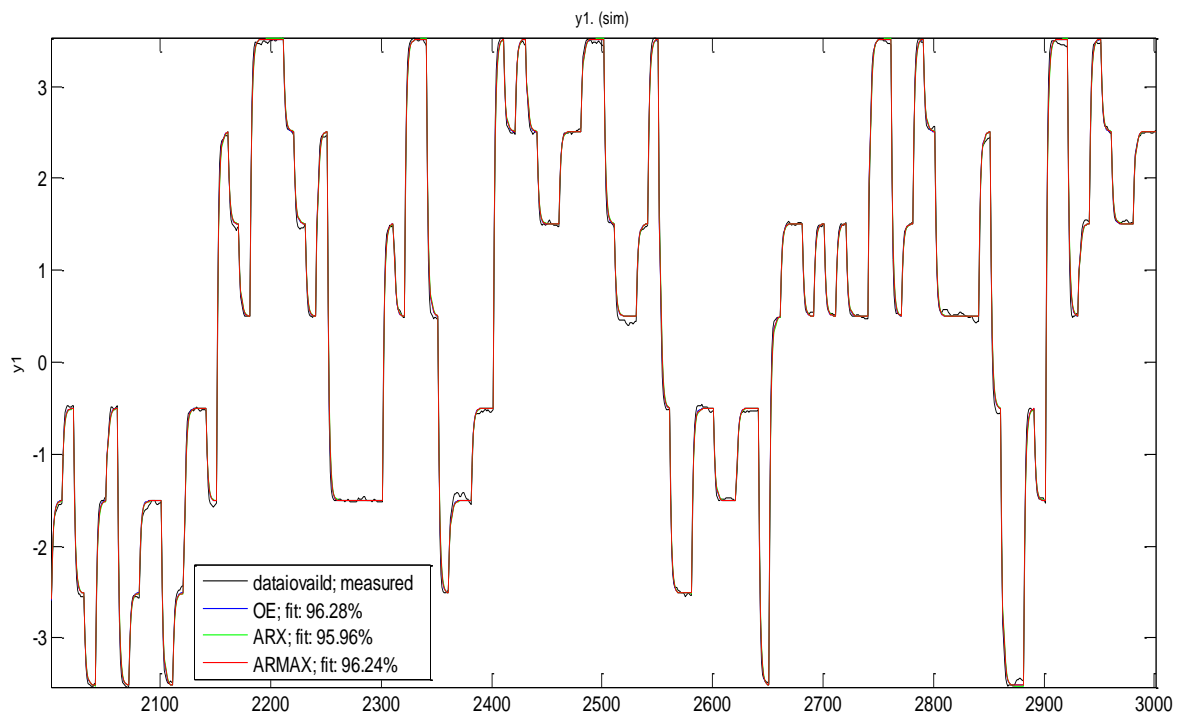

Figure 134: Comparison of model output with the actual measured values (First Order-APRBS)

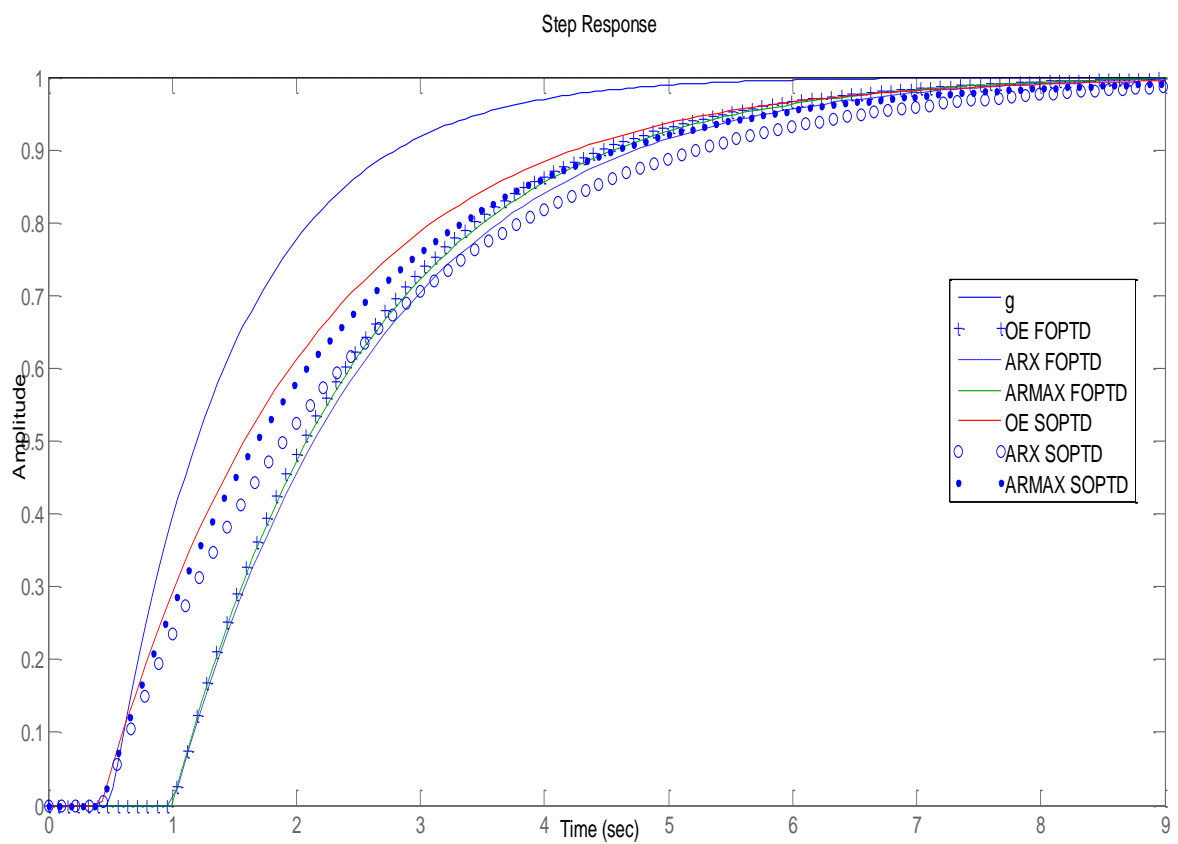

Figure 135: Step response for OE, ARX and ARMAX models (First Order-APRBS)

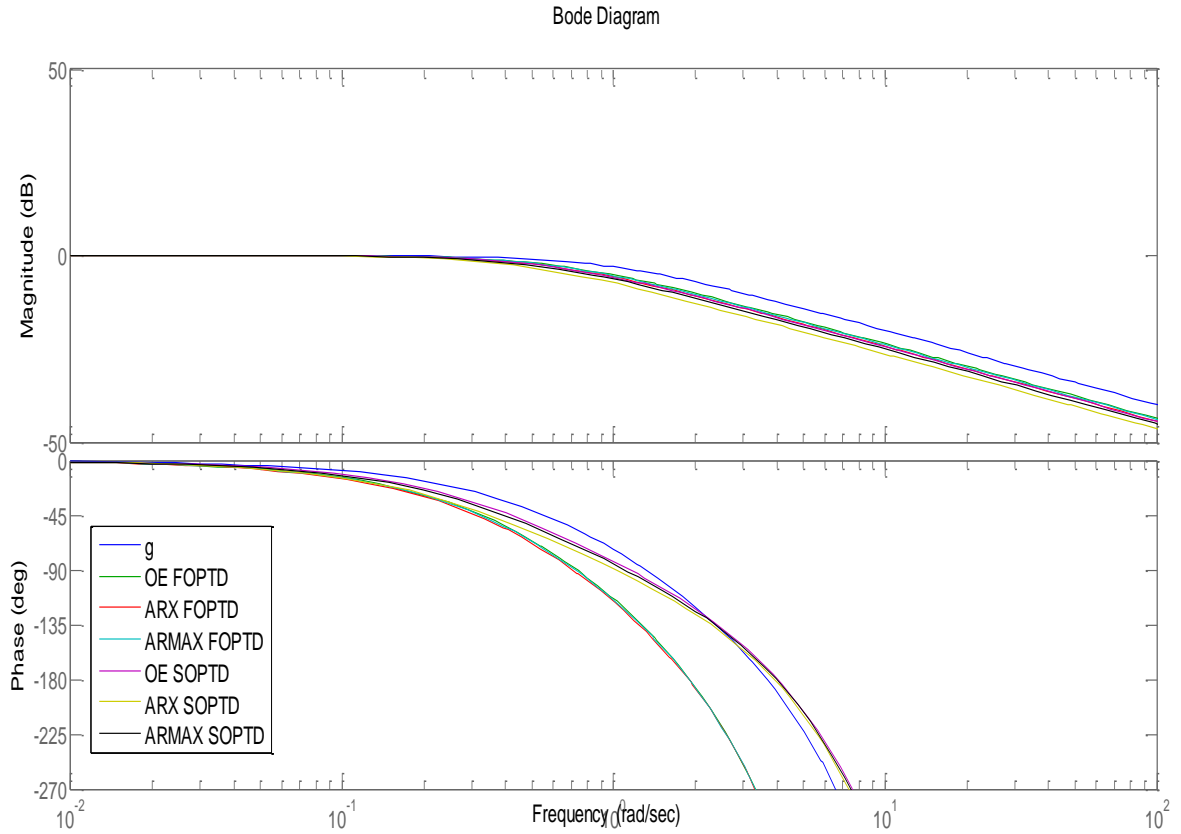

Figure 136: Bode Plot for OE, ARX and ARMAX models (First Order-APRBS)

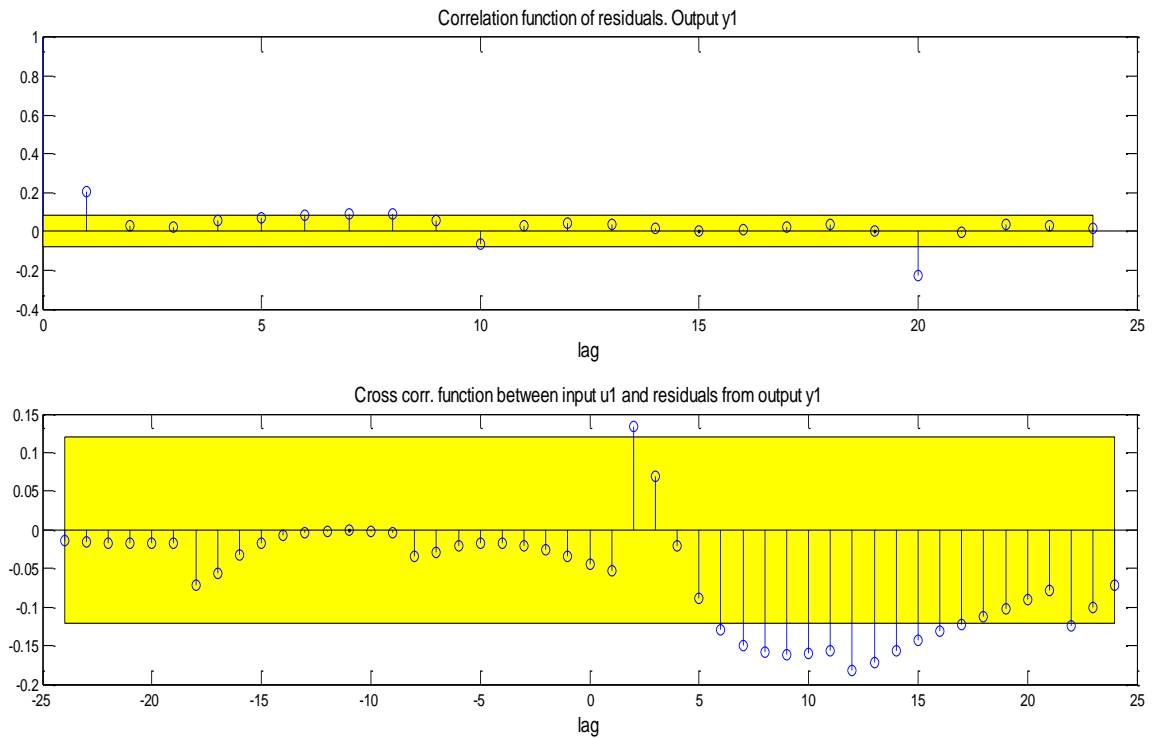

Figure 137: Residual Plot for OE (First Order-APRBS)

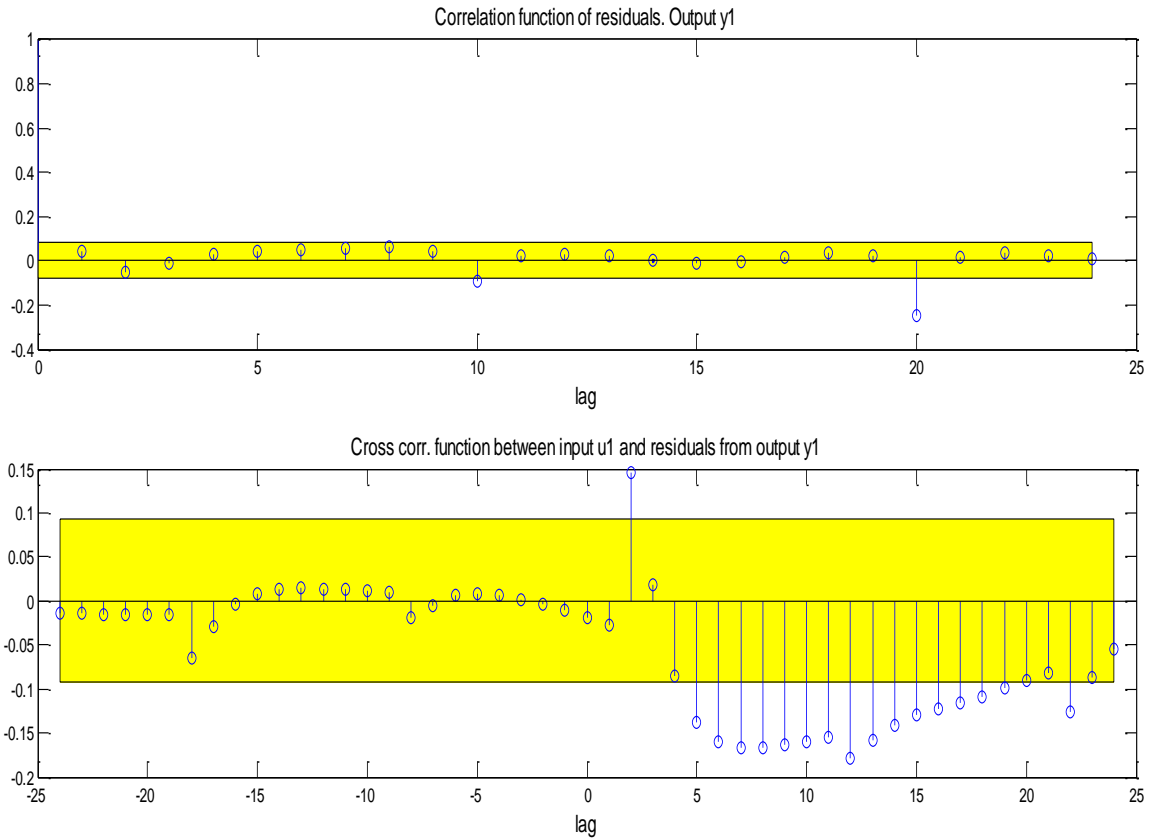

Figure 138: Residual Plot for ARMAX (First Order-APRBS)

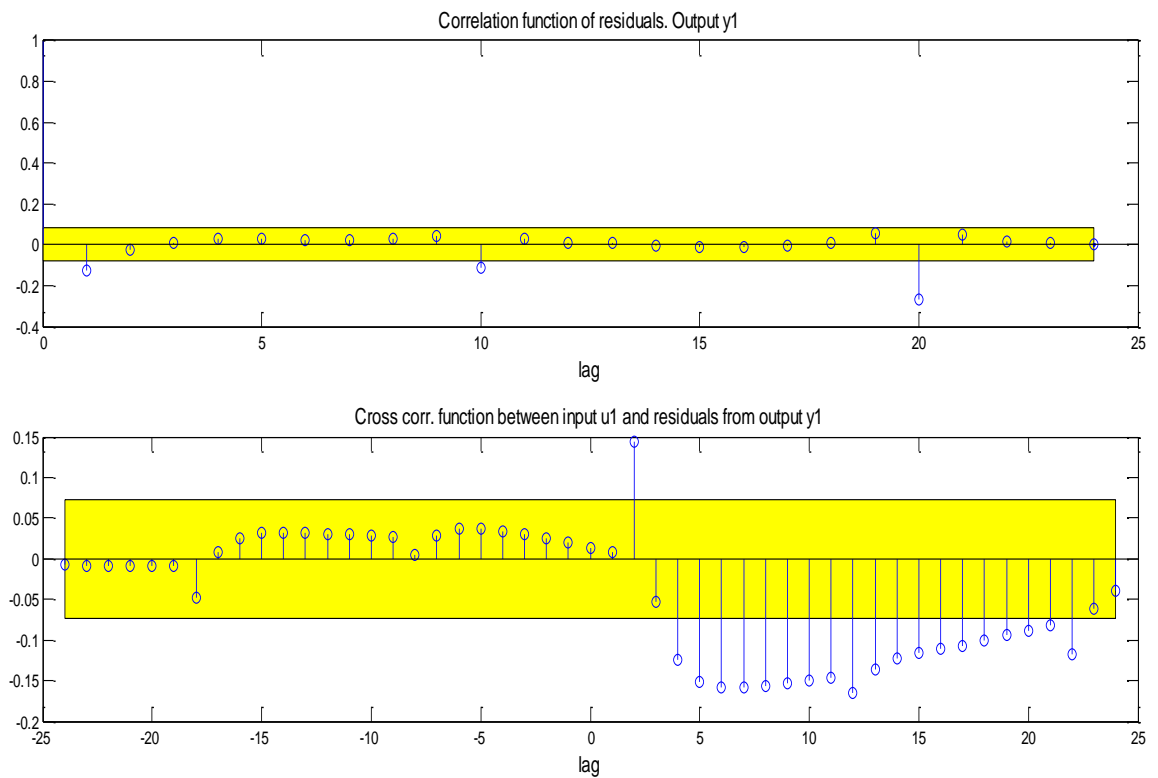

Figure 139: Residual Plot for ARX (First Order-APRBS)

Case Study 2 (na:2; nb:2; nc:2) (APRBS)

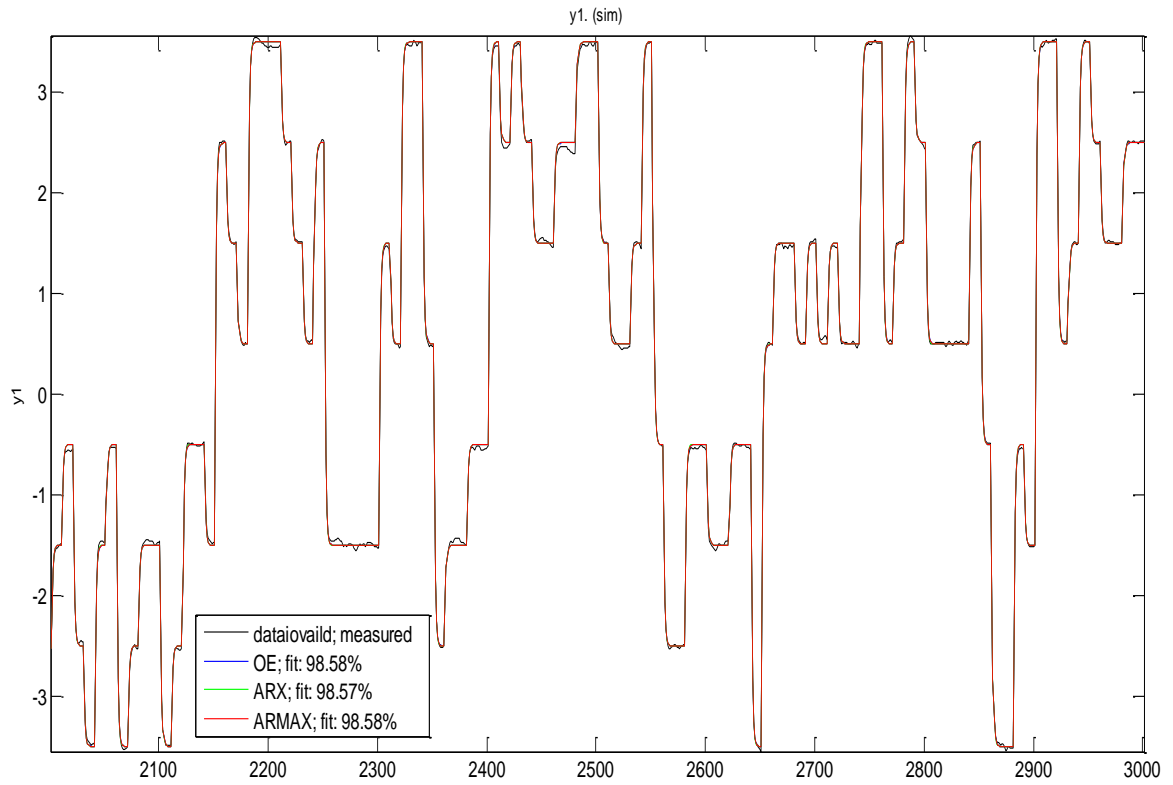

Figure 140: Comparison of model output with the actual measured values (Second Order-APRBS)

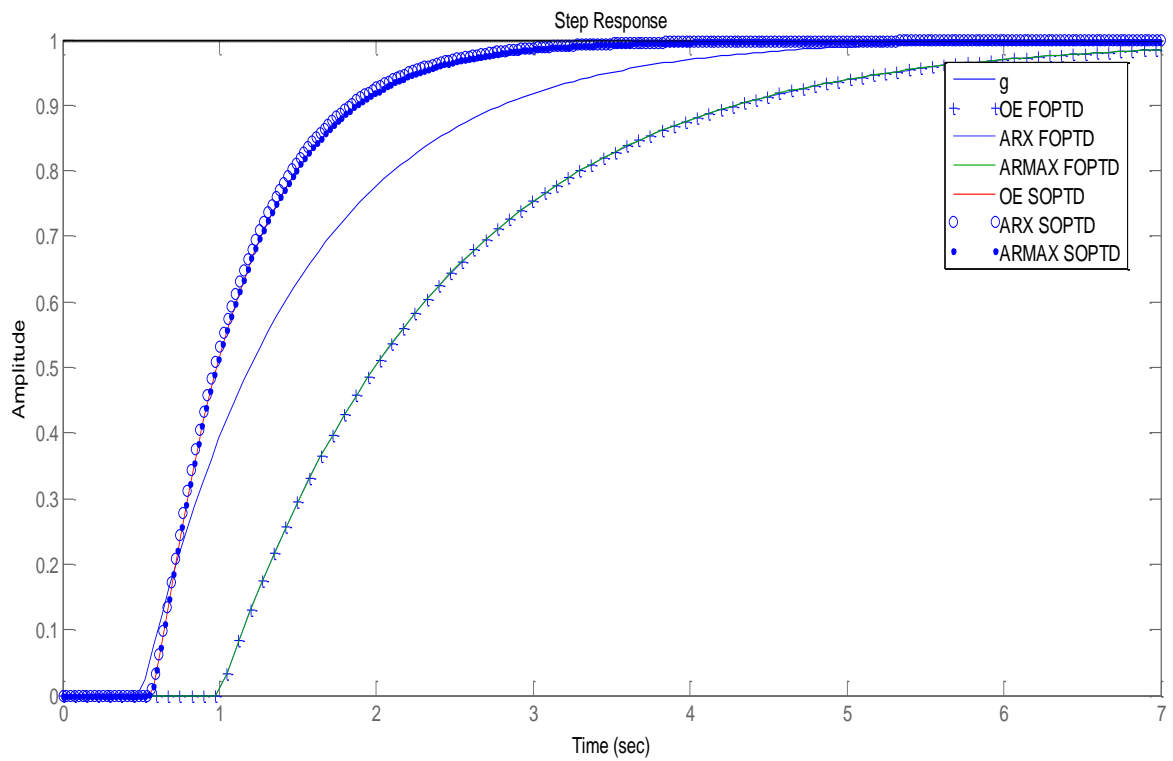

Figure 141: Step response for OE, ARX and ARMAX models (Second Order-APRBS)

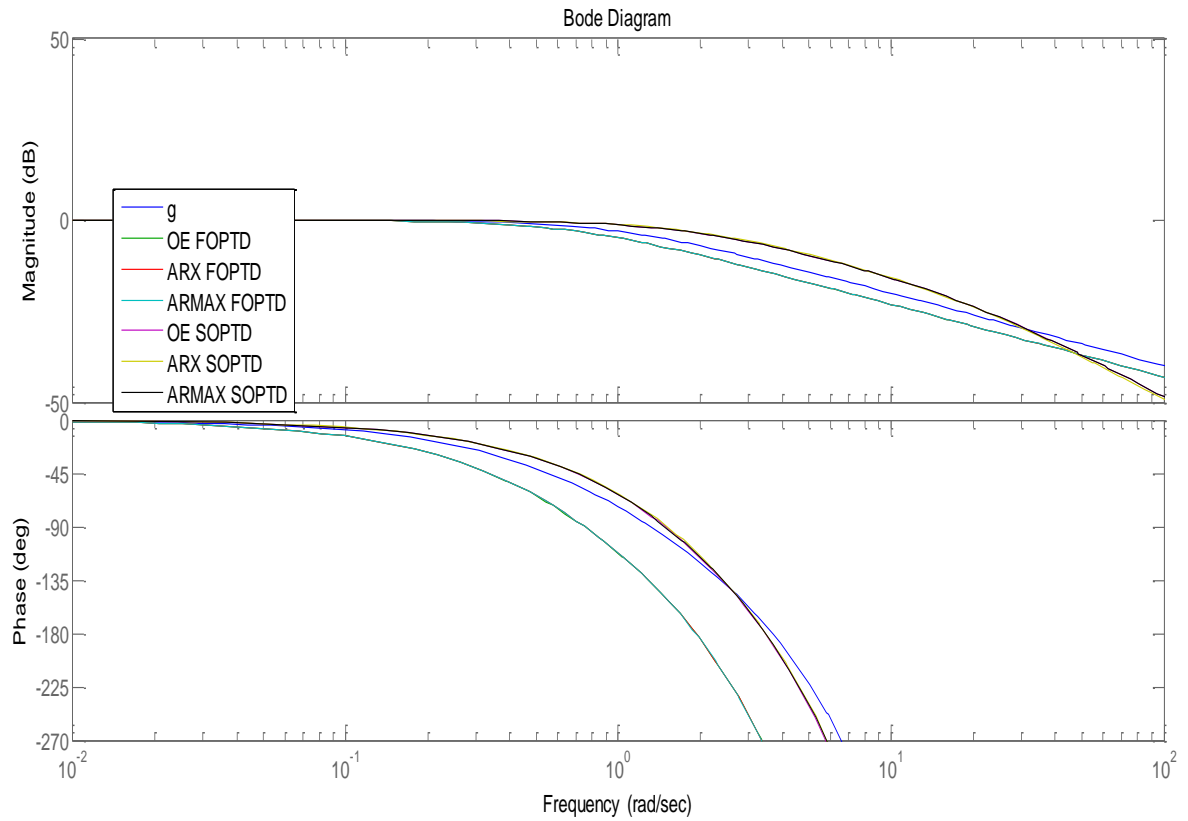

Figure 142: Bode Plot for OE, ARX and ARMAX models (Second Order-APRBS)

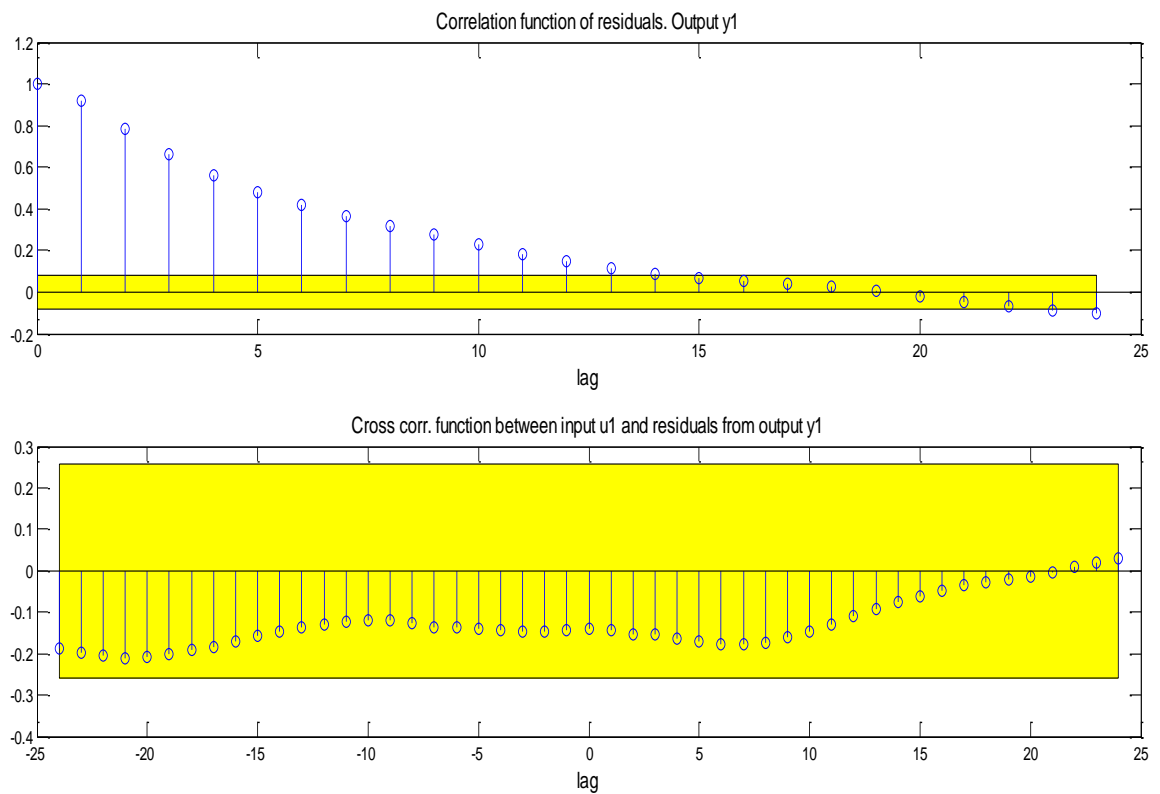

Figure 143: Residual Plot for OE (Second Order-APRBS)

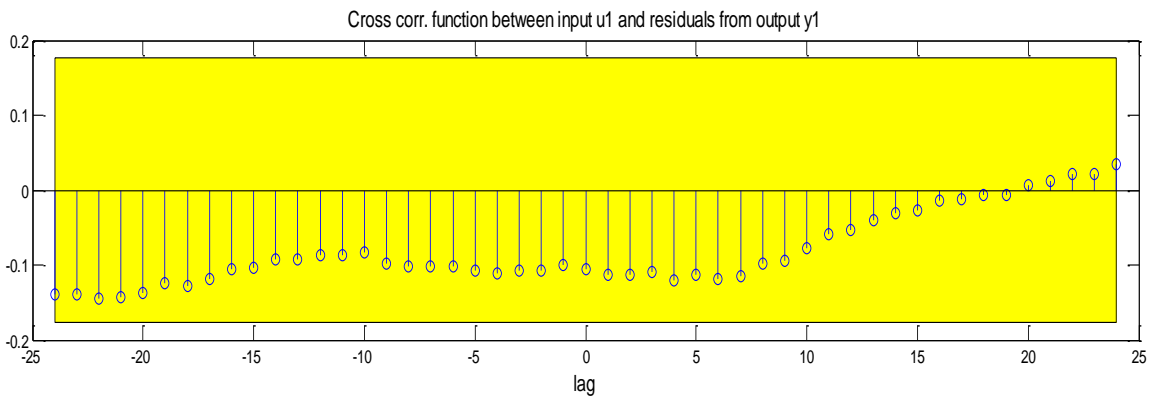
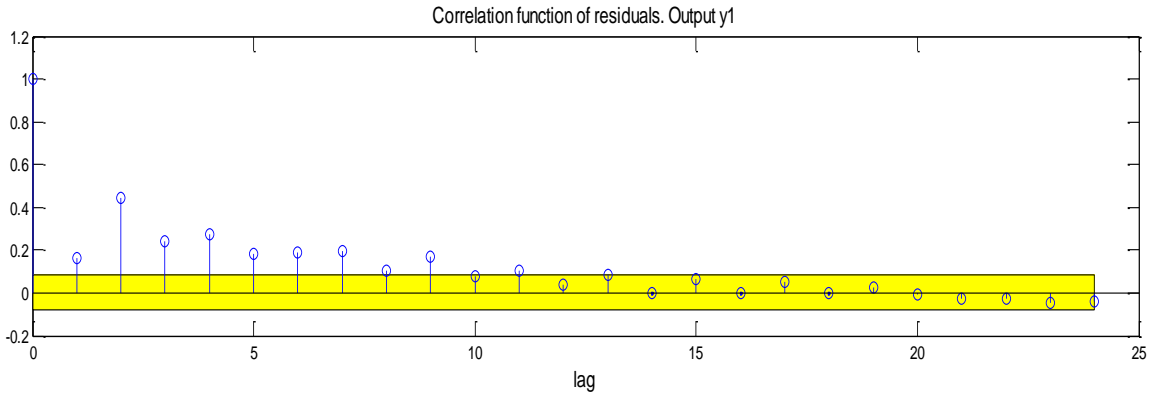

Figure 144: Residual Plot for ARMAX (Second Order-APRBS)

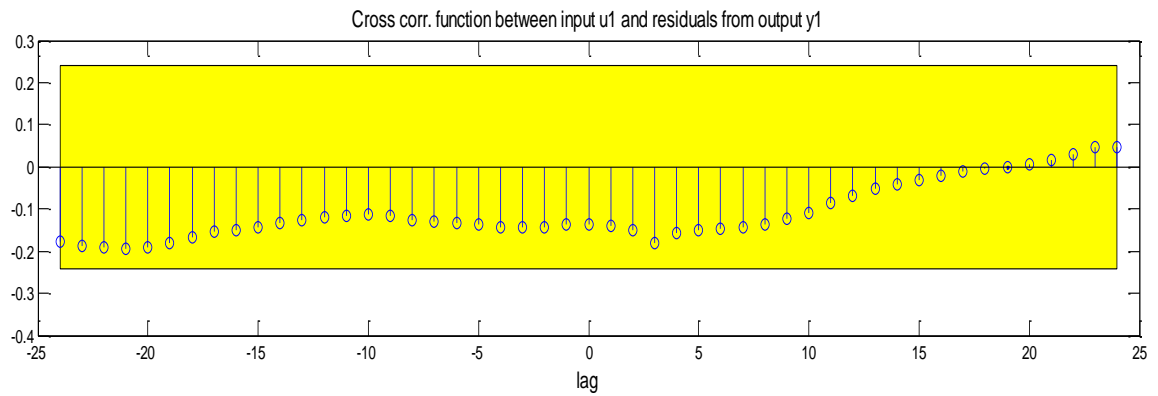
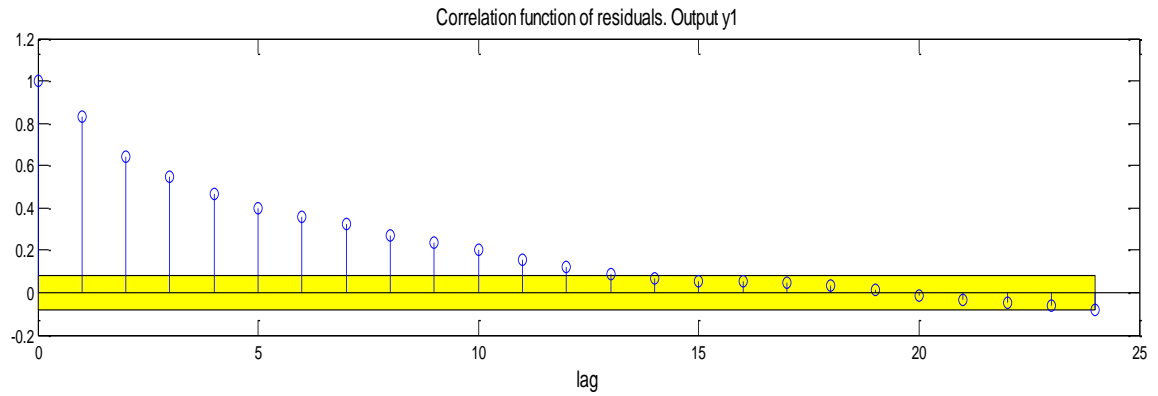

Figure 145: Residual Plot for ARX (Second Order-APRBS)

Case Study 3 (na:3; nb:3; nc:3) (APRBS)

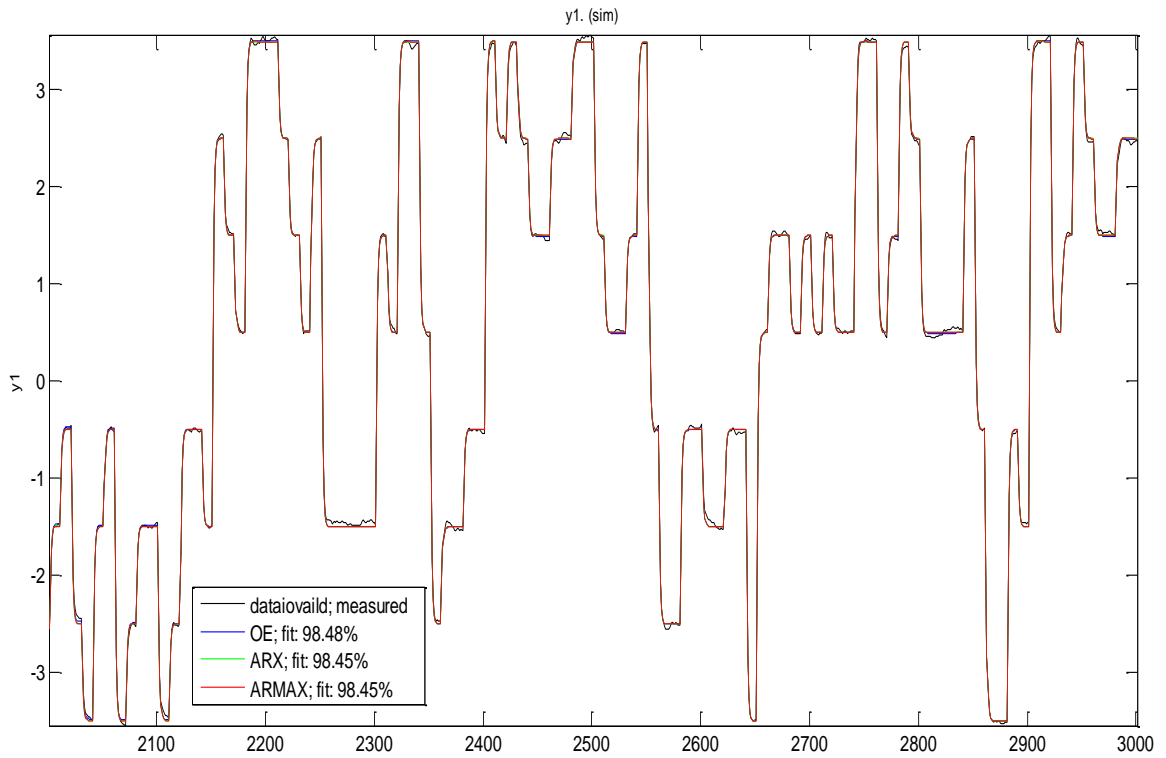

Figure 146: Comparison of model output with the actual measured values (Third Order-APRBS)

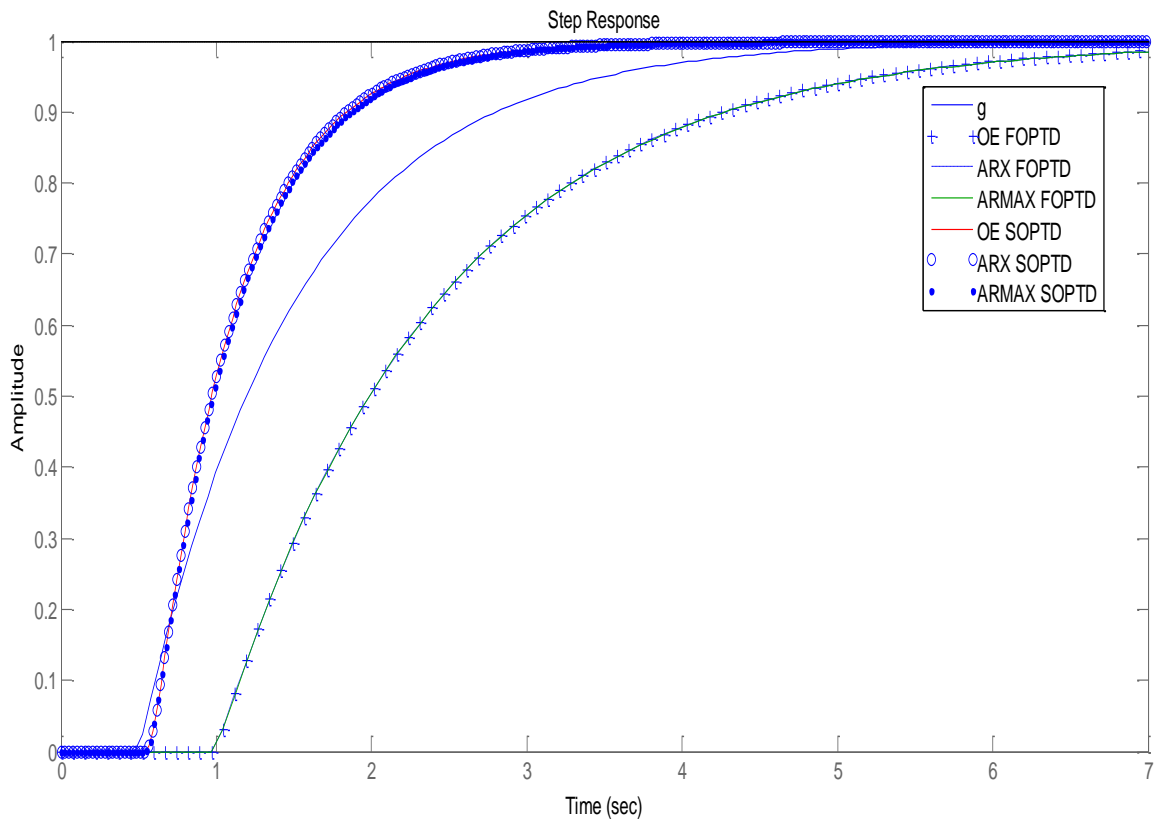

Figure 147: Step response for OE, ARX and ARMAX models (Third Order-APRBS)

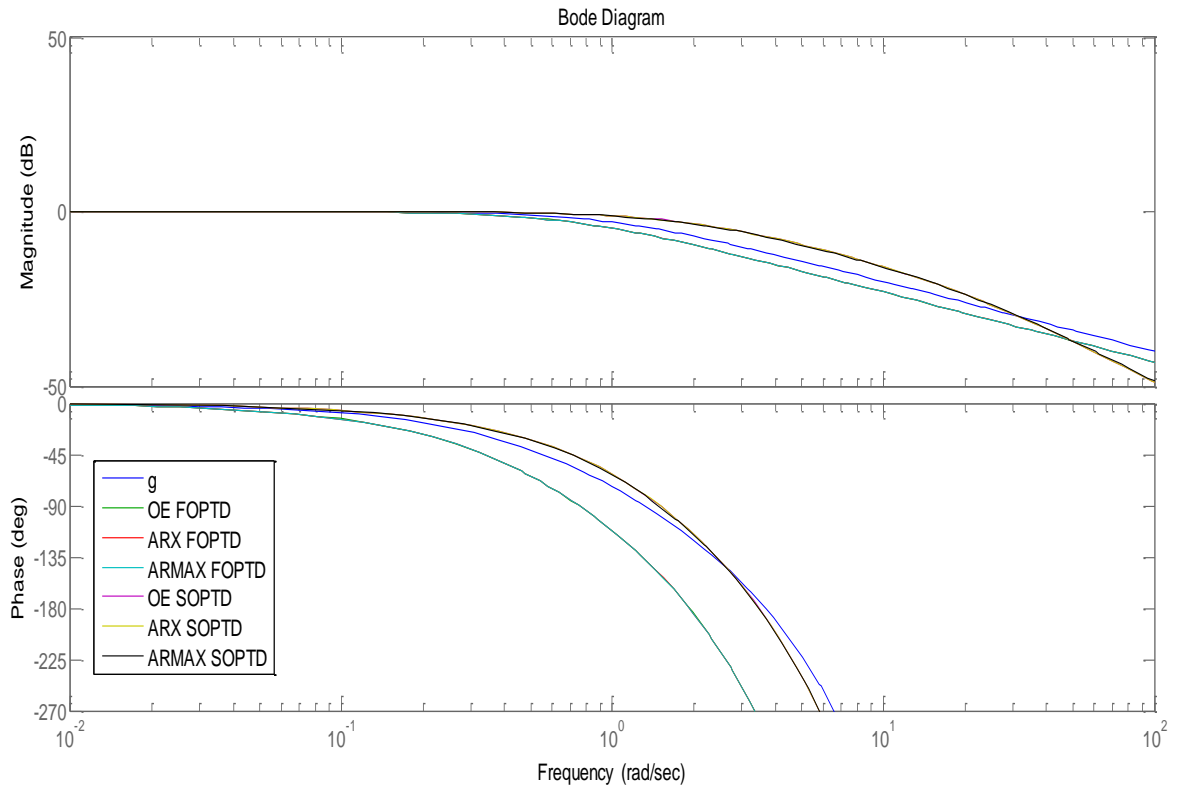

Figure 148: Bode Plot for OE, ARX and ARMAX models (Third Order-APRBS)

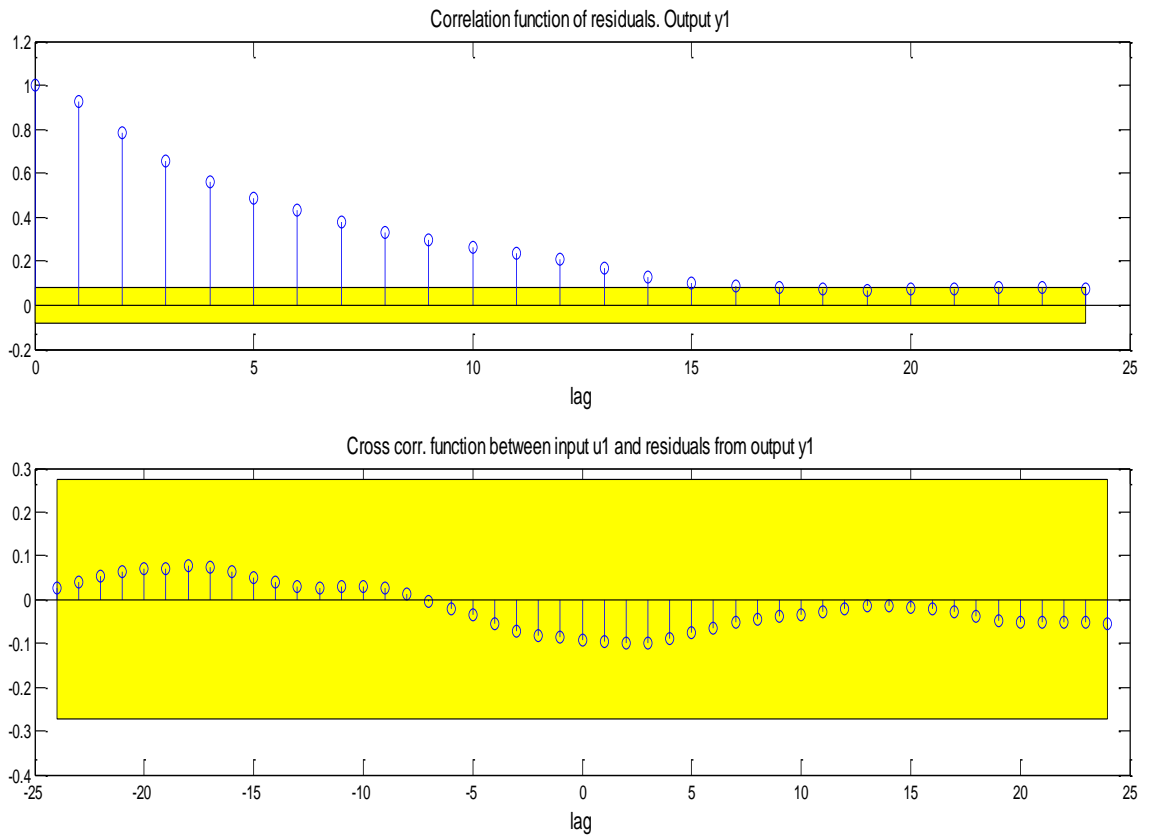

Figure 149: Residual Plot for OE (Third Order-APRBS)

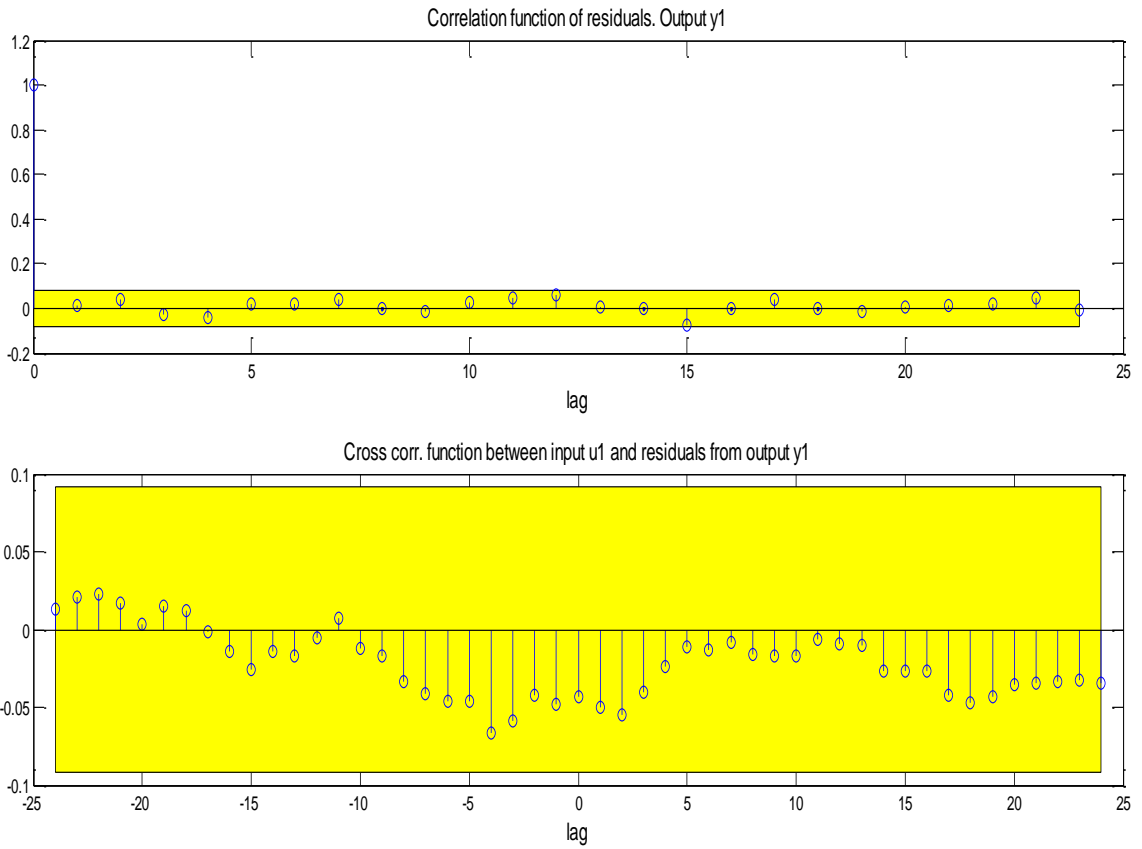

Figure 150: Residual Plot for ARMAX (Third Order-APRBS)

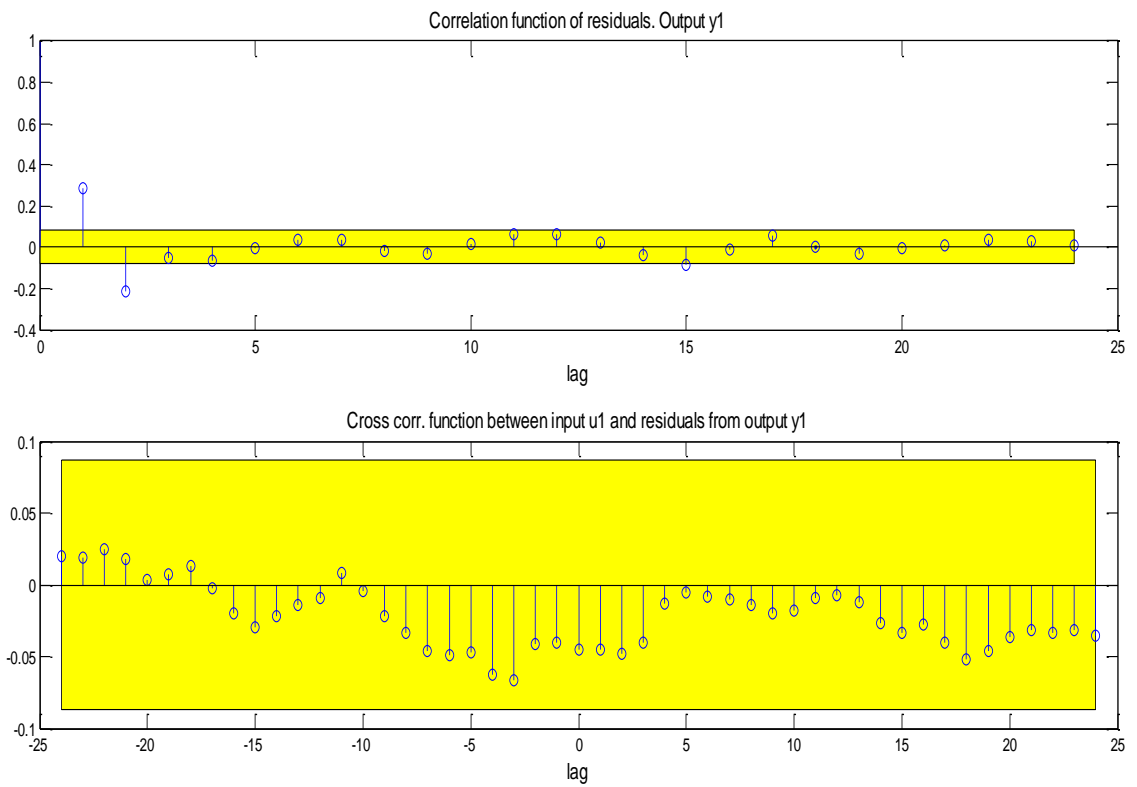

Figure 151: Residual Plot for ARX (Third Order-APRBS)

Case Study 4 (na:4; nb:4; nc:4) (APRBS)

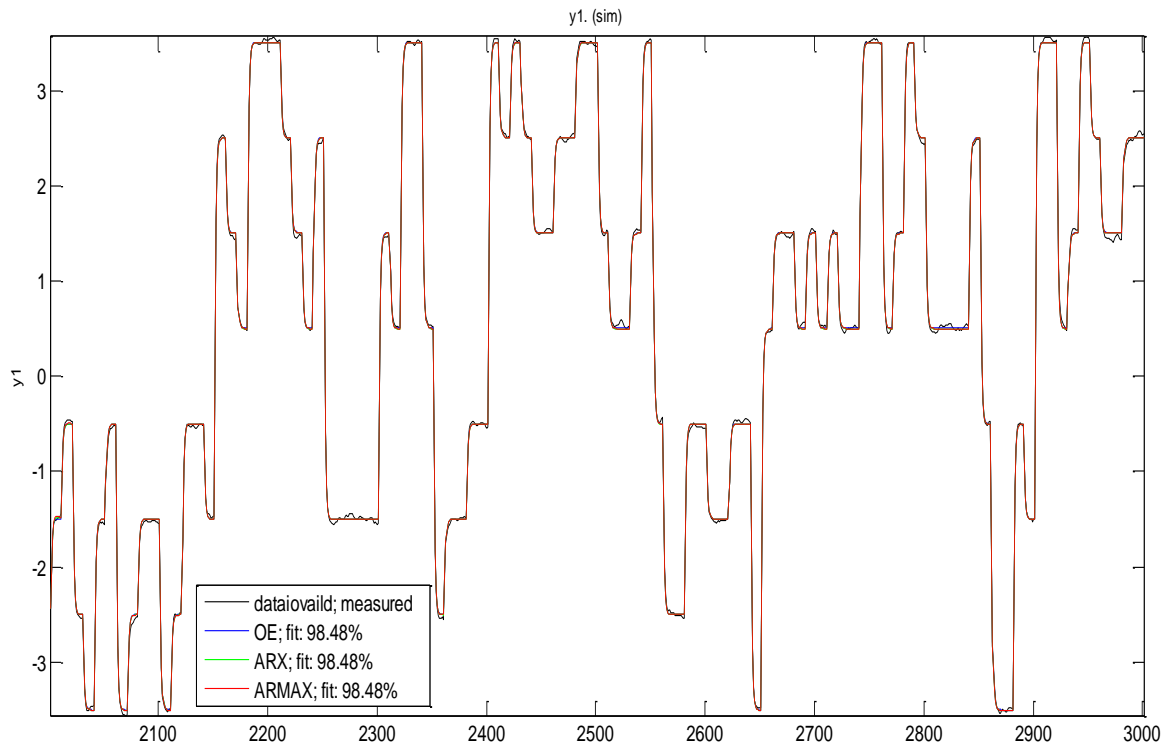

Figure 152: Comparison of model output with the actual measured values (Fourth Order-APRBS)

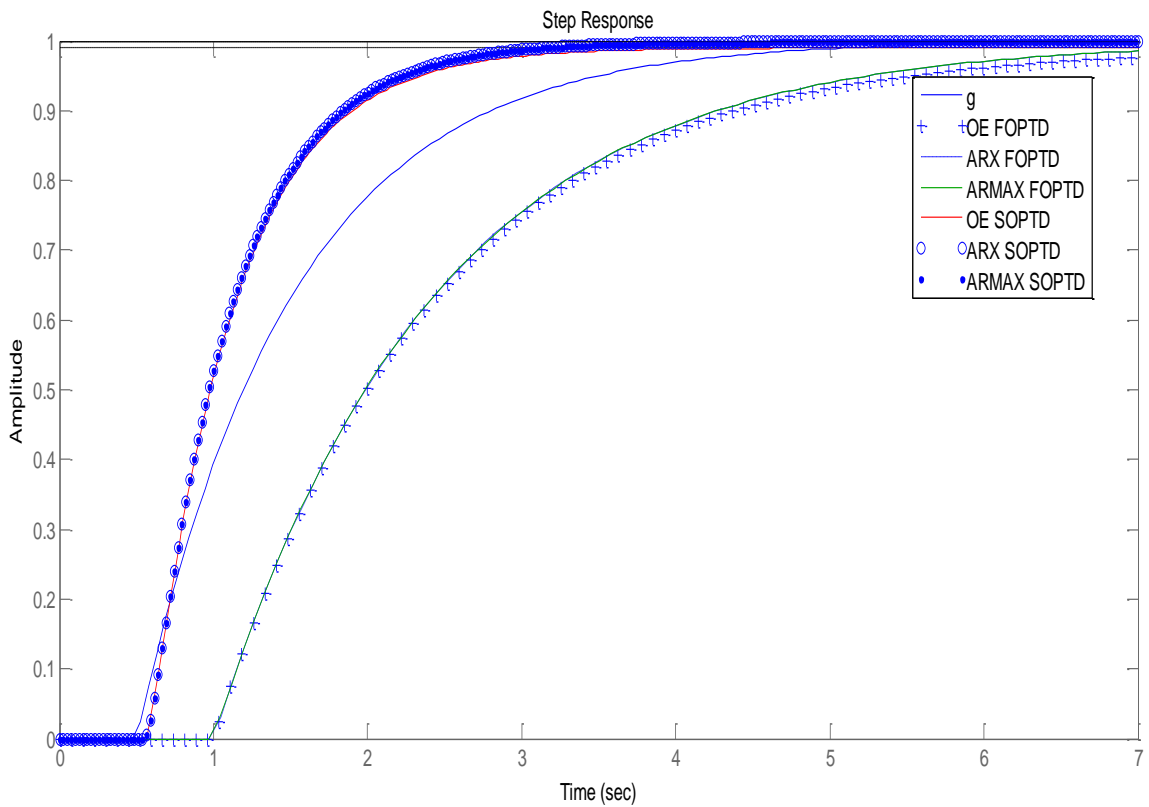

Figure 153: Step response for OE, ARX and ARMAX models (Fourth Order-APRBS)

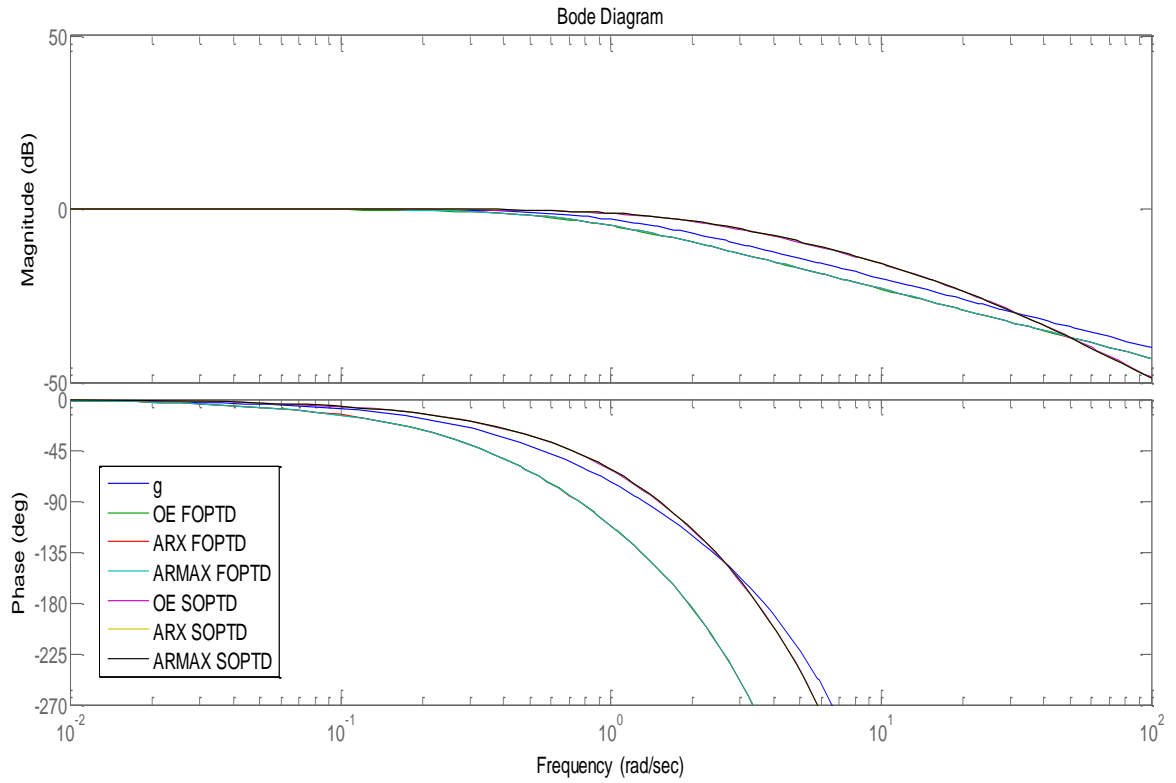

Figure 154: Bode Plot for OE, ARX and ARMAX models (Fourth Order-APRBS)

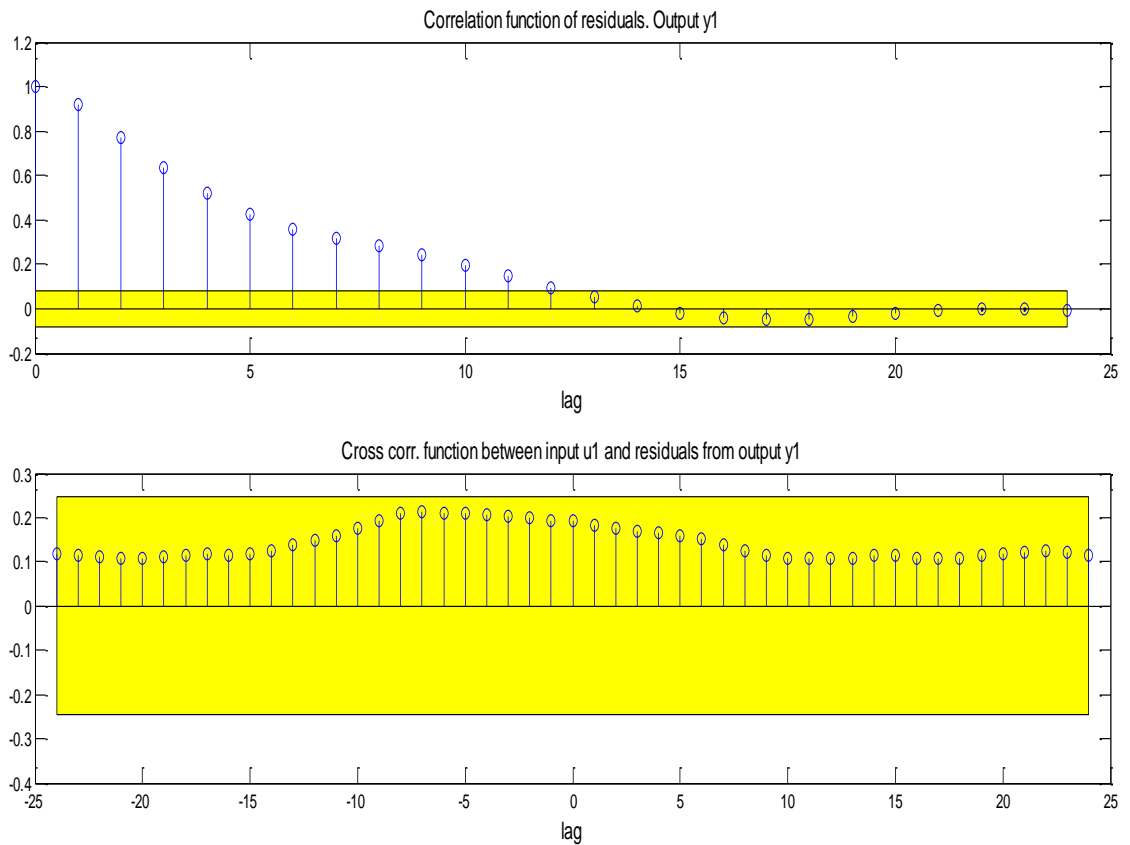

Figure 155: Residual Plot for OE (Fourth Order-APRBS)

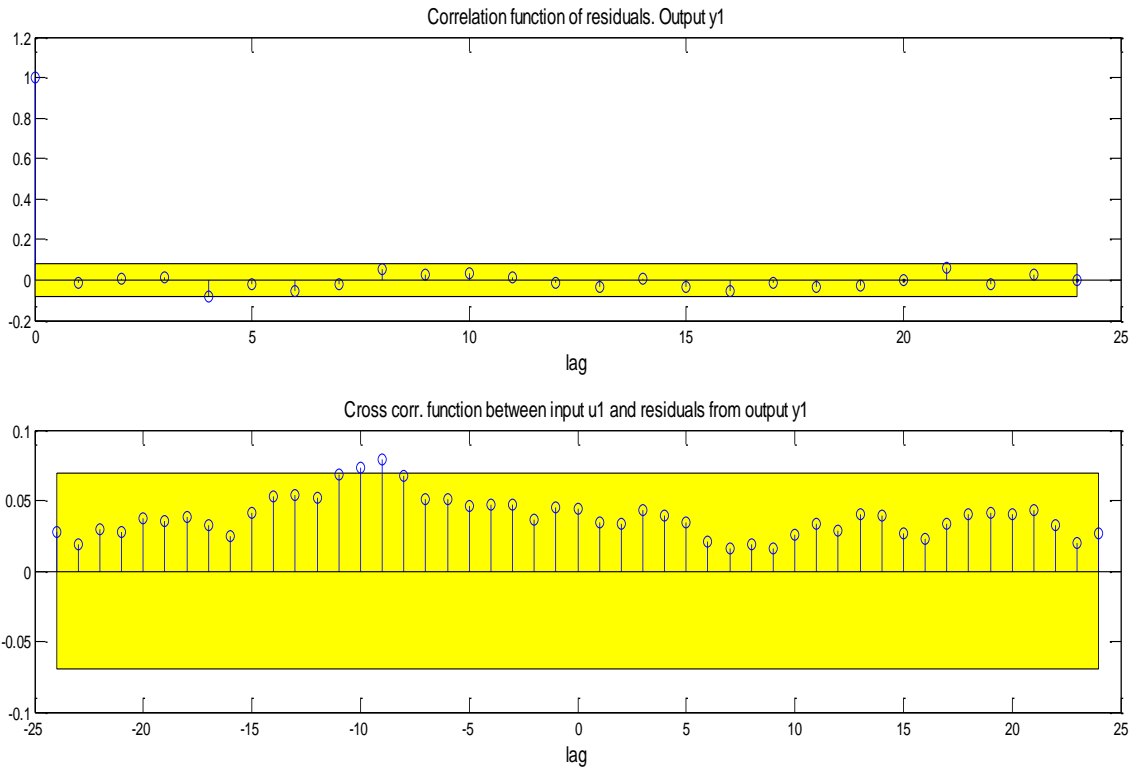

Figure 156: Residual Plot for ARMAX (Fourth Order-APRBS)

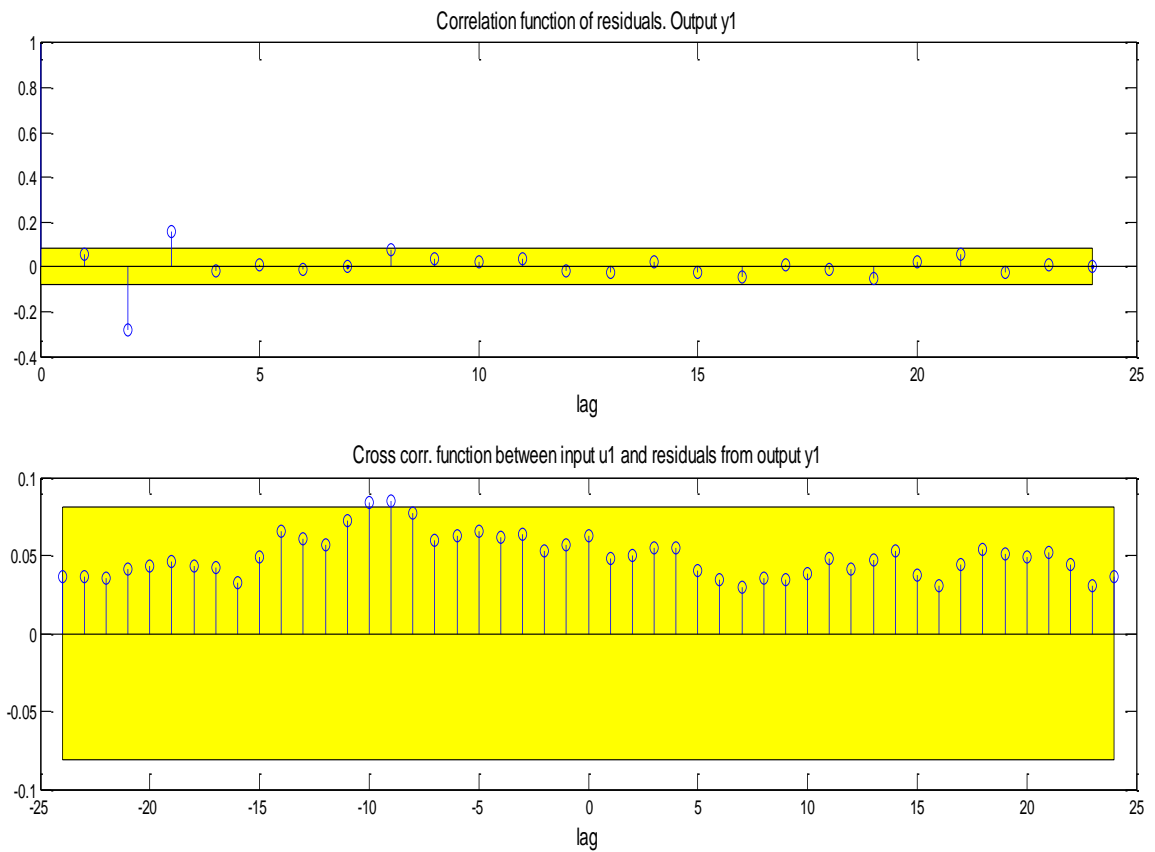

Figure 157: Residual Plot for ARX (Fourth Order-APRBS)

Case Study 5 (na:5; nb:5; nc:5) (APRBS)

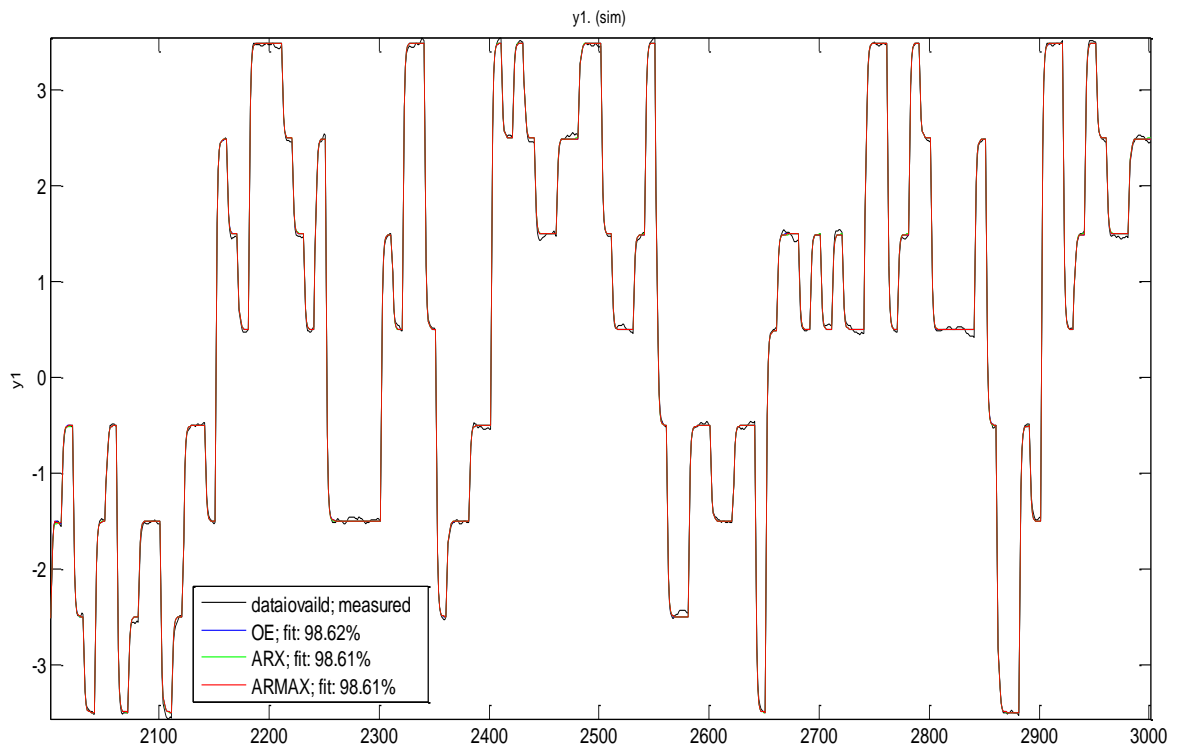

Figure 158: Comparison of model output with the actual measured values (Fifth Order-APRBS)

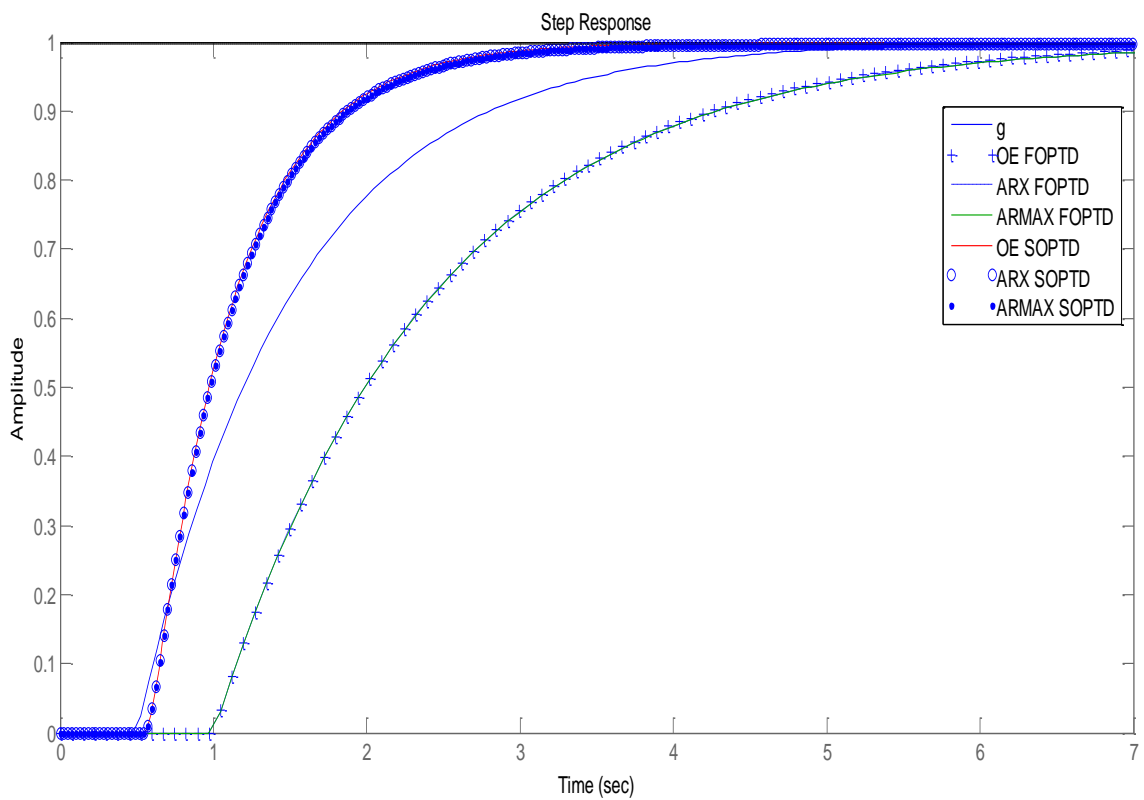

Figure 159: Step response for OE, ARX and ARMAX models (Fifth Order-APRBS)

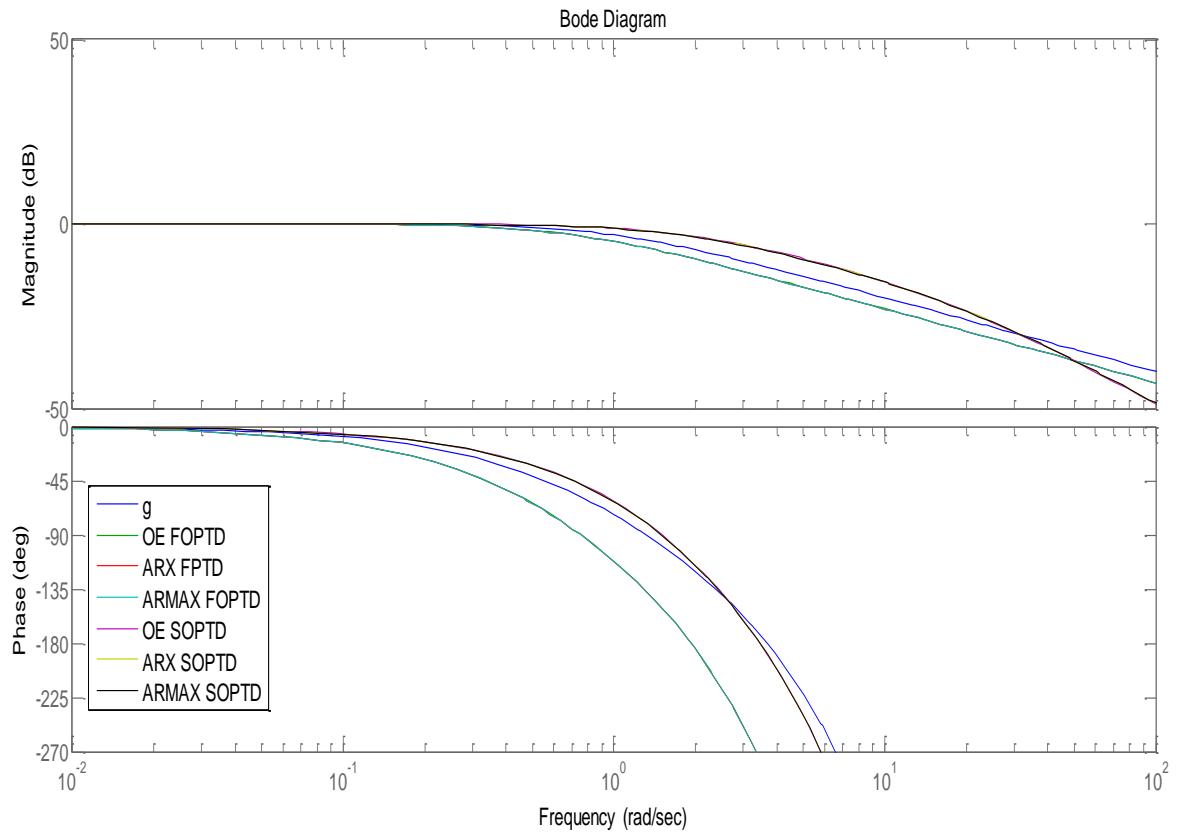

Figure 160: Bode Plot for OE, ARX and ARMAX models (Fifth Order-APRBS)

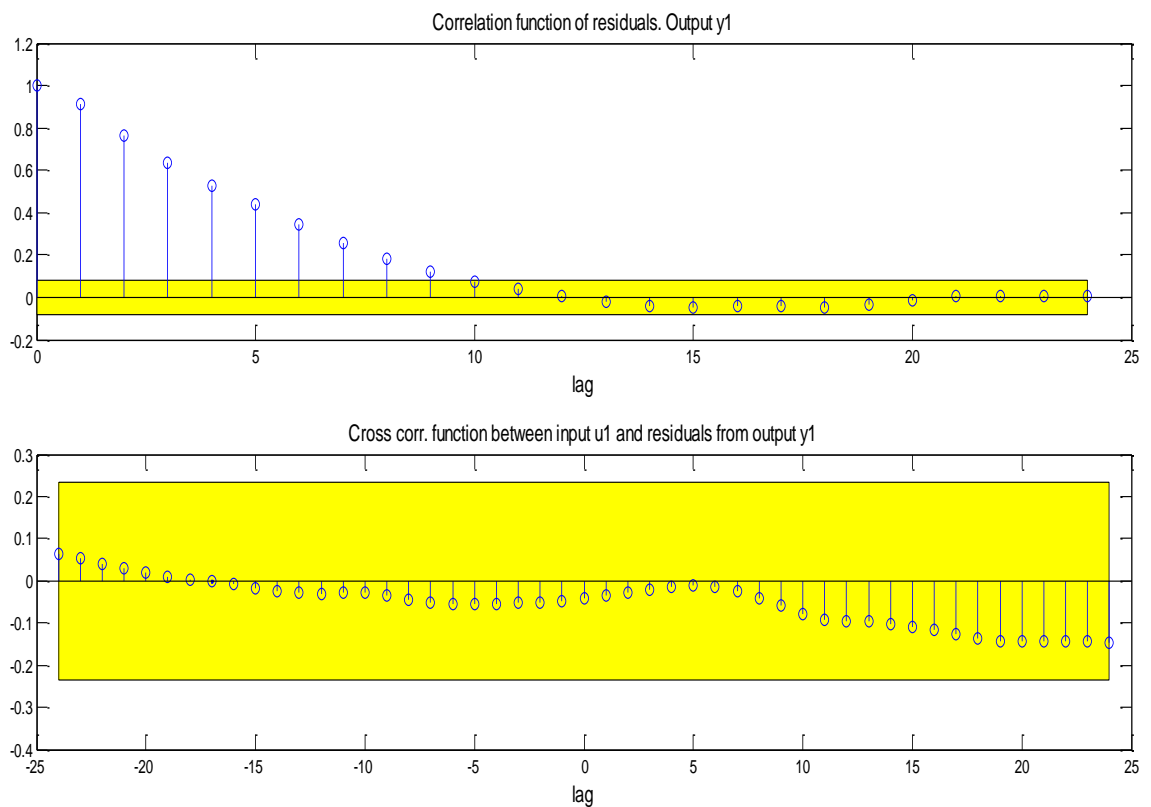

Figure 161: Residual Plot for OE (Fifth Order-APRBS)

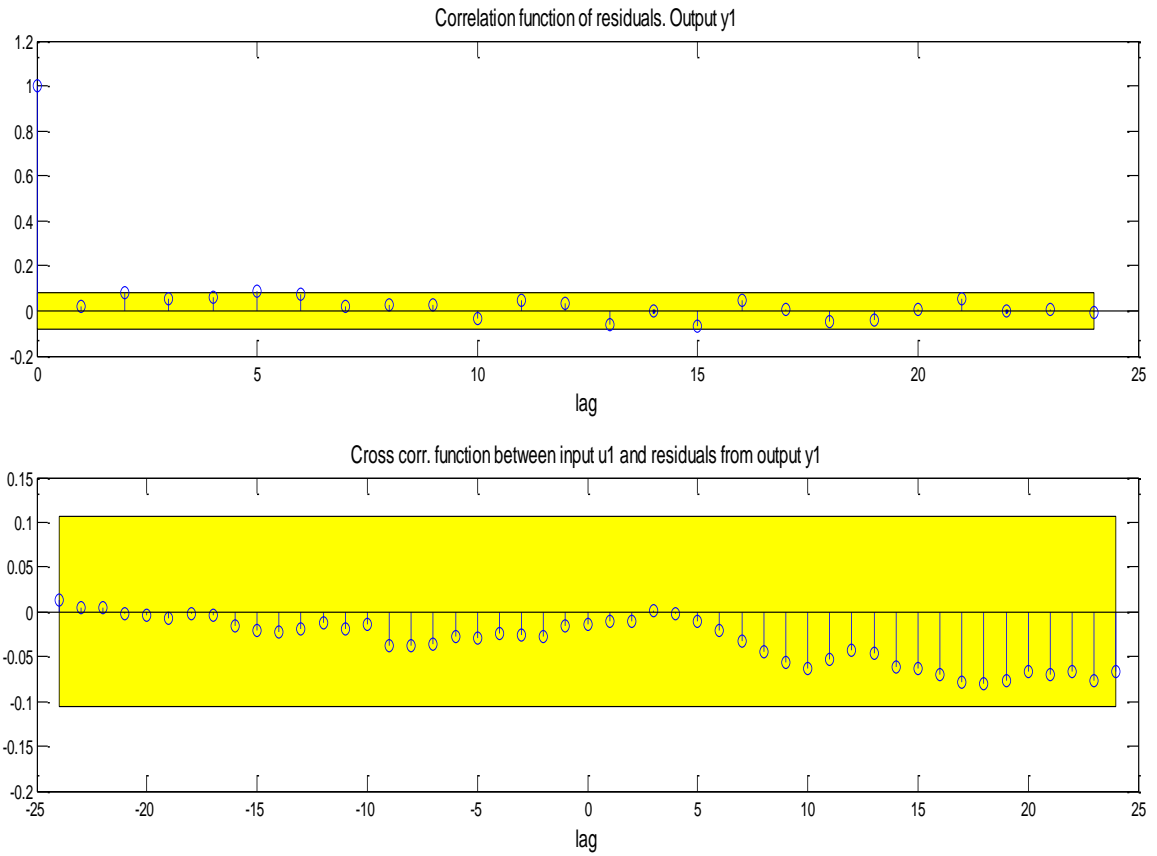

Figure 162: Residual Plot for ARMAX (Fifth Order-APRBS)

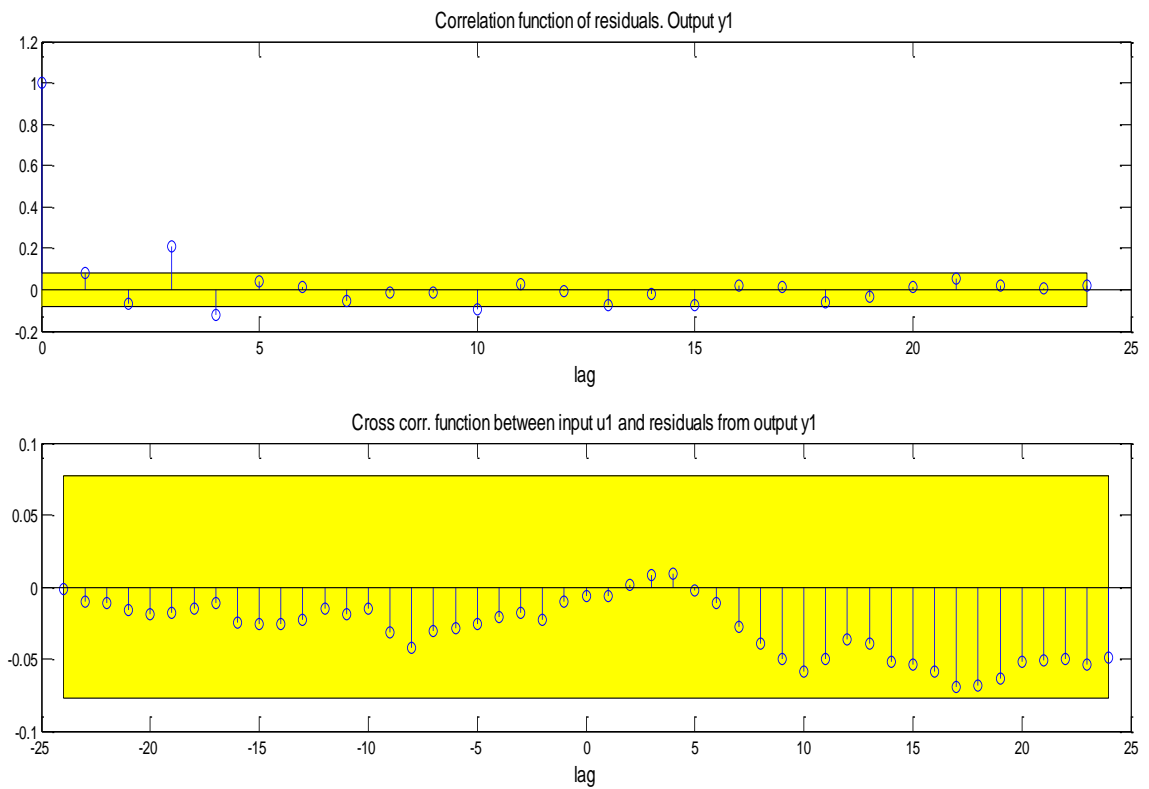

Figure 163: Residual Plot for ARX (Fifth Order-APRBS)

The system is disturbed by white Gaussian noise (WGN). All the three models approximately give different fitting for each case study. Higher fitting is resulted when the excitation signal is changed from PRBS to APRBS. This can be observed in Figure 104 and Figure 134. For PRBS signal, the fitting increases until the fourth order and it started to reduce when the order is changed to 5. This problem occurs due to the consistency problem as discussed in System 1. APRBS signal shows that the fitting increases with respect to model order. The highest fitting is shown by fourth order of ARX and ARMAX models with 97.18% (Figure 122) for PRBS signal, where else, for APRBS signal, OE model of fifth order gives 98.62% (Figure 158).

The step response graph (Figure 105) of PRBS signal with first order shows that the original system stabilizes first which is at 6 seconds, followed by SOPTD and FOPTD system. At second order, SOPTD stabilizes at 3 seconds followed by original system and FOPTD. The result is same for third, fourth and fifth orders.

The Bode diagram shows that the frequency is lower at FOPTD. The residual plot at third, fourth and fifth orders are within confidence limit. Besides that, when excitation signal changed to APRBS, it gives the same response as PRBS for step response and Bode diagram. But, the residual plot result is better than PRBS.

As a conclusion, it can be said that APRBS excitation signal gives better result compared to PRBS signal. The optimal order for this system is either first or second order as it gives good fitting with better response of other functions. Since all three models give approximately the same response, the choice of model doesn't play a major role in this case.

CHAPTER 5

CONCLUSION & RECOMMENDATION

5.1 Conclusion

The model fitting gets better as the order increases. But, it's not true for all the time. The fluctuation happens due to consistency problem. The selection of excitation signal and model structures play a major role in system identification. APRBS signal gives the best result compared to PRBS signal. Besides that, minimal hold time determines the number of stages in the signal. Thus, it will influence the characteristics of frequency. Typically, for linear system identification, the minimum hold time will be same as sampling time. The noise power is inversely proportional to the signal to noise ratio (SNR).

5.2 Recommendations

- Literature review and familiarization with system identification techniques
- Selection of systems with different dynamic characteristics and the corresponding system identification techniques
- More simulation studies by using different models, orders and noise, in order to get the best model

REFERENCES

1. Eskinat, E., Johnson, S. H., & Luyben, W. L. (1993). Use of auxiliary information in system identification. *Industrial & Engineering Chemistry Research*, 32(9), 1981-1992. doi: 10.1021/ie00021a021.
2. Garnier, H., & Mensler, M. (1999). CONTSID: a continuous-time system identification toolbox for Matlab. *Proc. of the 5th European Control Conference*.
3. Ljung, L. (1988). System identification toolbox. *The Matlab user's guide*.
4. Ljung, L. (1999). *System Identification: Theory for the User*: Prentice Hall PTR.
5. Ljung, L. (2005). *System Identification Toolbox for Use with MATLAB: User's Guide*: MathWorks, Incorporated.
6. Ljung, L., Zhang, Q., Lindskog, P., & Juditski, A. *Estimation of grey box and black box models for non-linear circuit data*.
7. Nelles, O. (2001). *Nonlinear System Identification: From Classical Approaches to Neural Networks and Fuzzy Models*: Springer.
8. Rao, G., & Unbehauen, H. (2006). *Identification of continuous-time systems*. Paper presented at the Control Theory and Applications, IEE Proceedings-.
9. de la Barra, B. A. L., Jin, L., Kim, Y. C. and Mossberg, M. (2008). Identification of First Order Time-Delay Systems using Two Different Pulse Inputs, 17th IFAC World Congress, Seoul (Korea), pp. 14366 – 14371.
10. Redele, G. (2009). A new method to estimate a first order plus time delay model from step response.
11. Junior, G. A., dos Santos, J. B. M. and Barros, P. R. (2009). On simple identification techniques for first-order plus time-delay systems 15th IFAC Symposium on System Identification, Saint-Marlo, France, p. in press.
12. Santos, J.B.M., & Barros, P.R. (2010). Simple Identification Techniques for First Order and Second Order Plus Time Delay Systems.
13. Seborg, D. E. (2011). *Process Dynamics and Control*: John Wiley & Sons, Limited.
14. Sinha, N. K., & Rao, G. P. (1991). *Identification of Continuous-Time Systems: Methodology and Computer Implementation*: Springer Netherlands.

15. Verhaegen, M., & Verdult, V. (2007). *Filtering and System Identification: A Least Squares Approach*: Cambridge University Press.
16. Ying, C.-M., & Joseph, B. (1999). Identification of Stable Linear Systems Using Polynomial Kernels. *Industrial & Engineering Chemistry Research*, 38(12), 4712-4728. doi: 10.1021/ie990310u
17. Selecting a model structure in the system identification process. (2010). Retrieved Feb, 2014, from <http://www.ni.com/white-paper/4028/en/>
18. System identification toolbox. Retrieved March, 2014, from <http://www.mathworks.com/products/sysid/description2.html>

APPENDIX

Appendix 1 (Input & Output for First System)

u	y
-1	0.0044
-1	0.0232
-1	-0.7107
-1	-0.9594
-1	-0.9830
-1	-0.9973
-1	-1.0125
-1	-1.0115
-1	-0.9777
-1	-0.9290
-1	-0.9277
-1	-0.9245
-1	-0.9047
-1	-0.9132
-1	-0.9205
-1	-0.9280
-1	-0.9412
-1	-0.9386
-1	-0.9238
-1	-0.9118
-1	-0.9076
-1	-0.9254
-1	-0.9403
-1	-0.9298
-1	-0.9227
-1	-0.9215
-1	-0.9185
-1	-0.9270
-1	-0.9377
-1	-0.9508
-1	-0.9572
-1	-0.9655
-1	-0.9887
-1	-1.0057
-1	-1.0356
-1	-1.0428
-1	-1.0221
-1	-1.0224
-1	-1.0141
-1	-1.0148
-1	-1.0275
-1	-1.0263
-1	-1.0218

-1	-1.0135
-1	-1.0160
-1	-1.0210
-1	-1.0195
-1	-1.0129
-1	-0.9969
-1	-0.9793
-1	-0.9803
-1	-0.9897
-1	-1.0005
-1	-1.0195
-1	-1.0258
-1	-1.0095
-1	-1.0019

-1	-1.0049
-1	-1.0030
-1	-0.9952
-1	-0.9957
-1	-1.0050
-1	-0.9995
-1	-0.9860
-1	-0.9664
-1	-0.9580
-1	-0.9756
-1	-0.9974
-1	-1.0126
-1	-1.0002
-1	-0.9860
-1	-0.9869

Appendix 2 (Input & Output for Second System)

u	y
-3.5000	-0.0123
-3.5000	-0.0153
-3.5000	-0.0042
-3.5000	-1.2514
-3.5000	-3.6977
-3.5000	-6.3839
-3.5000	-8.9790
-3.5000	-11.4011
-3.5000	-13.6379
-3.5000	-15.6736
-3.5000	-17.5317
-3.5000	-19.2046
-3.5000	-20.7192
-3.5000	-22.0959
-3.5000	-23.3262
-3.5000	-24.4305
-3.5000	-25.4506
-3.5000	-26.3724
-3.5000	-27.1877
-3.5000	-27.9440
-3.5000	-28.6236
-3.5000	-29.2259
-3.5000	-29.7748
-3.5000	-30.2856
-3.5000	-30.7340
-3.5000	-31.1263
-3.5000	-31.4978
-3.5000	-31.8256
-3.5000	-32.1138
-3.5000	-32.3957
-3.5000	-32.6484
-3.5000	-32.8811
-3.5000	-33.1051
-3.5000	-33.2907
-3.5000	-33.4466
-3.5000	-33.5889
-3.5000	-33.7372
-3.5000	-33.8647
-3.5000	-33.9538
-3.5000	-34.0326
-3.5000	-34.1201
-3.5000	-34.2122
-3.5000	-34.2988
-3.5000	-34.3712
-3.5000	-34.4261

-3.5000	-34.4845
-3.5000	-34.5318
-3.5000	-34.5613
-3.5000	-34.5911
-3.5000	-34.6317
-3.5000	-34.6846
-3.5000	-34.7200
-3.5000	-34.7290
-3.5000	-34.7539
-3.5000	-34.8064
-3.5000	-34.8301
-3.5000	-34.8338
-3.5000	-34.8400
-3.5000	-34.8376
-3.5000	-34.8559
-3.5000	-34.8838
-3.5000	-34.9052
-3.5000	-34.9190
-3.5000	-34.9149
-3.5000	-34.9129
-3.5000	-34.9383
-3.5000	-34.9508
-3.5000	-34.9445
-3.5000	-34.9534
-3.5000	-34.9785
-3.5000	-34.9934
-3.5000	-34.9871
-3.5000	-34.9822
-3.5000	-34.9890
-3.5000	-35.0038
-3.5000	-35.0153
-3.5000	-35.0046
-3.5000	-34.9948
-3.5000	-35.0028
-3.5000	-35.0103
-3.5000	-35.0077
-3.5000	-34.9984
-3.5000	-34.9974
-3.5000	-34.9889
-3.5000	-34.9767
-3.5000	-34.9676
-3.5000	-34.9828
-3.5000	-35.0006
-3.5000	-34.9904
-3.5000	-34.9806
-2.5000	-34.9729
-2.5000	-34.9518
-2.5000	-34.9310

-2.5000	-34.5848
-2.5000	-33.9110
-2.5000	-33.1531
-2.5000	-32.4142
-2.5000	-31.7260
-2.5000	-31.0807

Appendix 3 (Input & Output for Third System)

u	y
-3.5000	0.0044
-3.5000	-1.3540
-3.5000	-2.7027
-3.5000	-3.2102
-3.5000	-3.3825
-3.5000	-3.4591
-3.5000	-3.4983
-3.5000	-3.5062
-3.5000	-3.4758
-3.5000	-3.4283
-3.5000	-3.4275
-3.5000	-3.4244
-3.5000	-3.4047
-3.5000	-3.4132
-3.5000	-3.4205
-3.5000	-3.4280
-3.5000	-3.4412
-3.5000	-3.4386
-3.5000	-3.4238
-3.5000	-3.4118
-3.5000	-3.4076
-3.5000	-3.4254
-3.5000	-3.4403
-3.5000	-3.4298
-3.5000	-3.4227
-3.5000	-3.4215
-3.5000	-3.4185
-3.5000	-3.4270
-3.5000	-3.4377
-3.5000	-3.4508
-3.5000	-3.4572
-3.5000	-3.4655
-3.5000	-3.4887
-3.5000	-3.5057
-3.5000	-3.5356
-3.5000	-3.5428
-3.5000	-3.5221
-3.5000	-3.5224
-3.5000	-3.5141
-3.5000	-3.5148
-3.5000	-3.5275
-3.5000	-3.5263
-3.5000	-3.5218
-3.5000	-3.5135
-3.5000	-3.5160
-3.5000	-3.5210

-3.5000	-3.5195
-3.5000	-3.5129
-3.5000	-3.4969
-3.5000	-3.4793
-3.5000	-3.4803
-3.5000	-3.4897
-3.5000	-3.5005
-3.5000	-3.5195
-3.5000	-3.5258
-3.5000	-3.5095
-3.5000	-3.5019
-3.5000	-3.5049
-3.5000	-3.5030
-3.5000	-3.4952
-3.5000	-3.4957
-3.5000	-3.5050
-3.5000	-3.4995
-3.5000	-3.4860
-3.5000	-3.4664
-3.5000	-3.4580
-3.5000	-3.4756
-3.5000	-3.4974
-3.5000	-3.5126
-3.5000	-3.5002
-3.5000	-3.4860
-3.5000	-3.4869
-3.5000	-3.4843
-3.5000	-3.4809
-3.5000	-3.4827
-3.5000	-3.5029
-3.5000	-3.5256
-3.5000	-3.5295
-3.5000	-3.5227
-3.5000	-3.5224
-3.5000	-3.5091
-3.5000	-3.4938
-3.5000	-3.4907
-3.5000	-3.4774
-3.5000	-3.4743
-3.5000	-3.4790
-3.5000	-3.4695
-3.5000	-3.4691
-3.5000	-3.4738
-3.5000	-3.4854
-2.5000	-3.5065
-2.5000	-3.1206
-2.5000	-2.7284
-2.5000	-2.5595

-2.5000	-2.4952
-2.5000	-2.4851
-2.5000	-2.4811
-2.5000	-2.4983
-2.5000	-2.5173
-2.5000	-2.5328