

**Analytical Solution For The First Order Reversible Reaction System Through Flow
Graph Theory Approach**

by

Nurul Amira Syakilla Binti Hasan

Dissertation submitted in partial fulfillment
of the requirement for the
Bachelor of Engineering (Hons)
(Chemical Engineering)

SEPTEMBER 2012

Universiti Teknologi PETRONAS,
Bandar Seri Iskandar,
31750 Tronoh,
Perak Darul Ridzuan.

CERTIFICATION OF APPROVAL

Analytical Solution For The First Order Reversible Reaction System Through Flow Graph Theory Approach

by

Nurul Amira Syakilla Bt Hasan

A project dissertation submitted to the
Chemical Engineering Programme
Universiti Teknologi PETRONAS
in partial fulfilment of the requirement for the
BACHELOR OF ENGINEERING (Hons)
(CHEMICAL ENGINEERING)

Approved by,

(Dr. Periyasamy Balasubramanian)

UNIVERSITI TEKNOLOGI PETRONAS
TRONOH, PERAK
September 2012

CERTIFICATION OF ORIGINALITY

This is to certify that I am responsible for the work submitted in this project, that the original work is my own except as specified in the references and acknowledgements, and that the original work contained herein have not undertaken or done by unspecified sources or person.

(NURUL AMIRA SYAKILLA BT HASAN)

ABSTRACT

An analytical solution for the first order reversible reaction was derived using the flow theory approach. Reversible reactions are the chemical reactions that results in an equilibrium mixture of reactants and products. The usage of flow graph theory was simpler and more direct in solving the exact solution which then will eliminate the classical integration, Laplace transform and eigenvalue methods. The flow graph was based the image of reaction stoichiometry and the ratio of consumption and formation flow graph was used to find an analytical solution of the reaction system. In this report, the analytical solutions for the two species and three species reaction system were derived and verified with the numerical integration of the governing ordinary differential equations by using MATLAB software.

ACKNOWLEDGEMENT

In the name of Allah, the Most Gracious and the Most Merciful

Alhamdulillah, all praises and thanks in Almighty Allah S.W.T for His Blessing in giving the author strengths and sufficient time in completing this project. Special appreciation goes to my supervisor, Dr. Periyasamy Balasubramanian from the Chemical Engineering Department Universiti Teknologi PETRONAS for his endless supervisions and advice for the whole two semesters. Special thanks to the Coordinator Chemical Department, Dr. Nurhayati Mellon for guiding and smoothing all the requirements that the author needs to fulfill throughout the Final Year Project. Not forgotten, the author would like to thank all her colleagues, technician and housemate who have contributed directly and indirectly throughout the final year project for their kindness. Last but not least, deepest gratitude to the author's family, Hasan Bin Muda and Salmah Bt Rani for their support, understanding and encouragement throughout this project. Thank you very much.

TABLE OF CONTENTS

CERTIFICATION OF APPROVAL	ii
CERTIFICATION OF ORIGINALITY	iii
ABSTRACT	iv
ACKNOWLEDGEMENT	v
LIST OF FIGURES	viii
LIST OF TABLES	viii
NOMENCLATURE	ix

CHAPTER 1:	INTRODUCTION		
	1.1	Background Study	1
	1.2	Flow Graph Theory	2
	1.3	Problem Statement	3
	1.4	Objective and Scope of Work	4
	1.5	Relevancy and Feasibility of Work	4
CHAPTER 2:	LITERATURE REVIEW		
	2.1	Literature Review and Theory	5
	2.2	Model Equations for Reversible Reaction System	7
CHAPTER 3:	METHODOLOGY		
	3.1	Methodology	9
	3.2	Gantt Chart	10
	3.3	Key Milestone	11
	3.4	Hardware/Tool	11
CHAPTER 4:	RESULT		
	4.1	Analytical Solution For The Two Species Reacting System	12

	4.1.1 Consumption Flow Graph	13
	4.1.2 Formation Flow Graph	15
	4.2 Analytical Solution For The Three Species Reacting System	18
	4.1.1 Consumption Flow Graph	19
	4.1.2 Formation Flow Graph	20
CHAPTER 5:	CONCLUSION	25
REFERENCES		26
APPENDICES		28

LIST OF FIGURES

Figure 1: Example of Flow Graph of Two Species in Reversible Reaction	2
Figure 2: The Methodology of Analytical Solution for the Reaction System Through Flow Graph Theory Approach	9
Figure 3: Example of MATLAB	11
Figure 4: The Consumption Flow Graph for Two Species Reacting System	13
Figure 5: The Formation Flow Graph for Two Species Reacting System (Reactant S_1)	15
Figure 6: The Formation Flow Graph for Two Species Reacting System (Product S_2)	16
Figure 7: Concentration-Time Curves for Two Species Reacting System	17
Figure 8: Kinetic Model For Three Species Reacting System	18
Figure 9: The Consumption Flow Graph For Three Species Reacting System	19
Figure 10: The Formation Flow Graph for Three Species Reacting System (Reactant S_1)	20
Figure 11: The Formation Flow Graph for Three Species Reacting System (Product S_2)	21
Figure 12: The Formation Flow Graph for Three Species Reacting System (Product S_3)	22
Figure 13: Concentration-Time Curves for Three Species Reacting System	24

LIST OF TABLES

Table 1: Gantt Chart Throughout FYP I & FYP II	10
Table 2: Project Milestone	11
Table 3: Hardware/Tools	12

NOMENCLATURES

c_s = vector of molar concentration of the species s_i (i varies from 1 to N_s)

F_1 = label for the initial feed fraction of the species 1 in the formation flow graph

K = matrix form of the kinetic constants (h^{-1})

$k_{j,i}$ = kinetic constant for the formation of product j from the reactant i by virtue of chemical reaction (h^{-1})

N_s = number of species for a chemical reaction

P_1 = label for the formation of final product from the reactant S_1 in the formation and consumption flow graph

R_k = matrix form of coefficients of the kinetic equations

r_{s_1} = rate of reaction for the species 1

t = reaction time (h)

S_1 = symbol for reacting species 1

\varkappa = sum of kinetic constants (h^{-1})

ΔC = determinant of consumption flow graph

Δf_{s_1} = determinant of formation flow graph for species 1

CHAPTER 1

INTRODUCTION

1.1 Background

In the chemical process industry, desired product is produced from a variety of starting materials through a succession of either physical or chemical treatment steps profitably. The raw materials undergo a number of physical treatments to put them in the form which they can be reacted chemically with a certain rate of reaction (Levelspiel, 1999).

A reversible reaction is a common reaction that has been used in industry in order to optimize the production of desired product (Bursten, 2003). This reaction proceeds in both directions forward and backward simultaneously. The reverse and forward reactions will occur at the same rate and then, it achieves equilibrium. In this project, the main objective of the work is the derivation of analytical solution for a reversible reaction with two and three species.

There are two methods that can be used to solve the first order of reversible reaction which are the analytical method and numerical method. The main advantage of the numerical method is the differential equations are easy to write and has been applied in the specialized software, however, numerical method always gives the solutions with an approximation and this may cause some errors. Other than that, the process also reach convergence slower compared to the analytical solution. According to Bhusare et al (2010), analytical solution offers explicit mathematical description of without using numerical method and it can be calculated by using classical integration, Laplace transform, eigenvalue methods, flow graph theory and so on. The analytical solution provides the solution with the higher accuracy. Then, it is important to obtain the suitable analytical solution in calculating the kinetics constant and characteristics of the

reaction. In this project, the flow graph theory has been applied to derive the exact solution for the first order reversible system which then eliminates the usage of other methods. A flow graph is graphical diagram which represents the reaction stoichiometry. It consists a network which nodes (system variable) are connected by an edge either outgoing or ingoing which acts as a signal multiplier.

1.2 Flow Graph Theory

Flow graph theory is one of the methods that used in finding the analytical solution for a process of linear differential equations. It is a graphical diagram that models logic patterns by using connective functions and transitions. The model will be explained the relations and reaction mechanism of the systems. In finding the analytical solution of the reaction, the flow graph represents the reaction stoichiometry. Then, it will be drawn based on a set of simultaneous linear algebraic equations or a linear algebraic or a linear differential equations system, which are written starting from a chemical reactions included into a mechanism which normally consists of the reactants and products.

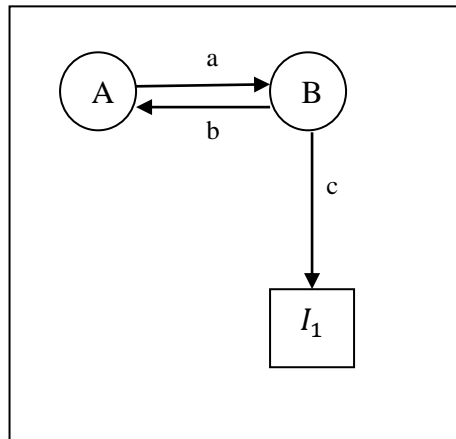

Figure 1: Example of Flow Graph of Two Species in Reversible Reaction

From Figure 1, the 'a', 'b' and 'c' are the edges. The edge is connected two nodes and the gain of the edge is the transmittance. The transmittance can be expressed in terms of transfer function between two nodes. "A" and "B" are the internal nodes. The internal node has both ongoing and outgoing edges. For the reversible reaction, the reactant and product usually have the internal nodes instead of the input node or output node. It is

because in the reversible reaction, the reactant and product are constantly reacting and being produced. Input node (known as source) has only outgoing edge which is usually represented the reactant species. Meanwhile, the output node has only the ongoing edges as I_1 .

The main function of the flow graph is to determine the ratio of formation and consumption flow graph through the derivation of main determinant of the system. The flow graph is used to represent the evolution of a physical system and to obtain the relationships between the system variables. The flow graph theory will help in obtaining the kinetics characteristics of chemical reaction scheme and the concentration of the species or reactant in the reactions. It is also does not required to write the homogenous or non-homogenous linear differential equations which is more complex.

1.3 Problem Statement

Solving the analytical solution for the kinetic equations of chemically reacting system is important in optimizing the formation of products from reactants. Other than that, it also can describe the kinetics of chemical reactions and the oscillations in reacting system. However, it is complicated to solve the analytical solution by writing the homogenous or non-homogenous linear differential equations especially for the reaction systems with more number of species (Socol et al, 2009). Researchers have derived the analytical solution for the two and three species reaction systems by using Laplace transform, numerical integration and eigenvalue methods. Flow graph theory is simple method that utilizes the determinant concept to derive an analytical solution for the reacting species. This method eliminates the usage of other chemical methods such as Laplace transform, eigenvalue problem and so on. Thus, it has been proposed to demonstrate the applicability of the flow graph theory for deriving analytical solution of the reversible reaction systems.

1.4 Objectives and Scope of Work

The objectives of this work are:

1. To derive an analytical solution for the kinetic equations of the two species reacting system using flow graph theory approach.
2. To derive an analytical solution for the kinetic equations of the three species reacting system using flow graph theory approach.

In this research, the flow graph theory approach will be applied in finding the consumption and formation flow graph which then leads to the derivation of analytical solution for the kinetics equation.

1.5 Relevancy and Feasibility of Work

Based on the studied that has been done by Bhusare et al, 2010, analytical solution is more accurate compared to the numerical solution due as the numerical solution usually will give an approximation which may lead to error. Then, kinetic modeling of analytical solution for the first order reversible reaction system through flow graph theory approach is important in chemical process industry nowadays as it can control and optimize the selectivity and activity of feedstock which produce the desired product profitably. Other than that, the information on the kinetic rate and constants is also important in order to improve the yield and selectivity.

CHAPTER 2

LITERATURE REVIEW

2.1 Literature Review and Theory

In the literature, researchers had developed explicit mathematical expressions for the first order reversible reactions using various techniques such as Laplace transforms, eigenvalue methods, and so forth. In 1971, a general method for the analytical solution of the first order reversible reactions was proposed using eigenvalue method (Chu, 1971). Later, the analytical solution for the two and three species reversible reacting system was derived using eigenvalue method (Pogliani et al, 1996), approximation method (Chrastil et al, 1993), and Laplace transforms (Korobov, 2011).

According Socol and Baldea (2006), in solving the homogeneous and non-homogeneous differential equation systems, the application flow graph theory is much simpler and direct compared to the employment of Laplace transform. Laplace transform is classical method for determining the solution for the kinetic equations. Laplace transforms deals with the convolution integral for non-homogeneous systems. In many cases, it is very simple operation and also the classical method requires integrals when the input function is complicated one (Bhusare et al, 2010). The flow graph is simpler as the analytical solution can be solved by defining the consumption and formation determinant between the system variables. It is defined by Socol et al (2009) that the consumption determinant is the main determinant of the system while the formation determinant is the determinant from the flow graphs indicate a gain of the chosen variable starting from an input mode.

Other than that, the determinants can be defined starting with the reaction mechanism. The flow graph theory can be obtained rightly from a reaction mechanism. Besides that, from the journal entitled ‘A New Paradigm in Kinetic Modeling of Complex Reaction

Systems', it stated that the flow graph theory in chemical kinetics eliminates the usage of Laplace transform in order to find the solution for the system which arise as a result of species mole balance in a constant density batch reactor/ideal plug flow reactor (Bhusare et al, 2010).

Besides that, in the complex pharmacokinetic (PK) model, the analytical solution through the flow graph theory can directly obtained by inspection of the graphical representation of the model. Pharmacokinetic analysis is the analysis that involves the complex drug absorption and disposition. The analytical solution also can be obtained for the linear differential equation systems by using the secular equation and eigenvalues method, constant variation method and classical integration. However, it is more complicated compared to the flow graph theory (Bursten, 2003).

There are mainly two types of chemical reactions which are reversible and irreversible reactions. The reversible reaction is important as the reactants will be used up until zero reactants in the process. The examples of reversible reactions are

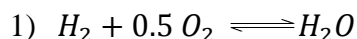

- The hydrogen and oxygen burn to become water and can be converted back by electrolysis.

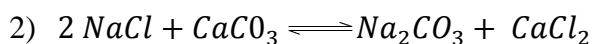

- Formation of sodium carbonate can be reversed.

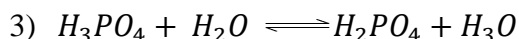

- The conversion of the phosphoric solution into dihydrogen phosphate.

Reversible reaction will optimize the production and reduce the cost for the systems. The information on the kinetics constants will helps in controlling the activity of the feedstock and the selectivity of the products in order to reduce the formation of the byproducts (Bursten, 2003).

2.2 Model Equations for Reversible Reaction System

A general stoichiometry of the first order reversible reaction system (Connors, 1990) can be represented as

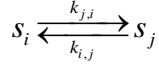

Where, $k_{j,i}$ is the kinetic constant for the formation of product j from the reactant i by virtue of chemical.

$$K = \begin{bmatrix} 0 & k_{1,2} & k_{1,3} & k_{1,4} & \cdots & k_{1,N_s-1} & k_{1,N_s} \\ k_{2,1} & 0 & k_{2,3} & k_{2,4} & \cdots & k_{2,N_s-1} & k_{2,N_s} \\ k_{3,1} & k_{3,2} & 0 & k_{3,4} & \cdots & k_{3,N_s-1} & k_{3,N_s} \\ k_{4,1} & k_{4,2} & k_{4,3} & 0 & \cdots & k_{4,N_s-1} & k_{4,N_s} \\ \vdots & \vdots & \vdots & \vdots & \vdots & \vdots & \vdots \\ k_{N_s-1,1} & k_{N_s-1,2} & k_{N_s-1,3} & k_{N_s-1,4} & \cdots & 0 & k_{N_s-1,N_s} \\ k_{N_s,1} & k_{N_s,2} & k_{N_s,3} & k_{N_s,4} & \cdots & k_{N_s,N_s-1} & 0 \end{bmatrix}$$

In a matrix K , the subdiagonal and superdiagonal elements represent the kinetic constants for the forward and reverse reactions, respectively. Each column represents the kinetic constants for all possible parallel reactions from the reactant. It is assumed that the reaction occurring in a batch reactor is similar as in an ideal plug flow reactor as the unsteady state mole balance in a batch reactor is similar to that of steady state mole balance in an ideal plug flow reactor when the volume change due to chemical reaction is neglected. The vector form of kinetic equations for the first order reversible reactions can be represented as

$$\dot{c}_s = R_k c_s$$

Where, c_s is a vector of molar concentration of the species s_i (i varies from 1 to N_s), and R_k is a matrix form of coefficients of the kinetic equations and is given by

$$R_k = \begin{bmatrix} -\sum_{j=2}^{N_s} k_{j,1} & k_{1,2} & k_{1,3} & k_{1,4} & \cdots & k_{1,N_s-1} & k_{1,N_s} \\ k_{2,1} & -\sum_{\substack{j=1 \\ j \neq 2}}^{N_s} k_{j,2} & k_{2,3} & k_{2,4} & \cdots & k_{2,N_s-1} & k_{2,N_s} \\ k_{3,1} & k_{3,2} & -\sum_{\substack{j=1 \\ j \neq 3}}^{N_s} k_{j,3} & k_{3,4} & \cdots & k_{3,N_s-1} & k_{3,N_s} \\ k_{4,1} & k_{4,2} & k_{4,3} & -\sum_{\substack{j=1 \\ j \neq 4}}^{N_s} k_{j,4} & \cdots & k_{4,N_s-1} & k_{4,N_s} \\ \vdots & \vdots & \vdots & \vdots & \vdots & \vdots & \vdots \\ k_{N_s-1,1} & k_{N_s-1,2} & k_{N_s-1,3} & k_{N_s-1,4} & \cdots & -\sum_{\substack{j=1 \\ j \neq N_s-1}}^{N_s} k_{j,N_s-1} & k_{N_s-1,N_s} \\ k_{N_s,1} & k_{N_s,2} & k_{N_s,3} & k_{N_s,4} & \cdots & k_{N_s,N_s-1} & -\sum_{j=1}^{N_s-1} k_{j,N_s} \end{bmatrix}$$

The properties of matrix R_k are:

- (i) Sum of each column of the matrix is zero.
- (ii) Sum of all the kinetic constants for the disappearance of reactant i is represented by the diagonal elements, and
- (iii) Subdiagonal and superdiagonal elements represent the kinetic constants for the forward and reverse reactions, respectively.

Then, a general exact solution is derived by using flow graph theory approach and therefore, it is decided to use this approach for the simple chemical reaction schemes such as two and three species reacting systems.

CHAPTER 3

METHODOLOGY

3.1 Methodology

The methodology involved in this project work as given below.

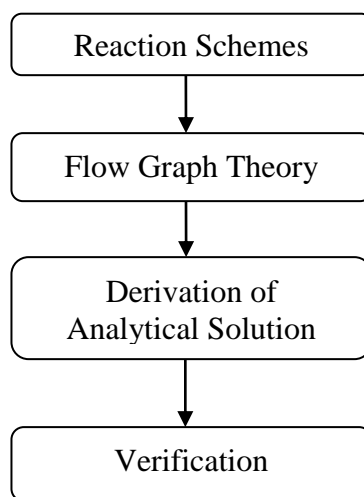
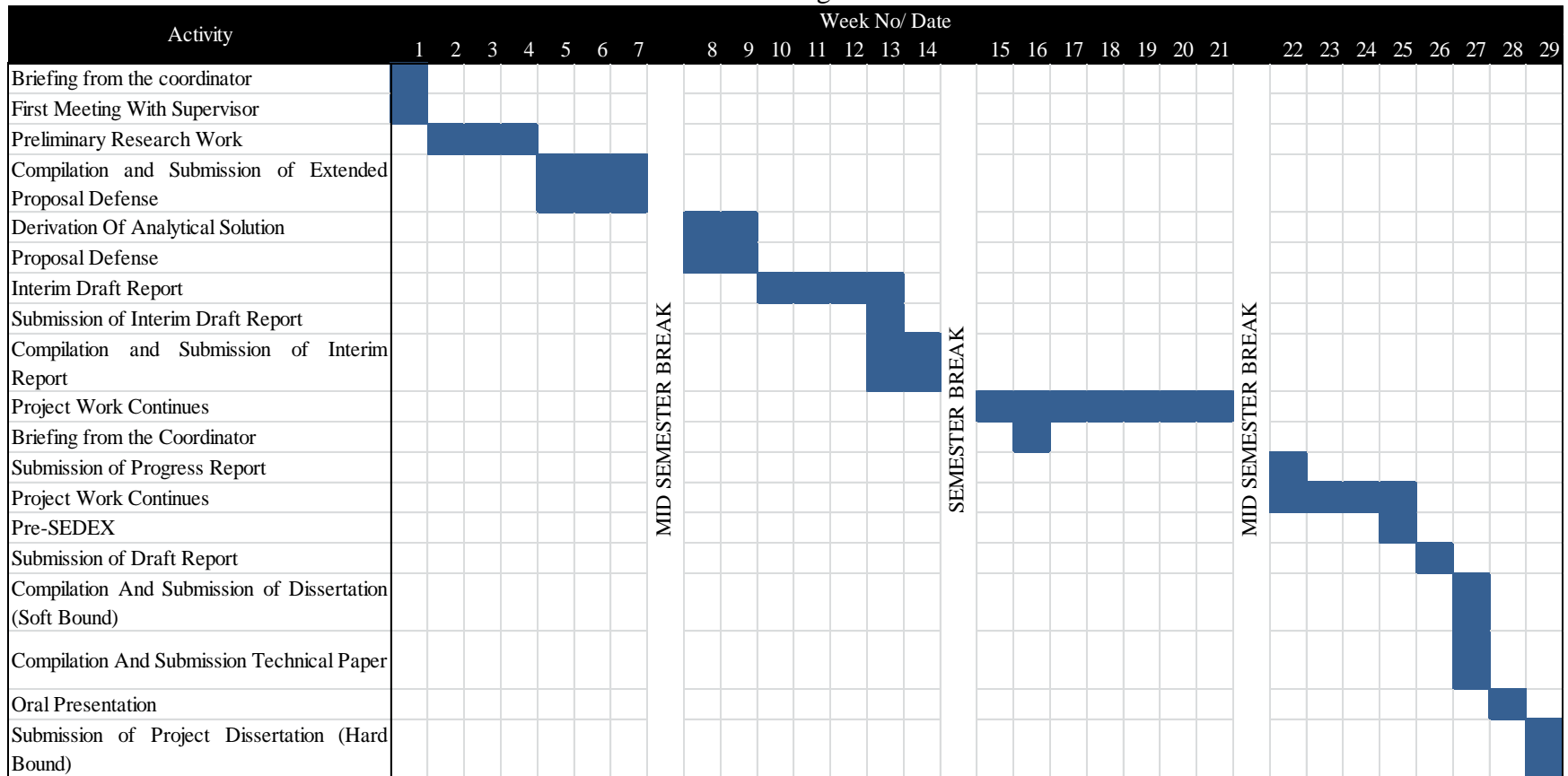

Figure 2: The Methodology of Analytical Solution for the Reaction System through Flow Graph Theory Approach.

This methodology can be refer from the journal entitled 'New Method of Finding the Analytical Solutions Directly on the Base on The Reaction Mechanism (Socol et al, 2009)', 'A New Paradigm in Kinetic Modeling of Complex Reaction Systems (Bhusare et al 2010)' and 'A New Approach of Flow Graph Theory Applied in Physical Chemistry (Socol et al, 2006)'.

3.2 Gantt Chart

Table 1: Gantt Chart Throughout FYP I & FYP II



3.3 Project Milestone

The milestone of this work is shown in the table below:

No.	Activities	Timeline
1	Derivation of analytical solution for two species reacting system using the flow graph theory.	FYP I
2	Derivation of analytical solution for three species reacting system using the flow graph theory.	FYP II

Table 2: Project Milestone

3.4 Hardware/ Tools

No	Name	Description
1.	MATLAB	-To verify the analytical solution of the reaction.

Table 3: Hardware/Tools

Matrix Laboratory (MATLAB) is one of the programming languages which apply the application of algorithm, the matrix manipulations. It is able to perform the analytical solutions for the mathematics, science and engineering problems. Other than that, MATLAB is widely used as it is able to process image and signal, control design, communications, financial modeling and analysis, communications and computational biology. It is because MATLAB is faster in solving the technical computing problems compared to the other programming language such as C++, C and Fortran.

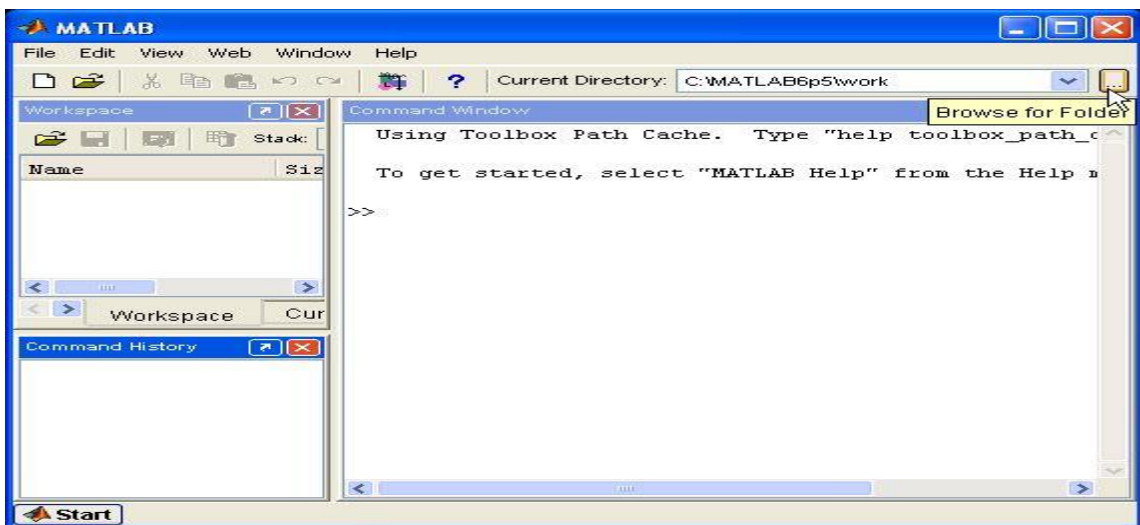

Figure 3: Example of MATLAB

CHAPTER 4

RESULTS AND DISCUSSION

4.1 Analytical Solution For The Two Species Reacting System

The stoichiometry of the two species reacting system which taken place in a batch reactor is given by

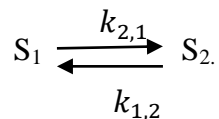

Kinetic models represent the molecular interactions in the mixture that occur within the reaction. It involves the broken of chemical bonds and reformation of the new compound. It offers the best accuracy and reliability. Firstly, to describe the reversible reaction, a kinetic model will be constructed in order to characterize the reaction mechanisms using the system linear differential equation. The mechanism composes of a few of reaction pathways and the rate coefficients for each reaction pathway. Besides that, the mechanism also consists of the information on the reverse rate coefficients and its thermodynamic properties.

It is assumed that the reaction occurs in the constant-volume batch reactor. The rate of reaction for the reactant, S_1 and product, S_2 are (Frost, 1961)

$$r_{S_1} = -k_{2,1}S_1 + k_{1,2}S_2$$

$$r_{S_2} = k_{2,1}S_1 - k_{1,2}S_2 .$$

The mole balance equation for the reactant S_1 and product, S_2 are

$$\frac{dC_{S_1}}{dt} = -k_{2,1}S_1 + k_{1,2}S_2$$

$$\frac{dC_{S_2}}{dt} = k_{2,1}S_1 - k_{1,2}S_2.$$

The analytical solution for the above-mentioned kinetic equations can be written as

$$S_i = \sum_{j=1}^{N_S} A_{ij} \exp(\tau_j t).$$

Where, $i=1,2,\dots,N_S$ and N_S is the number of species for a chemical reaction.

4.1.1 Consumption Flow Graph

The determinant of the systems can be determined using matrixes, consumption flow graph and formation flow graph. Determinant suggests on the evolution of the species involved in the reaction as a function of time. The consumption determinant can be calculated based on the consumption flow graph and is represent as

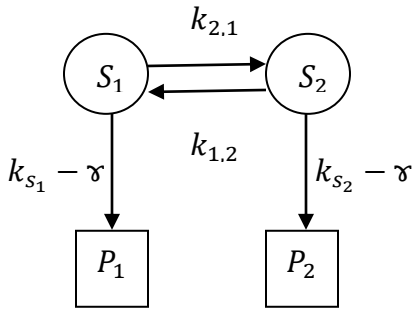

Figure 4: The Consumption Flow Graph for Two Species Reacting System (Vlase, 2008)

The consumption determinant for the above-mention flow graph is given by

$$\Delta C = \begin{matrix} & S_1 & S_2 \\ \begin{matrix} S_1 \\ S_2 \end{matrix} & \begin{vmatrix} k_{2,1} + k_{s_1} - \tau & -k_{1,2} \\ -k_{2,1} & k_{1,2} + k_{s_2} - \tau \end{vmatrix} \end{matrix}.$$

The values of γ are determined by making $\Delta C = 0$. The resulting expression is shown below.

$$\Delta C = (k_{2,1} + k_{s_1} - \gamma)(k_{1,2} + k_{s_2} - \gamma) - (k_{21}k_{12}) = 0.$$

If $k_{s_1} = k_{s_2} = 0$, the expression for the ΔC is

$$\gamma^2 - \gamma(k_{2,1} + k_{1,2}) = 0.$$

Then, the γ values are

$$\gamma_1 = 0; \gamma_2 = k_{2,1} + k_{1,2} \text{ or } \gamma_1 = k_{2,1} + k_{1,2}; \gamma_2 = 0.$$

Assume that the consumption determinant is not equal to zero.

$$\Delta(\gamma_i) = \prod_{\substack{j=1 \\ i \neq j}}^n (\gamma_j - \gamma_i) \neq 0.$$

The consumption determinant can be defined as the main determinant in the system which is the image of equivalent mechanism. It describes on the loss in all variables values and a gain of the output values as the substances is transforming to the final product. Meanwhile, the formation flow graph explains on the formation that occurs throughout the system and a gain of a variable starting from the input node which is the source (F).

4.1.2 Formation Flow Graph

The formation flow graph is represented from the consumption flow graph with the consideration the interest species being a target one and by adding a new source input.

- i) The formation flow graph for the reactant S_1 can be represented as

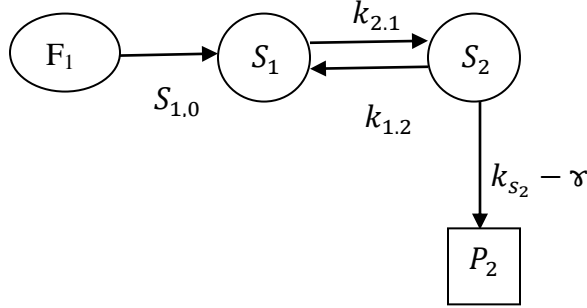

Figure 5: The Formation Flow Graph for Two Species Reacting System (Reactant S_1)

Then, the determinant for the formation flow graph is given by:

$$\Delta f_{S_1} = \begin{matrix} F & S_2 \\ S_1 & \left| \begin{array}{cc} S_{1,0} & -k_{1,2} \\ 0 & k_{1,2} + k_{S_2} - r \end{array} \right| \\ S_2 & \end{matrix}.$$

Where $k_{S_2} = 0$,

This result

$$\Delta f_{S_1}(r_1) = S_{1,0}(k_2 - r_1).$$

It results in:

$$A_{1,1} = \frac{\Delta f_{S_1}(r_1)}{\Delta C(r_1)} = \frac{S_{1,0}(k_{1,2} - r_1)}{(r_2 - r_1)}$$

$$A_{1,2} = \frac{\Delta f_{S_1}(r_2)}{\Delta C(r_2)} = \frac{S_{1,0}(k_{1,2} - r_2)}{(r_1 - r_2)}.$$

i) The formation flow graph for the product S_2 can be represented as

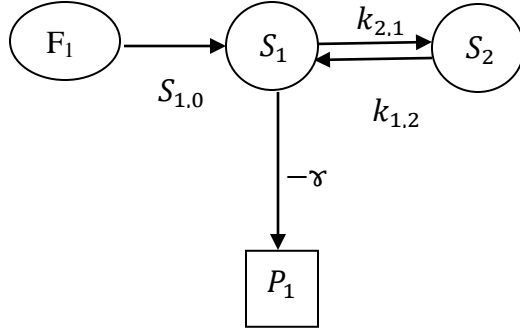

Figure 6: The Formation Flow Graph for Two Species Reacting System (Product S_2)

The determinant for the formation flow graph is given

$$\Delta f_{S_2}(\gamma) = \begin{matrix} S_1 & F \\ S_2 & \begin{vmatrix} k_{2,1} - \gamma & S_0 \\ -k_{2,1} & 0 \end{vmatrix} \end{matrix}.$$

This results the following expression

$$\Delta f_{S_2}(\gamma_i) = S_{1,0} k_{2,1}.$$

Then, the constant

$$A_{2,1} = \frac{\Delta f_{S_2}(\gamma_1)}{\Delta C(\gamma_1)} = \frac{S_{1,0}(k_{2,1})}{(\gamma_2 - \gamma_1)}$$

$$A_{2,2} = \frac{\Delta f_{S_2}(\gamma_1)}{\Delta C(\gamma_1)} = \frac{S_{1,0}(k_{2,1})}{(\gamma_1 - \gamma_2)}.$$

The analytical solution for the reactant S_1 and product S_2

$$C_{S_1}(t) = \frac{S_{1,0}}{(k_{2,1} + k_{1,2})} (k_{1,2} + k_{2,1} \exp((-k_{2,1} + k_{1,2})t))$$

$$C_{S_2}(t) = \frac{S_{1,0}(k_1)}{(k_{2,1} + k_{1,2})} (1 - \exp((-k_{2,1} + k_{1,2})t)).$$

The time evolution of molar concentration S_1 and S_2 are show in Figure 7 for the initial concentration of S_1 is 1 mol/m^3 and the kinetic constants $k_{2,1}$ and $k_{1,2}$ are 1.2 and 0.3 respectively.

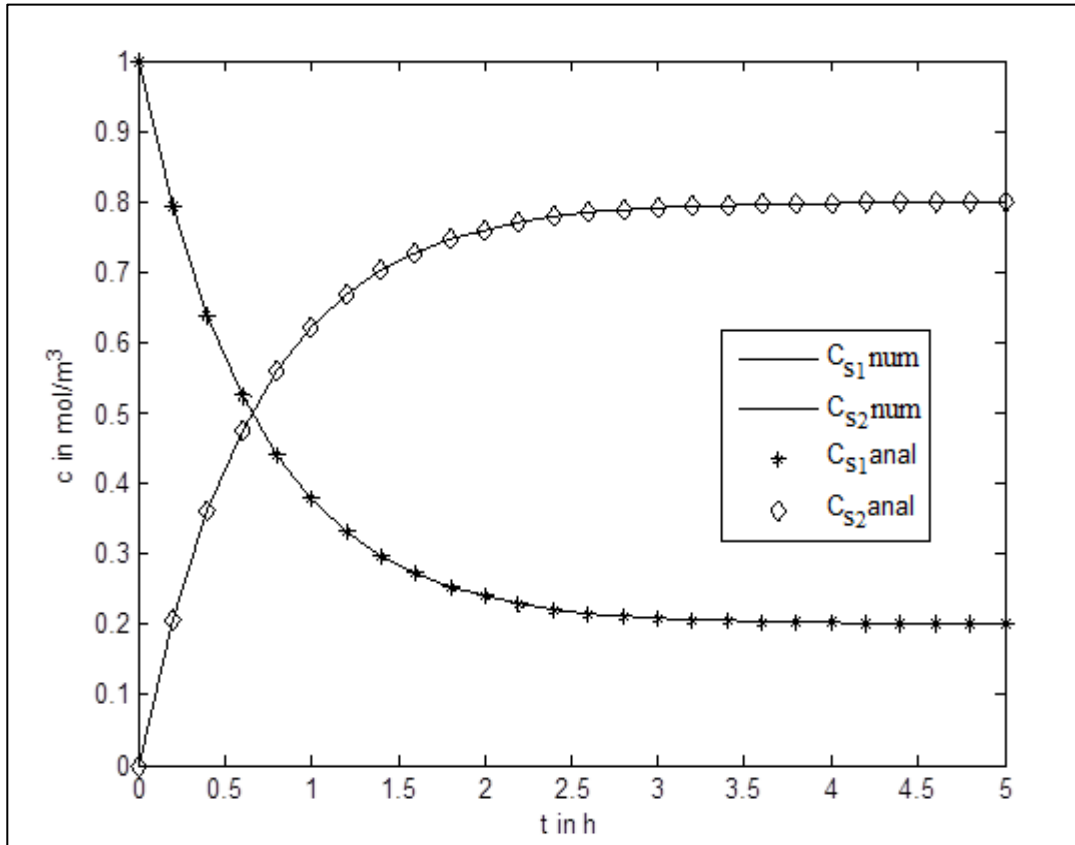

Figure 7: Concentration-Time Curves for Two Species Reacting System

Where:

Num = numerical solution,

Anal = analytical solution.

From the graph in Figure 7, it can be seen that the analytical solution is verified in the numerical integration of the kinetic equation using ODE45 solver. The ODE45 solver will solve the numerical solution by defining the initial value separately and the range for which the differential equations are solved within the function. Meanwhile, in order to find the analytical solution, the analytical values will be put manually. Then, it was observed that both solutions are consistent.

4.2 Analytical Solution For The Three Species Reacting System

The stoichiometry for the three species reacting system can be represented as:

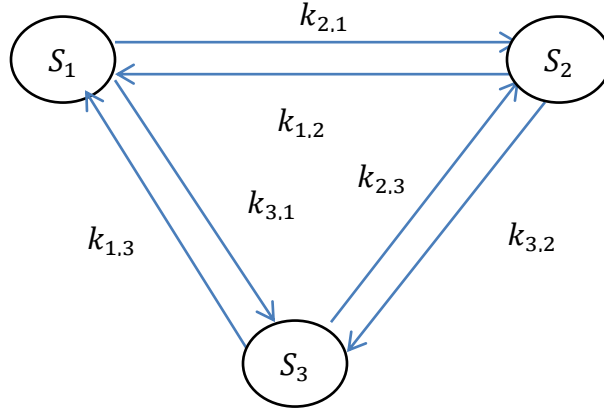

Figure 8: Kinetic Model For Three Species Reacting System

It was assumed that the reaction occurs in the constant-volume batch reactor. The rate of disappearance of reactant S_1 and production S_2 and S_3 are

$$r_{S_1} = -(k_{2,1} + k_{3,1})C_{S_1} + k_{1,2}C_{S_2} + k_{1,3}C_{S_3}$$

$$r_{S_2} = k_{2,1}C_{S_1} - (k_{1,2} + k_{3,2})C_{S_2} + k_{2,3}C_{S_3}$$

$$r_{S_3} = k_{3,1}C_{S_1} + k_{3,2}C_{S_2} - (k_{1,3} + k_{2,3})C_{S_3}.$$

The mole balance equations for the species S_1 , S_2 and S_3 are

$$\frac{dC_{S_1}}{dt} = -(k_{2,1} + k_{3,1})C_{S_1} + k_{1,2}C_{S_2} + k_{1,3}C_{S_3}$$

$$\frac{dC_{S_2}}{dt} = k_{2,1}C_{S_1} - (k_{1,2} + k_{3,2})C_{S_2} + k_{2,3}C_{S_3}$$

$$\frac{dC_{S_3}}{dt} = k_{3,1}C_{S_1} + k_{3,2}C_{S_2} - (k_{1,3} + k_{2,3})C_{S_3}.$$

The analytical solution for the three species reacting system can be represent:

$$C_{S_i}(t) = \sum_{j=1}^{N_s} A_{i,j} \exp(-\tau_j t).$$

Where $A_{i,j} = \frac{\Delta f_{S_i}(\gamma_j)}{\Delta C_{S_i}(\gamma_j)}$; $i = 1, 2, \dots, N_s$.

4.2.1 Consumption Flow Graph

The consumption flow graph theory for the three species reacting system is developed by adding the formation of the final products with the zero kinetic constants. It is shown in Figure 9.

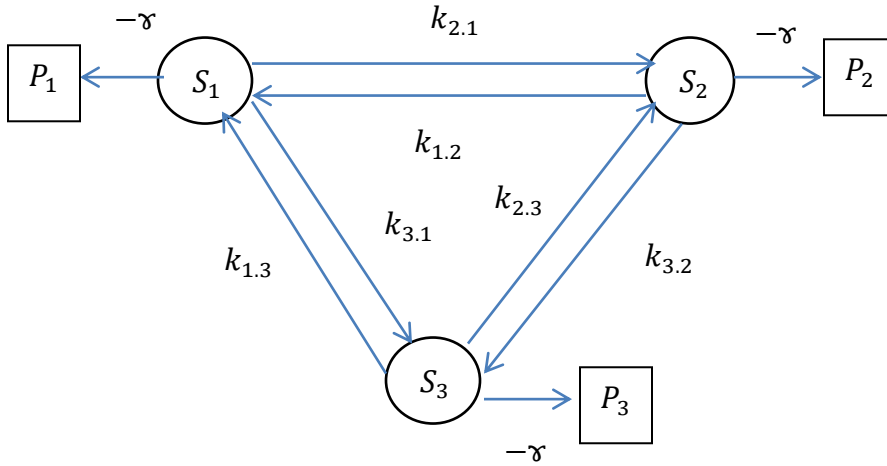

Figure 9: The Consumption Flow Graph For Three Species Reacting System

The consumption determinant for the three species reacting system is

$$\Delta C = \begin{array}{c} S_1 \\ S_2 \\ S_3 \end{array} \left| \begin{array}{ccc} k_{2,1} + k_{3,1} - \gamma & -k_{1,2} & -k_{1,3} \\ -k_{2,1} & k_{1,2} + k_{3,2} - \gamma & -k_{2,3} \\ -k_{3,1} & -k_{3,2} & k_{1,2} + k_{3,2} - \gamma \end{array} \right| .$$

After expanding the determinant, the following expression is obtained with rearrangement

$$\Delta C = -\gamma^3 + \gamma^2(k_{2,1} + k_{1,2} + k_{3,1} + k_{1,3} + k_{3,2} + k_{2,3}) - \gamma(k_{2,1}k_{1,3} + k_{1,2}k_{1,3} + k_{3,2}k_{1,3} + k_{2,1}k_{2,3} + k_{3,1}k_{2,3} + k_{1,2}k_{2,3} + k_{2,1}k_{3,2} + k_{3,1}k_{1,2} + k_{3,1}k_{3,2}) = 0.$$

The roots of the equation are

$$\Delta C = -\gamma(-\gamma^2(k_{2,1} + k_{1,2} + k_{3,1} + k_{1,3} + k_{3,2} + k_{2,3}) + \gamma(k_{2,1}k_{1,3} + k_{1,2}k_{1,3} + k_{3,2}k_{1,3} + k_{2,1}k_{2,3} + k_{3,1}k_{2,3} + k_{1,2}k_{2,3} + k_{2,1}k_{3,2} + k_{3,1}k_{1,2} + k_{3,1}k_{3,2})) = 0$$

$$\gamma_1=0; \gamma_2 = \frac{a+\sqrt{a^2-4b}}{2}; \gamma_3 = \frac{a-\sqrt{a^2-4b}}{2}.$$

Where $a = \gamma_2 + \gamma_3$ and $b = \gamma_2\gamma_3$.

4.2.2 Formation Flow Graph

The formation flow graph of the reactant S_1 is depicted in Figure 10.

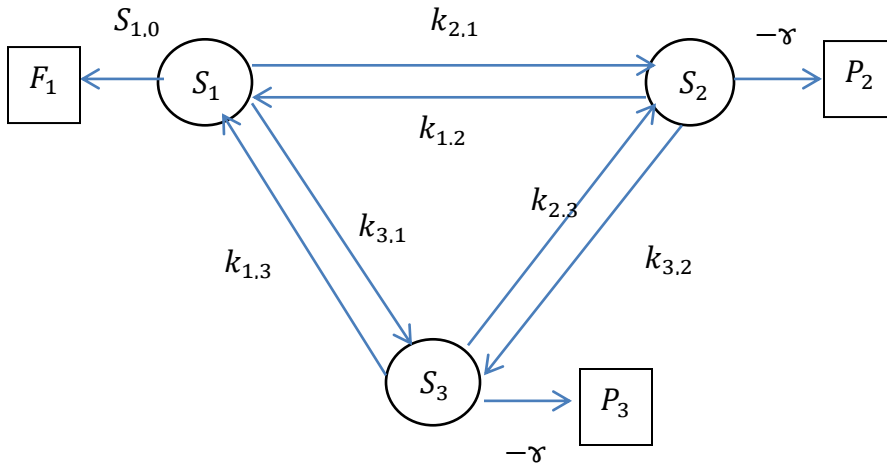

Figure 10: The Formation Flow Graph for Three Species Reacting System (Reactant S_1)

The determinant for the above mentioned formation flow graph is

$$\Delta f_{S_1} = \begin{matrix} & F_1 & S_2 & S_3 \\ \begin{matrix} S_1 \\ S_2 \\ S_3 \end{matrix} & \left| \begin{array}{ccc} S_{1,0} & -k_{1,2} & -k_{1,3} \\ 0 & k_{1,2} + k_{3,2} - \gamma & -k_{2,3} \\ 0 & -k_{3,2} & k_{1,2} + k_{3,2} - \gamma \end{array} \right| \end{matrix} .$$

It results

$$\Delta f_{S_1}(\gamma_i) = S_{1,0}(\gamma_i^2 - \alpha\gamma_i + \beta).$$

$$\text{Where } \alpha = k_{1,2} + k_{1,3} + k_{3,2} + k_{2,3};$$

$$\beta = k_{1,2}k_{1,3} + k_{3,2}k_{1,3} + k_{1,2}k_{2,3}.$$

The formation flow graph of the product S_2 is shown in Figure 11.

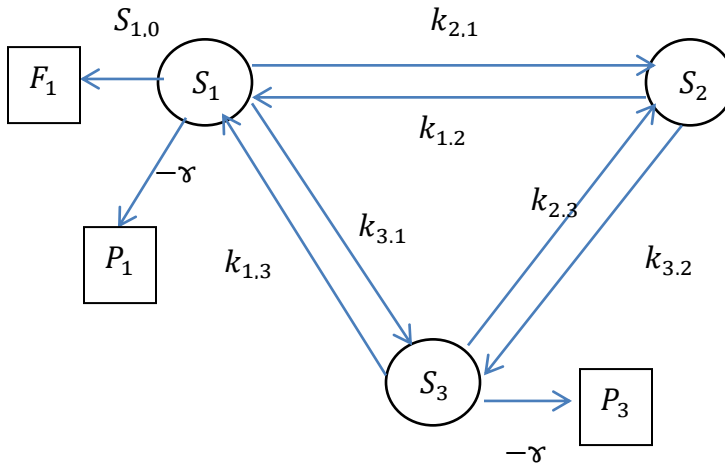

Figure 11: The Formation Flow Graph for Three Species Reacting System (Product S_2)

The determinant for the formation flow graph is

$$\Delta f_{S_2} = \begin{vmatrix} S_1 & F & S_3 \\ k_{2,1} + k_{3,1} - \gamma & S_{1,0} & -k_{1,3} \\ -k_{2,1} & 0 & -k_{2,3} \\ -k_{3,1} & 0 & k_{1,2} + k_{3,2} - \gamma \end{vmatrix}.$$

It results

$$\Delta f_{S_2}(\gamma_i) = S_{1,0}(\epsilon - k_{2,1}\gamma_i).$$

$$\text{Where } \epsilon = k_{2,1}k_{1,3} + k_{2,1}k_{2,3} + k_{3,1}k_{2,3}.$$

The formation flow graph of the product S_2 is depicted in Figure 12.

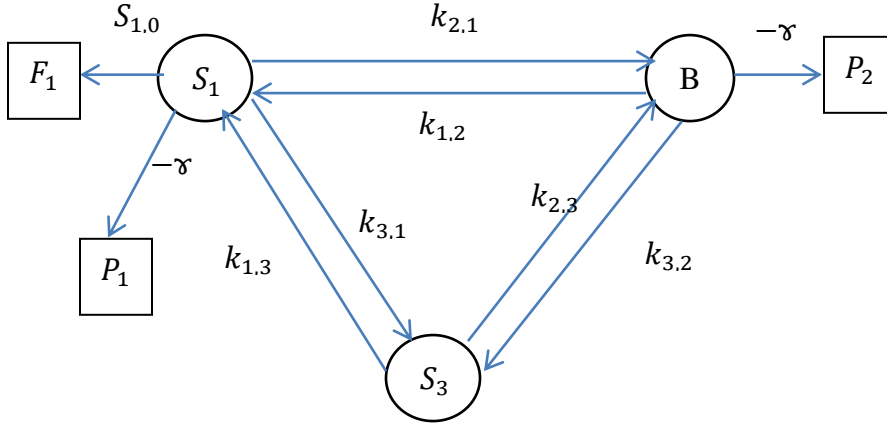

Figure 12: The Formation Flow Graph for Three Species Reacting System (Product S_3)

The determinant for the above mentioned formation flow graph is

$$\Delta f_{S_3} = S_2 \begin{vmatrix} S_1 & S_2 & F \\ k_{2,1} + k_{3,1} - \gamma & -k_{1,2} & S_{1,0} \\ -k_{2,1} & k_{1,2} + k_{3,2} - \gamma & 0 \\ -k_{3,1} & -k_{3,2} & 0 \end{vmatrix}.$$

It results

$$\Delta f_{S_3}(\gamma_i) = S_{1,0}(\delta - k_{3,1}\gamma_i).$$

$$\text{Where } \delta = k_{2,1}k_{3,2} + k_{3,1}k_{1,2} + k_{3,1}k_{3,2}.$$

Finally, the analytical solution for species S_1 , S_2 and S_3 are;

$$C_{S_1}(t) = S_{1,0} \left(\frac{\beta}{\gamma_2\gamma_3} + \frac{\alpha\gamma_2 - \gamma_2^2 - \beta}{\gamma_2(\gamma_3 - \gamma_2)} \exp(-\gamma_2 t) + \frac{\gamma_3^2 - \alpha\gamma_3 + \beta}{\gamma_3(\gamma_3 - \gamma_2)} \exp(-\gamma_3 t) \right)$$

$$C_{S_2}(t) = S_{1,0} \left(\frac{\epsilon}{\gamma_2 \gamma_3} + \frac{k_{2,1} \gamma_2 - \epsilon}{\gamma_2 (\gamma_3 - \gamma_2)} \exp(-\gamma_2 t) + \frac{\epsilon - k_{2,1} \gamma_3}{\gamma_3 (\gamma_3 - \gamma_2)} \exp(-\gamma_3 t) \right)$$

$$C_{S_3}(t) = S_{1,0} \left(\frac{\delta}{\gamma_2 \gamma_3} + \frac{k_{3,1} \gamma_2 - \delta}{\gamma_2 (\gamma_3 - \gamma_2)} \exp(-\gamma_2 t) + \frac{\delta - k_{3,1} \gamma_3}{\gamma_3 (\gamma_3 - \gamma_2)} \exp(-\gamma_3 t) \right).$$

Where

$$\gamma_1=0; \gamma_2 = \frac{a+\sqrt{a^2-4b}}{2}; \gamma_3 = \frac{a-\sqrt{a^2-4b}}{2}$$

$$\gamma_2 + \gamma_3 = a = k_{2,1} + k_{1,2} + k_{3,1} + k_{1,3} + k_{3,2} + k_{2,3} = \alpha + k_{2,1} + k_{3,1};$$

$$\gamma_2 \gamma_3 = b = k_{2,1} k_{1,3} + k_{1,2} k_{1,3} + k_{3,2} k_{1,3} + k_{2,1} k_{2,3} + k_{3,1} k_{2,3} + k_{1,2} k_{2,3} + k_{2,1} k_{3,2} + k_{3,1} k_{1,2} + k_{3,1} k_{3,2} = \beta + \epsilon + \delta;$$

$$\alpha = k_{1,2} + k_{1,3} + k_{3,2} + k_{2,3};$$

$$\beta = k_{1,2} k_{1,3} + k_{3,2} k_{1,3} + k_{1,2} k_{2,3}$$

$$\epsilon = k_{2,1} k_{1,3} + k_{2,1} k_{2,3} + k_{3,1} k_{2,3}$$

$$\delta = k_{2,1} k_{3,2} + k_{3,1} k_{1,2} + k_{3,1} k_{3,2}.$$

Then, three expressions are solved to determine how the molar concentration of the species S_1 , S_2 and S_3 change with respect to time with the following parameters. Initial concentration of S_1 is 1 mol/m^3 . The kinetics constant values are $k_{1,2} = 1.2$, $k_{2,1} = 0.12$, $k_{3,2} = 0.56$, $k_{2,3} = 0.01$, $k_{3,1} = 0.25$ and $k_{1,3} = 0.05$.

The time evolution of molar concentration of the species S_1 , S_2 and S_3 are shown in Figure 13.

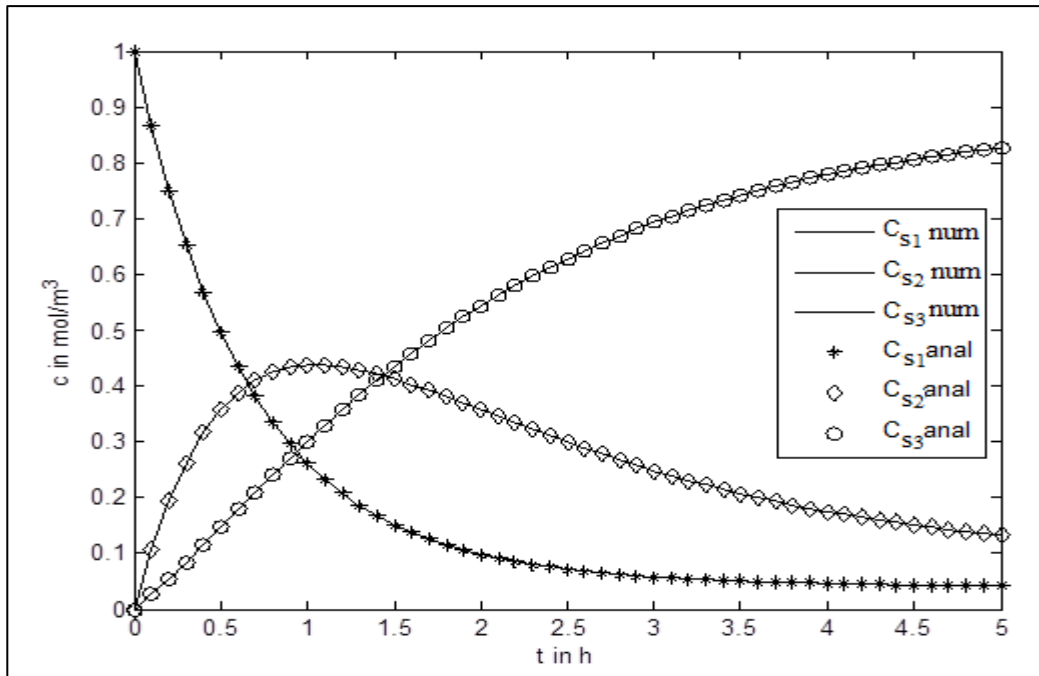

Figure 13: Concentration-Time Curves for Three Species Reacting System

Where:

Num = numerical solution,

Anal = analytical solution.

From the graph in Figure 13, it can be seen that the analytical solution is verified in the numerical integration of the kinetic equation using ODE45 solver which is available in the MATLAB software. The ODE45 solver will solve the numerical solution by defining the initial value separately and the range for which the differential equations are solved within the function. Meanwhile, in order to find the analytical solution, the analytical values will be put manually. Then, it was observed that both solutions are consistent

CHAPTER 5

CONCLUSION

In this paper, the analytical solutions for the first order reversible reaction systems are derived using flow graph theory approach. This method is demonstrated for the two and three species reacting systems. It is more simpler as it is only solving the consumption and formation determinants instead of writing the homogeneous or non-homogeneous linear differential equations. Flow graph theory eliminates the usage of Laplace transforms and eigenvalue methods for the analytical solution of simple first order reversible reaction systems. Then, it is verified by the ODE45 that the analytical solution is consistent with the numerical solution for the two and three species reacting series.

REFERENCES

- Bhusare, V.H., Balasubramanian, P. 2010, A New Paradigm in Kinetic Modeling of Complex Reaction Systems, *International Review on Modeling and Stimulation (I.RE.MO.S)*, Vol xx,n.x.
- Bursten, B.L. 2003, Chemistry The Central of Science, Ninth Edition, Prentice Hall, United States.
- Chemical Equilibrium, 23rd June 2012, <http://www.saskschools.ca/curr_content/chem30_05/3_equilibrium/equil_1_1.htm>
- Chrastil, J. 1993, Determination of the first-order consecutive reversible reaction kinetics. *Comp. Chem.*, 17(1), 103-106.
- Chu C. 1971. A Generalized Stochastic Model For Systems Of First-Order Reactions-Probability Generating Function Approach. *Chem. Eng. Sci.*, 26, 1651-1658.
- Connors, K.A. 1990, Chemical Kinetics: The Study of Reactions Rate in Solutions John Wiley & Sons, Inc., United States.
- Frost, A.A. and Pearson, R.G. 1961. Kinetics And Mechanism, Second Edition, John Wiley & Sons, Inc., New York.
- Korobov, V. I.; Ochkov, V. F. 2011, Chemical kinetics with Mathcad and Maple. Springer-Verlag. ISBN: 978-3-7091-0530-6, 35-72.

Levelspiel, O. 1999, Chemical Reaction Engineering, Third Edition, John Wiley & Sons, Inc., United States.

Matlab, 23rd June 2012 <<http://www.math.utah.edu/lab/ms/matlab/matlab.html>>

Pogliani, L., Santos, M. N. B., Martinho, J. M. G, **1996**, Matrix and convolution method in chemical kinetics. *J. Math. Chemistry*, 20, 193 - 210.

Smith, R. 2005, Chemical Process Design And Integration, John Wiley & Sons, Inc., United States.

Socol, M., Baldea I. 2009, New Method of Finding The Analytical Solutions Directly On The Base On The Reaction Mechanism, *J Math Chem*, Vol. 45 (Issue 2): 478-487.

Socol, M., Baldea, I. 2006. A New Approach of Flow Graph Theory Applied in Physical Chemistry, *Journal of the Chinese Chemical Society*, 53, 773-781.

Vlase, L., Socol, M., Baldea, I., Leucuta, S. and Ciurte, L. 2008, A New Graphical Method to Solving Homogenous Differential Equation Systems Used in Pharmacokinetic Analysis, *Revue Roumaine de Chimie*, 53(4), 297–302.

APPENDICES

APPENDIX 1: MATLAB CODING FOR THE TWO SPECIES REACTING SERIES

```
% first order reversible reaction system A<--->B
clc % clear the command window
clear all % clear the previous work space
global k
k = [1.2 0.3];
c0 = [1 0];
tspan =[0:0.2:5];
% Numerical solution
[t,c]=ode45(@rever_firsteq,tspan,c0);
figure(1);
plot(t,c,'k')
xlabel('t in h')
ylabel('c in mol/m^3')
hold on
figure(2);
plot(t,c(:,1),'k')
xlabel('t in h')
ylabel('cA in mol/m^3')
hold on
figure(3);
plot(t,c(:,2),'k')
xlabel('t in h')
ylabel('cB in mol/m^3')
hold on
% analytical solution
[nr, nc]=size(tspan);
for i = 1: nc
```

```

i
cA(i) = (c0(1)/(k(1)+k(2)))*(k(2)+k(1)*exp(-(k(1)+k(2))*tspan(i)));
cB(i) = ((c0(1)*k(1))/(k(1)+k(2)))*(1-exp(-(k(1)+k(2))*tspan(i)));
end
figure(1);
plot(t,cA,'*k')
plot(t,cB,'dk')
figure(2);
plot(t,cA,'*k')
figure(3);
plot(t,cB,'dk')
output = [t c cA' cB']

```

APPENDIX 2: MATLAB CODING FOR THE THREE SPECIES REACTING SERIES

```
% first order reversible reaction system A<--->B<---->C, A<----->C
clc % clear the command window
clear all % clear the previous work space
global k
k = [1.2 0.12 0.56 0.01 0.25 0.05];
c0 = [1 0 0];
tspan = [0:0.1:5];
% Numerical solution
[t,c]=ode45(@rev_threecom_eq,tspan,c0);
% output =[t c]
figure(1);
plot(t,c,'k')
xlabel('t in h')
ylabel('c in mol/m^3')
hold on
figure(2);
plot(t,c(:,1),'k')
xlabel('t in h')
ylabel('cA in mol/m^3')
hold on
figure(3);
plot(t,c(:,2),'k')
xlabel('t in h')
ylabel('cB in mol/m^3')
hold on
figure(4);
plot(t,c(:,3),'k')
xlabel('t in h')
```

```

ylabel('cC in mol/m^3')
hold on
% analytical solution
[nr, nc]=size(t);
t
calp = k(2)+k(3)+k(4)+k(6);
cbet = k(2)*k(6)+k(2)*k(4)+k(3)*k(6);
ceps = k(1)*k(6)+k(1)*k(4)+k(4)*k(5);
cdel = k(1)*k(3)+k(5)*k(2)+k(5)*k(3);
a = calp+k(1)+k(5);
b = cbet+ceps+cdel;
cgam1 = 0;
cgam2 = (a+realsqrt(a^2-4*b))/2;
cgam3 = (a-realsqrt(a^2-4*b))/2;
for i = 1: nr
    cA(i) = c0(1)*((cbet/(cgam2*cgam3))+((calp*cgam2-(cgam2)^2-cbet)/...
        (cgam2*(cgam3-cgam2))))*exp(-cgam2*t(i))+ ...
        (((cgam3)^2-calp*cgam3+cbet)/(cgam3*(cgam3-cgam2)))*...
        exp(-cgam3*t(i)));
    cB(i) = c0(1)*((ceps/(cgam2*cgam3))+((k(1)*cgam2-ceps)/(cgam2*...
        (cgam3-cgam2))))*exp(-cgam2*t(i))+ ...
        ((ceps-k(1)*cgam3)/(cgam3*(cgam3-cgam2)))*...
        exp(-cgam3*t(i)));
    cC(i) = c0(1)*((cdel/(cgam2*cgam3))+((k(5)*cgam2-cdel)/(cgam2*...
        (cgam3-cgam2))))*exp(-cgam2*t(i))+ ...
        ((cdel-k(5)*cgam3)/(cgam3*(cgam3-cgam2)))*...
        exp(-cgam3*t(i)));
end
figure(1);
plot(t,cA,'*k')
plot(t,cB,'dk')

```



```

plot(t,cC,'ok')
figure(2);
plot(t,cA,'*k')
figure(3);
plot(t,cB,'dk')
figure(4);
plot(t,cC,'pk')
output = [t c cA' cB' cC'] % first order reversible reaction system A<--->B<---->C, A<--
-->C
clc % clear the command window
clear all % clear the previous work space
global k
k = [1.2 0.12 0.56 0.01 0.25 0.05];
c0 = [1 0 0];
tspan =[0:0.1:5];
% Numerical solution
[t,c]=ode45(@rev_threecom_eq,tspan,c0);
% output =[t c]
figure(1);
plot(t,c,'k')
xlabel('t in h')
ylabel('c in mol/m^3')
hold on
figure(2);
plot(t,c(:,1),'k')
xlabel('t in h')
ylabel('cA in mol/m^3')
hold on
figure(3);
plot(t,c(:,2),'k')
xlabel('t in h')

```

```

ylabel('cB in mol/m^3')
hold on
figure(4);
plot(t,c(:,3),'k')
xlabel('t in h')
ylabel('cC in mol/m^3')
hold on
% analytical solution
[nr, nc]=size(t);
t
calp = k(2)+k(3)+k(4)+k(6);
cbet = k(2)*k(6)+k(2)*k(4)+k(3)*k(6);
ceps = k(1)*k(6)+k(1)*k(4)+k(4)*k(5);
cdel = k(1)*k(3)+k(5)*k(2)+k(5)*k(3);
a = calp+k(1)+k(5);
b = cbet+ceps+cdel;
cgam1 = 0;
cgam2 = (a+realsqrt(a^2-4*b))/2;
cgam3 = (a-realsqrt(a^2-4*b))/2;
for i = 1: nr
    cA(i) = c0(1)*((cbet/(cgam2*cgam3))+((calp*cgam2-(cgam2)^2-cbet)/...
        (cgam2*(cgam3-cgam2))))*exp(-cgam2*t(i))+ ...
        (((cgam3)^2-calp*cgam3+cbet)/(cgam3*(cgam3-cgam2)))*...
        exp(-cgam3*t(i)));
    cB(i) = c0(1)*((ceps/(cgam2*cgam3))+((k(1)*cgam2-ceps)/(cgam2*...
        (cgam3-cgam2))))*exp(-cgam2*t(i))+ ...
        ((ceps-k(1)*cgam3)/(cgam3*(cgam3-cgam2)))*...
        exp(-cgam3*t(i)));
    cC(i) = c0(1)*((cdel/(cgam2*cgam3))+((k(5)*cgam2-cdel)/(cgam2*...
        (cgam3-cgam2))))*exp(-cgam2*t(i))+ ...
        ((cdel-k(5)*cgam3)/(cgam3*(cgam3-cgam2)))*...

```

```
        exp(-cgam3*t(i));  
end  
figure(1);  
plot(t,cA,'*k')  
plot(t,cB,'dk')  
plot(t,cC,'ok')  
figure(2);  
plot(t,cA,'*k')  
figure(3);  
plot(t,cB,'dk')  
figure(4);  
plot(t,cC,'pk')  
output = [t c cA' cB' cC']
```