

CERTIFICATION OF APPROVAL

Location Based Reminder System: L-Minder System

By

Muhammad Fitri Bin Husin

Dissertation submitted in partial fulfillment of
the requirement for the
Bachelor of Technology (Hons)
(Information Communication Technology)

Approved By,

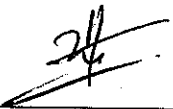

Mr. Mohd Hilmi Hasan

UNIVERSITI TEKNOLOGI PETRONAS

TRONOH, PERAK

NOVEMBER 2006

CERTIFICATION OF ORIGINALITY

This is to certify that I am responsible for the work submitted in this project, that the original work is my own except as specified in the references and acknowledgements, and that the original work contain herein have not been undertaken or done by unspecified sources or persons.

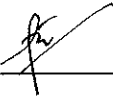

MUHAMMAD FITRI BIN HUSIN

4586

TABLE OF CONTENTS

CERTIFICATION OF APPROVAL.....	ii
CERTIFICATION OF ORIGINALITY.....	iii
ACKNOWLEDGEMENT.....	iv
ABSTRACT.....	vi
LIST OF FIGURES.....	viii
LIST OF TABLES.....	ix
ABBREVIATIONS.....	x
CHAPTER 1: INTRODUCTION	
1.1 Background of Study.....	1
1.2 Problem Statement	
1.2.1 Problem Identification.....	4
1.2.2 Significant of the Project.....	4
1.3 Objective and Scope of Study	
1.3.1 The Relevancy of the Project.....	5
1.3.2 Feasibility of the Project within the Scope and Timeframe.....	6
CHAPTER 2: LITERATURE REVIEW AND / OR THEORY.....	8
CHAPTER 3: METHODOLOGY / PROJECT WORK	
3.1 Procedure Identification.....	13
3.2 Tools required.....	14

3.3 Installation of Symbian Series 60 2 nd Edition.....	15
3.4 Familiarization and using Symbian.....	15
3.5 Installation of NetBeans 4.1 and JSR 179	16

CHAPTER 4: RESULTS AND DISCUSSION

4.1 Data Gathering and Analysis.....	18
4.2 Results and Discussion.....	18
4.3 Selection of Cell Id as location detection method.....	23
4.4 Development of the L-Minder System.....	26
4.5 Location detection by getting current Cell Id.....	26
4.6 Triggering the alarm based on Cell Id match.....	27
4.7 Accuracy issue using GSM Cell Id.....	28

CHAPTER 5: CONCLUSION.....32

REFERENCES.....33

APPENDICES.....34

ACKNOWLEDGEMENT

Thank you All Mighty Allah for lending me the strength to complete this Final Report and above all completing the Final Year Project (FYP) Part One and Part Two. This page is dedicated to give my fullest appreciation and thank you to all the people involved directly or indirectly during two semester's period of Final Year Project (FYP) Part One and Part Two.

First and foremost, my greatest thank you goes to my Final Year Project (FYP) Supervisor, Mr Mohd Hilmi Hasan, for offering me his supervision under the Networking Group of the Information Communication Technology Department. He was a very kind, supportive and highly motivated supervisor who monitored my progress as his supervisee along the two semester period. Without his kindness and support, I think I would not be able to successfully complete Final Year Project in UTP and be the person that I am now. He showed flexibility in the most correct way but at the same time made sure that I did not stray from the requirements given for example to complete and submit deliverables before deadline. All of the advice and motivation given by him changed some of my attitude aspect, allowing me to grow and stand where I am right now in terms of technical skills and soft skills.

Secondly, I would like to thank my parents for being so supportive during in my completion of my Final Year Project. They supported me all the way, in terms of motivation, financial and other important aspects.

Last but not least, to all of my friends who had been very contributive in terms of ideas, technical knowledge and keeping my morale always at the fullest level at all times.

ABSTRACT

A reminder plays an important role in every day life for everyone. People use various methods to remind themselves about daily tasks, events, meetings and etc. For example they use to-do list, stick notes, and date-time reminders in mobile phone. This research focuses on the development of location based reminder, a method of reminding people deployed on mobile phones. It implements the concept of context-aware in ubiquitous and is supported by location detection by GSM technologies. The project, L-Minder, will be an upgraded version of the existing time and date based reminder because of the location awareness and context awareness. The reminder will remind the users about the daily tasks, events, meetings and etc based on the desired location at which these events or tasks needed to be performed. Intensive research and literature review had been done in order to obtain as much useful information data to develop the project. Surveys had been done over a specific group of users to obtain data on preferences, dislikes and other important information regarding the development of the system. The project will solve many problems that arise from both time and date based reminder and the existing location based reminders in the market.

LIST OF FIGURES

Figure 1.1 Mobile Phones in Malaysia

Figure 1.2 Rapid Application Developments (RAD)

Figure 1.3 Gadget used by UTP students

Figure 1.4 Frequency of usage

Figure 1.5 Usage Purpose

Figure 1.6 Upgrade to location based reminder

Figure 1.7 Accuracy of the reminder

Figure 1.8 GSM network elements

Figure 1.9 The Timing Advance (TA) principle

Figure 2.0 Flow chart of the system

Figure 2.1: Timing Advance Principle

Figure 2.2: Mobile Station transition from one BTS to another

Figure 2.3: Advanced Timing Advance Method

Figure 2.4: Accurate location detection using Advanced Timing Advance principle

LIST OF TABLES

Table 1.1 L-Minder Work Break Structure (WBS) in Tabular Form

Table 1.2 Software requirements

Table 1.3 Hardware requirements

Table 1.4 Gadget used

ABBREVIATIONS

Abbreviations	Denotation
ATA	Advanced Timing Advance
BSC	Base Station Controller
BTS	Base Transceiver Station
GPS	Global Positioning System
GSM	Global System for Communication
HLR	Home Location Register
MS	Mobile Station
TDMA	Time Division Multiple Access
TA	Timing Advance

CHAPTER 1

INTRODUCTION

1. INTRODUCTION

1.1 Background of Study

Malaysia is being a country with over 23 million in population and 7.3 million mobile subscribers as of end 2001 (10). The numbers shows that usage of mobile phone is made common year by year and by various demographics of the users.

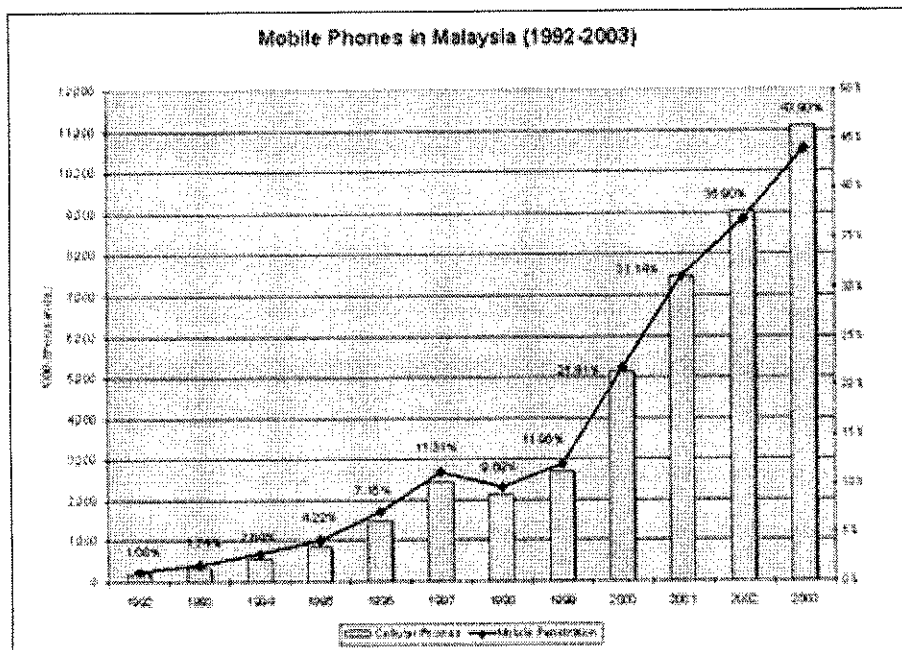

Figure 1.1 Mobile Phone usage in Malaysia

Aside from being able to perform normal tasks for example making calls, sending text messages, play games, browse WAP, one of the most famous functions of the mobile phone used by the users is the reminder function. Every mobile phone of every model for example Nokia, Siemens, Sony Ericson, and Sagem had made this function available as it is also considered a must for every mobile phone though the function can be classified as simple. The existing reminder system which reminds users based on

time and date of the event or task will be upgraded to being able to remind users based their current location. The background of the study will introduce and focus on the concept of ubiquitous, location based reminder and the usage of GSM technology for location detection to develop the Location Based Reminder System, a location based reminder system.

1.1.1 Ubiquitous

Ubiquitous computing, ubicomp, or sometimes called ubiqcomp integrates computation into the environment, rather than having computers which are distinct objects [1]. Other terms for ubiquitous computing include pervasive computing, calm technology, and things that think. Promoters of this idea hope that embedding computation into the environment and everyday objects would enable people to move around and interact with information and computing more naturally and casually than they currently do. One of the goals of ubiquitous computing is to enable devices to sense changes in their environment and to automatically adapt and act based on these changes based on user needs and preferences. The concept of ubiquitous is introduced in the background of study because the feature context-aware, contained in this concept, will be the core idea of developing the project. Context-aware computing [2] is the concept where the application will automatically adapts to discovered context, by changing application behavior. There are two types of context awareness, which is active context-aware and passive context-aware. To relate and implement the concept of ubiquitous and context-awareness, the application, the L-Minder, will automatically change its behavior by reminding the user's of their task each time the location reached (change of location).

1.1.2 Location Based Reminder

Location Based Reminders are reminder systems that use location detection technologies for example satellite Global Positioning System (GPS), Radio Frequency (RF) and Global System for Mobile Communication (GSM). With additional context-aware functionality which is to be able to remind based the user's current location,

location based reminder had been a popular attraction to mobile phone, PDA's and other mobile gadget's user. Some of the system had been also upgraded with Artificial Intelligence features (AI), for example to able to track and study user's movement pattern over time and to define the location for example Market Place and Office based on user's preferences.

1.1.3 GSM Technology

The Global System for Mobile Communications (GSM) [3] is the most popular standard for mobile phones in the world. GSM service is used by over 1.8 billion people across more than 210 countries and territories. The ubiquity of the GSM standard makes international roaming very common between mobile phone operators, enabling subscribers to use their phones in many parts of the world. GSM differs significantly from its predecessors in that both signaling and speech channels are digital, which means that it is considered a *second generation* (2G) mobile phone system. This fact has also meant that data communication was built into the system from very early on. GSM is an open standard which is currently developed by the 3GPP. From the point of view of the consumer, the key advantage of GSM systems has been higher digital voice quality and low cost alternatives to making calls such as text_messaging. The advantage for network operators has been the ability to deploy equipment from different vendors because the open standard allows easy inter-operability. Like other cellular standards GSM allows network operators to offer roaming services which mean subscribers can use their phones all over the world.

As the GSM standard continued to develop, it retained backward compatibility with the original GSM phones; for example, packet data capabilities were added in the Release '97 version of the standard, by means of GPRS. Higher speed data transmission has also been introduced with EDGE in the Release '99 version of the standard.

1.2 Problem Statement

1.2.1 Problem Identification

Currently, there are several location based reminder being developed, for example the CybreMinder system, the Place Mail system, the GeoMinder system and the Active Campus system. The approach user to implement this kind of reminder system differs from one another. For example, the ActiveCampus uses radio frequency (RF) for detecting the location, the ComMotion system uses satellite Global Positioning System (GPS) while the Geominder uses Global System for Mobile Communication (GSM) for location detection. All of these systems are deployed over and used on mobile phones.

The approach of developing location based reminder had eliminated and solved the problem of the generic reminder system, which only rely on time and date for reminding users. Above all, based on research and evaluation that had been done, these are several problem identified for the existing location based reminder system. The first addressed issue is to select which method is the best to be used as the location detection, based on the cost, effectiveness and accuracy factor. The second issue is related to how/which/what method is used to obtain the most accurate location of the user. Finally, the question of how well will the systems maintains the accuracy and adapt with the change of user's location based on their movement.

1.2.2 Significant of the Project

The solution provided by the L-Minder system will change life of the user. Users do not have to worry anymore if they forget to bring along their to-do list papers. Mobile phone is the gadget that will be brought along every time and every where. There will be no more plain text reminder that is not interactive. The system will use icons as to resemble places, for example market place, parking lot, school and office. Development of the system also runs along with research and development, therefore there will

always be room for improvement and enhancement, for example adding the feature of voice command reminder. The system design will be simple, yet usable, practical and user friendly.

1.3 Objective and Scope of Study

1.3.1 The Relevancy of the Project

The objective is to develop a system that will remind the user of their day to day task or events based on their current location. The increasing ability to both track people's movements and sense the environment combined with the growing ubiquity of mobile devices has lead to an exciting acceleration of research and development of location based reminder system.

Today we are witnessing an explosion in the use of mobile phone in both our personal and work lives. People will need to access information anywhere, anytime and on any device, and being reminded based on current location, is also one of the key aspect of accessing information. The combination of the acceptance of mobile work styles and more advanced technology has created a positive reinforcement pattern. As the demand for mobile technologies increases, the market responds with technological advances, and it is those very advances that drive demand or yet more sophisticated and integrated technologies.

In addition, the L-Minder system will help in improving the current system that we have in normal mobile phone reminder. It will provide a more efficient, user friendly and more effective reminder.

Besides, the implementation and field trial of this new system using innovative technologies is for a more flexible and more cost-effective for location based reminder.

1.3.2 Feasibility of the Project within Scope and Time Frame

In the project, Work Break Structure (WBS) is developed in providing the basis for deciding how to do work as well as creating the project schedule. Table 1.1 shows the L-Minder project Work Break Structure (WBS) in Tabular Form.

Table 1.1: L-Minder System Work Break Structure (WBS) in tabular form

1. Planning

1.1 Prepare Project Timeline

1.1.1 Identify Task

1.1.2 Determine Task Dependencies

1.1.3 Finalize Timeline

2. Executing

2.1 Information Gathering and Facts Finding

2.1.1 Search for Relevant Journal and Article

2.1.2 Search for Suitable Tools and Development Method

2.2 Prepare Preliminary Report

2.2.1 Background of Study

2.2.2 Identify Problem

2.2.3 Significant of the Project

2.2.4 Objective and Scope of Study

2.2.5 Methodology/Project Work

2.2.6 Conclusion

2.2.7 Prepare Abstract

2.2.8 Finalize Preliminary Report

2.2.9 Submit Preliminary Report

2.3 Analysis and Design

2.3.1 Prepare Logical Modeling

2.3.2 Prepare Conceptual Data Modeling

2.3.3 Interface design

2.3.4 Prepare Storyboard

4. Implementation

4.1 Installation of Development Tools

4.2 Develop Prototype

5. Presentation

5.1 Prepare Presentation Material

5.2 Revise and Practice for Presentation

5.3 Submission Interim Report

CHAPTER 2

LITERATURE REVIEW AND/OR THEORY

2. LITERATURE REVIEW AND/OR THEORY

2.1 The ComMotion system

The first system assessed was based on Global Positioning System (GPS) technology. The system evaluated was *commotion*. *ComMotion* [4] is a location-aware computing environment which links personal information to locations in its user's life; for example, *comMotion* reminds one of her shopping list when she nears a grocery store. Using satellite-based GPS position sensing, *comMotion* gradually learns about the locations in its user's daily life based on travel patterns. The full set of *comMotion* functionality, including map display, requires a graphical user interface.

A user's interaction with *comMotion* begins with the location-learning agent. It observes the user's frequented locations over time and allows them to be labeled. Once a location has been defined, a to-do list is associated with it. A to-do list is a set of text items or digital audio recordings; these may be ticked off once completed. When the user is in the relevant location, he will hear an auditory cue alerting him that he has items on the associated to-do list. In addition, other users can also send him reminders to his virtual locations. These reminders resemble the common 3M Postsits™ and can be sent via regular e-mail. The user can also subscribe to information services, such as headline news, weather reports and current movie listings; the subscription is per location and different schedules can be made for different days. For example, the user could request to receive a list of the movies showing at the local cinemas when leaving work on Fridays. In addition, *comMotion* can provide maps showing the user's current position together with neighborhood locales, such as banks, movie theatres or grocery stores. The data types and functionality of *comMotion* require a multi-modal user interface. Its alerting function reminds the user to; for example, buy milk when nearing a grocery store. Since we can rarely view a screen while traveling, this cue cannot be

visual so an auditory alert is used. Map information, on the other hand, is best displayed visually; although we have in the past explored giving driving directions by voice, this requires a detailed and up-to-date street database, not just maps. *comMotion*'s reminders are either voice or text. Although its graphical interface is more extensive, *comMotion*'s core functions are accessible by speech input to allow mobile use. *ComMotion*, with the appropriate hardware, and with some modifications in the software, could accommodate different architectures. A number of scenarios can be envisioned, each adapted for different life-styles, or different modes of mobility: a wearable on-the-go architecture for the highly active, such as, cyclists; car architecture for the more sedentary; briefcase architecture for the mobile individual, for example, knowledge workers; or a stripped down kids architecture. These are all variations on the same *comMotion* system, tailored to different needs. What changes is the hardware, the user interface and the features included in the system, which range from full-fledged to strip down variations. However, because it is intended primarily for mobile use, including driving, the core set of reminder creation and retrieval can be managed completely by speech.

2.2 The ActiveCampus system

The second system evaluated was the ActiveCampus [5]. ActiveCampus Explorer (ACE) client incorporates a variety of location-based services centered on the university life such as display of nearby buddies, activities, and sites, as well as digital graffiti. ActiveCampus also provides an interface for setting location-based reminders throughout the university. ActiveCampus relies on known 802.11 access points pervasive throughout the campus to provide room scale location sensing. The system is able to give a location estimate to the user as a place and position the user on a map for intuitiveness. Evaluating reminder usage with relatively high-accuracy system (accuracy fewer than 20m) permits the understanding on how accurate a system needs to be for location-based reminders to be useful without discouraging users from using the system.

2.3 Place-Its: A study of Location-Based Reminders on Mobile Phone

Place-Its [6] is designed around the post-it note usage metaphor, and named for its ability to “place” a reminder message at a physical location (i.e., a place). It usefully deviates from the metaphor in that notes can be posted to remote places. Although a person is home for the night, he can post a note at work to be retrieved the following morning upon arrival. The three components to a Place-It reminder note are the *trigger*, *text*, and *place*. The *trigger* identifies whether the reminder should be signaled upon arrival or departure of the associated *place*. The *text* is the message associated with the note. Reminders are created with a message, and then posted to a location on the person’s list of places. People could use the phone’s predictive text input for entering their reminder texts to ease the burden of typing on the phone’s keypad. A person can view all posted reminder notes at any time and can delete or edit any of the fields associated with the note. After a reminder note is posted on a place, when the trigger (arrival or departure) occurs, the note is automatically removed and put in the Removed Place-Its list. Once a note is removed, it can be edited, and reposted to the same or a different. The platform used to develop this system is Symbian Series 60 platform using Java 2 Micro edition using information from GSM tower to get the location of the user. There are three design concepts in Place-Its system. First, it must be an always-on service, to ensure that reminder notifications are always possible and users can have confidence that they will get their requested reminders. A reminder system that is only available a small percentage of a person’s day is ineffective if the message needs to be delivered outside the operational time frame. Second, the application must be easily deployable. Requiring people to carry extra pieces of hardware can hinder their integration of the reminder tool into their daily activities. The application is best deployed through a familiar artifact that people already use or carry on a daily basis. Lastly, the feature is set to be time-based reminder.

2.4 The PlaceMail system

The PlaceMail [7] system is a location based reminder system that uses the concept of sending mail to yourself, but with a twist. Instead of receiving the message in an email browser, you receive it on a cell phone at a time and place of your choice. A short tune alerts you to incoming mail. PlaceMail is implemented on Motorola i88 iDEN mobile phone, because it is used universally everyday. PlaceMail uses the phone's built in assisted GPS. A major design goal was to make it easy for people to create reminder messages, a challenge given the tedious process of text entry on mobile phones. Thus, while a phone interface for creating, and editing messages, two additional features are also provided. First, a web interface is designed with the same functionality as the phone interface. The web interface emulates the look and feel of an email browser. Second, a voice message function is implemented: users can optionally record voice reminders on the phone. Users can specify one or more delivery places for a message. For example, a user might associate a message "Check furnace filter prices" with several hardware stores. The message is delivered when the user is near any of the stores. Users can specify a delivery date and time instead of, or in addition to delivery place(s). When both place(s) and date/time are specified, PlaceMail "activates" the message at the given date/time. It then begins checking whether the user nears a specified place.

PlaceMail uses client-server architecture. PlaceMail stores user data (places and messages) in a database on a server. This enables easy synchronization between the phone and web-based clients. The phone client retrieves a user's places and current messages at login over a wireless HTTP connection. During active use, messages are stored locally on the phone. New or edited messages are pushed to the phone and web client every 60 seconds. Most important, the phone client takes GPS readings at frequent intervals (every minute) and sends this information to the server, where computations determine whether any messages are relevant to the user's current location. If so, they are delivered.

2.5 CyberMinder: A context-aware system for supporting reminders

The CyberMinder [8] system is a location based reminder system that is java-based tool. It consists of two parts which are the reminder creation and reminder delivery part.

Reminder Creation

When users launch CybreMinder, they are presented with an interface that looks quite similar to an e-mail creation tool. Users can enter the names of the recipients for the reminder. The recipients could just be themselves, indicating a personal reminder, or a list of other people, indicating a third party reminder is being created. The reminder has a subject, a priority level (ranging from lowest to highest), a body in which the reminder description is placed, and an expiration date. The expiration date indicates the date and time at which the reminder should expire and be delivered, if it has not already been delivered. In addition to this traditional messaging interface, users can select the Situation tab and be presented with the situation editor. This interface allows dynamic construction of an arbitrarily rich situation, or context that is associated with the reminder being created. Creation is assisted by a dynamically generated list of valid sub-situations that are currently supported by the CybreMinder infrastructure. When the user selects a sub-situation, they can edit it to fit their particular situation. Each sub-situation consists of a number of context types and values. The context types are the user's name, the location (set to CRB) and a timestamp.

Reminder Delivery

When a reminder can be delivered, either because its associated situation was satisfied or because it has expired, CybreMinder will determine what the most appropriate delivery mechanism for each recipient is. The default signal is to show the reminder on the closest available display, augmented with an audio cue. However, if a recipient wishes, they can specify a configuration file that will override this default. A user's configuration file contains information about all of the available methods for contacting the user, as well as rules defined by the user on which method to use in which situation. If the recipient's current context and reminder information (sender identity and/or priority) matches any situation defined in his configuration file, the specified delivery mechanism is used.

CHAPTER 3

METHODOLOGY/PROJECT WORK

3. METHODOLOGY/PROJECT WORK

3.1 Procedure Identification

In this project, Rapid Application Development (RAD) is chosen as the development methodology. RAD is a methodology for compressing the analysis, design, build, and test phases into a series of short, iterative development cycles (Refer Figure 1.6). This has a number of distinct advantages over the traditional sequential development model.

The traditional software development cycle follows a rigid sequence of steps with a formal sign-off at the completion of each step. A complete, detailed requirements analysis is done that attempts to capture the system requirements in a Requirements Specification. Users are forced to "sign-off" on the specification before development proceeds to the next step. This is followed by a complete system design and then development and testing.

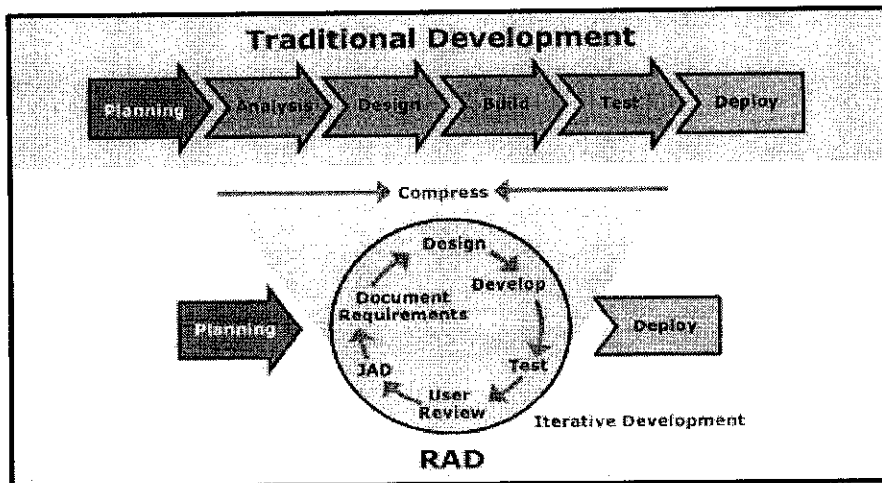

Figure 1.2 Rapid Application Developments (RAD)

Iteration allows for effectiveness and self-correction. Studies have shown that human beings almost never perform a complex task correctly the first time. However, people

are extremely good at making an adequate beginning and then making many small refinements and improvements.

3.2 Tool required

Several tools and scripting are listed in developing the L-Minder system (See Table 1.2 and Table 1.3).

Software	Minimum Requirement
Operating System	Window XP Service Pack 2
Supporting Software	Symbian Series 60 2 nd Edition SDK NetBeans 4.1 J2ME and JSR 179 (Location API for J2ME)
Programming Language	Symbian Java C++

Table 1.2 Software requirements

Hardware	Model	Reason of usage
Processor	Intel Pentium 4 or above	Compatible and stable
Main Memory	512 Megabytes(MB) or above	To support the Operating System and to improve performance
Nokia series 60 Mobile Phone and JSR 179 Compatible Phone	Nokia 7610, Nokia N80, Nokia 9500	To deploy and test the L-Minder system

Table 1.3 Hardware requirements

3.3 Installation of Symbian Series 60 2nd Edition

Last semester, a list of tools required consisting of both software and hardware to develop the L-Minder System is listed in Chapter 3: Methodology / Project Work. The chapter also stated that the supporting software will be Java 2ME (Micro Edition) and Symbian Series 60 2nd Edition Supporting Feature Pack 2, while the programming language to be used is either Java or Symbian C++. This semester (semester 2), Symbian Series 60 SDK 2nd Edition Supporting Feature Pack 2 and J2ME are selected to be the software for developing the L-Minder System using Symbian C++ and Java as the programming language. The decision was made after thorough research being done on using both Java 2ME (Micro Edition) and Symbian.

Symbian's major advantage is the fact that it was built for handheld devices, with limited resources, that may be running for months or years. There is a strong emphasis on conserving memory, using Symbian-specific programming idioms such as descriptors and a cleanup stack. Descriptors in Symbian are text strings. There is a library of descriptor classes incorporating all the usual string manipulation methods. Descriptors come in two main types, 8 bit and 16 bit. An 8 bit descriptor stores ASCII text or binary data, a 16 bit descriptor stores Unicode text. Together with other techniques, these keep memory usage low and memory leaks rare. There are similar techniques for conserving disk space. Furthermore, all Symbian OS programming is event-based, and the CPU is switched off when applications are not directly dealing with an event. This is achieved through a programming idiom called active objects. Correct use of these techniques helps ensure longer battery life.

3.4 Familiarization and using Symbian

After being successfully installed, the next process is to get use to and familiarize with Symbian Series 60 2nd Edition. The second, third and fourth week of the semester (FYP Part B) is allocated to get a clear understanding of the tools available in Symbian. There are four main tools provided by Symbian for developers, which are AIF Builder,

Application Wizard, CS Help Compiler and Sisar. First, Application Wizard is opened to generate a Visual C++ file of the project in the C:\Work folder. The generated file is then opened using Microsoft Visual C++ and coded in C++ language. After finished with writing the code, the user can view the output of the code by using Emulator (debug) tool which is also provided by the tool kit. The Emulator serves the function of simulating the output of the code written in the view inside the real mobile phone. Using this simulator will help in determining the effectiveness of the interface designed, correctness navigational function and also the best resolution based on different Nokia series 60 model.

The next process after being familiarized with Symbian is to develop the source code of the project, the L-Minder System using NetBeans 4.1..

3.5 Installation of NetBeans 4.1 supporting J2ME and JSR 179 (Location API for J2ME)

Next phase of project work is to install NetBeans 4.1 supporting J2ME (Micro Edition) and JSR 179, a location API for J2ME. The rest of the development process will rely on Java for interface creation of the L-Minder system and JSR 179 to link with the code developed earlier to get the Cell Id for the current location of the user in order to trigger the reminder. NetBeans 4.1 is selected because of the ease to create interfaces, screen flow and design for the L-Minder system. Compared to Symbian C++, the process of creating user interface itself can be considered as too complicated due to extensive usage of pointers inside the code and also the complex and tedious process just to compile the code to get the output. Using NetBeans, the time used to develop, compile and run the code can be reduced up to half the time used to develop system using Symbian C++.

JSR 179 on the other hand, is a location API for J2ME supported by NetBeans 4.1, designed to be compact and generic API that produces information about the present geographic location of the terminal (mobile devices) to Java application. Without this

API, J2ME would not be able to support location based applications such as the L-Minder system itself. In JSR 179, the *javax.microedition.locaton* package contains the basic classes needed to request and get a location result. The *LocationProvider* class represents a module that is able to determine the location of the terminal. This may be implemented using any possible location methods, for example satellite based method such as GPS. But in this term, the location detection method will be cellular network based method which is by using GSM network's Cell Id.

CHAPTER 4

RESULTS AND DISCUSSION

4. RESULTS AND DISCUSSION

4.1 Data Gathering and Analysis

For this chapter on Semester 1, a survey is conducted. The purpose of the survey is to get sufficient information and assessment on the existing reminder system and the plan to upgrade the reminder to be context-aware. Feedback from the respondent will help in determine level of satisfaction of the user, and also predict the outcome of access for the L-Minder system. The sample of user used is a group of 30 UTP students. All of the data obtained are then processed and analyze. The survey is available in the Appendices chapter.

4.2 Results and Discussion

Question 1 is used to detect what type of gadget that is widely used among UTP students, for example mobile phone and PDA. The primary usage of the gadget is used for communication purpose. From the 30 student sample, 26 of them uses mobile phone, 2 uses PDA and 2 uses public phone. (Refer Table 1.1 and Figure 1.7).

Gadget used	Number
Mobile Phone	26
PDA	2
Public Phone	2
Others	0

Table 1.4 Gadget used by the participants

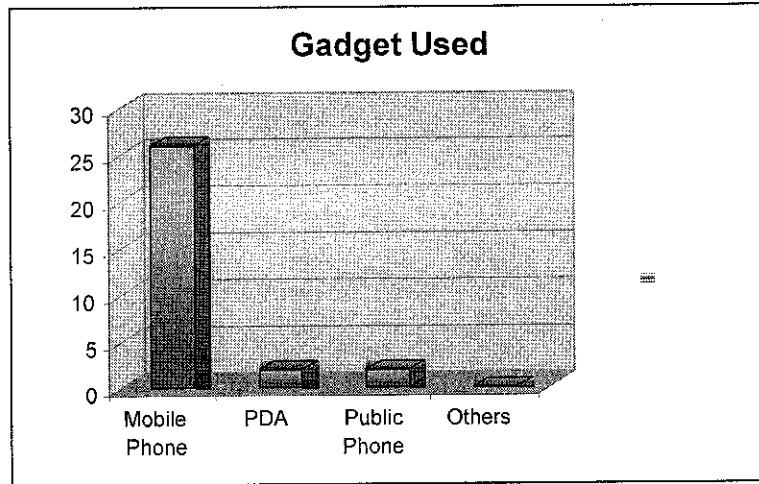

Figure 1.3 Gadget used by UTP students

Question 2 asked about the primary usage of the gadget as a reminder. In this context, for mobile phone and PDA, the reminder will be based on time and date of the event or to do list. Answers obtained shows that 93% of the respondent did use the gadget for example mobile phone and PDA as a mean to remind them, while the other 7% which is 2 persons did not.

Question 3 asked the frequency of which the gadget is used for reminder. Among the 30 respondents, 20 frequently used their gadget as a reminder, 8 seldom and 2 never used their mobile phone as reminder. The purpose of this question is to assess the frequency of usage of the gadgets as a reminder. The result is presented in the following pie chart.

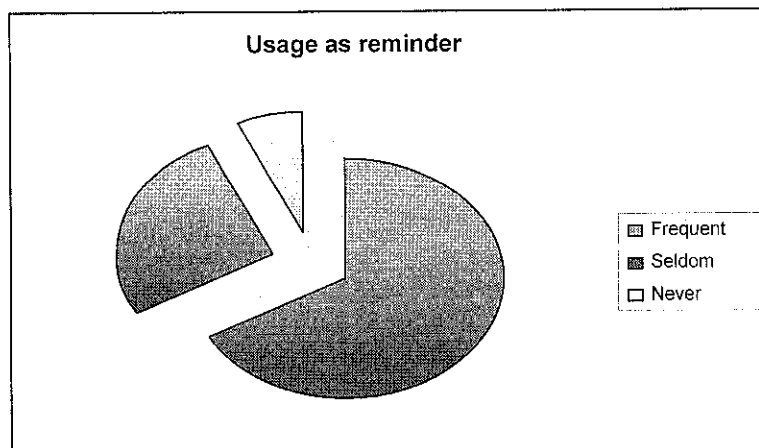

Figure 1.4 Frequency of usage

Based on the results obtained for Question 3, it shows that mobile phone and PDA usage as a method to remind is very popular among the students. The fact that may contribute to this data obtained is that mobile phone and PDA is an everyday tool, and having reminder as a basic function in these devices made it being used frequently as a reminder.

Question 4 asked about what purpose that the user normally use for their reminder. The list of task is provided in the survey and the user needs to select the usage purpose. The purpose of this question is to know what type of usage the user uses to be reminded. The survey shows that 17 students use the reminder to remind about daily task, 6 use it to remind on birthday dates, 5 use the reminder to remind about meeting time and date and 2 students use the reminder for other purpose. The result is presented in the graph below.

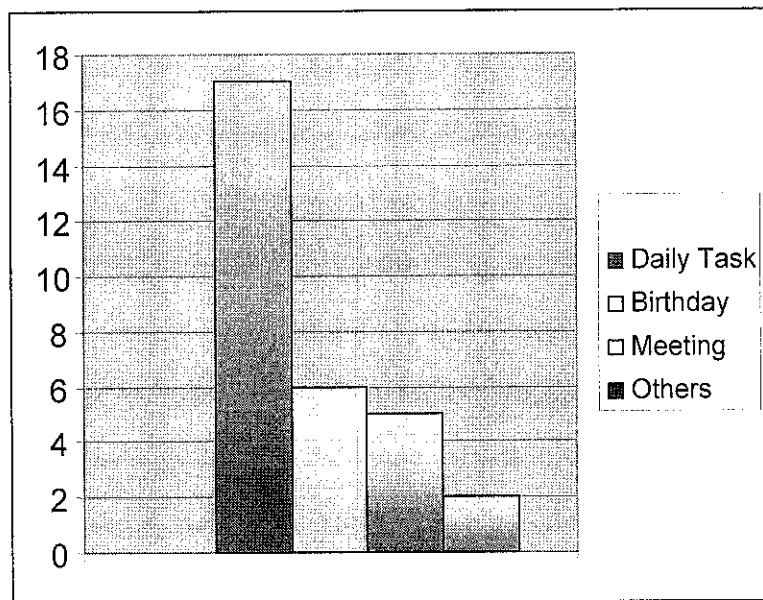

Figure 1.5 Usage Purpose

Due to the ability of the current reminder to remind based on specific time and date, and also, the availability and mobility of the device itself, whether PDA or mobile phone, made it easier for the users to use the reminder to remind about their daily task, like a to do list.

Question 5 asked did any of the student faced problem while using the existing reminder system. The answer for this question is YES or NO type of answer. The survey results show that none of the users that use the existing reminder faced any problem. The conclusion that can be made from this type of results is due to the stability of the existing reminder system. The current reminder is developed using java over mobile phone and PDA.

Question 6 and Question 7 asked about the awareness and knowledge of the respondents about the location based reminder. Only 10 of the students had known the existence of the location based reminder from their own reading. The remaining 20 students had never heard of the location based reminder before. The fact that contributed to knowledge about the location based reminder is maybe due to the habit of surfing the internet to search for materials.

Question 8 is used to detect whether the respondents would like the current time and date based reminder to be upgraded to remind also based on the user's current location. The answer for this question is YES or NO type of answer. Based on the answer obtained, from the 30 respondents, 25 of them would like an upgraded version while 5 did not. The 25 of the respondents might like to experiment on the new location based reminder and would like to try whether the added feature is useful to them or not. The remaining 5 others would like to remain with the existing reminder, and that they might feel that the reminder is fairly useful to them. The result is shown in the pie chart below.

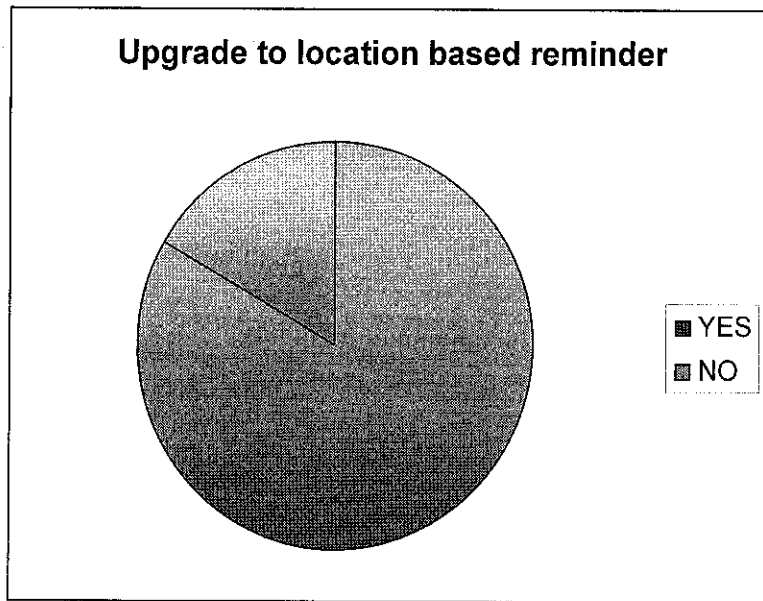

Figure 1.6 Upgrade to location based reminder

Question 9 asked about the accuracy at which the location based reminder to be. The range had been listed in the survey. The results obtained from this question shows that 19 students would like to be reminded at the exact location, 8 would like to be reminded 100-200 meters near the location, 2 would like to be reminded 300-500 meters and 1 did not care about the accuracy of the reminder. Based on this result, I have to develop a system that can remind based on the accurate location of the user. The result is shown graphically in the pie chart below.

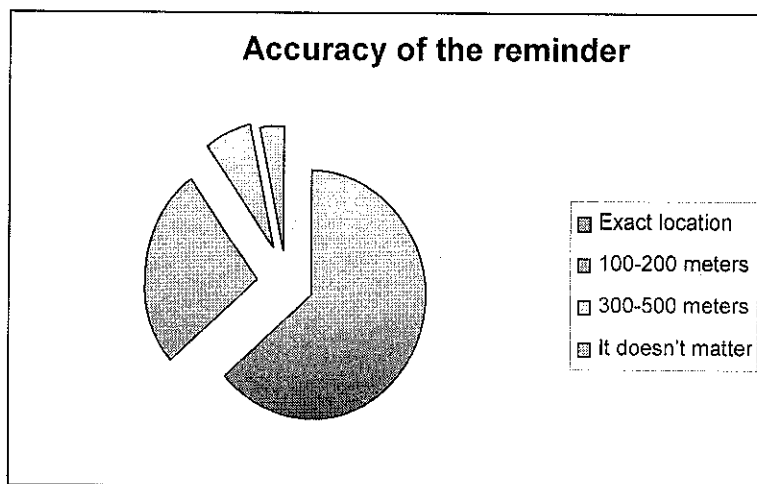

Figure 1.7 Accuracy of the reminder

Question 10 and 11, the final two questions, asked is used to assess where the user wanted to be reminded and what other upgraded features that the user would want the system to have. The results for question 10 shows that the 27 of the students or 90% of the user would want to be reminded at all places, workplace, market place and leisure locations, while 3 students or 10% of the respondents would like to reminded only at their work place. Based on this figure obtained for question 10, I can conclude that the students wanted to be reminded at all times, regardless of their location, at home, at the office, or at the market place. The final question is an open ended type of question. It asked about what other upgrades the system would like to have. Based on the feedback obtained, 20 respondents would like the system to have a voice command reminder aside from text based reminder, while 10 other would like to only have the location detection upgrade. Based on the feedback, I can conclude that the students wanted something new, and a more interactive approach to remind them which is by using voice command.

Overall, the survey carried over was a success. The 30 participants had given their full cooperation in order to complete the survey. The result may vary in way that if the number of respondents is increased, for example from 30 students to 100 students.

4.3 Selection of Global Systems for Mobile Communication (GSM) as location detection method

Last semester, research had been done in order to determine which method is the best for location detection to be used for the project. Two methods were evaluated, which are using Global Positioning System (GPS) and Global Systems for Mobile Communications (GSM).

GPS is a fully functional satellite navigation system which is a constellation of more than two dozens GPS satellite broadcasting precise timing signals by radio to GPS receiver. This enables accurate location detection (longitude, latitude and altitude) in any weather, day or night on earth. The major usage of GPS are for military

applications, navigation, surveying and location detection implemented in the comMotion system. But GPS was not chosen as a location detection method because there were several drawbacks. For example, GPS requires external device to receive GPS signal. Secondly, there is a need for the developer to translate the coordinates (latitude, longitude and altitude) to a position relevant to the user. Third is the accuracy issue, where the change of atmospheric condition, for example heavy rain or heavy snow will change the GPS signal unpredictably as they pass through ionosphere. Lastly, GPS also has the drawback of multi path issue. The radio signal reflects off surrounding terrain (i.e. building, canyon wall and hard ground). This delays the signal in reaching the receiver, causing inaccuracy.

Global System for Communication (GSM) on the other hand, however, is the most popular standard for mobile phone in the world. This standard is used by over 1.8 billion people across and territories. GSM is a cellular network, where a mobile phone that connects to it by searching for cells in the immediate vicinity. It operates in four different frequencies, but are mostly operating in 900 MHz – 1800 MHz. GSM also uses Time Division Multiple Access (TDMA) technology in the radio interface to share a single frequency between several users. See figure 1.8 below for GSM network elements

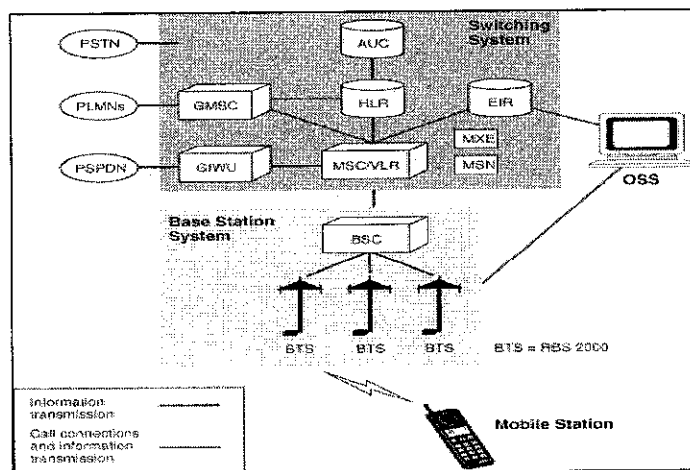

Figure 1.8: GSM network elements

In a GSM network, a Cell Id is transmitted to a mobile phone from a Base Station. It can be used to determine the location of the user as long as the user is inside the

coverage. There are four different sizes of a Cell Id, with Macro cell having the widest coverage, Micro cell, Pico cell and Umbrella cell, used to cover shadowed region of smaller cell and fill in gaps in coverage between those cells.

Using the Timing Advance principle (TA), the most accurate location of the user based on cell range coverage can be determined (refer to Figure 1.9). Timing Advance (TA), in the simplest definition, is the time delay or distance between a mobile phone and a Base Station. It is 6 bits in length and the precision is about 550 meters. It controls the precise time at which the mobile phone is allowed to transmit a burst of traffic within a timeslot (various distance of users from the Base Station). TA must also enable a mobile station moving from one cell to another to advance the timing of its transmission of digital data so that it is synchronized with the transceiver station to the new cells.

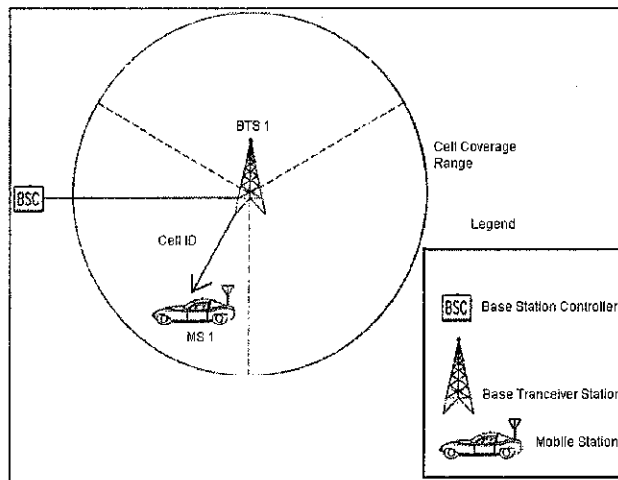

Figure 1.9: The Timing Advance (TA) Principle

Having the advantage of the availability of the Cell Id as long as the mobile phone is inside the cell coverage range, and also the implementation of the concept of Timing Advance in order to get the most accurate location of the user, GSM is chosen as the method for location detection for the L-Minder System.

4.3 Development the L-Minder System

Semester 1 of FYP, for Data Gathering and Analysis, a survey was conducted with the purpose of getting sufficient information and assessment on the existing reminder system and the plan to upgrade the reminder to be context-aware. The results of the survey involving 30 students of UTP were then presented in the form of graph, pie chart and table. Obtaining the results, Semester 2 is continued by starting the development project itself based on the numerical and statistical data obtained from survey during the first semester using Symbian C++ and NetBeans 4.1.

4.4 Location detection by getting the current Cell Id

Semester 2 focuses on development of the code for the project, the L-Minder system. The first code that needed to be developed is the code for getting or accessing the current Cell Id of the mobile phone to get the specific location of the user. Symbian Series 60 2nd Edition does not officially support access to the current GSM Cell Id, which is the core element for location detection method. But the necessary libraries are available, and the older version of Symbian for Communicator 9200 SDK contains the necessary .h files.

To develop the code for getting the current Cell Id, Symbian for Communicator 9200 SDK, which is a tool kit for Communicator phone, is first downloaded from the Internet. The necessary .h files, the etel.h file and the etelbgsm.h file is then copied to the C:\Symbian\6.1\Series60\Epoc32\include directory. Both files are then linked with the application after compilation. Since the code is requires an input that can only be obtained by accessing a GSM network, which is the Cell Id, the code can only be compiled to check for syntax errors using Symbian Series 60 SDK 2nd Edition, but it could not run on the Emulator (to show the output of the code). It can only run on a real mobile phone. The code had been tested by transferring it into a Nokia Series 60 mobile phone, the Nokia 7610 and executed successfully by getting the current Cell Id of the mobile phone. The code can be viewed in the Appendices chapter.

Developing the project itself is a learning process as the author can be considered as fairly new in developing applications for mobile devices using Symbian and NetBeans 4.1.

4.5 Triggering the alarm based on Cell Id matched from reminder

To use the reminder, the user will have to first assign the locations to each icon provided in the interface. The interface design is as much as possible made simple to provide ease of use and easy navigation for the users. To suite the daily life preference of the users, icons provided and labeled as places where users normally are, which are Shopping, Market and Office. To assign location to these icons, the users need to press (mobile phone view) or click (emulator view) on the Options button and key in the name of the location based on the icons provided, for example, the Market icon assigned to the location of Tronoh.

Next, after the location is assigned, the users then need to create the reminder for the particular location, for example, when I arrive at Tronoh, buy lemonade. The users can drive or walk to Tronoh to perform other chores for example, and upon reaching Tronoh, the alarm will trigger and display the text message of the reminder being set earlier. The overall process is described in the Figure 1.3 below.

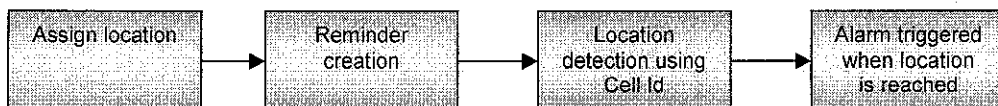

Figure 2.0: Flow chart of the system

The triggering of the alarm is resulted by linking the code for getting the current Cell Id of the user from the mobile phone. The act of the user assigning location to the icons provided in the system is the actually the act of assigning a Cell Id associated with the reminder. Cell Id changes from one location to another depending on the nearest Base Transceiver Station located to the user. When the user is within the Base Transceiver Station (BTS) that submits the Cell Id that matches the one that is assigned earlier, the alarm function of the reminder will trigger. The problem that arises is that the frequent change of cells if the user is not static in one particular location. This problem is solved using the basic algorithm that follows the condition that the Cell Id of the user is determined by the longest time the user is located within the nearest Base Transceiver Station (BTS). The overall screen shot of the system can be viewed in the Appendices chapter.

4.2.4 Accuracy issue of using GSM Cell Id

In terms of location detection, usage of GSM Cell Id manages to detect the current location of the user. L-Minder managed to utilize the concept of Timing Advance as described in Figure 2.0 below.

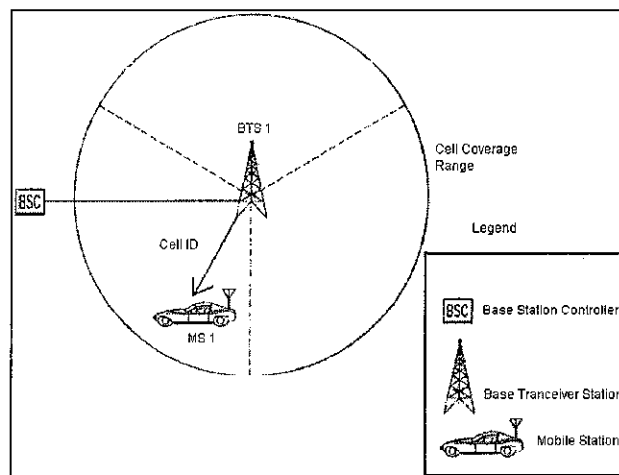

Figure 2.1: Timing Advance Principle

Let's assume that the user is the Mobile Station 1 (MS 1). As the user enters the cell coverage range covered by the Tronoh Base Transceiver Station (BTS 1), the BTS will check with Base Station Controller (BSC) on whether the user is allowed to be assigned the Cell Id of Tronoh. Once the BSC acknowledges that the BTS 1 is the nearest BTS to the user, by using the Timing Advance Principle, mobile station Cell Id is now set to be Tronoh. Timing Advance Principle (TA) is defined as the time delay or distance between the mobile station and the Base Transceiver Station (BTS). TA controls the precise time at which the phone is allowed to transmit a burst of traffic within a time slot. It must enable the MS 1 to move from one BTS to another to advance the timing of its transmission of digital data so that it is synchronized with the BTS of the new cell (kindly refer to Figure 2.1: Mobile Station transition from one BTS to another).

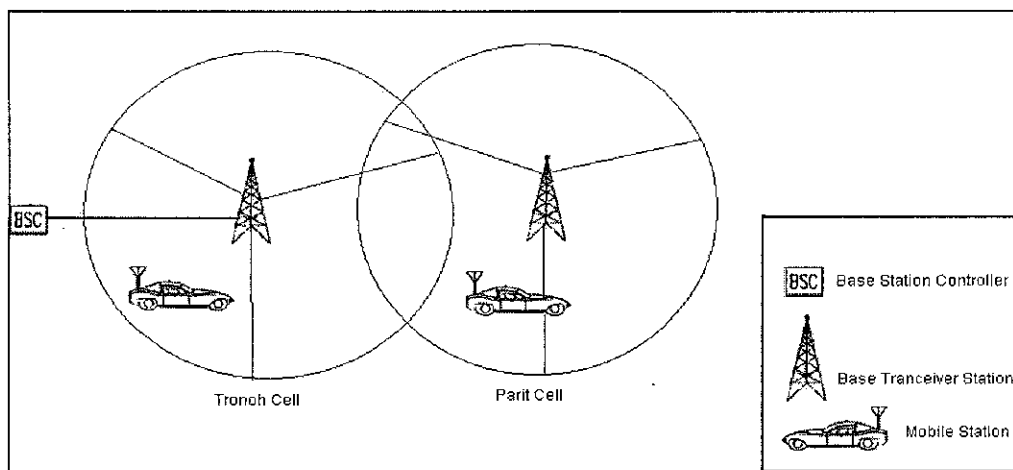

Figure 2.2: Mobile Station transition from one BTS to another

But the system can not fulfill the requirements in terms of specific accuracy, meaning that the system can detect where exactly the user is at a particular time. Taking the example from the scenario above, where the alarm triggers when the user reaches Tronoh. If the user set the reminder to trigger when he reaches a village in Tronoh, let say Kampong Pauh, the alarm would not function, because the location detected by the mobile phone is Tronoh, not Kampong Pauh. To achieve the most accurate location detection, the Advanced Timing Advance (ATA) Method must be used. The ATA method is described by the figure below.

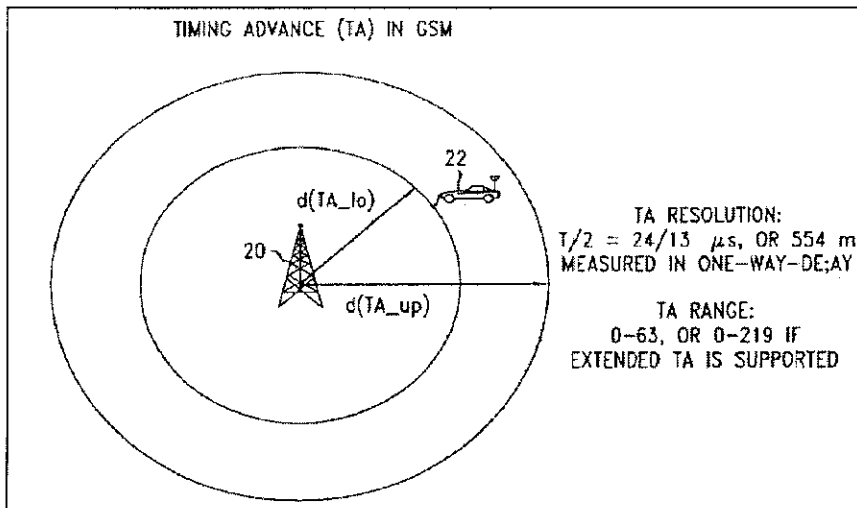

Figure 2.3: Advanced Timing Advance Method

The ATA method establishes two Timing Advance layers, namely TA_lo for lower or inner Timing Advance and TA_up for upper or outer Timing Advance. How to detect the specific location of where the user is in a cell coverage is explained in the figure below:

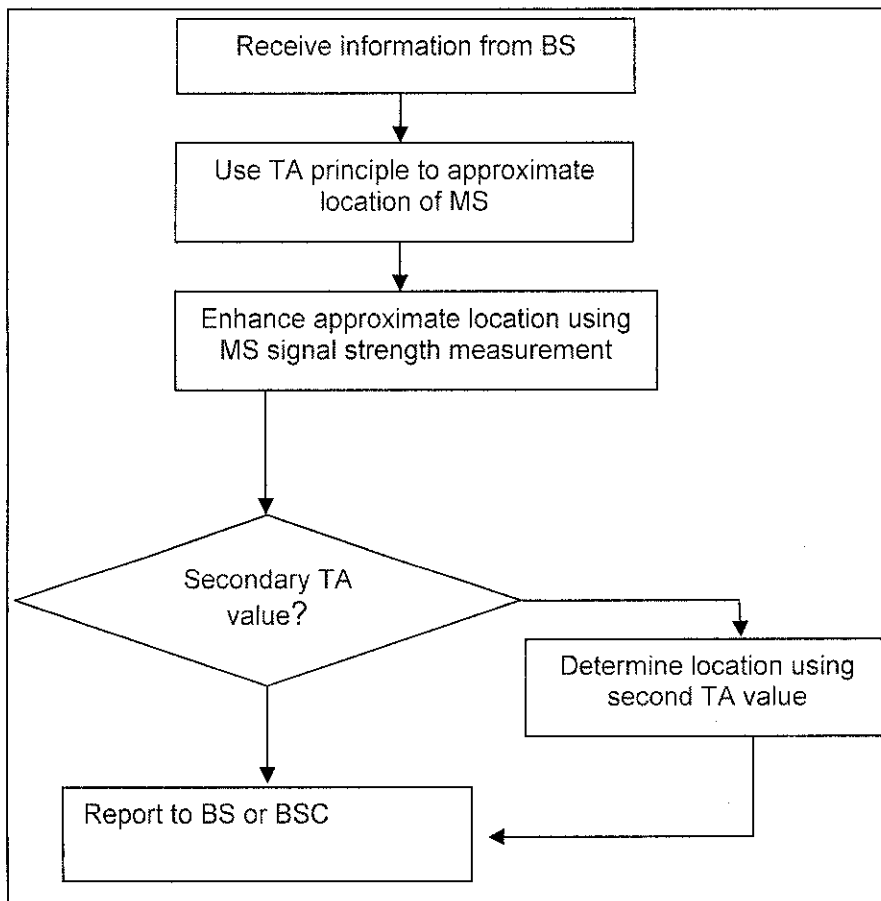

Figure 2.4: Accurate location detection using Advanced Timing Advance principle

CHAPTER 5

CONCLUSION

5. CONCLUSION

The L-Minder System had been able to achieve and fulfill the requirement of being able to detect the location of the user and remind the users of the task needed to be done based on their location. Extensive research had been done shows that user's preferences over Location Based Reminder's features change from time to time. For example, having an artificial intelligence feature would much help users in reminding themselves, where they are and when they were supposed to perform the task.

Even if the existing location based reminder system had fulfilled the requirement of being able to remind, but they still lack those of accuracy, perfect location detection and maintainability of the location acquired. During research phase on Semester 1 of FYP Part A, the author managed to research on a better way of determining the most accurate location using Cell Id which was by using Advanced Timing Advance Method, but unfortunately due to complexity of implementation and time constrain, the method was not used for the L-Minder.

In the future, the author hoped that the L-Minder system can be improved by having to remind the users exactly where they are by using Advanced Timing Advance Method as mentioned above, and also expand the functionality of this location based reminder, for example by assisting users who lost their way to certain places to navigate their way to places that they want to go after being able to accurately detect their location. Last but not least, is highly hoped that the completion of the L-Minder system is not the end of research and development for location based services namely location based reminders.

REFERENCES

Literature

1. Fox, Dan & Box, Jon (2004). Building Solutions with the Microsoft .NET Compact Framework: Architecture and Best Practices for Mobile Development. Boston: Addison-Wesley.
2. Elliot, Geoffrey & Philips, Nigel (2003). Mobile Commerce and Wireless Computing Systems. England: Pearson Education.

Internet

- [1] Mark Weiser, October (1993) "Hot Topics: Ubiquitous Computing"
<http://www.ubiq.com/hypertext/weiser/UbiHome.html>
- [2] Paul Dourish, (2001) "Introduction to special issue on Context-Aware Computing"
<http://hci-journal.com/editorial/si-context-aware-intro.pdf>
- [3] <http://www.gsmworld.com/index..shtml>
- [4] Natalia Marmasse, "comMotion: a context aware communication system"
http://alumni.media.mit.edu/~nmarmas/cm_chi99.pdf
- [5] Active Campus
<http://activecampus.ucsd.edu/>
- [6] Timothy Sohn, Kevin Ai Li, Gunny Lee, Ian Smith, James Scott and William G.Grisworld "Place-Its: A Study of Location Based Reminders on Mobile Phones"
<http://www.cambridge.intel-research.net/~jscott/pubfiles/ubicomp2005-placeits.pdf>
- [7] Pamela J.Ludford, Dan Frankowski, Ken Reily, Kurt Wilms, Loren Tarveen
"Because I Carry My Cell Phone Anyway: Functional Location Based Reminder Applications"
<http://delivery.acm.org/>
- [8] Anid K.Dey and Gregory D.Abowd "CyberMinder: A Context-Aware System for Supporting Reminders"
<http://www-static.cc.gatech.edu/fce/contexttoolkit/pubs/HUC2000.pdf>

APPENDICES

Source code for getting the current Cell Id

// Code by: Muhammad Fitri Bin Husin

// Date: 6 July 2006

// Project Title: L-Minder System

// Purpose: Access the current Cell Id information

```
RBasicGsmPhone phone;
```

```
RTelServer server;
```

```
User::LeaveIfError( server.Connect() );
```

```
// load a phone profile
```

```
_LIT(KGsmModuleName, "phonetsy.tsy");
```

```
User::LeaveIfError( server.LoadPhoneModule( KGsmModuleName ) );
```

```
// initialize the phone object
```

```
RTelServer::TPhoneInfo info;
```

```
User::LeaveIfError( server.GetPhoneInfo( 0, info ) );
```

```
User::LeaveIfError( phone.Open( server, info.iName ) );
```

```
MBasicGsmPhoneNetwork::TCurrentNetworkInfo ni;
```

```
User::LeaveIfError( phone.GetCurrentNetworkInfo( ni ) );
```

Screen Shot of the L-Minder System

Main Screen

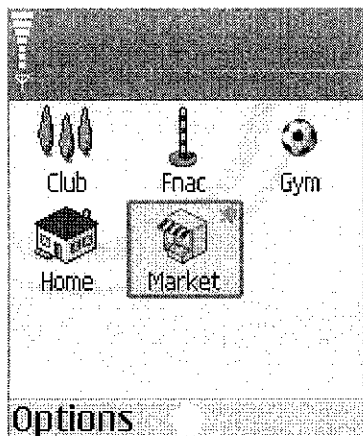

Edit location

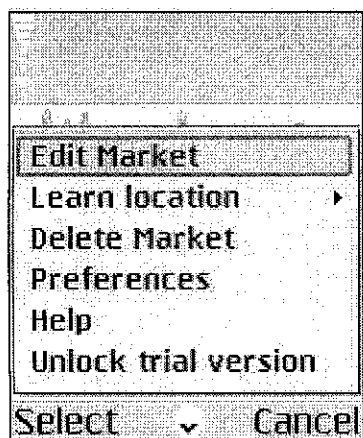

Voice Note

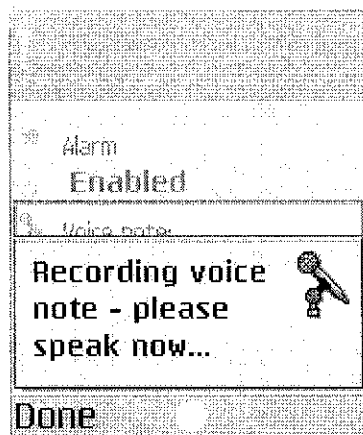

Create Reminder

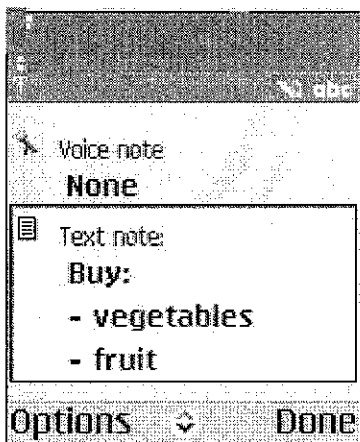

Alarm Triggered



Survey Form for L-Minder System

FINAL YEAR PROJECT

Project's Title: Location Based Reminder System

Please answer the questions by circling the desired answer.
Your feedback will help in developing the Location Based Reminder System.

1. Which gadget/method do you use for communication (i.e. call, text message)?

- Mobile Phone
- PDA
- Public Phone
- Others

2. Does the gadget have a reminder function?

- Yes
- No

3. If yes, how often do you use the gadget's function as a reminder?

- Frequently
- Seldom
- Never

4. What do you normally use the reminder to remind you about?

- Daily task to be completed
- Birthdays
- Meetings
- Others _____

5. Do you face any problem using while using it as a reminder? (If yes please state the problem that you faced)

- Yes _____
- No _____

6. Have you ever heard of Location Based Reminder?

- Yes
- No

7. From whom do you hear about the Location Based Reminder?

- From reading
- From a friend
- From the lecturer

8. Would you like the reminder to have an upgraded feature of reminding based on your location?

- Yes
- No

9. How accurate would you want the location detection to be?

- At the exact location
- 100-200 meters near the location
- 300-500 meters from the location
- It doesn't matter

10. What place would you like the reminder to remind you?

- Work and learning place (example: School, Office, Home, Training Center)
- Market place (example: markets, shopping malls)
- Leisure place (example: resorts, hotels, beauty spa)
- All of the above

11. What other upgraded features that you would like the reminder to have aside from Location Detection? Please state

Thank you for your cooperation. ☺