

**Problem Report Management System of IT Department,
Ministry of Information –
Research in Workflow Concept.**

by

Mohd Faizul B Mohd Faudzi

Dissertation submitted in partial fulfillment of
the requirements for the
Bachelor of Technology (Hons)
(Information System)

JUN 2004

University Teknologi PETRONAS
Bandar Seri Iskandar
31750 Tronoh
Perak Darul Ridzuan.

t
HD
30.2
M697
2004

1. Knowledge management
2. IT/IS -- Thesis.

CERTIFICATION OF APPROVAL

**Problem Report Management System of IT Department,
Ministry of Information –
Research in Workflow Concept.**

by

Mohd Faizul B Mohd Faudzi

A project dissertation submitted to the
Information System Programme
Universiti Teknologi PETRONAS
in partial fulfillment of the requirement for the
BACHELOR OF TECHNOLOGY (Hons)
(INFORMATION SYSTEM)

Approved by,

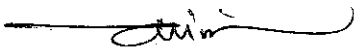

(Puan Aliza Bt Sarlan)

UNIVERSITI TEKNOLOGI PETRONAS
TRONOH, PERAK
Jun 2004



UNIVERSITI
TEKNOLOGI
PETRONAS

Certification of FYP Final Draft Submission

Herewith I, Mohd Faizul B Mohd Faudzi, student's ID 1830, certify that I am responsible for the work submitted in this project, and I have done all the modifications according to my supervisor's advice.

Thank you.

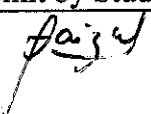
	Submit by Student	Verify by Supervisor
Signature		
Name	Mohd Faizul B. Mohd Faudzi	
Student ID	1830	
Date	16/6/2004	

ACKNOWLEDGMENT

First of all I wish to offer my greatest appreciation to my God because of His help and kindness, I successfully completed this research.

A deepest appreciation for my beloved supervisor, Puan Aliza Bt Sarlan, who provided inspiration and ideas throughout the completion of this project. Many of the ideas in this project are the result of brainstorming and discussing sessions with her.

Special thanks also go to Mr Asri B Ismail, the director of IT Department, Ministry of Information, who has given me commitment and support in accomplishing this research, as well as his staffs who helped me in researching the subject matter.

Sincere thanks go to my friends who helped me in testing the prototype and gave the feedback in return to enhance my prototype. Finally, I give my special thank to Universiti Teknologi Petronas who gave me an opportunity in improving myself upon completing this project.

ABSTRACT

This project is aimed to study on current problem of problem reporting process in Ministry of Information and to propose a new system that will automate the current system. As a mean to keep this procedure or flow of works unchanged or suitable with the current condition, the study on workflow process is very important.

The scope of reasearch will focus on current workflow and define the problems and diffilculties resulted from it. Then a new workflow will be designed to be a new Problem Report Management System (PRMS) that uses helpdesk system as a tool.

The project starts with research and analysis and finally a working prototype will be developed to simulate the proposed system. The research will cover the aspect of workflow management of current system. Then the analysis will be focused on developing a new system that uses the new wrokflow that expectedly will save the time and more structured. This includes how the Knowledge Management System (KMS) and Short Messaging System (SMS) will smooth the flow of work and become more effective.

TABLE OF CONTENTS

CHAPTER 1 : INTRODUCTION	1
1.1 Background of Study	1
1.2 Problem Statement	1
1.3 Objectives	2
1.4 Scope of Study	2
CHAPTER 2 : LITERATURE REVIEWS	3
2.1 Workflow and Workflow Management	3
2.1.1 Key Benefits of Workflow Management	4
2.2 What is knowledge management?	5
2.2.1 Data, information and knowledge	6
2.3 Helpdesk as an Application of Knowledge Management	7
2.2.1 Helpdesk System Features	8
CHAPTER 3 : METHODOLOGY / PROJECT WORK	9
3.1 Preliminary Study	9
3.2 Detailed Analysis	9
3.3 Result and Evaluation	10
CHAPTER 4 : RESULTS AND DISCUSSION	11
4.1 Findings	11
4.1.1 Change to Computerized Way	14
4.2 System Design	14
4.2.1 System Framework	14
4.2.2 System Functionality	15
4.2.3 System Workflow	17
4.2.4 System Interaction	21
4.3 The Prototype	23
4.3.1 Data Flow	23
4.3.2 System Interface	26

4.3.2	System Requirement	32
4.4	Discussion	33
4.4.1	Advantages	33
4.4.2	Limitations	34
4.4.3	Knowledge Management as Organizational Learning and Decision Support Services.	35
CHAPTER 5 : CONCLUSION AND RECOMMENDATION		37
5.1	Conclusion	37
5.2	Recommendation	37
REFERENCES		38
APPENDICES		39

LIST OF FIGURES

Figure 4.1 Current workflow process of problem reporting in Ministry of Information	12
Figure 4.2 Proposed system framework	15
Figure 4.3 Use case diagram of helpdesk system.	17
Figure 4.4 New workflow using helpdesk system	18
Figure 4.4.1 Detail workflow on using knowledge base.	19
Figure 4.4.2 Detail workflow on reporting a problem.	20
Figure 4.5.1 Activity diagram for problem solving based on knowledge.	21
Figure 4.5.2 Activity diagram for problem solving based on problem reporting.	22
Figure 4.6 Context-level DFD for proposed system.	23
Figure 4.7 Diagram 0 of the proposed system.	24
Figure 4.8 Interface design for report submission	26
Figure 4.9 Interface design for report search	27
Figure 4.10 Interface design for report details	28
Figure 4.11 Interface design for knowledge search	29
Figure 4.12 Interface design for knowledge details	29
Figure 4.13 Interface design for report search	30
Figure 4.14 Interface design for report management	30
Figure 4.15 Interface design for vendor search	31
Figure 4.16 Interface design report statistic.	31
Figure 4.17 Interaction of data, information and knowledge.	36

LIST OF TABLES

Table 2.1 Definitions of data, information, and knowledge

7

ABBREVIATIONS AND NOMENCLATURES

HQ – Headquarter of Ministry of Information

PRMS – Problem Reporting Management System

WF– Workflow

WFM – Workflow Management

KM – Knowledge Management

SDLC - System Development Life Cycle

UML- Unified Modeling Language

DFD – Data flow diagram

SMS – Short Messaging System

CHAPTER 1

INTRODUCTION

1.1 BACKGROUND OF STUDY

Currently problem reporting process of Ministry of Information has been done manually. This is because they have no computerized system as their IT department was just newly set up. The staffs only make phone call to make the problem report and the reports only recorded on documents that are temporarily stored until the problem settled down. The unavailability of data record management makes the system ineffective and waste time.

1.2 PROBLEM STATEMENT

From the research, the author found out that there is no consistent procedure or standard in order to make a report. The workflow is easily changed according to situation. As an example, a branch staff can make a report directly to headquarter (HQ) or they can make it through state department. Both ways can result on same result but it is worse when there is no mechanism to check out what is current status of a report, whether it is being opened, analyzed or closed. This is a result from unavailability of database that is instead will keep record of all reports made.

When there is no indicator of what is current status for a report, the maintenance becomes very hard especially when HQ wanted to schedule the maintenance. Sometimes, HQ didn't even know the problem until they go to the location themselves. The problem became worst when the person sent to the location cannot fix the problem due to improper understanding of the problem. This situation absolutely delayed the problem solving.

What they need is actually a system that uses a standardized way of problem reporting. For the best result they can use computerized system that speed up the process and result in more effective system.

The unavailability of database gives them no historical information to make decision. Currently, the HQ only take action with regard to the problem reported. There is no process to check how many times the staff has made the report, how many time the same problem reported, how many reports has been made in each branch and many more aspects. These aspects are very important especially when the HQ plan to decide action for each problem. For example, may be the same problem has been reported by the same staff, so the HQ can prepare earlier to solve the problem.

1.3 OBJECTIVES

- To understand and investigate current process workflow of manual problem reporting of IT department Ministry of Information
- To propose new Problem Report Management System (PRMS) based on new workflow
- To develop a prototype to implement the new PRMS.

1.4 SCOPE OF STUDY

The study will cover on these areas:-

1.4.1 Research on workflow

- To research current workflow of problem reporting process.
- To develop new conceptual framework of a new workflow for PRMS.

1.4.2 Prototype development

- To develop a working prototype of new system based on new workflow.

CHAPTER 2

LITERATURE REVIEW

2.1 WORKFLOW (WF) AND WORKFLOW MANAGEMENT (WFM)

According to Howard Smith (2003)

The word “workflow” is etched into our collective consciousness ... the *flow* of *work*. We each have a deep-seated understanding of what this means based on our experience at work and our work with existing workflow technologies. In our respective organizations we spend a lot of time with documents and forms. We pass documents and forms to each other in support of our daily tasks. We do this in a myriad ad-hoc patterns using electronic mail and in more prescriptive ways using workflow management systems. Workflow systems structure our document exchanges so that our work has rigor. We are enslaved by workflow and simultaneously empowered by it. Such systems let us set out the desirable flows of work and our computers help us with tasks that can be so automated, freeing us for more creative and productive activities.

(p. 1)

According to Intecs Sistemi Group, a WF is composed of multiple tasks (also called steps or activities). We distinguish two types of tasks: simple tasks which represent individual indivisible activities, and compound tasks which represent some activities which can be divided into sub-activities (both simple tasks and even other compound tasks). An entire workflow can be regarded as a large compound task. A simple task may be a program which can run on processing entities, which include application systems, servers supported by client-server systems or Transaction Processing Monitors, Data Base Management Systems, etc. Tasks are operations or a sequence of operations that are submitted for execution at the processing entities using their interfaces. In addition to a collection of tasks, a workflow defines the order of task invocation or conditions under which tasks must be invoked, task synchronization, and information flow (dataflow).

WFM is a technology supporting the reengineering (including automating) of business and information processes. It involves:

1. defining workflows, i.e. describing those aspects of process that are relevant to control and coordinate the execution of its tasks (and possibly the skills of individuals or information systems required to perform each task), and
2. providing for fast (re)design and (re)implementation of the processes as business needs and information systems change.

Hence, WFM involves everything from modeling processes up to synchronizing the activities of information systems and humans that perform the processes. As consequence, the first issue is to model the process. Since capturing a process means understanding it, this usually involves interviewing people with expert knowledge about the process. Interview methodologies such as those used for expert (or knowledge-based) systems design are appropriate for conducting such interviews. When enough knowledge about the process is obtained, workflow specification is performed to capture the process.

Performing workflow specification requires a workflow model, which typically includes a set of concepts useful to describe processes, their tasks, the dependencies among tasks, and the required roles that can perform the specified task. Workflow specification is usually performed using workflow specification languages, which use rules, constraints, and/or graphical constructs to describe the ordering and synchronization of tasks in a workflow, and task attributes to describe the tasks and the roles to perform them.

2.1.1 Key Benefits of Workflow Management

According to Diogo Teixeira and Jeff Thompson (1993)

The discussion on workflow benefits from numerous references to how workflow is being applied in collection systems, mail tracking systems and credit card processing, among others.

Five benefits are given for adopting workflow software:

1. There is faster processing of work, since the total transaction time is generally much greater than the time to complete the work steps
2. Workflow systems are usually based on the client-server architecture, as opposed to mainframes
3. The information processes of the bank (the "work flows") are made explicit and are more easily changed
4. Paper is eliminated
5. Financial losses from misprocessed paper are eliminated

W. Edwards Deming's "Theory of Knowledge" (1995) stated that management of a system should focus on managing the present and the future. Without workflow, organizations are occupied tracking the status of work efforts that have taken place. In other words they "*still manage based on the results of the last periods work. Little or no attempt is made to actively manage tomorrow.*"

2.2 WHAT IS KNOWLEDGE MANAGEMENT?

Knowledge Management (KM), also referred to as corporate memory, is an emerging discipline that comprises activities focused on a formalized, integrated approach to managing an enterprise's tangible and intangible information assets, or enterprise knowledge. Organizations have just recently started to consider the strategic value of their intellectual assets. These assets, which include knowledge experience and expertise, are a highly volatile component of the enterprise's intangible assets.

KM can be viewed as a systematic learning process, which provides increased flexibility by focusing on an organization's need for knowledge. KM includes issues related to developing, implementing and maintaining the appropriate technical and organizational infrastructures, which enable enterprise knowledge sharing and the selection of specific contributing technologies and vendors to leverage knowledge across the corporation.

Based on the common key aspects of flexibility, integration, and adaptively and on the three primary areas of KM (acquisition, representation and reuse), a strong correlation exists between KM and Knowledge Engineering (KE). However, there are differences in their scope and objectives.

KM defines the strategic objectives and long-term knowledge integration direction. It also encompasses the analysis and modeling of an enterprise and its future evolution based on corporate strategic objectives. KE designs effective implementation framework and technologies to meet the enterprise's knowledge management needs and supports the integration of models of expertise from different groups in an organization into a coherent corporate expertise model.

2.2.1 Data, Information and Knowledge

According to Russell Ackoff, a systems theorist and professor of organizational change, the content of the human mind can be classified into five categories:

1. **Data:** symbols
2. **Information:** data that are processed to be useful; provides answers to "who", "what", "where", and "when" questions
3. **Knowledge:** application of data and information; answers "how" questions

A further elaboration of Ackoff's definitions follows:

Data - data is raw. It simply exists and has no significance beyond its existence (in and of itself). It can exist in any form, usable or not. It does not have meaning of itself. In computer parlance, a spreadsheet generally starts out by holding data.

Information - information is data that has been given meaning by way of relational connection. This "meaning" can be useful, but does not have to be. In computer parlance, a relational database makes for information from the data stored within it.

Knowledge - knowledge is the appropriate collection of information, such that it's intent is to be useful. Knowledge is a deterministic process. When someone "memorizes" information (as less-aspiring test-bound students often do), then they have amassed knowledge. This knowledge has useful meaning to them, but it does not provide for, in and of itself, an integration such as would infer further knowledge. For example, elementary school children memorize, or amass knowledge of, the "times table". They can tell you that "2 x 2 = 4" because they have amassed that knowledge (it being included in the times table). But when asked what is "1267 x 300", they can not respond correctly because that entry is not in their times table. To correctly answer such a question requires a true cognitive and analytical ability that is only encompassed in the next level... understanding. In computer parlance, most of the applications we use (modeling, simulation, etc.) exercise some type of stored knowledge.

Table 2.1 states various meanings of data, information and knowledge.

Author(s)	Data	Information	Knowledge
Wiig [41]	-	Facts organised to describe a situation or condition	Truths and beliefs, perspectives and concepts, judgements and expectations, methodologies and know-how
Nonaka and Takeuchi [23]	-	A flow of meaningful messages	Commitments and beliefs created from these messages
Spok and Spijkervet [32]	Not yet interpreted symbols	Data with meaning	The ability to using meaning
Davenport [15]	Simple observations	Data with relevance and purpose	Valuable information from the human mind
Davenport and Prusak [16]	A set of discrete facts	A message meant to change the receiver's perception	Experiences, values, insights, and contextual information
Quigley and Debons [28]	Text that does not answer questions to a particular problem	Text that answers the questions who, when, what, or where	Text that answers the questions why and how
Cheeo <i>et al.</i> [12]	Facts and messages	Data vested with meaning	Justified, true beliefs

Table 2.1 Definitions of data, information, and knowledge

2.3 HELPDESK AS AN APPLICATION OF KNOWLEDGE MANAGEMENT

Help desk is a term used to describe a source of technical support for hardware or software. Help desks are staffed by people that can either solve the problem directly or forward the problem to someone else. Help desk software provides the means to log in problems and track them until solved. It also provides the management

information regarding support activities. In real life, help desk becomes more important and serves as Problem Report Management System (PRMS). Problem report management systems (PRMS) are also known as "bug-tracking systems", though the entries need not be bugs (e.g., think of change requests).

According to GNAT Group (2003)

PRMS is aimed to store all information about the problem reports at a central site, and enables users to access this site by various means, including e-mail, WWW, and a network daemon. New problem reports can be created, and existing reports can be queried and updated, by most of these means.

PRMS is widely customizable: Of course we can define report categories (is the report about tool A or service B?), responsables (who takes care of this report?), and submitters (is it from staff?). We can also define possible states of a report (open, analyzed, closed, etc.) and classes (software bug, documentation bug, change request, ...).

2.3.1 Helpdesk System Features

Konica Business Technologies (2002) states that helpdesk system enables fully automatic tracking of all internal and external issues by defining a workflow through which issues are moved from inception to resolution and closure. All customers' issues are worked with and tracked from within a web browser-enabled user interface using open architecture, making the system easy to learn and easy to use. The system can be tailored to meet the unique needs of particular business.

They point out six features of helpdesk system:-

- Open architecture.
- Workflow automation.
- Web browser-based interface.
- Email notification.
- Reporting and knowledge base.
- Easy to use and setup.

CHAPTER 3

METHODOLOGY / PROJECT WORK

Basically the author applies basic System Development Life Cycle (SDLC) to complete this project. It includes Planning, Analysis, Design and Implementation. To summarize it, below is step by step procedure used to complete the research as well as prototype in given period of time.

3.1 PRELIMINARY STUDY

This is the phase to clearly define problem, objective and scope of the study. Research on subject matter is done here. The author at this time should know what are workflow concept as well as clear understanding on workflow of helpdesk system.

Research done by gathering all information about workflow and current helpdesk system practiced from related books, website, previous research done, people and many more. To get clear understanding on subject matter, all information were classified according to its topic; workflow, helpdesk and knowledge base. The important thing to be considered here is to study on previous research done and this project is aimed to enhance previous it.

3.2 DETAILED ANALYSIS

This phase is where information gathering starts. The author will collect all data and information about the current system of problem reporting of IT department Ministry of Information. Also the author will research more detail in workflow concept and study on available workflow-based system applied by most organization.

In this phase, the author should know the flow of process of current system, the problem encountered, advantages and disadvantages, procedure related and etc. At

the end of the phase, the author should analyze and design the new workflow that will overcome the current problem and state clearly the advantages and disadvantages as well as how to apply the new system.

3.3 RESULT AND EVALUATION

In this phase, the author will complete the documentation of the research and prepare the final dissertation as a result. For the best result, the author will develop a working prototype of new system based on new workflow to demonstrate the new system.

The prototype is completed within development phase in about 2 months. The prototype is designed to illustrate working system that is expected to suit working environment on bureaucratic organization (government).

Evaluation is done to evaluate whether the research and prototype has met the objectives. The testing was done with Director of Ministry of Information and selected people. The result then output the benefits that they found in this new system. From the feedback, future improvement recommended to enhance research in this area.

CHAPTER 4

RESULTS AND DISCUSSION

The focus of this project is to study and understand on current workflow of problem reporting in IT department on Ministry of Information. The aim of this project is to develop new conceptual framework of a new workflow for a new system called Problem Report Management System (PRMS).

The main idea for improving this situation is by developing a helpdesk system that is aimed to automate this system. Throughout this section, Unified Modeling Language (UML) will be used as modeling technique. It consists of use case diagram and sequence diagram. Other than that, flow chart, ERD diagram and DFD diagram also being used to give clear picture of technical design aspect of the system.

4.1 FINDINGS

After interview session with Director of IT department, the author found out that there are many problems on the current problem reporting process due to manual process practiced. Figure 4.1 shows the workflow of current problem reporting process.

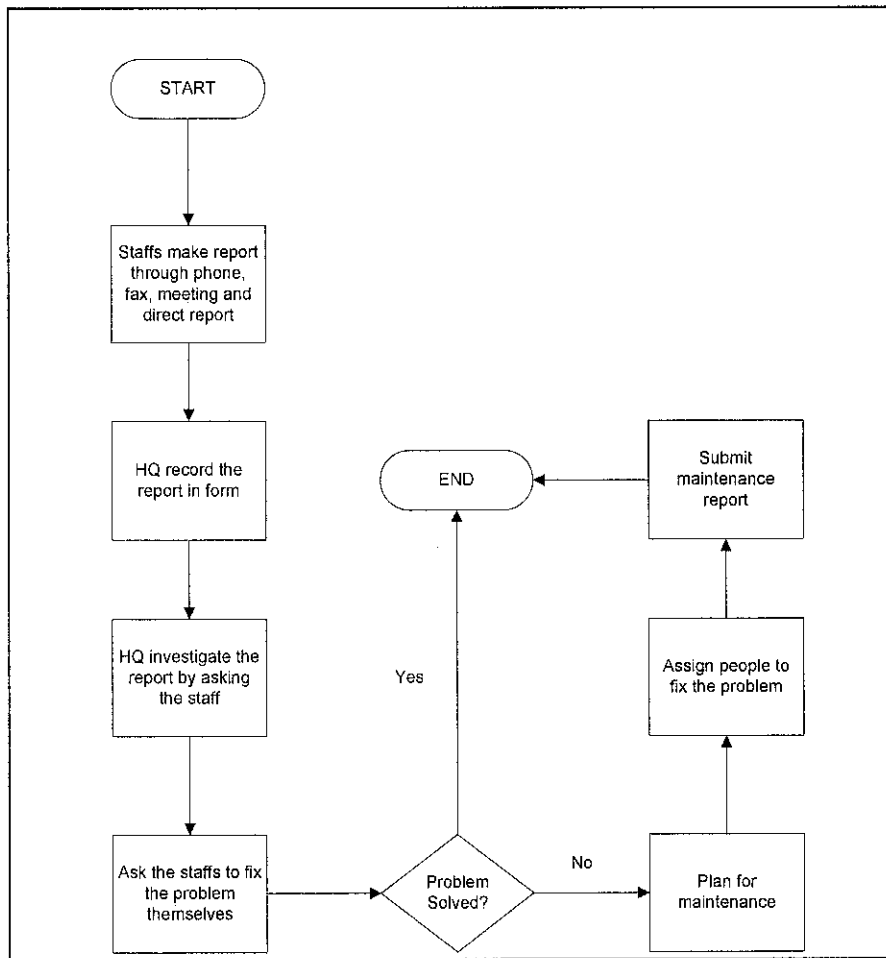

Figure 4.1 Current Workflow Process of Problem Reporting in Ministry of Information

The process starts when a staff makes report to the HQ whether by phone, fax, in meeting or reports it directly about the problem he/she faces on their computers. Formally all reports must be done in a report form that is later will be submitted to HQ. However to cut the time especially when the place where the report is being made is very far away from HQ, they only need to make phone call and then HQ will record the report in the same form. They can also fax it directly to HQ or tell their problem when they held a meeting or even when they meet accidentally with the staff who responsible in keeping the report.

As we can see there is no standard procedure in order to make a report. After that, HQ will start investigate each report by asking the staff who has made the report. This is done by asking them directly through phone or face to face.

After identifying what the problem is, the HQ will ask the related staffs to solve the problem themselves. If they can fix it, the problem is perceived as solved and the process is going to end. If the staff cannot solve it themselves, then the HQ will plan for maintenance and assigned people to fix it. Lastly the person or vendor who is responsible in solving the problem must document the step they use to fix the problem.

According to the Director of IT department, there are six main problems in this manual procedure:-

1. There is no database to record the report. Currently they use a form to record the report and the form will be unused as the problem solved.
2. There is no mechanism to check the status of each report whether it is being opened, analyzed and closed.
3. Many time wasted in classifying the report. This is further infection of previous problem. When there are no database to record the reports and no status on each report, they manage all reports in very hard way. Sometimes they process same report again and this completely wastes the time.
4. Action taken to fix the problem is late due to much time wasted in classifying the report. Because of this the particular staffs cannot do their job when they need to use their computers.
5. There is no systematic procedure in reporting a problem. This is the weakest part in current process of problem reporting. Sometimes there were cases where a report has not been solved in very long time because of the form where the report has been recorded was lost.
6. Lastly, there is no knowledge base to store all documentations made from the problem solving. Without knowledge base, staffs cannot make reference if they need some information about problem they face. With knowledge base, they can fix their problem themselves and this exactly can cut the time, cost and even energy to solve the repetitive problems.

4.1.1 Change to Computerized Way

Manual practice in problem reporting is a traditional way that consumes too much time to reach the end till the problem solved. To enhance this situation, the process must be automated and computerized. What are the expectations from the computerized system are listed below:-

- Has a database that keeps the record of report.
- Update the status of each report.
- Help in classifying the report.
- Save time and speed up the process.
- More systematic and standardized.
- Has knowledge base as a reference.

In order to realize these expectations, the author has recommended the use of web-based helpdesk in new computerized system called Problem Report Management System (PRMS). PRMS is aimed to store all information about the problem reports at a central site, and enables users to access this site by various means, including e-mail, WWW, and a network daemon. New problem reports can be created, and existing reports can be queried and updated, by most of these means.

4.2 SYSTEM DESIGN

4.2.1 System Framework

The best way to computerize this traditional way is by using web-based helpdesk system. In this system, there are three main modules:-

1. Report Submission

This module is aimed to record new reports in database. This includes the processes to validate the staff, validate the content of the report and alert administrators about new submission.

2. Report Management

This is main part of the system where it is used to manage all reports in database. This includes classify the report according to the status, process the report and then update the status.

3. Knowledge Management

This module is used to manage knowledge in this system. After a problem is solved, the documentation will be made and stored in knowledge base so the staffs can access and benefit from it.

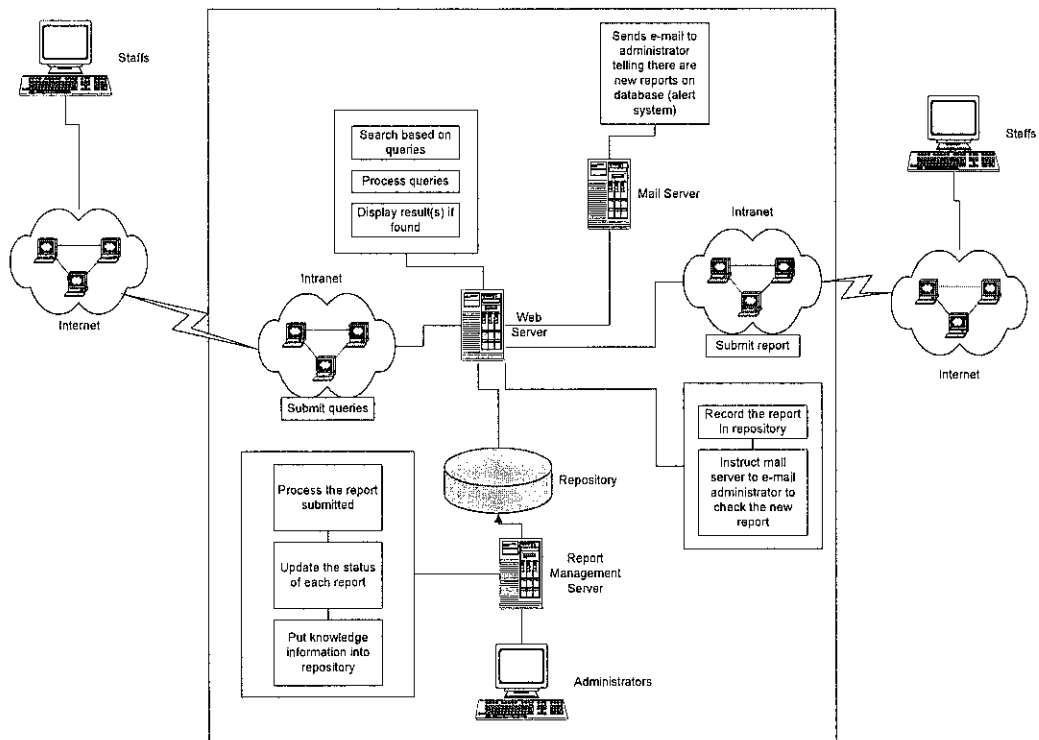

Figure 4.2 Proposed system framework

4.2.2 System Functionality

There are three types of people who involve in the system:-

- **Staffs** - Staffs are considered as all employees in Ministry of Information that use any computer related technology such as hardware, software, system and etc.

- Administrators – People who are responsible in managing all computer related problems reported by staffs and manage the system. They consist of IT people, technicians, system administrators and database administrators.
- Vendor/IT people – people who is assigned by administrators to solve the problem.

Figure 4.3 is a use case diagram shows the functionality of the new system. The new system is supposed to have eight functions:-

1. Submit report
This is done by staffs who want to report a problem.
2. Request knowledge
Both staffs and administrators can request for knowledge and the system will response.
3. Check report
Administrators can check any report to manage and take action.
4. Check staff and inventory information
Administrators can check information about staffs and inventory of related hardware or software to investigate in detail.
5. Add and manage knowledge
Administrators can add new knowledge as well as manage them in effective way.
6. Update status of reports
Administrators can update the status of a report whether it is being investigated or it is being taken action or the problem is solved.
7. Validate and record maintenance report
Once a vendor or staff who is responsible in solving the problem has done their job, they will come out with a maintenance report. The maintenance report then would be validated by administrators and they will record the report in the database.
8. Submit maintenance report

Vendor or people who are assigned to solve the problem would submit maintenance report manually upon completion of their job.

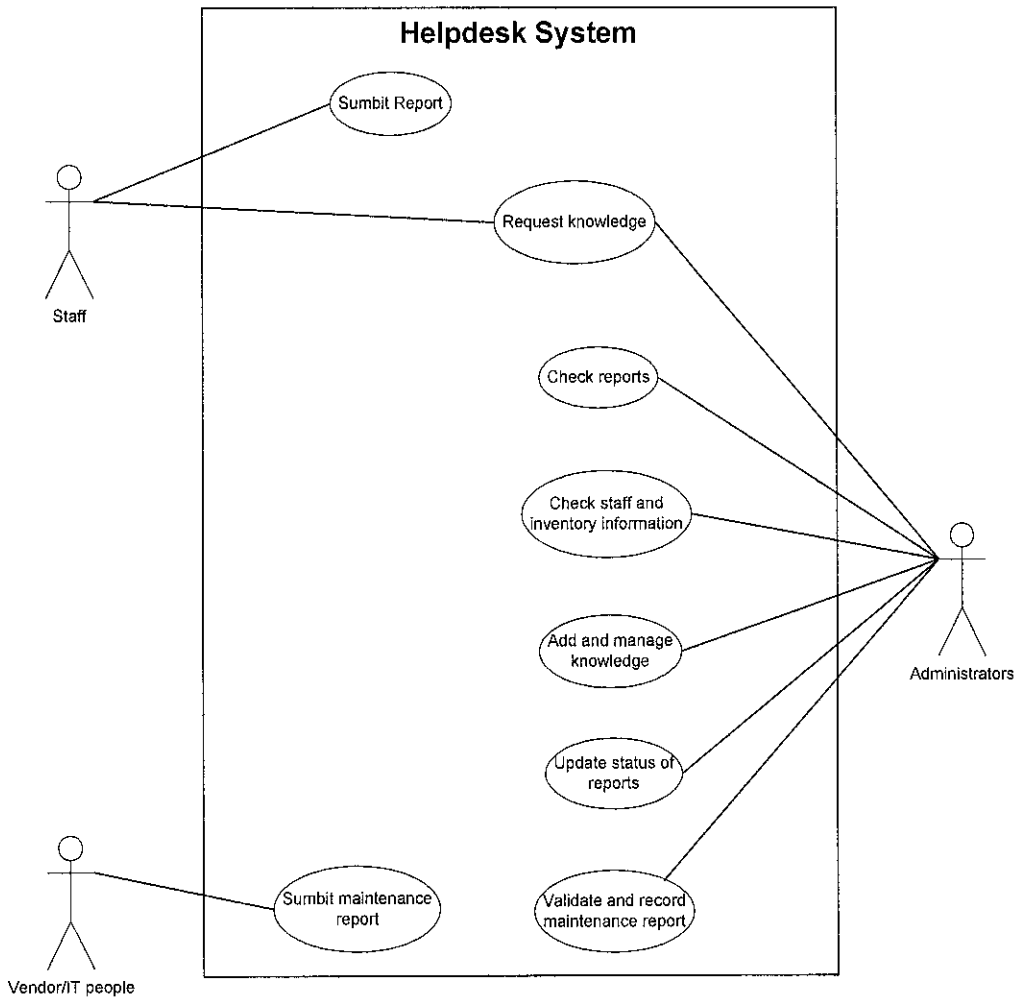

Figure 4.3 Use Case Diagram of Helpdesk System

4.2.3 System Workflow

As knowledge base is integrated in the new system, staffs have other alternatives to solve the problem. Staffs can solve the problem by using the knowledge base rather than report it to the HQ or they can just skip from using that knowledge and proceed to report the problem. Figure 4.4 shows the ways staffs can choose to solve their problems.

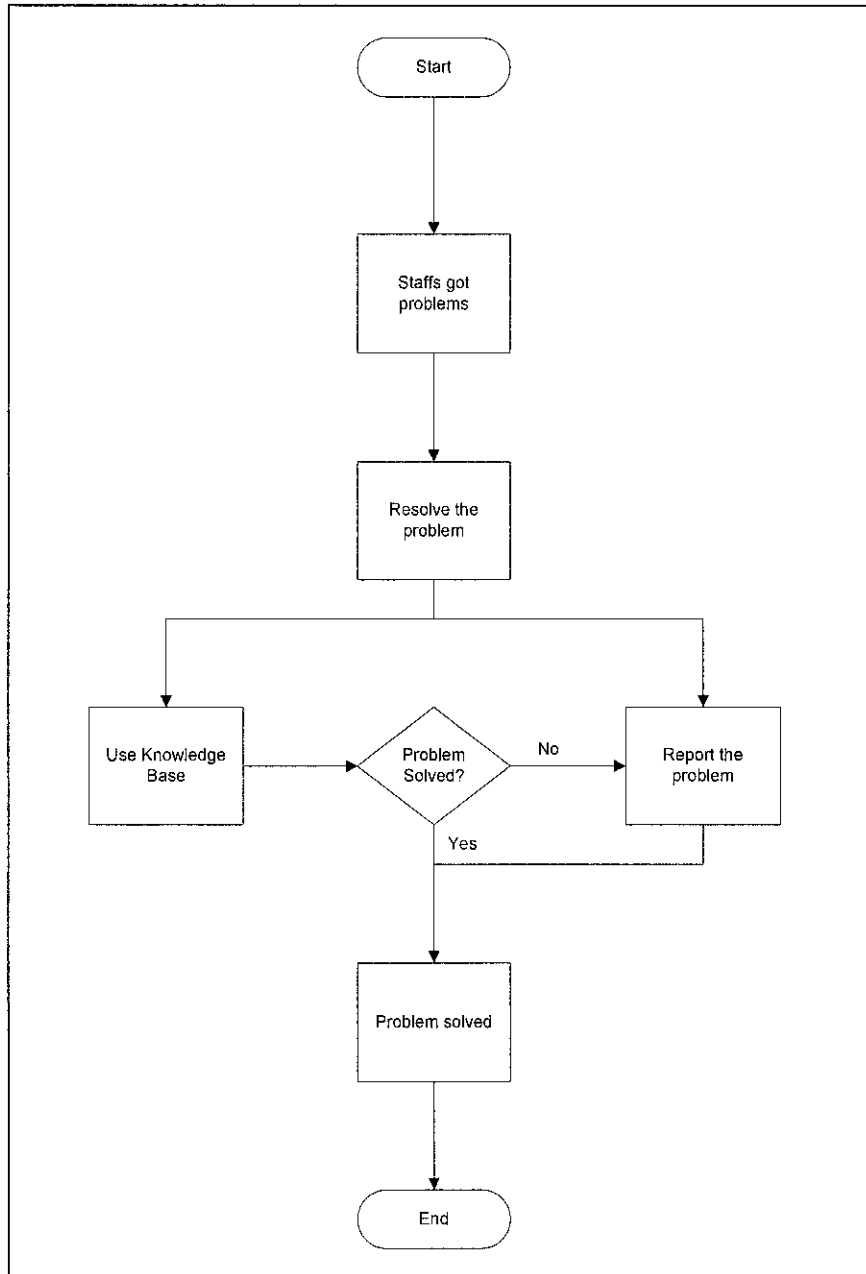

Figure 4.4 New workflow using helpdesk system

With the adaptation of new knowledge base, the process can be cut to more time saving. In Figure 4.4.1, it states that if a staff gets problem in his computer, he can firstly access this knowledge base and check for the previous same problem. He can apply previous techniques to solve the problem. If it is not working, only then they submit the report. If they can fix it using the knowledge stored, the problem is perceived as solved at early stage of this system.

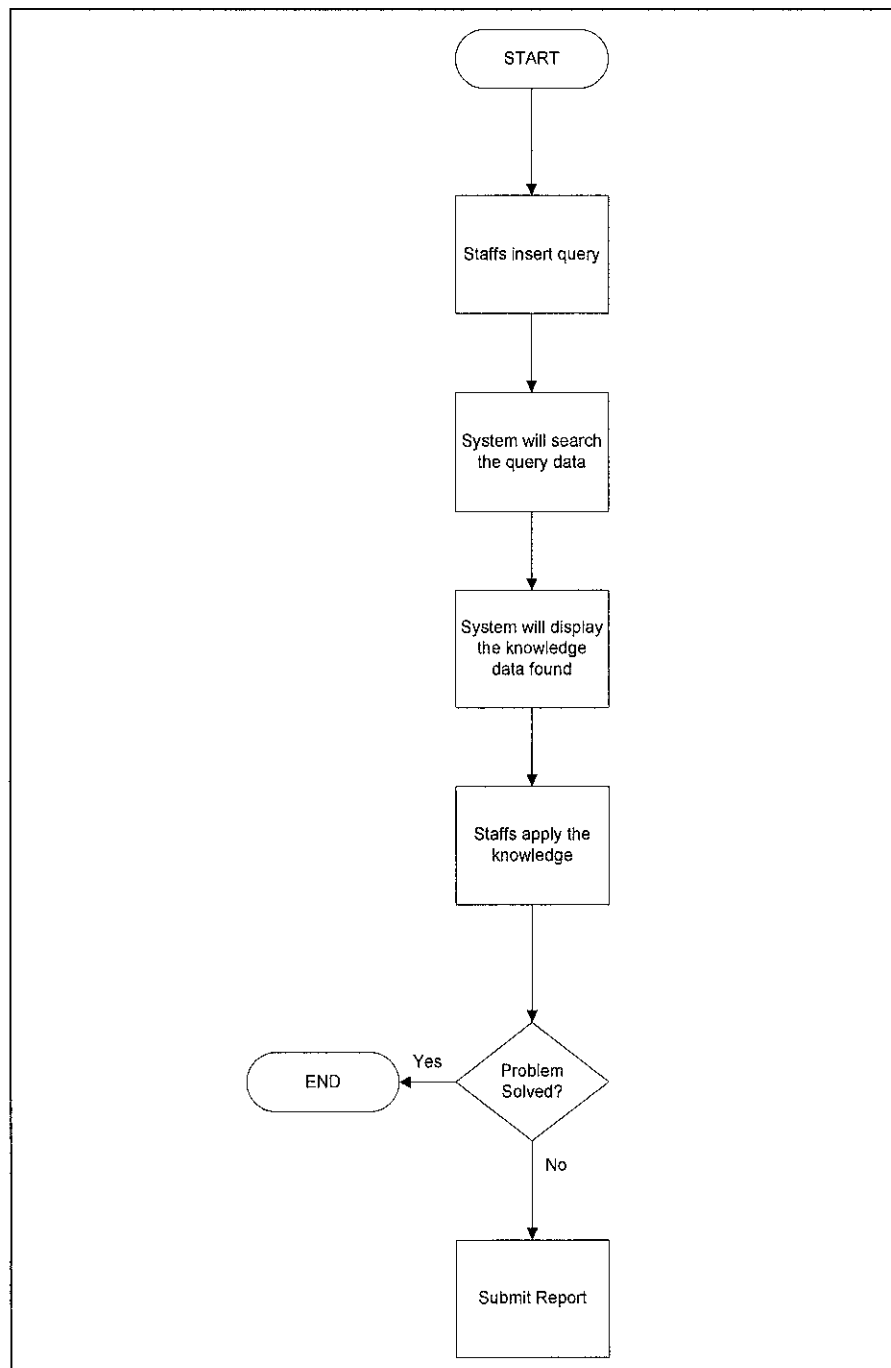

Figure 4.4.1 Detail workflow on using knowledge base

Figure 4.4.2 shows detail workflow on how staffs can report problem if they didn't find it in knowledge base or skip from using the knowledge base. In new computerized system, the helpdesk system will computerize most activities. It includes the form used to report the problem. Then the report will be stored in database by the system. The system then will alert all administrators about new record submission through email and short messaging system (sms).

Administrators will check the report and investigate the report. If the problem identified, they will ask the staff to solve the problem themselves. If the problem cannot be solved, they will plan for maintenance and assign people or vendor to solve it. After fixing the problem, they will document the way they use to solve the problem and administrators will store it in knowledge base.

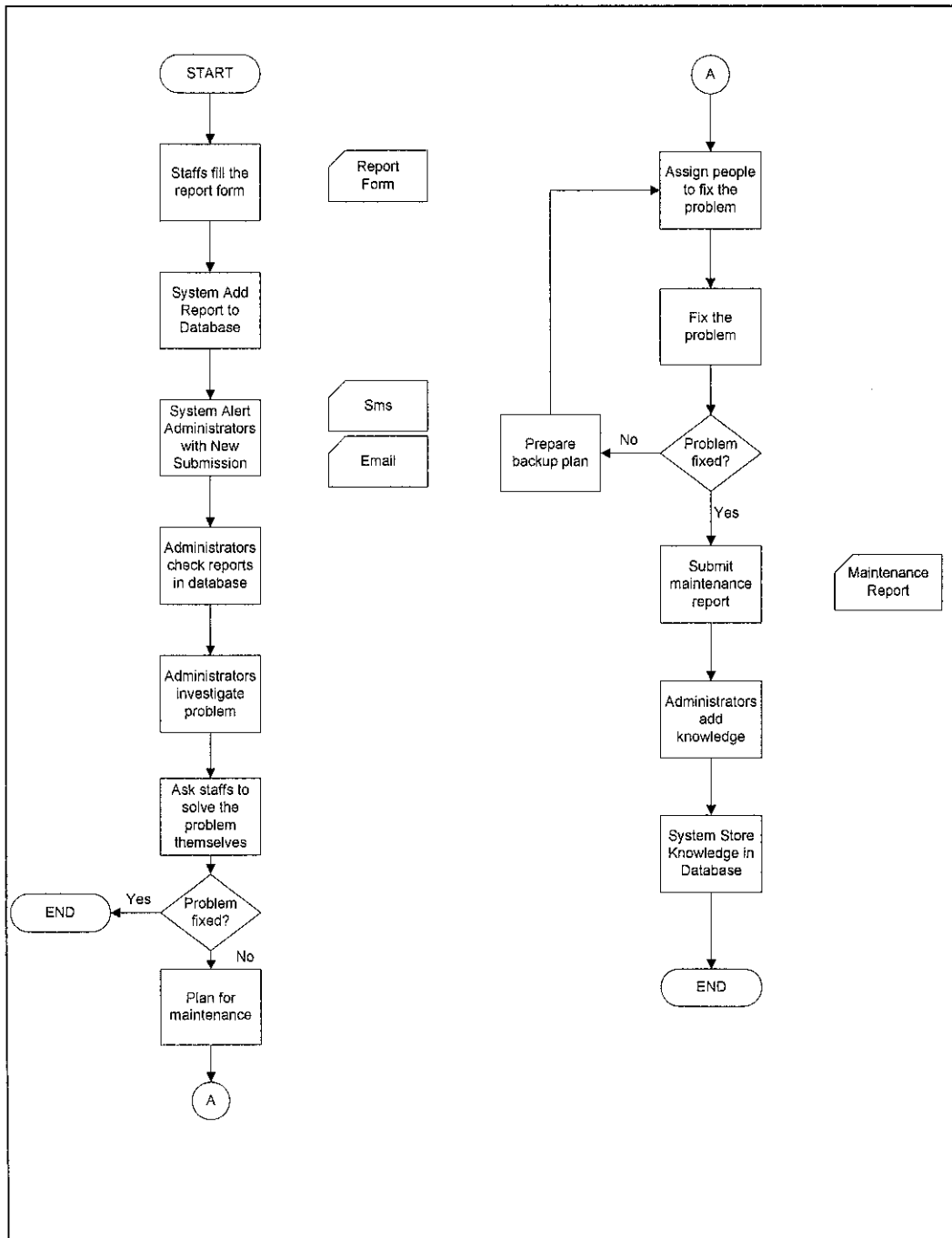

Figure 4.4.2 Detail workflow on reporting a problem

4.2.4 System Interaction

Based on workflow design in the previous section, an activity diagram can be constructed to show the interaction among entities.

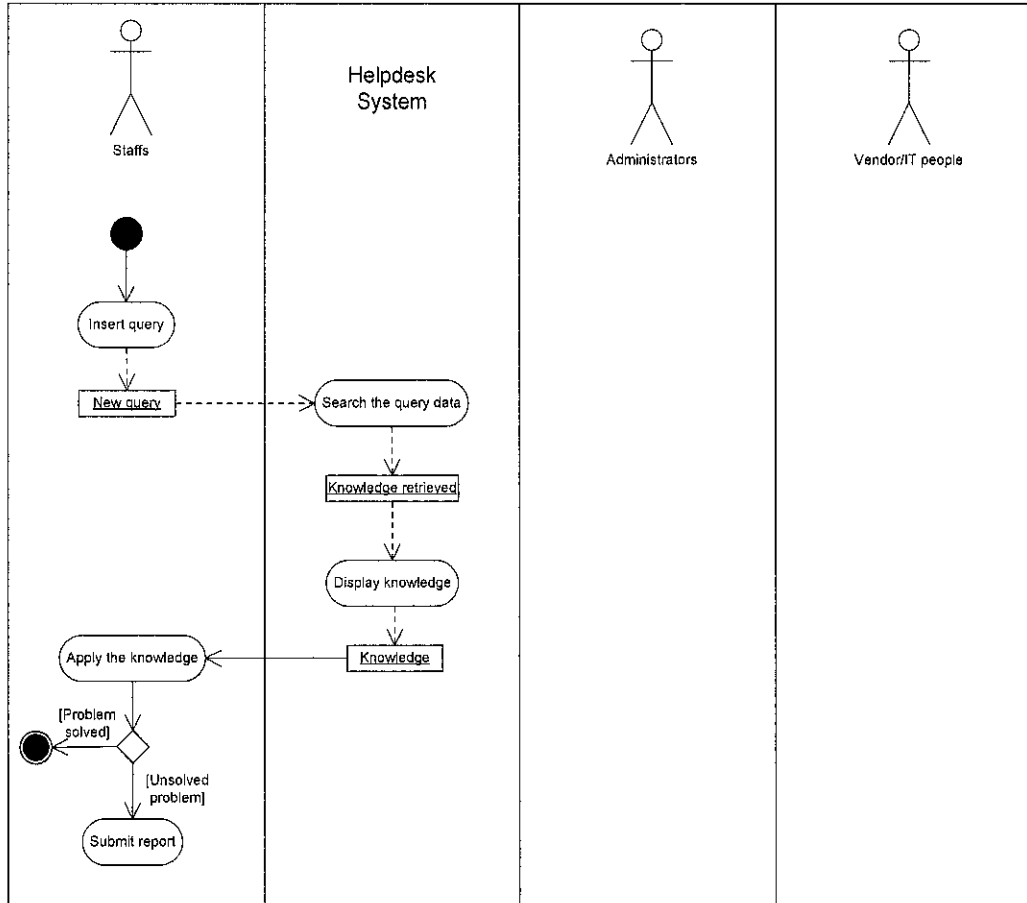

Figure 4.5.1 Activity Diagram for Problem Solving Based on Knowledge

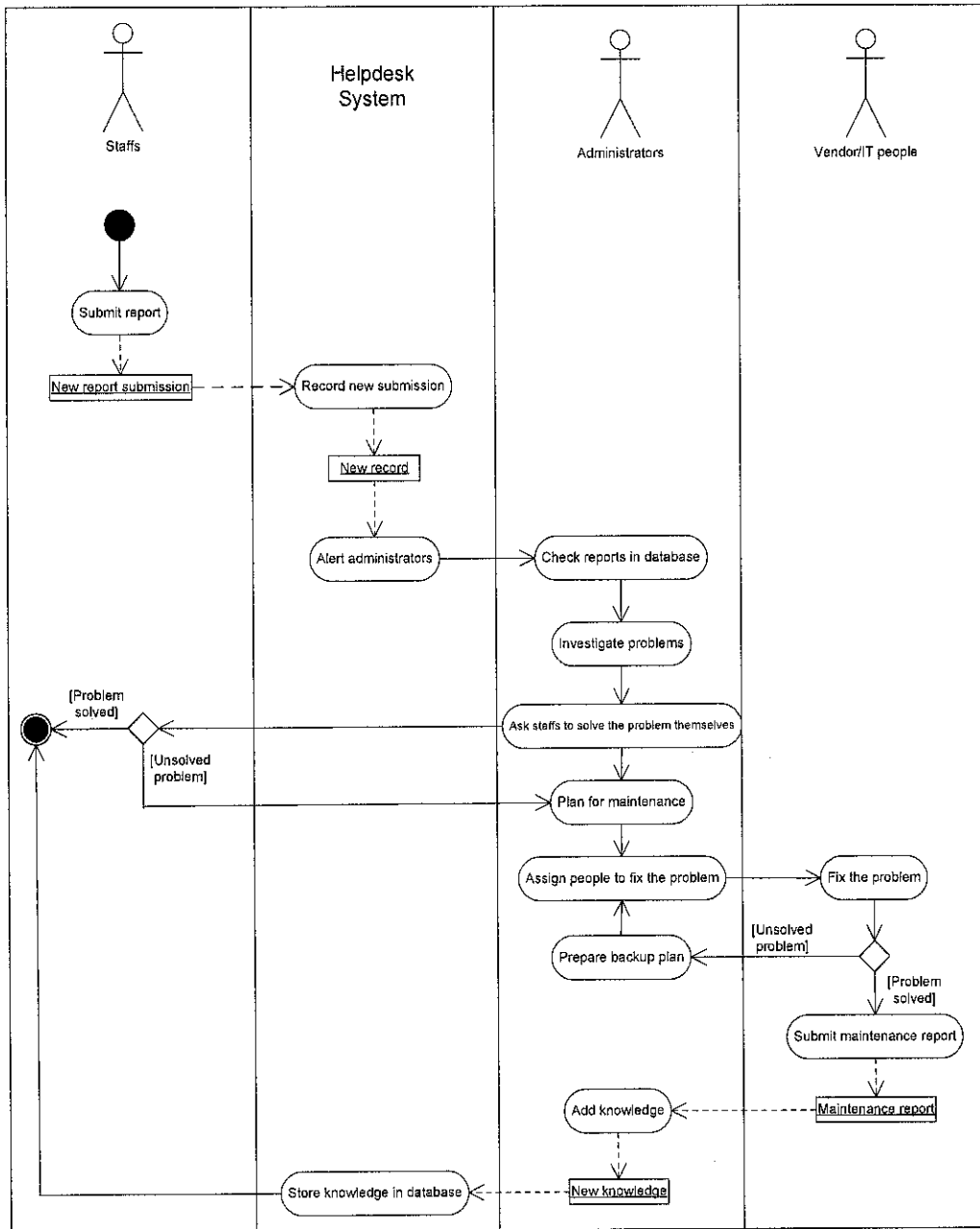

Figure 4.5.2 Activity Diagram for Problem Solving Based on Problem Reporting.

4.3 THE PROTOTYPE

For this project, a prototype developed to show how the actual product would be. The prototype is supposed to work same like a helpdesk system. This section will discuss about technical design aspect of the final system.

4.3.1 Data Flow

In this section, there will be diagrams to show the flow of data in this helpdesk system. The Data Flow Diagram (DFD) is used to show the technical aspect of design. Figure 4.6 is Context Level DFD that shows the high level data flow between system and its external entities.

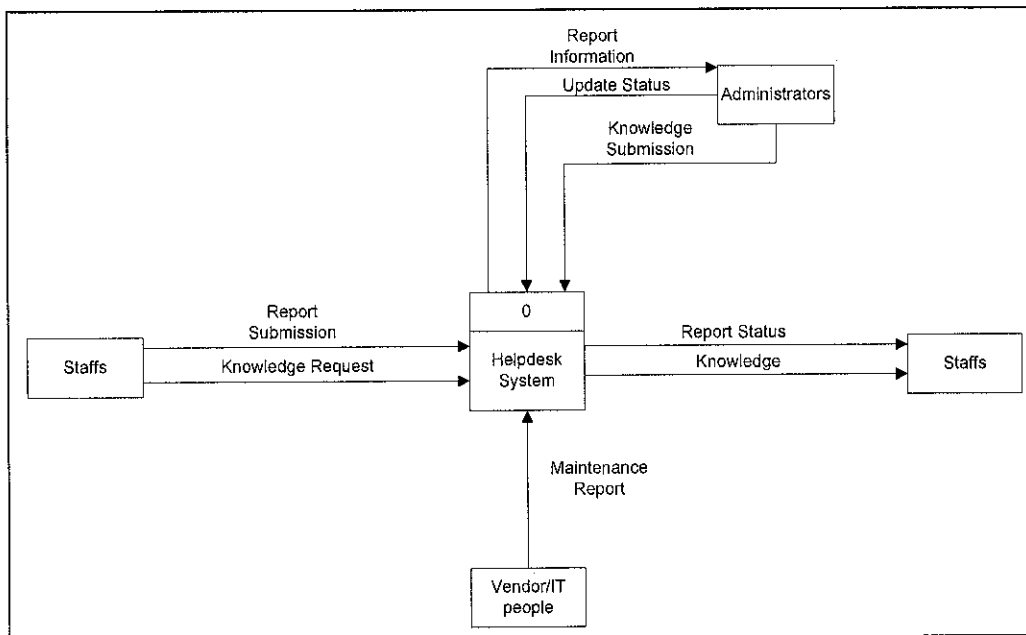

Figure 4.6 Context-level DFD for Proposed System

Staffs interact with the system by submitting report and requesting knowledge. Then the system will response by giving them the status of their report and knowledge they request. Administrators get report information including the status of the report from the system. After solving the problem, they will update the status of the report and submit any related knowledge to fix the problem. Vendor is the person who is assigned to fix particular problem and they will submit maintenance report manually to the administrators.

Figure 4.6 shows Diagram 0 DFD for this system. This is more detail diagram to show the data flow of the system. There are eight main processes:-

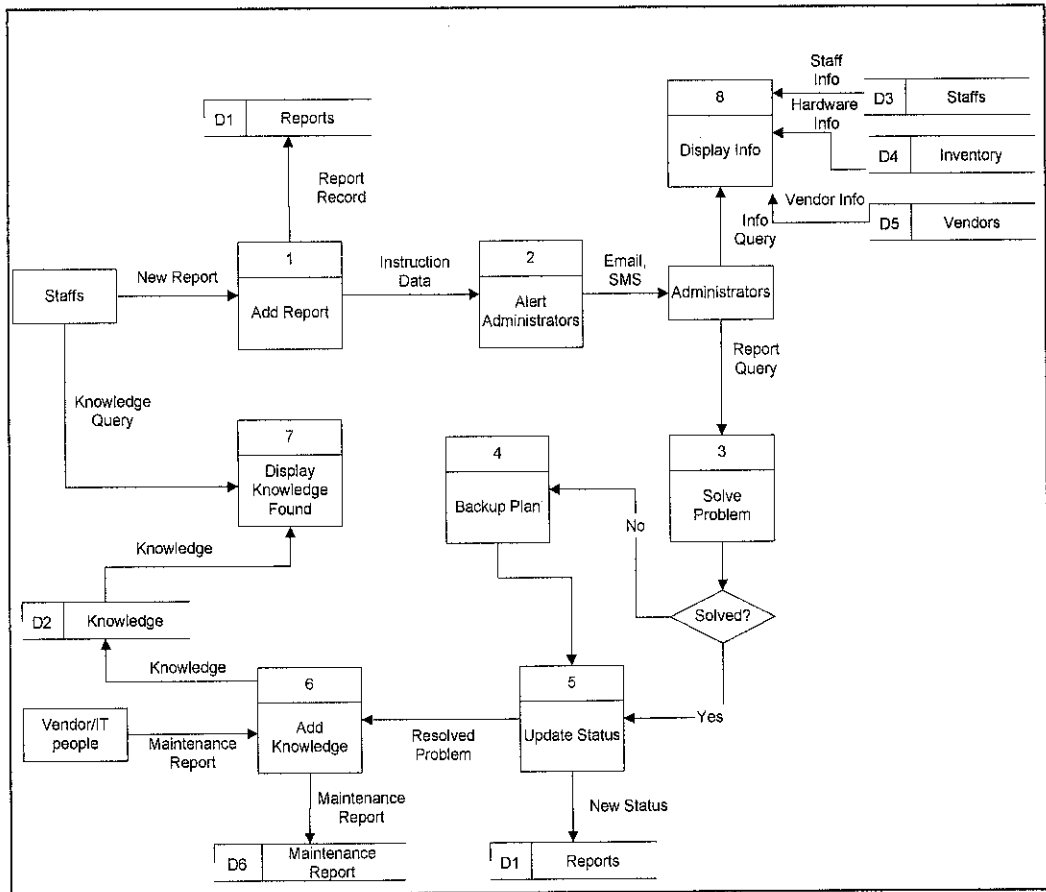

Figure 4.7 Diagram 0 of the Proposed System

1. Add Report

This process represents the new report submission by staffs and the report will be stored in database.

2. Alert Administrators

This process represents the alert system that will alert administrators about new report submission.

3. Solve Problem

In this process, administrators will ask for unresolved report and investigate the report. After identifying the problem they will solve it through identified

steps. It includes asking the staffs to solve the problem themselves. If they cannot make it, HQ will plan for maintenance and assign people or vendor to solve it.

4. Backup Plan

This process represents the alternative way used if the problem cannot be solved.

5. Update Status

This process represents the status updated by administrators each time they have fixed a problem.

6. Add Knowledge

After each completion of problem solving, the maintenance report will be sent to system and system will store it in knowledge base.

7. Display Knowledge

The process shows the knowledge request from staffs and system will search it in knowledge base and display it to staffs.

8. Display Information

This process shows the information request from administrators about the staffs, vendors and related hardware. These are supplemental information used by administrators in order to make decision.

(Please refer to Appendix A for detailed DFD for each process).

4.3.2 System Interface

In this part there would be interface designs to show how the prototype looks like. But the designs are limited to show only important functions of the system.

For staff

- **Report Submission**

Submit Report
Please Fill In Required Fields(*)

Date : April 12, 2004

Problem Description : *

Symptom : *

Problem Type : *

Seriousness : *

Reported by : faizul

Figure 4.8 Interface design for report submission

- Staffs can list down reports they made.

Reports Search	
This module is aimed to help a staff to find reports made by him/her.	
Report ID :	<input type="text"/> <input type="button" value="SEARCH"/>
There are 12 reports made by faizul.	
[14] My memory is low	
Type of problem - hardware Status - no action Seriousness - high	
Submitted by faizul on 13/04/2004 time 23:33:38	
[13] New product training	
Type of problem - product Status - no action Seriousness - high	
Submitted by faizul on 13/04/2004 time 23:31:06	
[12] Network slow	
Type of problem - network Status - complete Seriousness - high	
Submitted by faizul on 12/04/2004 time 12:48:54	
[11] Microsoft Word	
Type of problem - software Status - complete Seriousness - high	
Submitted by faizul on 12/04/2004 time 01:13:20	

Figure 4.9 Interface design for report search

- Staffs can see detail of each report they made.

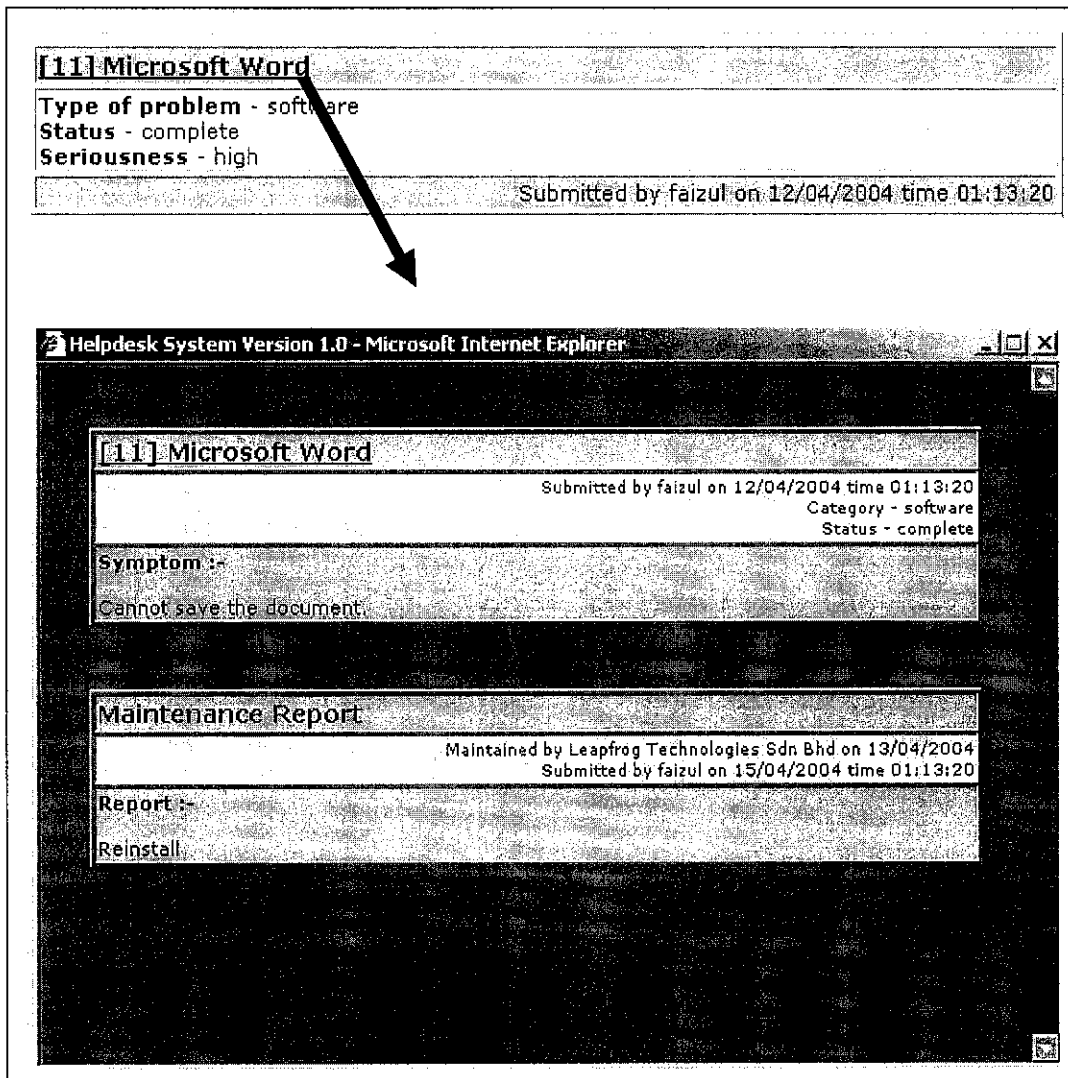

Figure 4.10 Interface design for report details

- Staffs can search for knowledge.

Search Knowledge

This module is aimed to help staffs to find any knowledge they want.

Select Criteria(s)

Look for :

Problem Type :

There are 1 results for 'virus'.

Worm & virus

Submitted by faizul on 2004-04-18
Category virus

[Home](#)

Figure 4.11 Interface design for knowledge search

Helpdesk System Version 1.0 - Microsoft Internet Explorer

Worm & virus

Submitted by faizul on 2004-04-18
Category virus

[Home](#)

Symptom

PC restart automatically after minutes.

Cause

Virus enter into the pc

Solution

1. Unplug your network cable.
2. Install latest Virus definitions.
3. Install Zone Alarm FireWall.
4. Now run all the worm removal tools: FixWelch, FixBlast, Stinger.
5. Then apply the given patches.
6. After that, run Avast Scanner.
7. Then, restart ur pc.
8. Finally, run Avast Scanner again.
9. Plug your network cable.
10. Zone Alarm will trigger saying that a new network is detected. In the option given, don't set it to trusted network. Use the other option.
11. Check your Zone Alarm configuration when a program is trying to access the network/Internet.

Figure 4.12 Interface design for knowledge details

For administration

- Administrators can search for report and manage each report.

View Reports

Select Criteria(s)

Report ID :

OR

Status :

Seriousness :

Problem Type :

Result for report id 12

ID	Date	Category	Status	Seriousness	Problem Description
12	12/04/2004	network	complete	high	Network slow

Figure 4.13 Interface design for report search

[12] Network slow

Information

Submitted by **Kamarul Nizam** on 12/04/2004 time 12:48:54
Location - 1-11, Dewan SUK, Jubli Emas, Shah Alam, Selangor
Category - network
Status - complete
Seriousness - high

Category -

Status -

Seriousness -

Symptom :-

Network very slow.

Action Information

Action taken by Leapfrog Technologies Sdn Bhd on 13/04/2004
Submitted by faizul on 14/04/2004

Report :-

Upgrade lan.

Add To Knowledge

Do you want to add this report to knowledge base?

Figure 4.14 Interface design for report management

- Search for active vendors.

Search - Vendor

Select Criteria(s)
 Look for top (number) most active vendors
 based on (type of problem)

Top 5 active vendor(s) for all problem.

Leapfrog Technologies Sdn Bhd
Maintain 8 total report(s) for all problem
See all problems maintained by this vendor.
Microsoft Sdn Bhd
Maintain 1 total report(s) for all problem
See all problems maintained by this vendor.

Figure 4.15 Interface design for vendor search

- Generate statistic for all reports

Statistic - Report

Select Criteria(s)
 Display statistic for total amounts of report based on :

Statistic for total reports for each type of problem.

software		4 (30.77%)
hardware		3 (23.08%)
system		2 (15.38%)
virus		2 (15.38%)
network		1 (7.69%)
product		1 (7.69%)

There are 13 total reports in database.

Figure 4.16 Interface design report statistic.

4.3.3 System Requirement

- **Tools for Development**
 - Hypertext Preprocessor Language (PHP)
 - Apache web server version 2.0.43
 - Adobe Photoshop 7.0
 - Mysql database server version 2
 - Php editor
- **Server**
 - Processor Pentium 3 600 MHz and above
 - Microsoft Windows 2000/NT/XP and Linux
 - 128 SDRAM
 - 5 GB available hard disk
 - Web Server (Apache).
- **Client**
 - Pentium – class processor.
 - Microsoft Windows 98/ME/2000/NT/XP
 - 32MB of RAM.
 - 30MB of available hard-disk space.
 - Web browser support.
 - Internet Explorer 5.0
 - Netscape Navigator 4.5 to 4.77, 6.1

4.4 DISCUSSION

In this section, there will be some discussion about advantages and disadvantages of the system and some other discussion such about implementation of knowledge base and other issues.

4.4.1 Advantages

There are a lot of advantages when a manual system becomes computerized. In this helpdesk system most of the activities are computerized and this computerization makes this system easier and more efficient. Below are some of the advantages of helpdesk system:-

- **More Standardization**

Using this new system, staffs can only make report through electronic form. This will standardize the way staffs make a report. It is different from traditional way which using multiple ways to report problem.

- **Easy Report Access and Manipulation**

After submitting reports, they will be stored in database. Locating all reports in database makes it easy to access the reports and manipulate all information about the reports. The status of the reports can be updated timely to ease the classifying of reports so administrators can easily pick up any report to solve.

- **Report Classifying**

The system can classify reports according to status of the reports. This function helps administrators in selecting the reports according to their interest. For example, administrators can classify the reports whose status are 'unsolved' so they can investigate those reports.

- **Knowledge Management**

In this new system, knowledge management becomes a major part of it. Knowledge is managed as it is a knowledge management system. After solving a problem, maintenance report will be sent to administrators and they will store it in knowledge base. Staffs can access this knowledge to solve their problems.

4.4.2 Limitations

As the system is intended to be used nationwide, the issue on who is responsible to manage the report can be a problem. At the moment, all reports are managed by administrators located at headquarter. This sometime take long time since they have to manage too many reports gathered from all states. Since reports have to be solved one by one a problem cannot be solved within a short time. One of the solutions is to distribute administrative task to state administration. Doing this can speed up the problem solving activity since less problems must be managed for each state administrators.

Another issue is reports are solved based on each priority. If there is a problem with low priority and at the same time many reports have been marked as high priority then it will be delayed. Because of that, a procedure on which problem should be considered as high, medium or low priority must be developed and followed.

Another limitation is on alert system. The system is designed to alert administrator in two ways; email and sms. Sms is used as alternative to email since email is not always being accessed and moreover sms has advantage on its portability. But the implementation of sms in this system is based on sms through mail server. It doesn't guarantee immediate sms sending since an email must be relayed before it is sent.

The limitation of this web-based helpdesk system is more likely same to other web-based system. If the Internet is used as communication medium, the issues like virus attack, database security and many more are included in some of the disadvantages.

We cannot expect a new virus attacking our system and because of that this would be the most limitation of this web-based system.

4.4.3 Knowledge Management as Organizational Learning and Decision Support Services

The implementation of knowledge management in the helpdesk system is aimed to teach users new knowledge as a mean to provide them with essential information related to their works. Knowledge management system in helpdesk can support users in two ways:-

1. Give information to staffs about solution of problem they encounter.
2. Give decisive information to administrators to help them in making decision.

Helpdesk with knowledge base helps staffs to see historical data about the same problem they face and the related solution for that problem. With this capability staffs can make query for any problem they have and system will display the results.

Administrators use knowledge base in making decision. For example, in making decision on who will be assigned to solve a problem, administrators will look to historical database on vendors that are sorted according to their performance (Assume that performance is measured on the total times they successfully solve the problem). From that information, administrators would choose the best suited with their interest after considering some other aspect such as problem they solve, where it was solved, their relationship with government and etc.

Figure 4.7 shows the relationship between data, information and knowledge based on previous example.

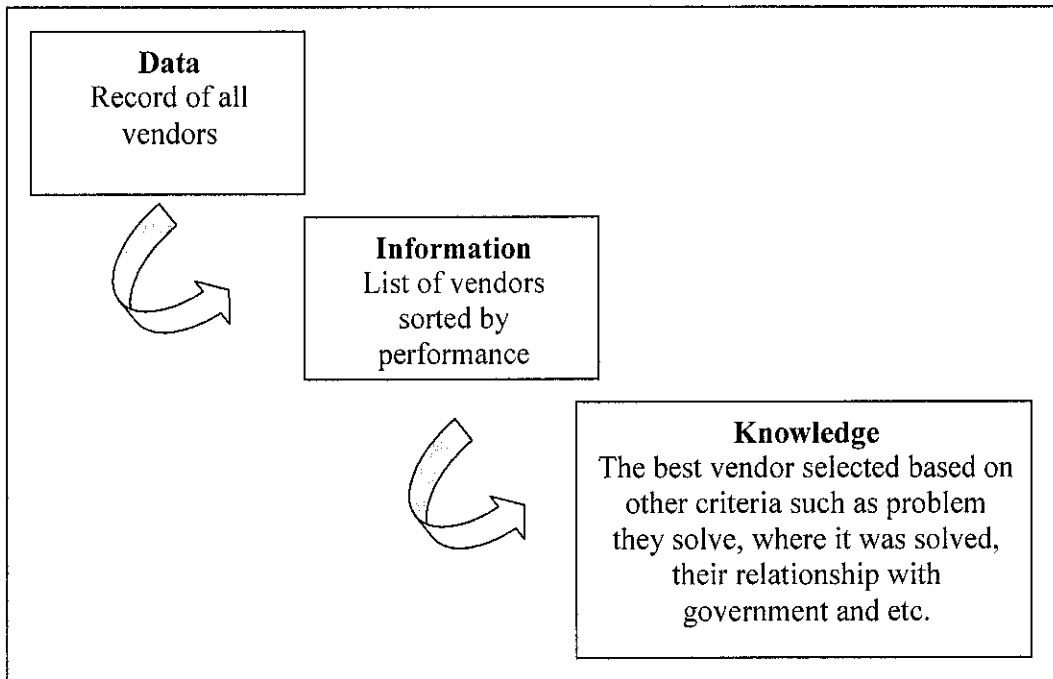

Figure 4.17 Interaction of data, information and knowledge

CHAPTER 5

CONCLUSION AND RECOMMENDATION

5.1 CONCLUSION

As a conclusion, the implementation of computerized web-based helpdesk system or PRMS gives maximum benefit to IT department of Ministry of Information. It cuts the time used to search report in traditional manual process by using database as storage medium. Moreover, the implementation of knowledge management in this system would be advantage to the department as the total amount of reports decreased at earlier stage. The study on workflow would describe the system clearly on how actually the system works, the flow of process and the interaction among entities. The PRMS can help in cutting cost with providing paperless environment. Lastly, the system would give benefit to IT department of Misnistry of Information in managing the problems that are encountered by staffs in the country.

5.2 RECOMMENDATION

For future improvement, there are some issues to be considered:-

1. Current prototype only apply KM in very limited aspect. Future PRMS can apply many more KM application such as graph, statistic and etc.
2. Current prototype doesn't give permission to vendors to submit their maintenance report through the system due to security issue. For future PRMS, the system can accept the vendors but with very limited access.
3. Current prototype is still limited in some aspects like design and other functionality. Future upgrade should consider any new feature to enhance the system.

REFERENCES

- [1] Carol Prior 2002. *Workflow and Process Management*, Maestro BPE Pty Limited, Australia.
- [2] Teresa L. Ju 2001. *Process Definition for Adaptable Workflow Management Systems*, Department of Information Management, Su-Te University, China.
- [3] Howard Smith & Peter Fingar. November 2003. *Workflow is just a Pi process*, Computer Sciences Corporation.
- [4] *Glossary of Term*, < <http://hydra.gsa.gov/anywhere/glossary.htm> >
- [5] Konica Business Technologies 2002, *Helpdesk Tracker – Customer Issue Management System*, Konica Business Technologies, Inc.
- [6] Intecs Sistemi Group 1996, *Technology Briefing Report on Process Support*, Renaissance Consortium.
- [7] Hallvard Trætteberg 1999, *Modeling work: Workflow and Task modeling*, Norwegian University of Science and Technology.
- [8] Akira Takano 1996, *Procedure Based Help Desk System*, Mitsubishi Electric Corporation
- [9] George Mason University 1999, *An Introduction to Workflow*, < <http://cne.gmu.edu/modules/workflow/index.html> >
- [10] PeopleSoft Consulting 2003, *Workflow and Automated Processes*, PCS Consulting.
- [11] Daniel E. O’Leary 1998, *Enterprise Knowledge Management*, University of Southern California.
- [12] Dick Stenmark 2002, *Information vs. Knowledge: The Role of intranets in Knowledge Management*, Volvo Information Technology.
- [13] Gene Bellinger, Durval Castro, Anthony Mills 2004, *Data, Information, Knowledge, and Wisdom*, Gene Bellinger, OutSights, Inc.
- [13] Sinan Si Alhir, *Learning UML*, O’Reilly.

APPENDIX A
(Detailed Data Flow Diagram (DFD))

- Diagram 1 of the proposed system for process 1 (Add Report).

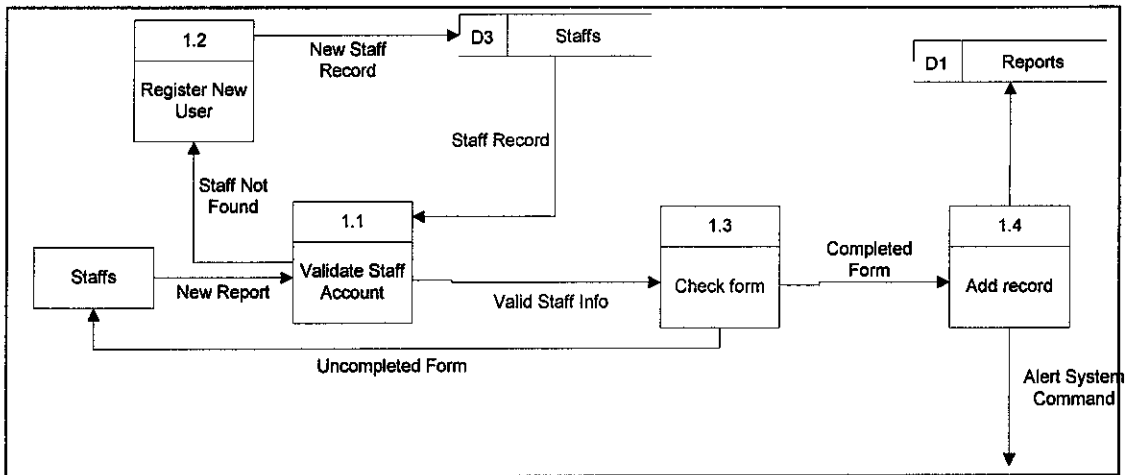

- Diagram 1 of the proposed system for process 2 (Alert Administrators).

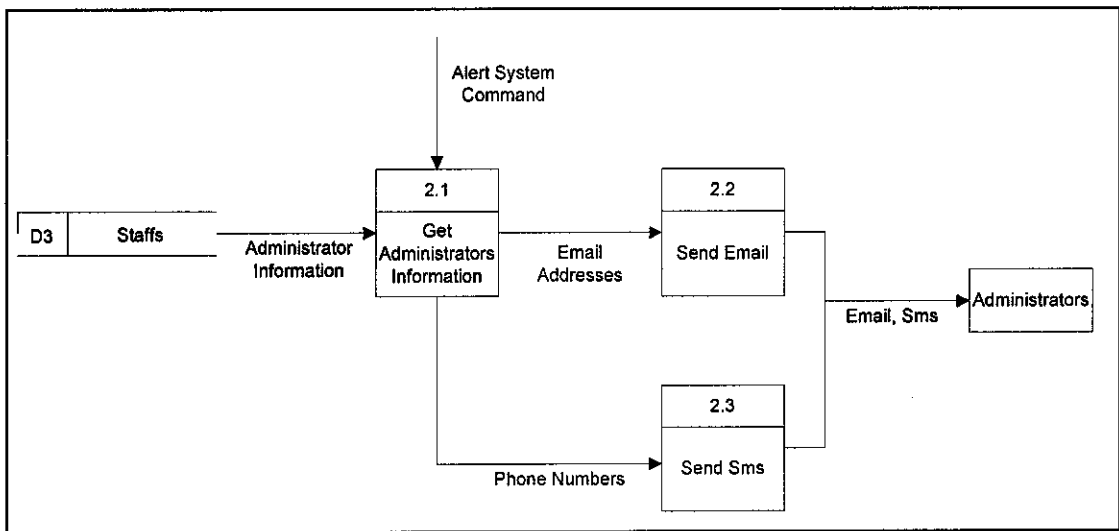

- Diagram 1 of the proposed system for process3 (Solve Problem).

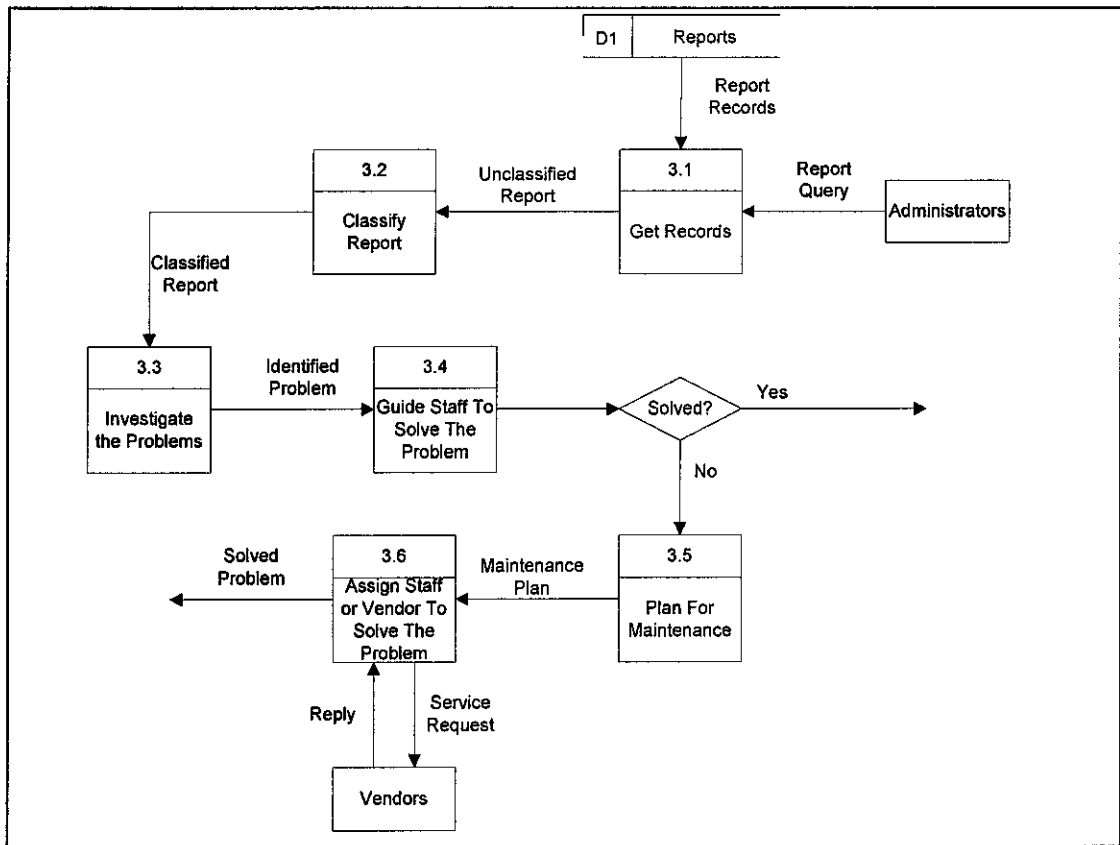

- Diagram 1 of the proposed system for process 4 (Backup Plan).

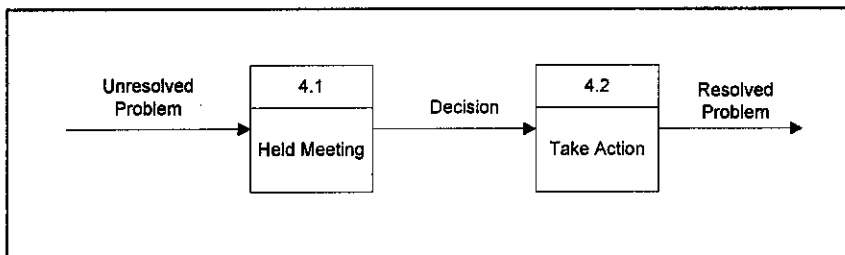

- Diagram 1 of the proposed system for process 5 (Update Status).

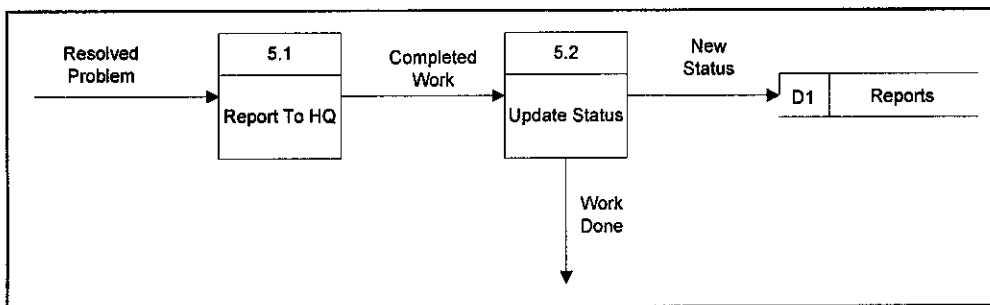

- Diagram 1 of the proposed system for process 6 (Add Knowledge).

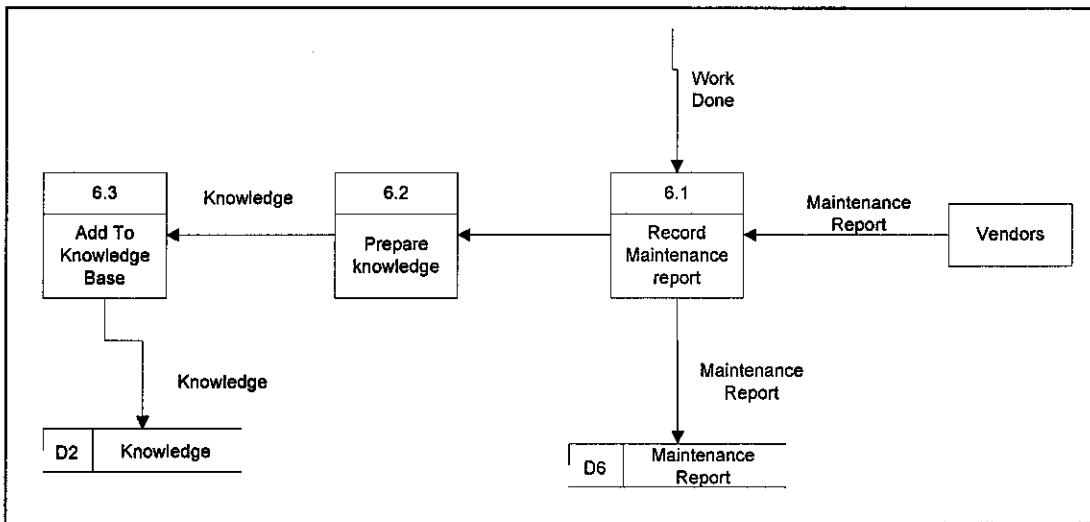

- Diagram 1 of the proposed system for process 7 (Display Knowledge Found).

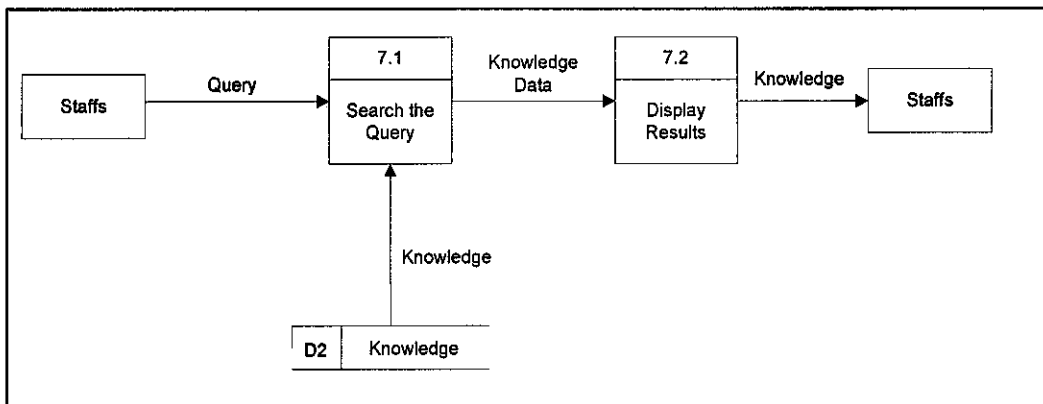

- Diagram 1 of the proposed system for process 8 (Display Info).

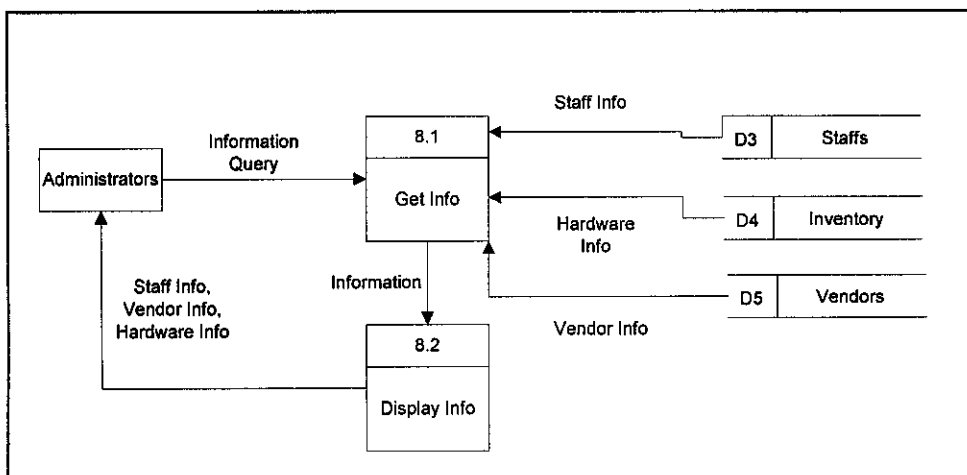

APPENDIX B
(Gantt Chart)

