

**DESIGN AND IMPLEMENTATION OF TEMPERATURE MONITORING
USING ZIGBEE WIRELESS TECHNOLOGY**

By

MOHD ZULHELMI BIN SHAMSUDIN

FINAL PROJECT REPORT

Submitted to the Department of Electrical & Electronic Engineering
in Partial Fulfillment of the Requirements
for the Degree
Bachelor of Engineering (Hons)
(Electrical & Electronic Engineering)

Universiti Teknologi PETRONAS
Bandar Seri Iskandar
31750 Tronoh
Perak Darul Ridzuan

© Copyright 2013

by

Mohd Zulhelmi Bin Shamsudin, 2013

CERTIFICATION

CERTIFICATION OF APPROVAL

DESIGN AND IMPLEMENTATION OF TEMPERATURE MONITORING USING ZIGBEE WIRELESS TECHNOLOGY

By

Mohd Zulhelmi Bin Shamsudin

A project dissertation submitted to the
Department of Electrical & Electronic Engineering
Universiti Teknologi PETRONAS
in partial fulfilment of the requirement for the
Bachelor of Engineering (Hons)
(Electrical & Electronic Engineering)

Approved:

Dr Hanita Bt Daud
Project Supervisor

Ir Dr Norsyarizal B Mohd Nor
Project Co. Supervisor

UNIVERSITI TEKNOLOGI PETRONAS

TRONOH, PERAK

May 2013

CERTIFICATION OF ORIGINALITY

This is to certify that I am responsible for the work submitted in this project, that the original work is my own except as specified in the references and acknowledgements, and that the original work contained herein have not been undertaken or done by unspecified sources or persons.

MOHD ZULHELMI BIN SHAMSUDIN

ABSTRACT

The human body temperature is one of health factors that needs to be monitor continuously especially for those who are suffering in health problem because in can lead to severe condition. Currently in Malaysia, there are still no continuous monitoring systems even in hospitals. The project will be focus on temperature sensing and displaying the result continuously. The objective of the author to do this project is to design and implement an effective body temperature monitoring system through the best wireless network as transmission medium. This approach is selected to research and use the Zigbee Wireless Network as the communication medium. Zigbee Wireless Network is new emerging technology which had been discovered centuries ago as suitable system in transmitting long range information. Thus this project is based on implementing Zigbee wireless network as solution in solving the ineffective wireless temperature monitoring.

ACKNOWLEDGEMENTS

Alhamdulillah. Thank to God Almighty because of HIS greatness and power, I succesfully completed this Final Year Project. I am very grateful to Allah SWT because i had achieved the objectives of the project greatly. From this project, I had experience and learn a lots by gaining new knowledge and had done the application of the knowledge. With the help of Allah SWT, who had gave me awareness to become more responsible and appreciated on what other people help me to finish this project.

Therefore, I would like to give my highest appreciation to my supervisor and co-supervisor of my Final Year Project, Dr Hanita Daud and Ir. Dr. Nursyarizal Bin Mohd Nor for their support, improving ideas and good guidance for me towards completion of the project. With their guidance and advices every week help me to keep improving my skill and knowledge in Electrical and Electronic Engineering. Thus, help me to finish this project wisely.

Besides, I would also want to give my appreciation to my colleagues for their support and idea in contributing to finish this project especially to Nurul Fauzana Binti Imram Gulcharan, Muhammad Afham Bin Mohd Azhar, Muhammad Izzudin Bin Mohd Sani, Muhammad Zulfadhli Bin Abdul Rahman, Muhammad Rusydi Bin Mashhor and Abdillah Bin Nasib.

Apart of that, of course thousands of thanks to my family members who support me morally throughout this project undergoing.

Last but not least, I would also want to give my appreciation to all laboratory technicians and all the people who contribute to this project directly or indirectly. Without all of them, I might not finish this project greatly. Thank you very much for all the supports, ideas and guidances to me to complete this project.

TABLE OF CONTENT

CERTIFICATION.....	2
ABSTRACT.....	4
ACKNOWLEDGEMENTS	5
TABLE OF CONTENT	6
LIST OF TABLES	9
ABBREVIATIONS AND NOMENCLATURES.....	10
CHAPTER 1.....	11
PROJECT BACKGROUND.....	11
1.1 Background Study	11
1.2 Problem Statement.....	11
1.3 Objective.....	11
1.4 Scope of Study.....	12
CHAPTER 2.....	13
LITERATURE REVIEW.....	13
2.0 Introduction	13
2.1 Temperature Monitoring	13
2.2 Radio Frequency Identification (RFID)	15
2.3 ZigBee Wireless Network	18
CHAPTER 3.....	20
METHODOLOGY	20
3.1 Research Methodology	20
3.2 Gantt Chart	21
3.3 Tools and main element of project:	22
3.3.1 Thermometer.....	22
3.3.2 Thermistor.....	23
3.3.3 Microcontroller	23
3.3.4 System Architecture.....	24
CHAPTER 4.....	25
RESULTS AND DISCUSSION	25
4.1 Project Design	25
4.2 Result.....	28
4.2.1 Part 1 Test.....	28

4.2.1 Part 2 Test.....	28
4.2.1 Part 3 Test.....	29
4.2.1 Part 4 Test.....	30
4.3 Discussion.....	31
CHAPTER 5.....	42
CONCLUSION AND RECOMMENDATION	43
5.1 Conclusion	43
5.2 Recommendation	43
REFERENCES.....	44
APPENDICES.....	46

LIST OF FIGURES

Figure 2.1: Diagram of RFID tag and reader [6].....	15
Figure 2.2: Block diagram of RFID tag	17
Figure 2.3: ZigBee Wireless Network Topology	18
Figure 2.4: Function of RFID and ZigBee in monitoring system	19
Figure 4.2: Preliminary design of temperature sensor prototype	25
Figure 4.3: Project design using XBee Module (used Arduino Board)	26
Figure 4.4: Design of Temperature Tag using XBee Module.....	26
Figure 4.5: Design of XBee Receiver using SKXBee to Monitor	27
Figure 4.6: Schematic Circuit Diagram	27
Figure 4.7: Three identical tags transmit to single receiver.	30
Figure 4.8: Reading Comparison between Thermistor A and Thermometer	32
Figure 4.9: Reading Comparison between Thermistor B and Thermometer	32
Figure 4.10: Reading Comparison between Thermistor C and Thermometer	32
Figure 4.11: Temperature analysis based on part of body	34
Figure 4.12: Temperature Reading of Direct Method.....	35
Figure 4.13: Temperature reading of using Thermometer	35
Figure 4.14: Temperature Reading of Subject A	36
Figure 4.15: Temperature Reading of Subject B.....	36
Figure 4.16: Temperature Reading of Subject C.....	37
Figure 4.17: Temperature Reading of Subject D	37
Figure 4.18: Range and stability measurement of sensor in outdoor environment	40
Figure 4.19: Range and stability measurement of sensor in indoor (room temperature) environment	40
Figure 4.20: Range and stability measurement of sensor in indoor (air-conditioned) environment	41
Figure 4.21: Data Display of transmitted signal from 3 different tags.....	42
Figure 7.2: Atmega 328 Pin Mapping.....	47
Figure 7.3: Atmega328P Datasheet.....	48
Figure 7.4: 16MHz Crystal Datasheet.....	49
Figure 7.5: Board Diagram of circuit using Eagle Cad.....	50
Figure 7.6: Resistance vs. Temperature of a Calibrated Thermometer against the Thermistor	53
Figure 7.7: Temperature Sensor Comparison	53

LIST OF TABLES

Table 2.1: Normal Temperature Means and Ranges from a systematic Review of the Literature Review (1935-1998) [3]	14
Table 2.2: Type of RFID tag and its characteristics.....	15
Table 4.1: Temperature sensors (thermistors) comparison	Error! Bookmark not defined.
Table 4.2: Results of temperature values	28
Table 4.3: Temperature reading of accuracy test	29
Table 4.4: Different environments of data transmission range test.....	30
Table 4.5: Comparison if different temperature sensors [2]	31
Table 4.6: The Accuracy Test of different subjects	39
Table 4.7: Range and stability in different environmental conditions	41

ABBREVIATIONS AND NOMENCLATURES

RFID	Radio Frequency Identification
Zigbee	ZigBee Wireless Network
Wi-Fi	Wi-Fi Network
°C	Degree of Celsius
°F	Degree of Fahrenheit
ADC	Analogue to Digital Converter
UHF	Ultra High Frequency
PDA	Personal Data Assistant
RX	Receiver
SYNC	Synchronizer
SB	Smart buffer
PP	Protocol processor
TX	Transmitter
TAM	Technology Acceptance Model
NTC	Negative Temperature Coefficient
PTC	Positive Temperature Coefficient
RTD	Resistance Temperature Detector
IC	Integrated Circuit

CHAPTER 1

PROJECT BACKGROUND

1.1 Background Study

World of globalization today leads us to use the concept of technology to improve our healthy life. Human's health parameters especially temperature can be monitored, by measuring using sensor. Human body temperature has respective range of threshold values that sets a human is within good and bad condition.

Human body temperature monitoring has undergone development as time moves. Nowadays it can be done through updated technology which is wireless network. Wireless network is the transmission medium between two ports which are the sender and receiver. Wireless temperature monitoring is different compared to conventional monitoring as it saving human workload and time while making human daily activities easier.

1.2 Problem Statement

Nowadays hospitals in Malaysia, there are no continuous temperature monitoring system. Currently, in a daily ward hospital is practicing daily checkup towards patients within every 4hours manually. The time interval between the checkups can lead to emergency case as we cannot predict when the temperature to would suddenly rise. Besides, some of the present temperature monitors are not accurate due to less sensitive sensors used in temperature sensing.

1.3 Objective

The objective of this research is to design and develop an effective wireless temperature monitoring system that can be used in wider and longer range. The development is to improve the accuracy and efficiency in temperature sensing system. Developed monitoring system is to reduce manpower workload for continuous monitoring system. Thus, compare developed system with existing system in term of data transmission performance and distance travel.

1.4 Scope of Study

The scope of study will evolve around the development of a monitoring system for human body temperature. The studies will be conducted in three main parts:

1.4.1 Designing a device embedded with temperature sensor and data transmitter.

To study and test the best temperature sensor to be used in measuring human body temperature and then, sending the data to the receiver. Suggested temperature sensor is thermistor.

1.4.2 Developing a wireless network system as transmission medium.

To study the best wireless network system used for most effective data transmission in wide range and minimally affected by any obstacles. Suggested wireless transmission mediums are RFID, Zigbee and Wi-Fi network.

1.4.3 Designing a system for receiving data and display

To study and design a receiver device and convert the analog data into digital input and displays the data. Suitable programs need to be developed to read the data and display the reading on the screen.

CHAPTER 2

LITERATURE REVIEW

2.0 Introduction

As technology keeps improving and emerging in times will help world daily activities to be improved. Below, the author will be discussing on the temperature monitoring where current monitoring system needed to be improved as the technology is improving our life easier. Next, the author will also talking about two mainly used and the most preferable to be used in temperature monitoring systems.

2.1 Temperature Monitoring

Temperature is a measure of average heat in some space. In the other word temperature is how much thermal energy of the particles in some space and substance. Temperature is depending on the number of particles and size of the object as it is an average measurement. Body temperature is about measurement of average heat in a body. The body is naturally created to be very good in maintaining its safe range of temperature. Inner part of the body will keep comparing and reacting to the temperature difference between it and surrounding. The blood vessel under the skin will contract as a person in cold condition to reduce the blood flow to the skin in order to conserve heat and make the person shivering. While during hot situation, the blood vessel will expand to bring out excess heat through the skin's surface, thus cause the skin to start sweating.

In measuring the human body temperature, there are a few locations on the body to be considered. It includes mouth, ear, armpit and rectum. The most accurate part is the rectum. But nowadays temperature can be measure on the forehead using infrared thermometer. According to the 19th-century German physician, Dr. Carl Wunderlich; normal benchmark body temperature is 98.6°F or 36.9°C. He claimed this after collecting and analyzing over a million armpit temperature of 25,000 patients in hospital. While the research stated in [1]: the normal adult average temperature is 98.2°F not 98.6°F and temperature below 95°F (too low) is

considering illness. Human body temperature varies depend on activity, time of the day, and psychological factors [2].

Sund-Levander had conducted the largest systematic review of temperatures using data from studies published between 1935 and 1998. Findings of normal temperature means and ranges for males and females are summarized in Table 1. This comprehensive review of the literature indicates that actual observations, normal temperature occurs within a range of values and is dependent on the site monitored. Only seven of 37 data sets meeting inclusion criteria for accuracy and reliability reported average values of body temperature equal to or above 98.6° F / 37.0° C where six of these seven reported rectal temperature data. They also reported that after summarizing the available data from the different studies “... no mean value exceeded 37.0° C, irrespective of place of measurement.” After reviewing the literature, Sund-Levander reported a slightly wider range of 95.9-98.6° F/35.5-37.0 °C [3].

Table 2.1: Normal Temperature Means and Ranges from a systematic Review of the Literature Review (1935-1998) [3]

	Oral	Rectal	Tympanic	Axillary
Normal Body Temperature Mean and Range (males)	98.0° F (96.3-99.9) 36.7° C (35.7-37.7)	98.6° F (98.1-99.5) 37.0° C (36.7-37.5)	97.7° F (95.9-99.5) 36.5° C (35.5-37.5)	
Normal Body Temperature Mean and Range (females)	97.2° F (91.7-100.6) 36.2° C (33.2-38.1)	98.6° F (98.2-98.8°) 37.0° C (36.8-37.1)	37.0° C (36.8-37.1) 97.9° F (96.3-99.5)	
Normal Body Temperature Mean and Range (males and females combined)				97.3° F (95.9-98.6) 36.3° C (35.5-37.0)

In the year of 1869, Wunderlich had observed that body temperature increased with mental exertion, constipation, and urinary retention. He also observed slightly higher temperatures in women than in men and significantly lower (0.9° F/0.5 °C) temperatures in older individuals. Of considerable importance are Wunderlich’s observations that temperature oscillates in both healthy and unhealthy individuals according to the time of day. He had wrote, “The lowest point is reached in the morning hours between two and eight, and the highest in the afternoon between four and nine.” His published writings suggest an average change of 0.9°

F/0.5° C during this oscillation. While Wunderlich’s observations of a 98.6° F/37.0° C average temperature became the basis for a ‘normal’ temperature, his observations on normal temperature variation appear to have been essentially disregarded in clinical medicine [1].

2.2 Radio Frequency Identification (RFID)

Wireless is a telecommunication technology using electromagnetic waves that varies according to its frequencies. In wireless temperature monitoring, the most commonly technology used nowadays is Radio Frequency Identification (RFID). RFID can be divided into two categories active RFID and passive RFID. RFID consist of tags and reader [4]. The active tags required a source to power it up, while passive tags do not need any power source. Passive tag obtains energy from reader/writer [5].

Table 2.2: Type of RFID tag and its characteristics

Items	Passive RFID tag	Active RFID tag (Con.)	Active RFID tag (new)
Comm. Range	70cm/ 3m - 7m	more than 10m	around 10m
Battery life	(no battery)	around 1 year	around 1 year
Security	weak	N/A, or weak	strong
Cost	less than \$1	less than \$10	around \$10
Application	distribution/ inventory control of goods.	tracking person (restricted area)	tracking person (no restriction)

RFID communication system is a relation between two main elements which are transmitter and reader. RFID tag is functioning as the transmitter to send the data to the receiver to be processed [6].

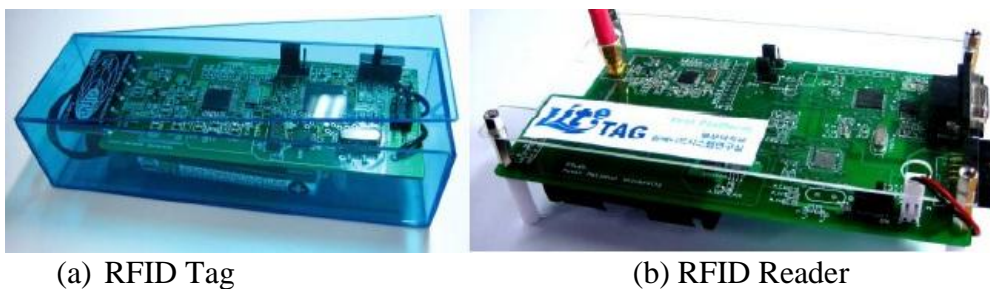

Figure 2.1: Diagram of RFID tag and reader [6]

Smart RFID tags are new development in RF tags which able to sense, monitor, and adapt to their changing environment. In the year of 2009, a research done in Finland had found that the Ultra High Frequency of RFID able to monitor external capacitive and resistive in pipeline Analogue to Digital Converter (ADC) [7].

In developing RFID communication, the improvement is the main data is flowing from many devices at edge of network towards central servers. In RFID network system, the sensors or RFID readers detect certain event and forward the information to the application on central server. The integration between smart sensor devices and networks is very important to make sure the communication is efficient [8].

There are three main classes of RFID reader and sensor devices. The first class is wired devices with no serious power constrains. Usually the device physically embedded with 32-bit microprocessor for local data processing. Second class is PDA like battery driven mobile devices as RFID readers and similar to first class but using wireless connection. Acceptable battery lifetimes are about 10,000 hours for the condition of extremely low duty cycles. The third class is very low power battery driven low performance sensor units. Battery lifetimes are about 10,000 to 15,000 hours for 0.1% duty cycles. The software architecture for this class is different compare to both first and second class, it need special software architecture for RFID network [8].

Active RFID tag is functioning as it receive signal at antenna and demodulated the signal into digital signal in a receiver (RX). As stated in Figure 2 below, a synchronizer (SYNC) detect wake up sequence in packet signal and synchronized it and move to smart buffer (SB) to be analyzed and extracting a command in protocol processor (PP). The tags then transmit return packet as response to received packet (wake-up call). A transmitter (TX) converts the digital signals to a radio frequency and signal radiated from antenna to the RFID receiver [9].

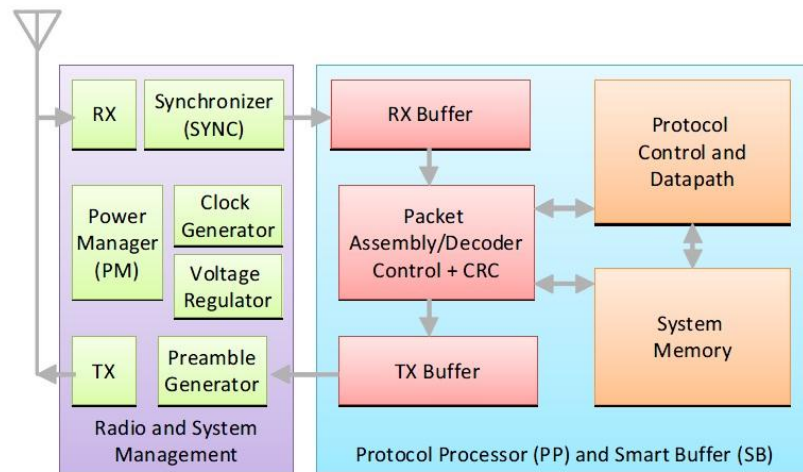

Figure 2.2: Block diagram of RFID tag

Besides, RFID tags have many approach of power generation to function the systems. In the year of 2011 with the development of semi active RFID tags, the tags are powering up by using piezoelectric power supply for temperature sensing. With the concept of piezoelectric energy harvesting from mechanical vibration of transducers used to functions semi active tags with embedded temperature sensing systems. Developed piezoelectric power supply can integrate with temperature sensing chip as well as humidity sensing systems [10].

As a result of using RFID technology in data communication systems, lead to a few implication for healthcare organizations. With the uses of theory of reasoned action and technology acceptance model (TAM) to empirically test a model with respect to adoption of RFID technology in healthcare organization. Predicted market increase of RFID technology will increase to more than \$2.1 billion by the year of 2016. The healthcare organization can get the benefits of RFID technology in tracking drug usage, condition of patients, nurse and medical supplies [11].

2.3 ZigBee Wireless Network

Zigbee wireless network is another emerging technology in wireless sensor network. The world nowadays is applying this network as the best wireless application in many sectors of life including health, agriculture, communication's broadcasting and so on. Zigbee wireless network is known to be very useful when embedded with sensors. Zigbee network topology can be divided into three type of network which are; star network, tree network and mesh network [12].

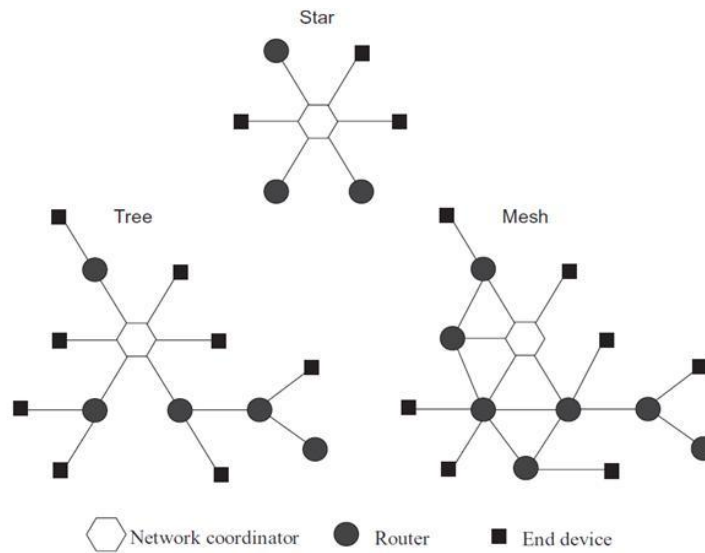

Figure 2.3: ZigBee Wireless Network Topology

Zigbee is a one of wireless networks that using IEEE 802.15.4 Protocol. It has a few advantages with low complexity, low power consumption with high reliability. Besides, this network also low in cost, and low transmitting rate and being capable for ad-hoc networks [13].

In the year of 2011, large active RFID system is utilizing the technology of ZigBee Network. By using operating 433 MHz frequency band, the interface of RFID is optimizing the topology of ZigBee network [14]. By using RFID tags with provided IDs can transmit to RFID readers with mesh network topology. This data transmission is very effective as it can travel to very long range of distance between the transmitters to receiver.

A research made in the year 2009 describing about the comparison between RFID wireless network and ZigBee wireless network. According to the research, both data transmission medium is very good medium but with a different advantages [13]. RFID has many advantages which can store more data up to 4MB, can communicate with multiple tags and reader, and can read several tags at the same time with high efficiency. While ZigBee network is very energy saving compare to RFID. Moreover, ZigBee has flexible scalability and high capacity network, fast responding and cheap cost of manufacturing. Although the transmission rate is quite low, but that rate is sufficient enough for industrial production and health monitoring [13].

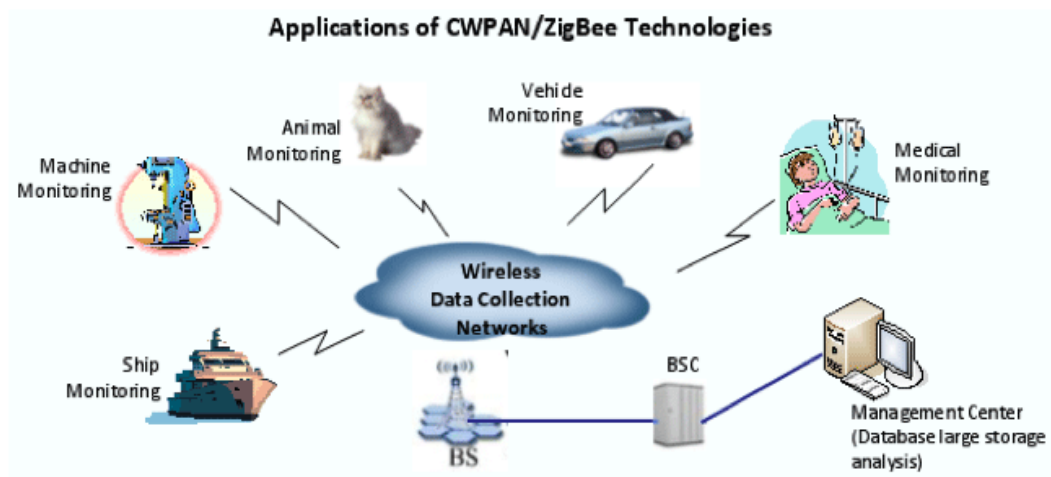
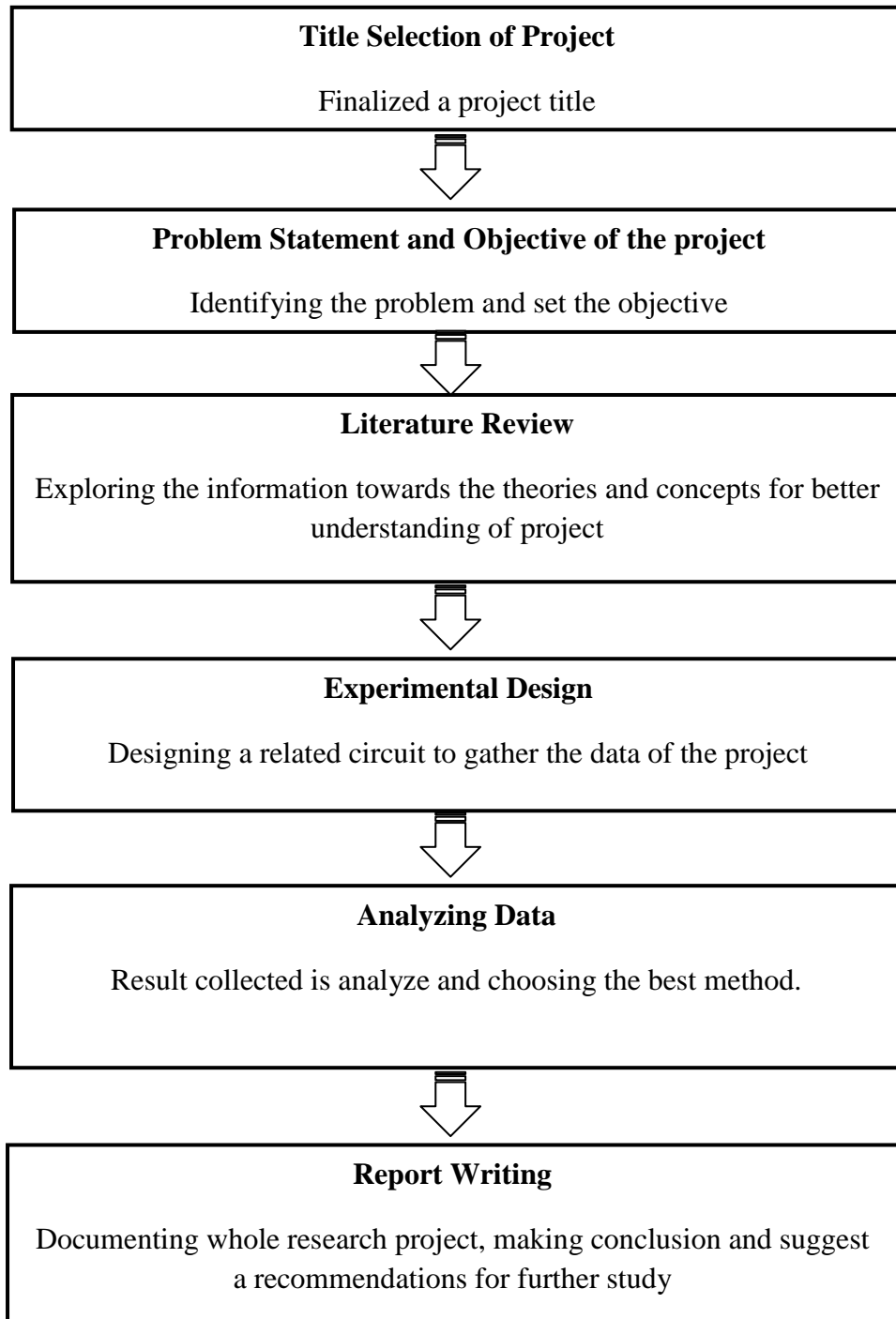

Figure 2.4: Function of RFID and ZigBee in monitoring system [15]

CHAPTER 3

METHODOLOGY

3.1 Research Methodology



3.2 Gantt Chart

No	DETAIL WEEK	1	2	3	4	5	6	7	Mid-term Break							8	9	10	11	12	13	14
1	Selection of Project Title	█	█																			
2	Research for Literature Review		█	█	█	█																
3	Submission of Extended Proposal						*															
4	Preparation for Proposal Defence								█													
5	Oral Proposal Defence Presentation													█								
6	Detailed Literature Review													█	█	█	█	█	█			
7	Preparation of Interim Report			█	█	█	█	█						█	█	█	█	█	█			
8	Submission of Interim Final Report																				*	

* Milestone

█ Activities

3.3 Tools and main element of project:

3.3.1 Thermometer

Temperature is usually measured by using a device called thermometer. Conventional thermometer is the mercury bulb thermometer whereby having mercury inside a bulb and the glass tube. When the heat reaches the bulb, causes the mercury to expand and rise up inside the tube and show the temperature reading.



Figure 3.1: Mercury Thermometer

Nowadays, there are many more sensors and technics used to measure the temperature. In having and electronic thermometer, we need to have electronic temperature sensor such as thermocouple, Resistance Temperature Detector (RTD), thermistor, Integrated Circuit (IC) sensor, and so on.

3.3.2 Thermistor

Thermistor is the most suitable sensor can be used as the electronics sensor to detect the temperature. The advantages of using thermistors are that they are low in cost, have fast response time and the accuracy is almost accurate. Thermistor is ceramic semiconductor that response to the heat. When it detects the heat from surrounding the value of its resistance will change. It has either large positive temperature coefficient (PTC) or negative temperature coefficient (NTC).



Figure 3.2: Types of NTC thermistors

3.3.3 Microcontroller

In this project, Arduino Uno will be used as microcontroller. Arduino Uno is a microcontroller board based on the ATmega328 chip. The chip is a high performance and low power 8-bit micro-controller that has 23 programmable I/O lines, 32K bytes of flash memory, 1k bytes of EEPROM and 2k bytes of RAM. Arduino board provides the user with 6 analog input pins, 14 digital I/O pins of which 6 of them can also be used for PWM outputs, power jack, and USB port.

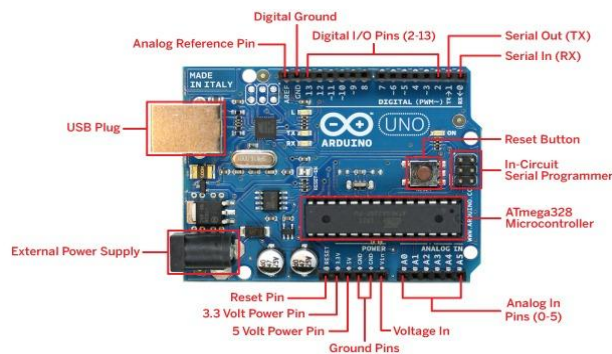

Figure 3.3: Arduino-UNO board as microcontroller [16]

3.3.4 System Architecture

The system hardware architecture is about combining all the system and application in order to perform this project's hardware design. The architecture begins from a few subject placed at specific location which each of the subject will be embedded with a Zigbee Xbee Pro transceiver module with the temperature sensor. Then, the data that collected will be transmitted to Zigbee SKXBEE as receiver. After the data received at receiver, the data will go through the Ethernet system route that author used. One of the routes is through the Wireless Area Network (WAN) which will be connected to the computer in control room and can trigger alert to mobile nurse available. Another route is where all the data is kept in the system database for future reference.

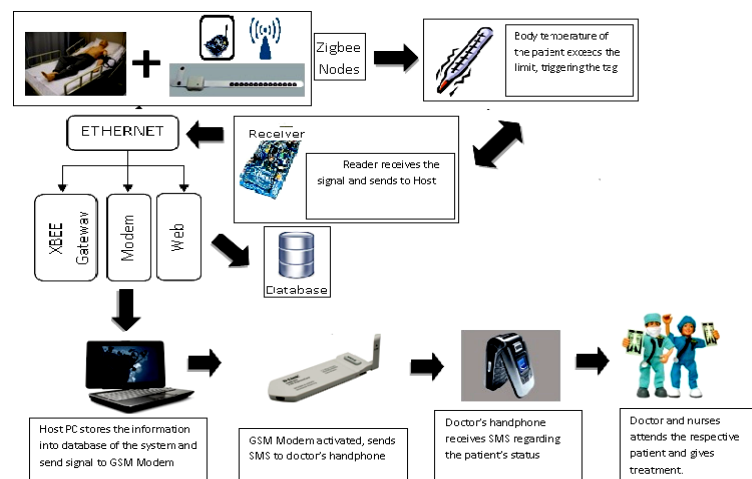

Figure 3.4: System Architecture

CHAPTER 4

RESULTS AND DISCUSSION

4.1 Project Design

The temperature sensor will be embedded to microcontroller and attached together with transmitter. Analog data from sensor will be converted by the microcontroller into digital signal and prepare to be transmitted by the transmitter. As the project is using Zigbee wireless network, the tag will be constantly powered by power source. Figure 8 and Figure 9 below is the proposed design of the temperature monitoring system and preliminary work of prototype.

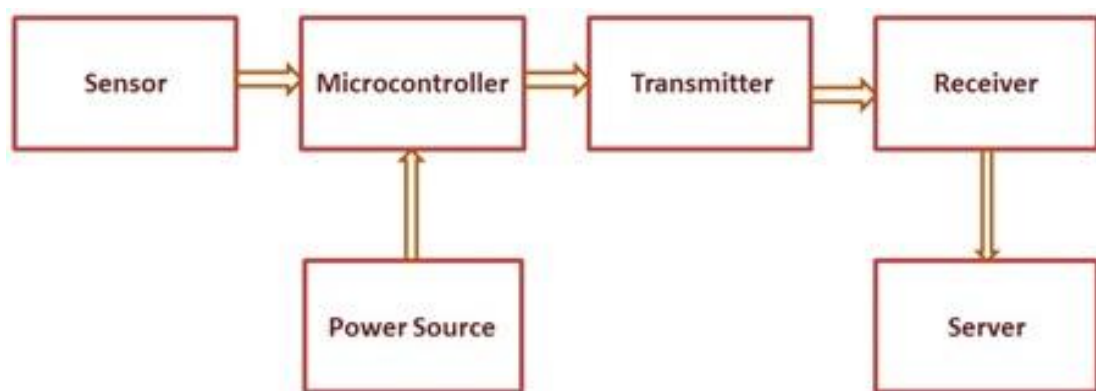

Figure 4.1: Proposed design of temperature monitoring system by using RFID

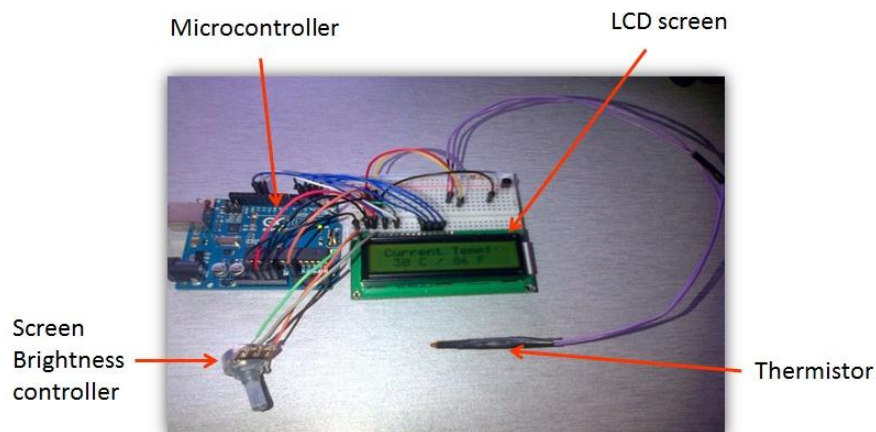

Figure 5: Preliminary design of temperature sensor prototype

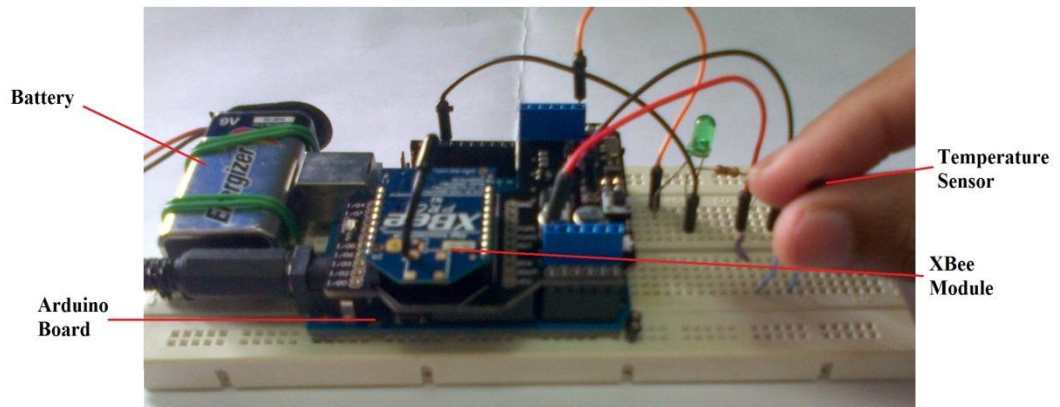

Figure 6: Project design using XBee Module (used Arduino Board)

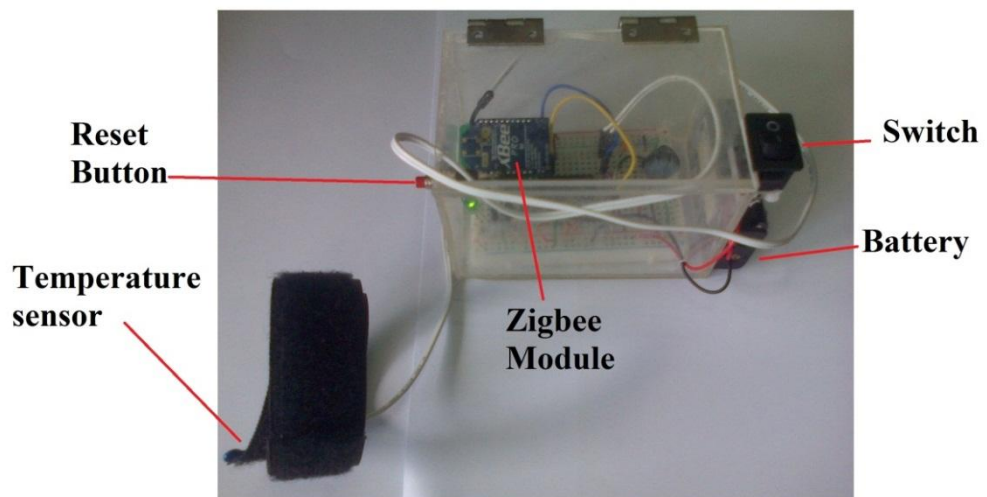

Figure 7: Design of Temperature Tag using XBee Module

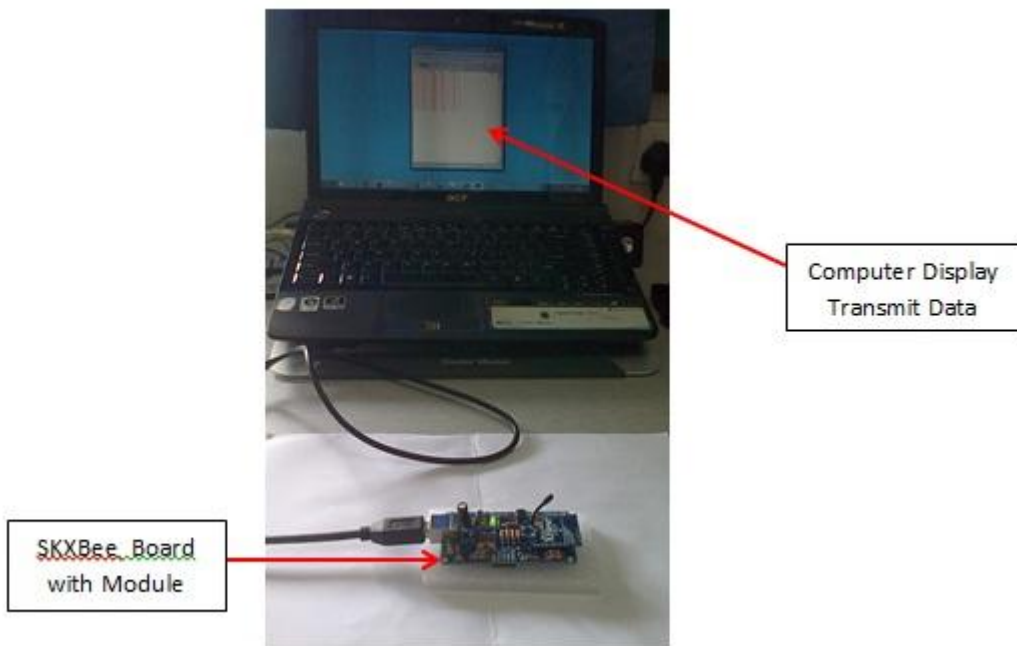

Figure 8: Design of XBee Receiver using SKXBee to Monitor

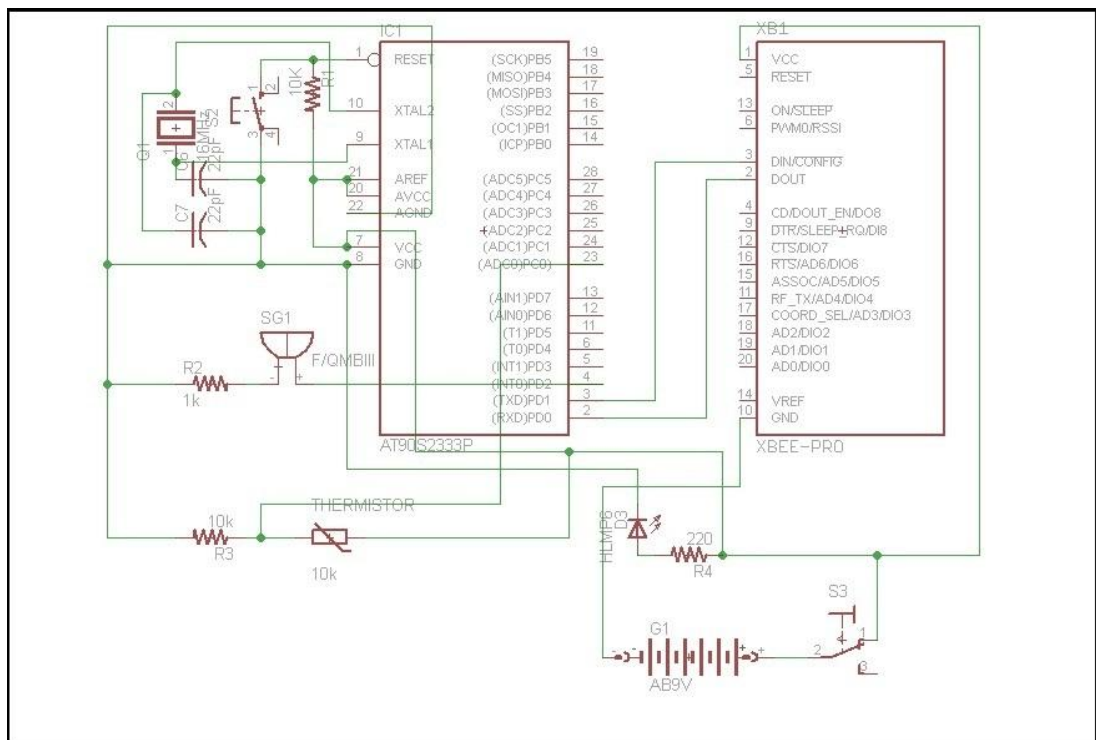

Figure 9: Schematic Circuit Diagram

4.2 Result

The designed prototype is tested in four parts:

4.2.1 Thermistor Comparison Test

First part is to determine the best thermistor for temperature sensing. According to the research made before, stated that thermistor is the best approach for measuring body temperature as it is fast response, highly accurate and cheap in price. The thermistors values are compared with the clinical body thermometer's temperature values as the reference for accuracy aspect. Table 3 below is the results showing the comparison of three thermistors selected as temperature sensing element.

Table 4.1: Temperature sensors (thermistors) comparison

Thermistor	Accuracy	Stability	Time Response	Price
A	Low	Low	5s	RM3
B	High	Most Stable	2s	RM12
C	High	Stable	6s	RM6

4.2.2 Location Sensing Test

Second part is to detect the accuracy of its temperature sensing at specific body location. The prototype's values are comparing with the clinical body thermometer's temperature values as the reference of accuracy. Table 4 below is the results showing the comparison regarding human body location in getting the accurate body temperature.

Table 3.2: Results of temperature values

No	Body Part	Measured Temperature (C)	Thermometer Temperature (C)
1	Left Fingertip A	34	34
2	Left Fingertip B	34	35
3	Right Fingertip A	34	34
4	Right Fingertip B	34	34
5	Mouth A	36	37
6	Mouth B	36	36
7	Armpit A	35	36
8	Armpit B	36	36

4.2.3 Temperature Sensing Device Accuracy Test

The third experimentation is to measure the accuracy of the designed temperature sensor device by using the thermistor and to compare to the reading after being transmitted through Zigbee medium and compare with the reading of clinical thermometer. The signal of data will be transmitted through ZigBee communication network and according to the result show below that the reading is the same as reading before data is transmitted. Table 4.3 is one of the reading obtain from the accuracy test. The temperature sensor is located at the arm-pit of every subject and the author had taken 4 respondents as subjects in proving the accuracy of the temperature monitoring system designed in table below:

Table 4.3: Temperature reading of accuracy test

Time (s)	Temperature Reading (°C)		
	Direct	Zigbee	Thermometer
1	7.17	7.17	35.7
2	12.93	12.93	35.7
3	13.02	13.02	35.7
4	18.57	18.57	35.8
5	24.11	24.11	35.8
6	29.8	29.8	35.8
7	35.84	35.84	35.8
8	35.84	35.84	35.8
9	35.84	35.84	35.8
10	35.84	35.84	35.8
11	35.84	35.84	35.8
12	35.84	35.84	35.8
13	35.84	35.84	35.8
14	35.84	35.84	35.8
15	35.84	35.84	35.8
16	35.84	35.84	35.8
17	35.84	35.84	35.8
18	35.84	35.84	35.8
19	35.95	35.95	35.8
20	35.95	35.95	35.9
21	35.95	35.95	35.9
22	35.95	35.95	35.9
23	35.95	35.95	35.9
24	35.95	35.95	35.9
25	35.95	35.95	35.9
26	35.95	35.95	35.9

4.2.4 Distance Transmission Test

While in the fourth experimentation is to measure the efficiency of transmitted data through ZigBee network. Since the author had determined the best medium of transmission is by using ZigBee wireless network, the test is done in a few different atmospheric conditions. The temperature tag prototype transmits the data of temperature detection to the receiver. The receiver then converts the digital data and displays it on monitor by using XCTU software. Table 4.4 below is the three atmospheric conditions tested during the data transmission.

Table 4.4: Different environments of data transmission range test

Environment	Atmospheric Condition
1	Line of Sight
2	Indoor (air-cond)
3	Indoor (room)

4.2.5 Data Interference Test

Last but not least the fifth test is to check if there is any interference of data when many ZigBee tags (transmitters) are transmitting the signal to a single ZigBee receiver. During this test, the author had made up 3 identical prototypes as the tags for the temperature sensing devices. All the devices are labeled Tag A, Tag B and Tag C.

Figure 10: Three identical tags transmit to single receiver.

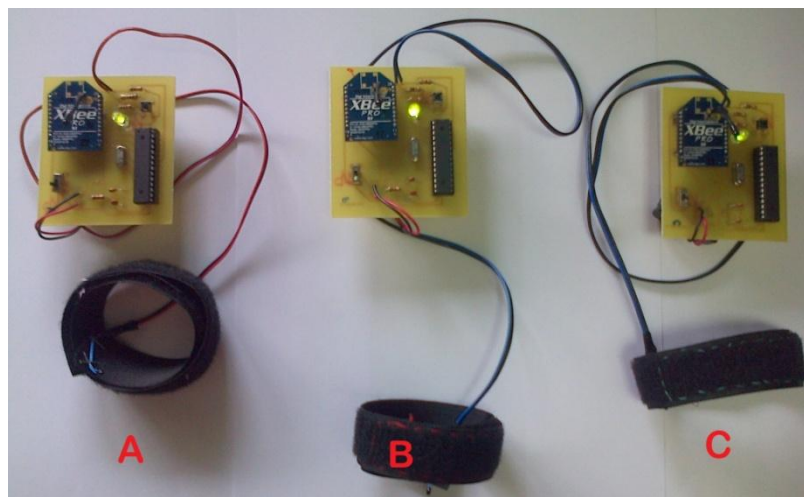

4.3 Discussion

After some research regarding the different type of temperature sensors, the author had chosen thermistor as the temperature sensor for the prototype. Table below is describing the comparison on different temperature sensors.

Table 4.5: Comparison if different temperature sensors [2]

Type of Sensors	Thermistor	RTD	Thermocouple	I.C
Advantages	High accurate output, Inexpensive and fast response	Most accurate, most stable and more linear than thermocouple	Self-powered, inexpensive, simple and wide variety of physical forms and wide temperature range	Most linear, inexpensive and highly output
Disadvantages	limited temperature range, non-linear, self-heating and fragile	Expensive, need current source, slow response	Low voltage, non-linear, least stable and least sensitive	need power supply, over 250°C, slow response and limited configuration

As human body temperature range is below 100°C, so the IC and thermocouple sensor will not be consider by author. While both RTD and thermistor is suitable for human body temperature and having high accuracy and stability but RTD is much expensive and having slow response [2].

Based on the result at Table 4.1 above shows about the 3 thermistors is selected to be test in order to find the best temperature sensor for the prototype. All those three thermistors are labeled as Thermistor A, B and C. all of them were tested in a few aspects such as accuracy, stability, response and also the cost. All the results obtain from Table 4.1 is indicating the graph of accuracy of each of the thermistor used. Three tests were taken for each of thermistor during this test.

All the results then were compared in graphical form and the best data will be chosen as the best temperature sensor. Figure 15, 16 and 17 below indicate the graph of those three thermistors tested.

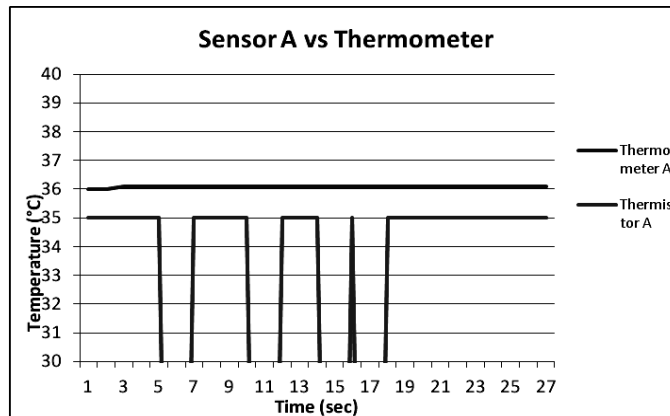

Figure 11: Reading Comparison between Thermistor A and Thermometer

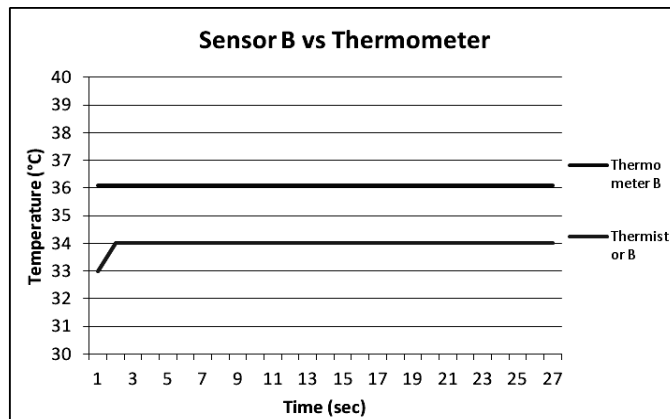

Figure 12: Reading Comparison between Thermistor B and Thermometer

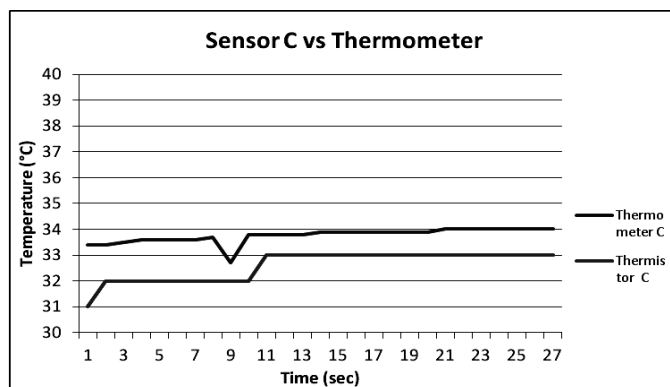

Figure 13: Reading Comparison between Thermistor C and Thermometer

Based on the graphical result obtain above, we can see that all the thermistors tested in normal room temperature with different stability of the readings. In Figure 4.8, the reading is unstable and inaccurate as the reading is fluctuates at certain point until the reading reach 0 °C and suddenly can move to peak reading again. The average error counted was 6 °C. While for Figure 4.9 show that the reading is stable and follow the graph of the thermometer reading. The average error counted was 2.1 °C difference. This one is better than Thermistor A before.

Figure 4.10 indicates the reading of Thermistor C where the graph obtains showing a delay in obtaining the reading. And the reading is suddenly drop after 9s of temperature detection and continues to detect the same value of temperature. Based on all the graph and data obtain as in Table 4.1, the author had chosen Thermistor B as the best temperature sensor. This is due to the high accuracy, the most stable reading and fastest time response. Although the price of Thermistor B is quite expensive; but it is still in budget of project.

According to the result obtain from the test made; the temperature value measured by using prototype is slightly different compare to the measured value by using the clinical thermometer. This show that the temperature sensor used is good by having almost accurate value compare to the clinical thermometer used. The temperature sensor, which is thermistor, is the best sensor to measure the body temperature as it has high sensitivity and less error. The value is not really accurate is might be because of the space and location of the temperature taken at specified part of the body.

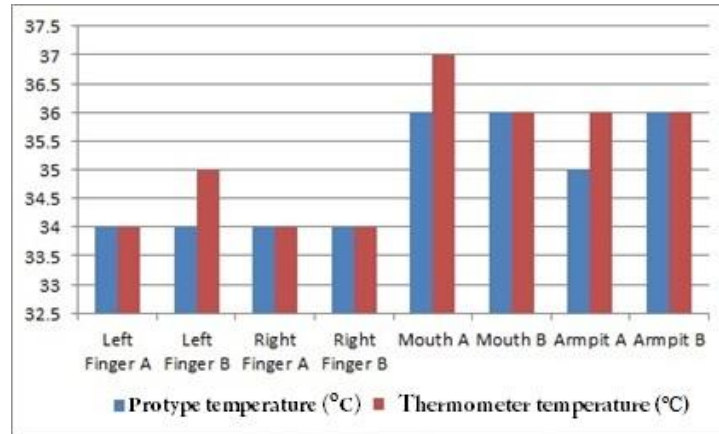

Figure 14: Temperature analysis based on part of body

The temperature is taken from 2 person of about the same age with different gender. Person A is male and Person B is female. According to the value obtains, the temperature value of male and temperature value of female tester is almost the same. Although with different gender but the value is almost same might be because of the age and body size factors, where both person A and B have the same ages and slightly have the same weights.

Based on the temperature value in the table above, the most preferable locations to take the accurate body temperature are in mouth and armpit. It shows the most accurate to the theoretical value of body temperature which is around 37 °C. Compared to the value taken at fingers is 2 °C to 3 °C different from the theoretical body temperature.

During the accuracy test, the author had chosen 4 respondents of the same age group and same gender. All the respondents are in 23 years old and all of them are male. Each respondent will have to perform accuracy test for 3 trials. As stated before, all the sensor of temperature is placed at the arm-pit of every respondent, so that the comparison will be valid on the same location of human body. All the figures below are the graph of representing the best reading of every respondent in measuring the accuracy of the temperature sensor.



Figure 15: Temperature Reading of Direct Method

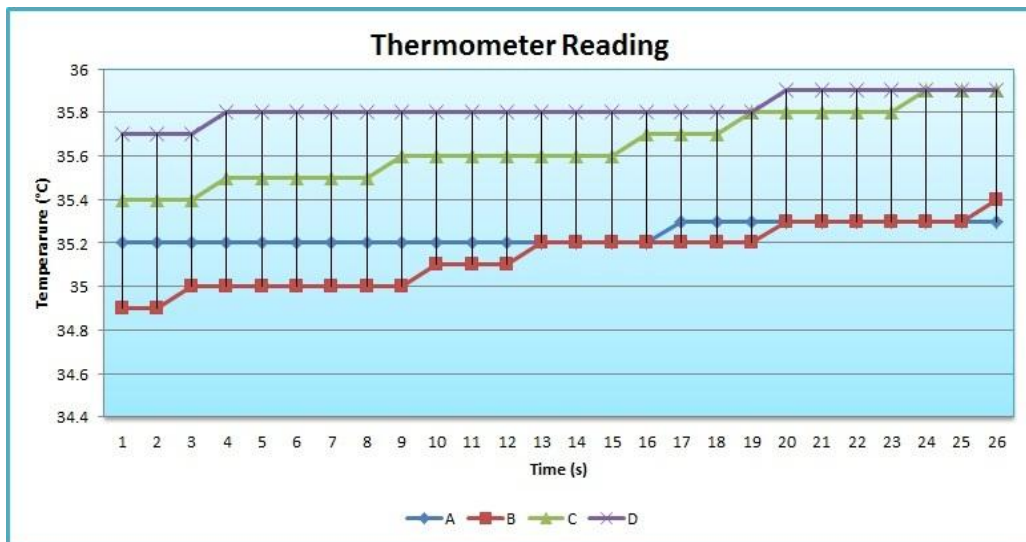

Figure 16: Temperature reading of using Thermometer

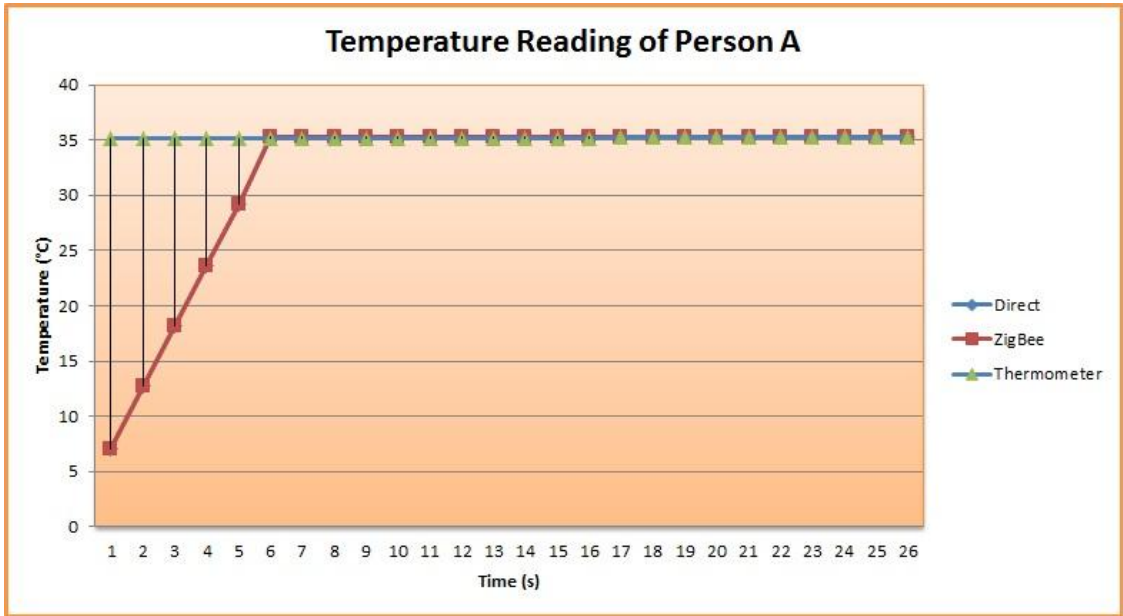

Figure 17: Temperature Reading of Subject A

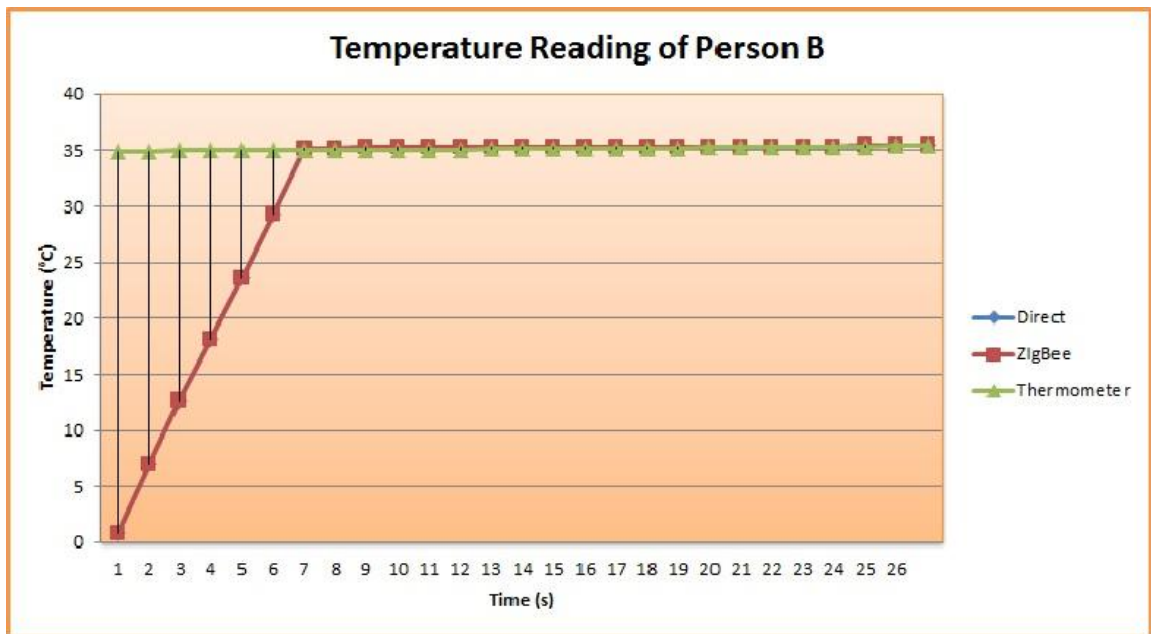

Figure 18: Temperature Reading of Subject B

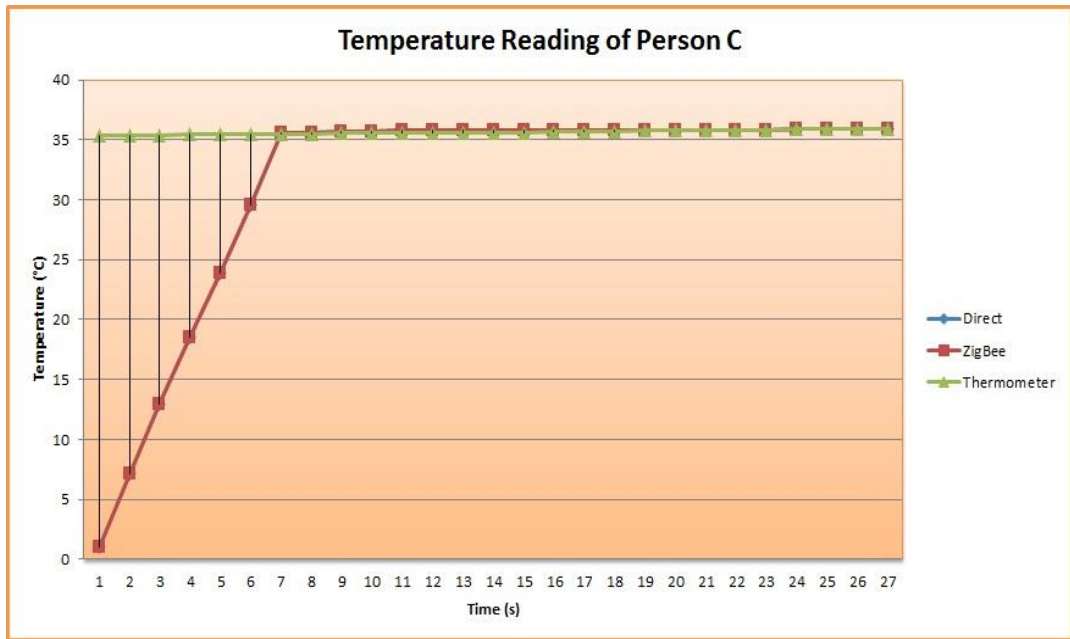

Figure 19: Temperature Reading of Subject C

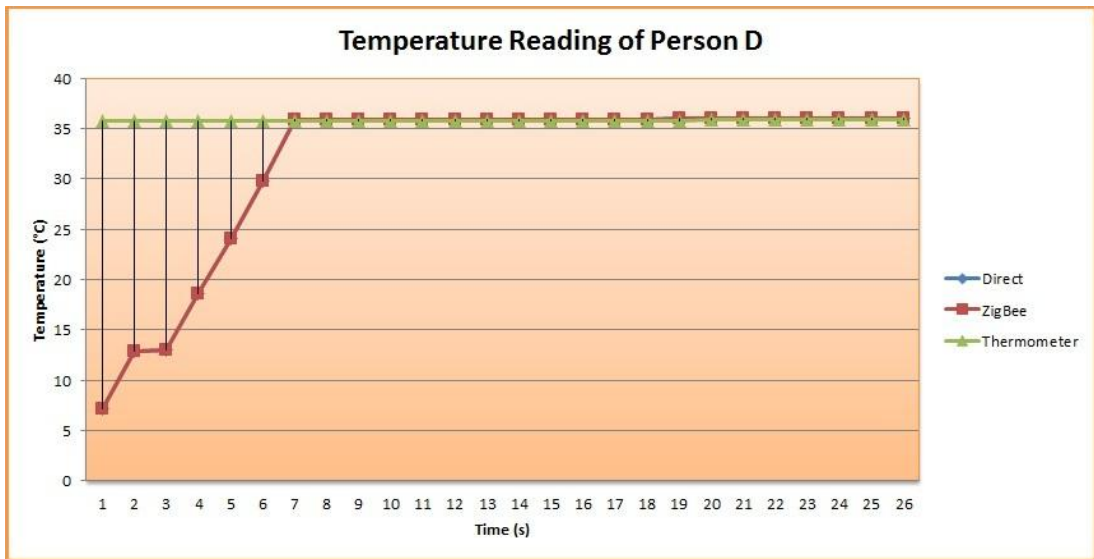

Figure 20: Temperature Reading of Subject D

Figure 4.12 graphical data is obtained from subject A, subject B, subject C and subject D through direct method. Direct method is where the design temperature monitoring system is placed on the subject without transmitting it through ZigBee communication network. This data collection is made as a benchmark for other further comparison analysis. From the figure subject A provides excellent and most stable reading while subject B, C and D average reading. The reading is starting from below because of the delay time of the thermistor to take the temperature reading of subject before it then stabilizes and reaches excellent reading. The difference maybe due to internal factors such as stress, tired or food consumption of each individuals.

Figure 4.13 graphical data is also obtained from subject A, subject B, subject C and subject D but by using the clinical thermometer. The location of the reading is taken is the same location and put together with the thermistor (designed temperature sensor). From the figure, subject D is seem to be the most excellent and stable reading while subject C and D are average and subject B is lowest reading of human body temperature. The difference maybe due to internal factors such as stress, tired or food consumption of each individuals and also because of the position of the thermometer at arm-pit is defferent at different subject.

Figure 4.14, Figure 4.15, Figure 4.16, and Figure 4.17 shows the data comparison between direct approach, through Zigbee wireless network and direct clinical thermometer reading for subject A, B and C. From the figures show that the reading of direct method and reading of transmit through Zigbee wireless network is totally the same. This situation indicates that the data from thermistor is send through Zigbee excelently without any error or distruction of data. This is proving that decision of choosing Zigbee wireless network as transmitting medium is exact decision.

Table 4.6: The Accuracy Test of different subjects

	Average Thermistor	Average Thermometer	Error
A	35.258	35.248	0.007
B	35.289	35.195	0.267
C	35.781	35.700	0.225
D	35.884	35.835	0.137

Apart of that, the figures also describe the Zigbee approach provides stable reading in terms of temperature on comparing to the reading from clinical thermometer. From the Table 4.6 above, the errors is count starting from the stabilize reading of different subject and by calculating the average reading of thermistor and thermometer reading. Both readings is compared and come out the errors ot accuracy test. Among all the subjects subject A is the best curve of proving the temperature reading from the thermistor is approaching the clinical thermometer reading and have the lowest error compare to other subject. By comparing of the errors also prove that subject A is the best curve with 0.007% compared to subject B with 0.267%, subject C with 0.225% and subject D with error of 0.137%.

During the data transmission range test, the author had chosen 3 different atmospheric conditions. Based on Table 4.4, all those environmental condition are outdoor (line of sight), indoor (room temperature) and indoor with air conditioner. All the figures below are the graphs of representing the reading obtain regarding the range of Zigbee transmission in respective conditions.

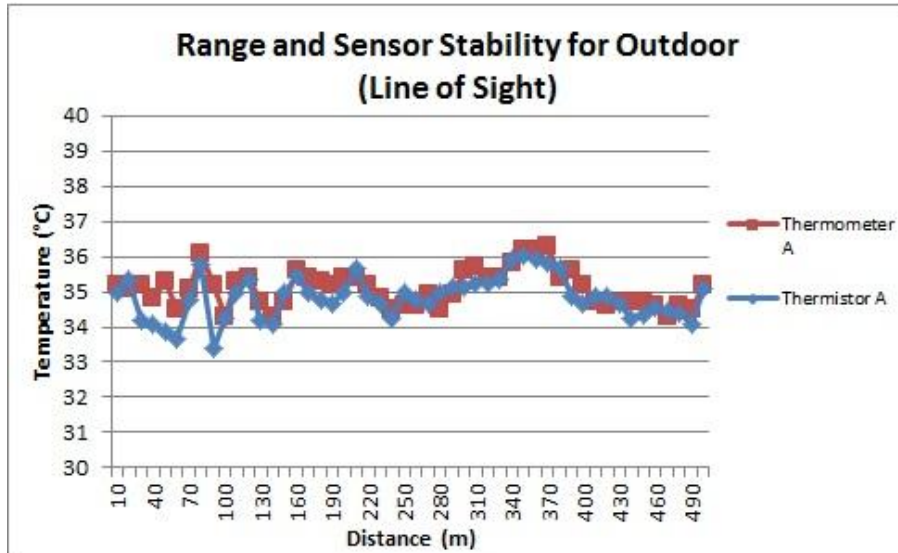

Figure 21: Range and stability measurement of sensor in outdoor environment

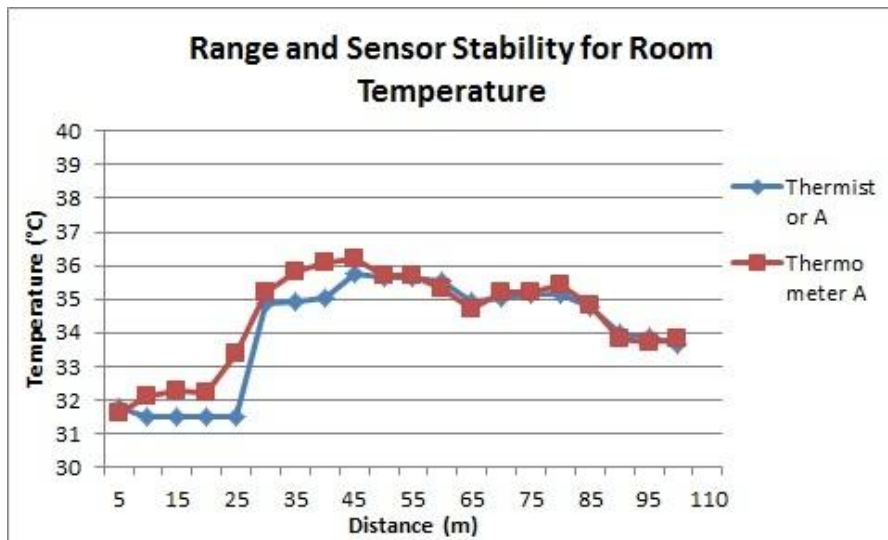

Figure 22: Range and stability measurement of sensor in indoor (room temperature) environment

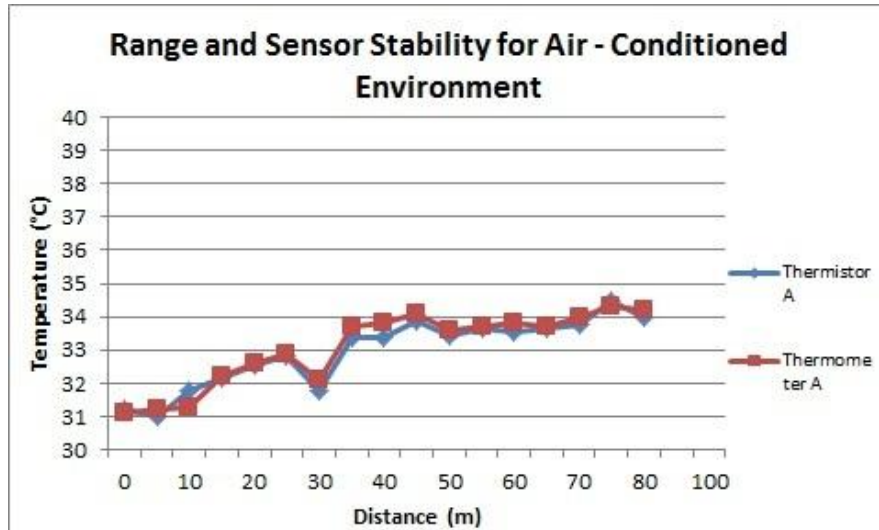

Figure 23: Range and stability measurement of sensor in indoor (air-conditioned) environment

Table 4.7: Range and stability in different environmental conditions

Type of Environment	Distance
Line of Sight	500 m
Indoor (air-cond)	80 m
Indoor (room)	100 m

From the Table 4.7 above, line of sight produced the longest range proving the maximum range Zigbee wireless transmission can be. In figure 4.18, it is found that the transmission can travel more than 500 meters. The reading also in stable as the transmission did not have any disruption from surrounding. While the increment of reading is due to increment of body temperature when moving.

Next, the testing is done in room temperature where the range is between 25 °C up to 34 °C and can varies due to weather change. As stated in Figure 4.19 the transmission in room temperature can be till 100 meters long. While in Figure 4.20 shows the reading in air-conditioned room, data can be transmit only up to 80 meters. This indicates that the environment also plays a role in human body core temperature. Thus, from all the data above are very important as most of the hospitals nowadays in Malaysia is equipped with air-conditioning systems.

While in the last test, the author had done the test about the data interference of signal transmitted to single receiver. Based on the figure 4.21 below, screen from software of X-CTU displayed 3 different data from each of the 3 different ZigBee tags. All the labelled tags A, B and C is transmitting well to the single ZigBee receiver through the same ID address of the transmission. This is proving that the data transmission from many tags to single receiver is good without any interruption or interference between each other.

Figure 24

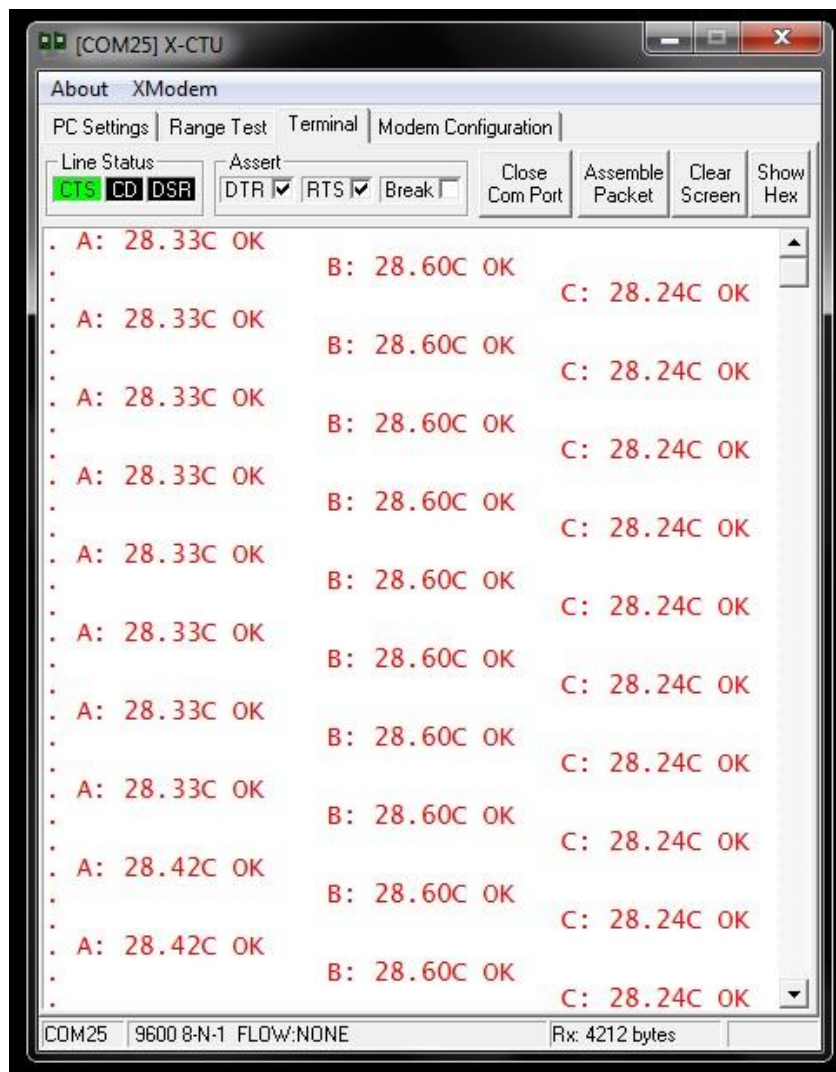

CHAPTER 5

CONCLUSION AND RECOMMENDATION

5.1 Conclusion

As a conclusion, designing a wireless temperature monitoring can be done by using Zigbee Wireless communication network. The design and implementation of the Zigbee concept can be achieve by using their hardware component and software component to get the temperature value and display readings.

5.2 Recommendation

For the betterment of the research regarding wireless temperature monitoring, the author would like to focus on the improvement of data communication range and temperature detection accuracy. Thus, recommendation can be made in the future is by using other advance wireless network during the futures.

REFERENCES

- [1] W. KRA, "The Course of Temperature in Disease," *Am J Medical Science*, vol. 57, pp. 425-447, 1869.
- [2] D. Parekh, "Designing Heart Rate, Blood Pressure and Body Temperature Sensors for Mobile On-Call System," p. 47, 2010.
- [3] L. M. Sund , C. Forsberg and L. Wahren , "Normal Oral, Rectal, Tympanic and Axillary Body Temperature in Adult Men and Women," *Scand J Caring Science* , vol. 16, pp. 122-128, 2002.
- [4] R. Want, "An Introduction to RFID technology," *RFID Technology*, vol. 1, pp. 1-9, January - March 2006.
- [5] I. Yamada, S. Shiotsu , A. Itasaki and S. Inano, "Secure Active RFID Tag System," p. 5, 2005.
- [6] D. Pardo , "Design Criteria for Full assive Long Range UHF RFID Sensor fo Human Body Temperature Monitoring," p. 8, 2007.
- [7] Nadine , Pesonan; Kaarle, Jaakkola; Jerome , Lamy; Kaj, Nummila; Jouko, Marjonon, "Smart RFID Tags," in *Development and Implementation of RFID technology*, Finland, I-Tech, 2009, p. 554.
- [8] R. Clauberg, "RFID and Sensor Networks," in *RFID Workshop*, Switzerland, Sept 27, 2004.
- [9] Kenichi Agawa, Massimo Alioto, Wenting Zhou, Tsung Te Liu, Louis Alorcon, Kimiya Hajkazemshirazi, Mervin John, Jesse Richmong, Wen Li and Jan Rabaey, "Design and Verification of an Ultra Low Power Active RFID Tag with Multiple Power Domains," in *SASIMI Proceeding*, California, USA, 2010.
- [10] Hequn Chu, Guangmin Wu and Jianming Chen, "Study of Simulation of Semi-Active RFID Tags using Piezoelectric Power Supply for Mobile Process Temperature Sensing," in *2011 IEEE International Conference on Cyber Technology in Automation, Control and Intelligent Systems*, Kunming, China, March 20-23, 2011.
- [11] Amelia S.carr, Man Zhang, Inge Klopping and Hokey Min, "RFID Technology : Implication for Healthcare Organization," *American Journal Business*, vol. 25, no. 2, pp. 25-40, 2010.
- [12] N. Watthanawisuth, T. Lomas, A. Wisitsoraat and A. Tuantranot, "Wireless Wearable Pulse Oximeter for Health Monitoring using ZigBee Wireless Sensor Network," Pathumthani, Thailand, 2010.

- [13] Qiang Ruan, Wengsheng Xu and Gaoxiang Wang, "RFID and ZigBee Based Manufacturing Monitoring System," Beijing, China, 2009.
- [14] H. Cho and Y. Baek, "Design and Implementation of an Active RFID System Platform," in *International Symposium on Applications and the Internet Workshops*, 2005.
- [15] astri, "astri.org/main," 2000. [Online]. Available: http://www.astri.org/main/?contentnamespace=technologies:ct:rfic:dual_cwpan. [Accessed 21 March 2013].
- [16] Arduino, July 2013. [Online]. Available: <http://arduino.cc/en/Main/arduinoBoardUno>.
- [17] M. Takahashi, T. Nakajima, K. Saito and K. Ito, *Characteristic of Wristband Type RFID Antenna*, p. 4.
- [18] N. Pesonen, K. Jaakkola, J. Lamy, K. Nummila and J. Marjonen, "Smart RFID Tags," VVT Technical Research centre of Finland, Finland.
- [19] "How Does The Heart Beat," [Online]. Available: <http://my.clevelandclinic.org/heart/heart-blood-vessels/how-does-heart-beat.aspx>. [Accessed 17 February 2013].
- [20] "Heart Rate Measurement From Fingertip," 5 February 2011. [Online]. Available: <http://embedded-lab.com/blog/?p=1671>. [Accessed 18 February 2013].
- [21] S. M, I. Soujeri, R. Rajan and H. A I, "Design of a ZIGBEE-Based RFID Network for Industry".
- [22] S. H. Cheng, J. C. Huang and C. J. Lin, "A Real Time Location and Infant Monitoring System Based On Active RFID," in *International Conference on Machine Learning and Cybernetics*, Xian, 2012.
- [23] R. S. Sangwan, R. G. Qiu and D. Jensen, "Using RFID Tags for Tracking Patients, Charts and Medical Equipment within an Integrated Health Delivery Network," in *Networking, Sensing and Control*, 2005.
- [24] Q. Meng and J. Jin, "Design of Low-Power Active RFID Tag in UHF Band," in *Control, Automation and Systems Engineering (CASE) International Conference*, 2011.
- [25] J. Hightower, C. Vakili, B. G. and W. R., "Design and Calibration of the SpotON Ad-Hoc Location Sensing System," 2001.
- [26] L. M. Ni, Y. Liu and Y. C. Lau, "LANDMARC: Indoor Location Sensing Using Active RFID," in *Pervasive Computing and Communications*, 2003.

APPENDICES

APPENDIX A

THERMISTOR DATASHEET

**Temperature Measurement
Miniature Sensors**

**B57861
S 861**

Applications

- Heating systems
- Industrial electronics
- Automotive electronics

Features

- Fast response
- High measuring accuracy
- Different tolerances available
- Epoxy resin encapsulation
- PTFE-insulated leads of silver plated nickel wire, AWG 30

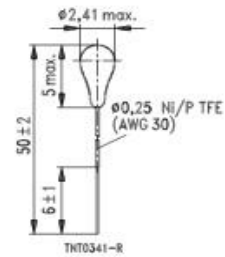

Options

Non-standard lead lengths

Dimensions in mm
Approx. weight 60 mg

Climatic category (IEC 68-1)		55/155/56	
Max. power at 25 °C	P_{25}	60	mW
Resistance tolerance	$\Delta R/R_N$	$\pm 1\%$, $\pm 3\%$, $\pm 5\%$	
Rated temperature	T_N	25	°C
B value tolerance	$\Delta B/B$	$\pm 1\%$	
Dissipation factor (in air)	δ_{th}	approx. 1,5	mW/K
Thermal cooling time constant (in air)	τ_c	approx. 15	s
Heat capacity	C_{th}	approx. 22,5	mJ/K

Type	R_{25} Ω	No. of R/T characteristic	$B_{25/100}$ K	Ordering code
S 861/2 k/+ 40	2 k	1008	3560	B57861-S202-+40
S 861/3 k/+ 40	3 k	8016	3988	B57861-S302-+40
S 861/5 k/+ 40	5 k	8016	3988	B57861-S502-+40
S 861/10 k/+ 40	10 k	8016	3988	B57861-S103-+40
S 861/30 k/+ 40	30 k	8018	3964	B57861-S303-+40
S 861/50 k/+ 40	50 k	2901	3760	B57861-S503-+40
S 861/100 k/+ 40	100 k	2014	4540	B57861-S104-+40

+ : F for $\Delta R/R_N = \pm 1\%$
 H for $\Delta R/R_N = \pm 3\%$
 J for $\Delta R/R_N = \pm 5\%$

Reliability data

Test	Standard	Test conditions	$\Delta R_{25}/R_{25}$ (typical)	Remarks
Storage in dry heat	IEC 60068-2-2	Storage at upper category temperature T: 155 °C t: 1000 h	$< 1\%$, $< 2\%^{1)}$	No visible damage
Storage in damp heat, steady state	IEC 60068-2-3	Temperature of air: 40 °C Relative humidity of air: 93 % Duration: 56 days	$< 1\%$	No visible damage
Rapid temperature cycling	IEC 60068-2-14	Lower test temperature: - 55 °C Upper test temperature: 155 °C Number of cycles: 10	$< 0,5\%$	No visible damage
Long-term stability (empirical value)		Temperature: + 70 °C Duration: 10 000 h	$< 2\%$	No visible damage

Figure 7.1: Thermistor datasheet

APPENDIX B

MICROCONTROLLER CHIP ATMEGA 328

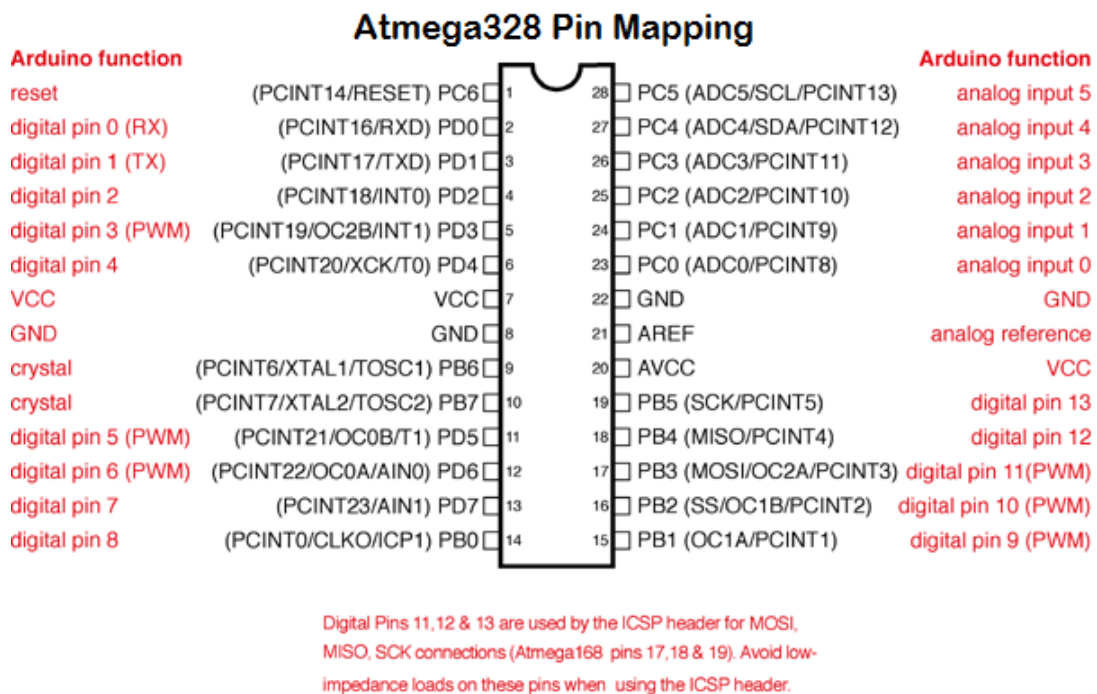

Figure 25: Atmega 328 Pin Mapping

APPENDIX C

ATMEGA 328P DATASHEET

Features

- High Performance, Low Power AVR[®] 8-Bit Microcontroller
- Advanced RISC Architecture
 - 131 Powerful Instructions – Most Single Clock Cycle Execution
 - 32 x 8 General Purpose Working Registers
 - Fully Static Operation
 - Up to 20 MIPS Throughput at 20 MHz
 - On-chip 2-cycle Multiplier
- High Endurance Non-volatile Memory Segments
 - 4/8/16/32K Bytes of In-System Self-Programmable Flash program memory (ATmega48PA/88PA/168PA/328P)
 - 256/512/512/1K Bytes EEPROM (ATmega48PA/88PA/168PA/328P)
 - 512/1K/1K/2K Bytes Internal SRAM (ATmega48PA/88PA/168PA/328P)
 - Write/Erase Cycles: 10,000 Flash/100,000 EEPROM
 - Data retention: 20 years at 85°C/100 years at 25°C⁽¹⁾
 - Optional Boot Code Section with Independent Lock Bits
 - In-System Programming by On-chip Boot Program
 - True Read-While-Write Operation
 - Programming Lock for Software Security
- Peripheral Features
 - Two 8-bit Timer/Counters with Separate Prescaler and Compare Mode
 - One 16-bit Timer/Counter with Separate Prescaler, Compare Mode, and Capture Mode
 - Real Time Counter with Separate Oscillator
 - Six PWM Channels
 - 8-channel 10-bit ADC in TQFP and QFN/MLF package
 - Temperature Measurement
 - 6-channel 10-bit ADC in PDIP Package
 - Temperature Measurement
 - Programmable Serial USART
 - Master/Slave SPI Serial Interface
 - Byte-oriented 2-wire Serial Interface (Philips I²C compatible)
 - Programmable Watchdog Timer with Separate On-chip Oscillator
 - On-chip Analog Comparator
 - Interrupt and Wake-up on Pin Change
- Special Microcontroller Features
 - Power-on Reset and Programmable Brown-out Detection
 - Internal Calibrated Oscillator
 - External and Internal Interrupt Sources
 - Six Sleep Modes: Idle, ADC Noise Reduction, Power-save, Power-down, Standby, and Extended Standby
- I/O and Packages
 - 23 Programmable I/O Lines
 - 28-pin PDIP, 32-lead TQFP, 28-pad QFN/MLF and 32-pad QFN/MLF
- Operating Voltage:
 - 1.8 - 5.5V for ATmega48PA/88PA/168PA/328P
- Temperature Range:
 - -40°C to 85°C
- Speed Grade:
 - 0 - 20 MHz @ 1.8 - 5.5V
- Low Power Consumption at 1 MHz, 1.8V, 25°C for ATmega48PA/88PA/168PA/328P:
 - Active Mode: 0.2 mA
 - Power-down Mode: 0.1 µA
 - Power-save Mode: 0.75 µA (Including 32 kHz RTC)



**8-bit AVR[®]
Microcontroller
with 4/8/16/32K
Bytes In-System
Programmable
Flash**

**ATmega48PA
ATmega88PA
ATmega168PA
ATmega328P**

Summary

Figure 26: Atmega328P Datasheet

APPENDIX D

CRYSTAL DATASHEET (16MHz)

- Low-cost, industry-standard crystal unit
- AT-Cut strip crystal with hermetically sealed can
- Frequency range 1.0MHz to 70MHz
- Package height options available



DESCRIPTION

HC49-4H crystals share the same base outline as the industry-standard HC49 crystal. The crystal uses an AT-cut strip crystal with an hermetically sealed can. HC49-4H crystals provide a low cost source of system clock frequency.

SPECIFICATION

Frequency Range:	3.2MHz to 70.0MHz
Oscillation Mode	
AT-Cut Fundamental:	3.2MHz to 30.0MHz
BT-Cut Fundamental:	24.0MHz to 48.0MHz
AT-Cut 3rd Overtone:	27.0MHz to 70.0MHz
Calibration Tolerance at 25°C	
AT-Cut:	±30ppm (tolerance to ±10ppm is available.)
BT-Cut:	±30ppm
Frequency Stability	
AT-Cut:	±30ppm over -10° to +60°C (Stability to ±10ppm is available)
BT-Cut:	±100ppm over -10 to +60°C
Load Capacitance (CL):	Series or from 8pF to 32pF
Ageing at 25°C:	±3ppm maximum, 1st year, ±1ppm per year thereafter.
Drive Level:	100µWatts typ., 500µWatts max.
Storage Temperature Range:	-50° to +105°C
Crystal Holder:	Resistance-weld hermetic seal
RoHS Status:	Compliant
Supply format:	Bulk pack (Radial tape and reel is available)

ESR and OSCILLATION MODE

Frequency Range MHz	Crystal Cut Osc. Mode	ESR Ohms Max.
3.2 ~ 3.4	AT-Fund	300
3.5 ~ 6.0	AT-Fund	120
6.1 ~ 10.0	AT-Fund	60
10.1 ~ 30.0	AT-Fund	40
24.0 ~ 48.0	BT-Fund	40
27.0 ~ 30.0	AT-3rd OT	150
30.1 ~ 50.0	AT-3rd OT	100
50.1 ~ 70.0	AT-3rd OT	80

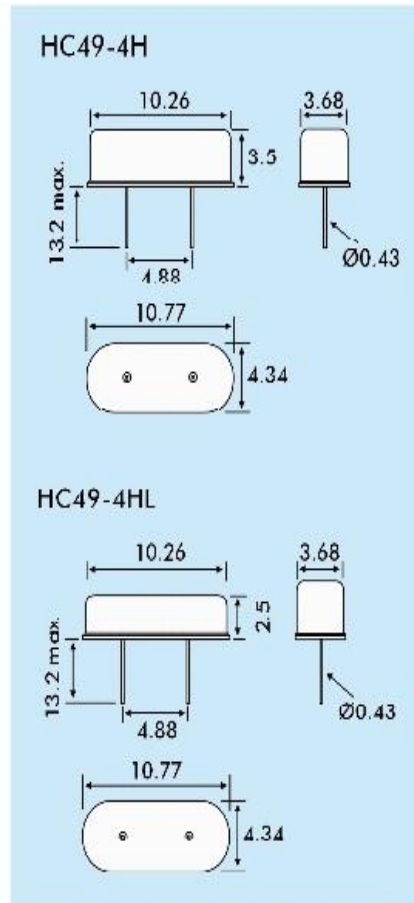

Figure 27: 16MHz Crystal Datasheet

APPENDIX E

PCB BOARD DIAGRAM

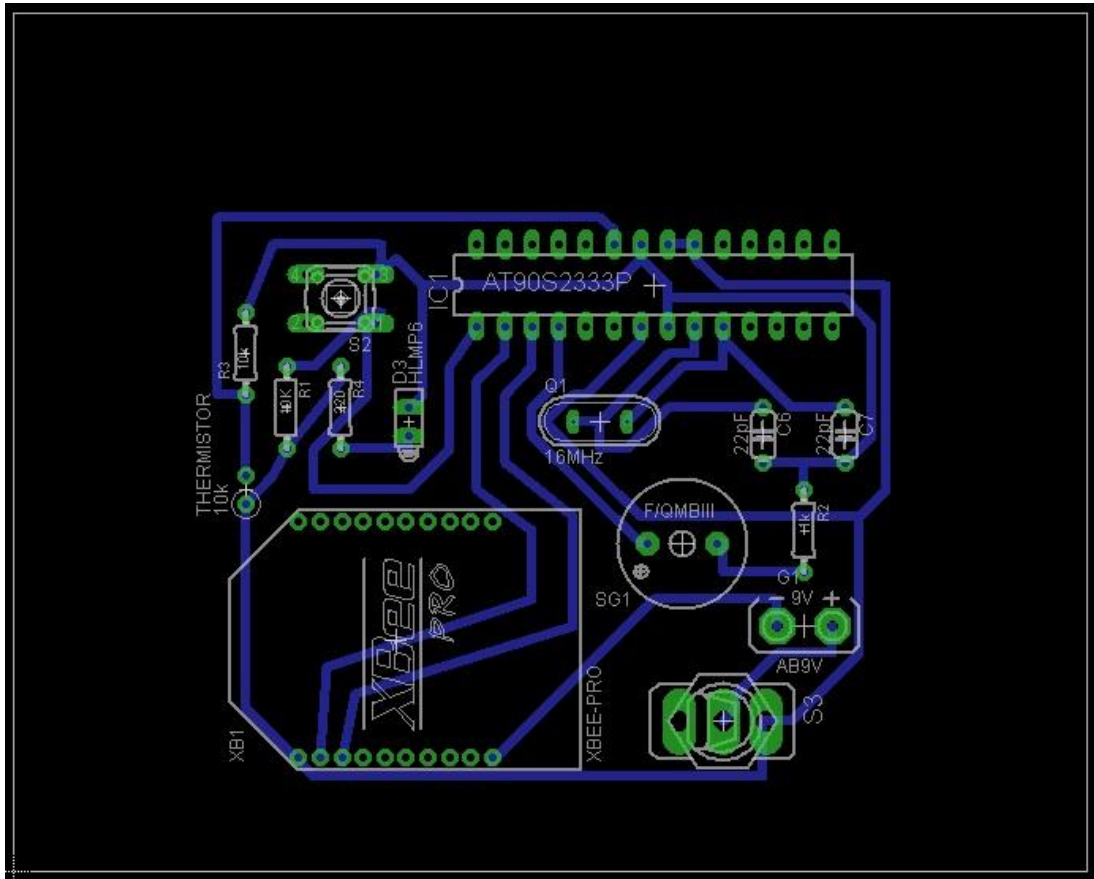

Figure 28: Board Diagram of circuit using Eagle Cad

APPENDIX F

PROJECT CODING

```
#include <math.h>

double Thermister(int RawADC)
{
double Temp;

Temp = log(((10240000/RawADC) - 10000));

Temp = 1 / (0.001129148 + (0.000234125 * Temp) +
(0.0000000876741 * Temp * Temp * Temp));

Temp = Temp - 273.15; // Convert Kelvin to Celcius
return Temp;
}

void setup()
{
  Serial.begin(9600);
}

void loop()
{
  double fTemp;

  int Temp = Thermister(analogRead(0));

  Serial.print("Current Temp: ");

  Serial.print(int(Temp),DEC);

  Serial.print('.'); //print a dot '.' on LCD

  Serial.print(Temp%10,DEC);

  Serial.print(" C ");
}
```

```
if (Temp>=33)
  beep ();
  if (Temp<33)
    ok ();
    delay(1000);
}
void beep()
{
  digitalWrite(buzzer,HIGH); //buzzer on
  Serial.println(" FEVER ");
  delay(100); //short delay
  digitalWrite(buzzer,LOW); //buzzer off
  delay(100); //short delay
}
void ok()
{
  Serial.println(" GOOD ");
  delay(500);
}
```

APPENDIX G

TEMPERATURE AND SENSOR CHARACTERISTIC

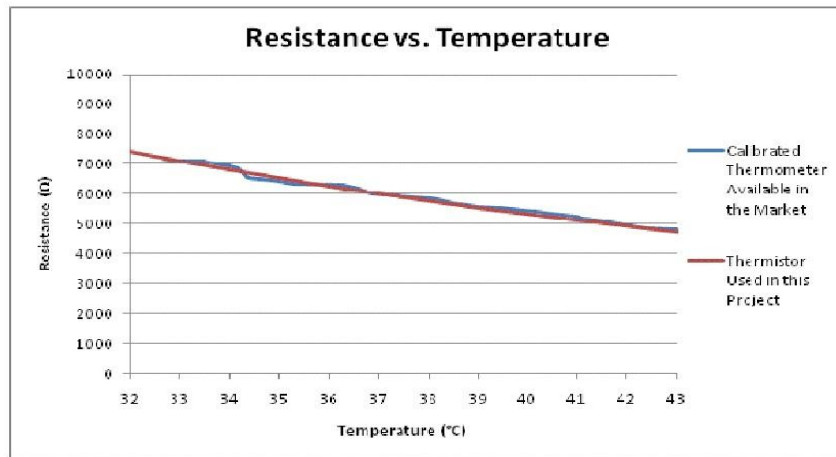

Figure 29: Resistance vs. Temperature of a Calibrated Thermometer against the Thermistor

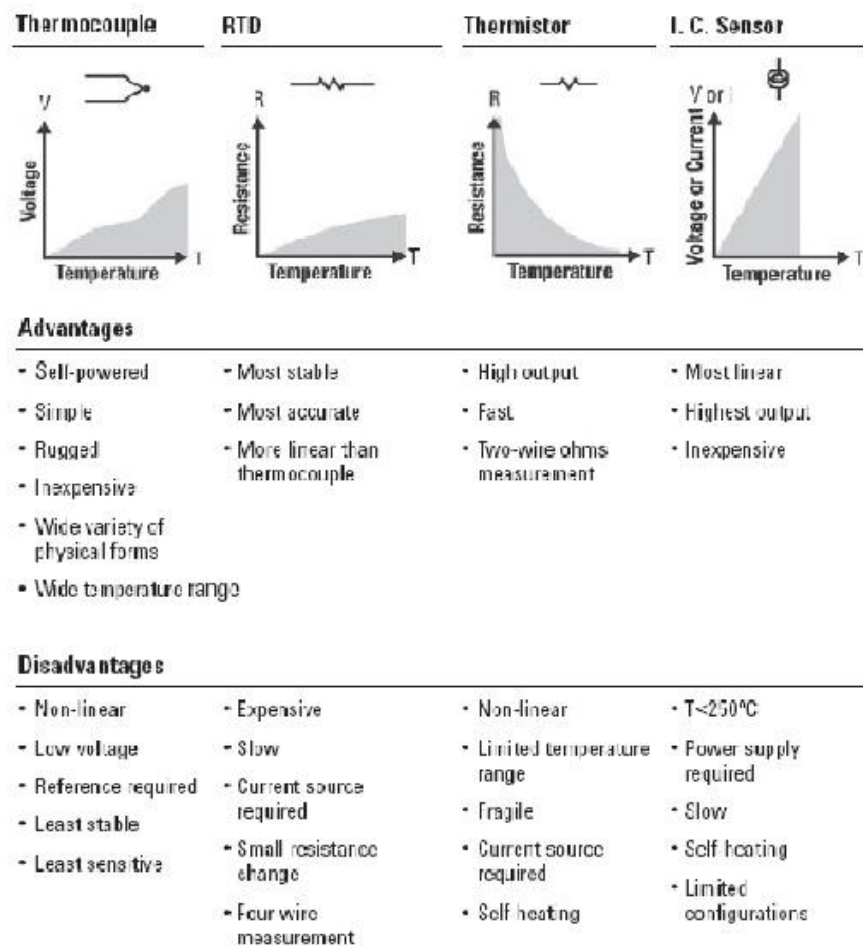

Figure 30: Temperature Sensor Comparison