

UNIVERSITI
TEKNOLOGI
PETRONAS

Alternative Solution to Sand Blanket in Vertical Drain

by

Zatul Iffah Binti Mohd Nor

Dissertation submitted in partial fulfillment of
the requirements for the
Bachelor of Engineering (Hons)
(Civil Engineering)

JAN 2008

Universiti Teknologi PETRONAS
Bandar Seri Iskandar
31750 Tronoh
Perak Darul Ridzuan

CERTIFICATION OF APPROVAL

Alternative Solution to Sand Blanket in Vertical Drain

by

Zatul Iffah Binti Mohd Nor

A project dissertation submitted to the
Civil Engineering Programme
Universiti Teknologi PETRONAS
in partial fulfilment of the requirement for the
BACHELOR OF ENGINEERING (Hons)
(CIVIL ENGINEERING)

Approved by,

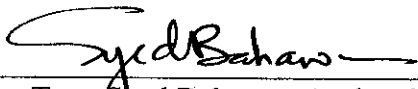

(Dr. Tuan Syed Baharom Azahar Syed Osman)

UNIVERSITI TEKNOLOGI PETRONAS

TRONOH, PERAK

January 2008

CERTIFICATION OF ORIGINALITY

This is to certify that I am responsible for the work submitted in this project, that the original work is my own except as specified in the references and acknowledgements, and that the original work contained herein have not been undertaken or done by unspecified sources or persons.

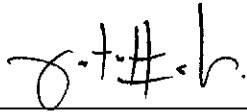

ZATUL IFFAH BINTI MOHD NOR

ACKNOWLEDGEMENT

I wish to express my sincere appreciation to my project supervisors, Dr Tuan Syed Baharom Syed Azahar and Dr Amer Awad Ali for their encouragement and guidance to see the completion of this project. I am also very thankful to Mr Eric Chan and Mr Loh Hin Leong from NYLEX (Malaysia) Berhad, Dr Gue See Sew from G&P Professionals Sdn Bhd providing me with the necessary materials and advice from the practitioners' point of view. Not forgetting, Dr Affendi Abdullah from Ranhill Bersekutu Sdn Berhad, who had initiated this topic for me.

Lastly, I am very much grateful for the kind support and love received from my parents, Dato Mohd Nor Idrus and Datin Ruhana Abdullah for without them, this project may not have come to see the light of day. Friends whom have extended their hands helping me with this project; thank you very much.

ABSTRACT

Construction industry in Malaysia had a brief sand shortage problem in the year 1996, and as sand becoming increasingly expensive over the years, and the unavailability of clean sand at site can hinder the construction process, alternative material is needed to replace the sand application in the vertical drain system. The report explains briefly on what constitutes a soft soil; its properties and characteristic as well as problems arise from the construction on soft ground. Concept on vertical drain is illustrated to further understand how vertical drain accelerates consolidation in soft soils, different types of vertical drains, and specifically on the prefabricated vertical drain (PVD) and the components of the vertical drains system. The possible use of geocomposite drain i.e Stripdrain™ as an alternative material to replace the sand blanket as the drainage layer in the vertical drain system is studied. Experimental values of the discharge capacity and settlement rate of soil for both drainage systems are included in this report and comparisons were made. The Stripdrain™ system was found to provide better drainage in the vertical drain system.

TABLE OF CONTENTS

| | |
|---|-------------|
| CERTIFICATIONS | i |
| ACKNOWLEDGEMENT | iii |
| ABSTRACT | iv |
| TABLE OF CONTENTS | v |
| LIST OF FIGURES | vii |
| LIST OF TABLES | viii |
| CHAPTER 1: INTRODUCTION | 1 |
| 1.1 Background of Study | 1 |
| 1.2 Problem Statement | 1 |
| 1.3 Objectives and Scope of Study | 2 |
| CHAPTER 2: LITERATURE REVIEW | 3 |
| 2.1 Soft Soils | 3 |
| 2.2 Vertical Drains | 3 |
| 2.3 Geotextile Application in Construction | 10 |
| 2.4 Geocomposite Drains | 13 |
| CHAPTER 3: METHODOLOGY | 16 |
| 3.1 Methodology Part 1 | 16 |
| 3.2 Methodology Part 2 | 17 |
| 3.3 Hazard Analysis | 21 |
| CHAPTER 4: RESULTS AND DISCUSSIONS | 23 |
| CHAPTER 5: CONCLUSIONS AND RECOMMENDATIONS | 31 |

| | | | | | | | | | |
|-------------------|---|---|---|---|---|---|---|---|-----------|
| REFERENCES | . | . | . | . | . | . | . | . | 32 |
| APPENDICES | . | . | . | . | . | . | . | . | 35 |

LIST OF FIGURES

| | |
|--|----|
| Figure 2.1: Typical vertical drain installation for a highway embankment | 4 |
| Figure 2.2: Prefabricated vertical drain | 6 |
| Figure 2.3: Installation of vertical drain by rig | 6 |
| Figure 2.4: Sand Index (Source: CIRC) | 9 |
| Figure 2.5: Typical geocomposite drains | 14 |
| Figure 2.6: Stripdrain™ | 15 |
| Figure 3.1: Methodology flow chart – FYP 1 | 16 |
| Figure 3.2: Methodology flow chart – FYP 2 | 17 |
| Figure 3.3: Schematic diagram of the experiment | 18 |
| Figure 3.4: Dimension of the equipment | 18 |
| Figure 3.5: PVD being placed inside the soil mass before loading | 19 |
| Figure 3.6: LVDT being placed at the centre to record settlement | 20 |
| Figure 3.7: Stripdrain with PVD | 20 |
| Figure 4.1: Discharge capacity graph (Stripdrain™) | 23 |
| Figure 4.2: Settlement rate (Stripdrain™) | 24 |
| Figure 4.3: Discharge capacity rate (Sand Blanket) | 25 |
| Figure 4.4: Settlement rate (Sand Blanket) | 25 |
| Figure 4.5: Comparison in the discharge rate | 26 |
| Figure 4.6: Comparison in the settlement rate | 26 |
| Figure 4.7: Comparison in sand thickness | 27 |
| Figure 4.8: Comparison in prices | 28 |
| Figure 4.9: Stripdrain™ application in Ha Tien plant, Vietnam | 28 |

LIST OF TABLES

| | |
|--|----|
| Table 2.1: Common types of vertical drains (after Rixner et al. 1986) | 5 |
| Table 2.2: Average Prices of Building Materials in Malaysia (MBAM) | 8 |
| Table 2.3: Stripdrain [™] Technical Specifications | 15 |
| Table 4.1: Thickness of sand layer | 27 |
| Table 4.2: Price Comparison | 28 |
| Table A.1: Building Material Cost Index 2005 | 35 |
| Table A.2: Average Price of Building Materials for Peninsular Malaysia (BMDAM) 2006 | 36 |
| Table A.3: LVDT Readings (Stripdrain [™]) | 37 |
| Table A.4: LVDT Readings (Sand blanket) | 40 |
| Table A.5: Discharge Capacity (Stripdrain [™]) | 43 |
| Table A.6: Discharge Capacity (Sand Blanket) | 45 |

CHAPTER 1

INTRODUCTION

1.1 Background of the Project

The consolidation settlement of soft clay or compressible soil with high water content will take a long time to complete. It is important to ensure that the excess water be removed from the soil before construction begins to avoid settlement problems. Vertical drains are installed together with preloading by surcharge embankment or vacuum pressure to provide an easier drainage path which the water can escape. Fill/surcharge is placed on site to start the movement of water. The increased pore water pressure exerts a force which moves the water to the nearest drain path and up to the drainage layer at the surface of the site, under the fill/surcharge.

The drainage layer – usually a layer of permeable sand blanket is the significant part of the project and an alternative material that exhibits the same properties as the sand will be studied to replace sand as the drainage layer. A feasible alternative solution that will be considered in the project is the use of geotextile as the horizontal drainage under the fill.

1.2 Problem Statement

In conventional method, sand blanket is laid beneath the fill to act as the drainage layer connected to the vertical drains installed at site. However, in places where it is hard to obtain clean sand and considering the rising cost of sand over the years, an alternative material to replace this sand blanket is needed. Therefore, geotextile is considered to act as the drainage layer in the project, and its characteristic will be studied to ensure that its performance meet the drainage criteria needed to discharge the water from the vertical drain.

1.3 Objectives and the Scope of Study

The main objective of this study is to find an alternative solution to replace sand blanket as the drainage layer. The potential material which is considered in this study is the use of geotextile and comparison between the two materials will be discussed. Comparison in terms of its drainage capacity will be studied and the costs involved using the different materials in construction will be made later in the project.

The scope of study will cover a comparison of performance in soft soil improvement using the prefabricated vertical drain (PVD) coupled with sand blanket as the drainage layer, PVD coupled with the horizontal drain. It is to be understood that the drainage layer could be of any material as long as it has the same drainage capacity as the sand blanket. The use of geotextile horizontal drainage i.e Stripdrain™ will be discussed in depth for this project.

The project for this semester will cover research and experimental works over the feasibility of using geotextile to replace sand as the drainage layer. Variables to be looked into are the discharge capacity, settlement and the increase in shear strength of the sample soil. Comparisons are to be made between the two drainage systems and a laboratory conclusion on the performance of both methods could be drawn. The results and data established from the study hopefully will be helpful in selecting the appropriate method for future field application.

CHAPTER 2

LITERATURE REVIEW

2.1 Soft Soils

Soft soils represent a general term to describe a wide range of soils which are in common having high moisture content, low bearing capacity and a high compressibility. The cohesion and the angle of friction are low, depending on the high water content. Soft soils can range from pure organic soils with organic debris like peat to fine grained sediments like clays and silts and in between a mixture of these two.

Fine grained sediments like clay have low permeability and take a very long time to consolidate. Vertical drains are used to accelerate the consolidation process to improve the soft soil condition so that excessive and differential settlement will not occur during and after construction commenced.

2.2 Vertical Drains

2.2.1 Introduction to Vertical Drain

One of the soft soil improvement methods is by using the vertical drains. Vertical drains are artificially –created drainage paths which can be installed on soil which is compressible and takes a very long time to consolidate. Bergado et al.(1994) stated that the purpose of vertical drain installation is twofold. First is to accelerate the consolidation process of the clay subsoil, and secondly; to gain rapid strength increase to improve the stability of structures on weak clay foundations.

Figure 2.1 illustrates a typical vertical drain installation for highway embankments. In this method, pore water escaped during the consolidation of the clay due to the hydraulic gradient exerted by the preloading and moves freely along the drains vertically towards the permeable drainage layers (i.e sand blanket).

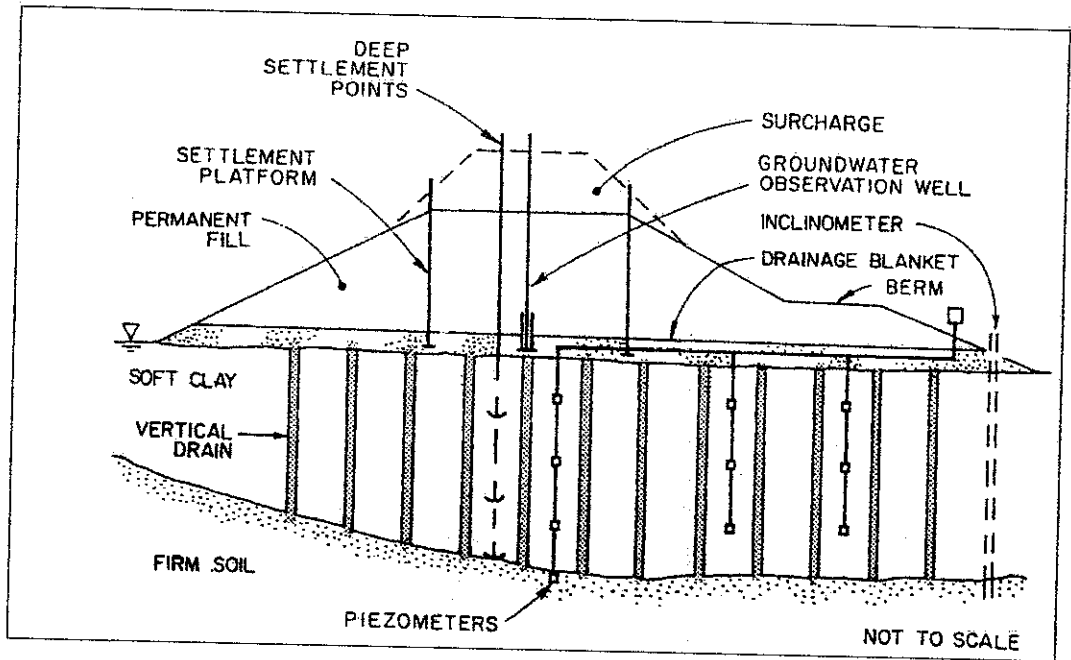

Figure 2.1: Typical vertical drain installation for a highway embankment (after Rixner et al. 1986)

There are 3 common types of vertical drains, namely : sand drains, fabric encased sand drains, and prefabricated vertical drains. Table 2.1 summarises the 3 types accordingly. Only prefabricated vertical drain (PVD) will be discussed in the paper as it is one of the geotextile applications to improve the soft soil condition.

Table 2.1 : Common types of vertical drains (after Rixner et al. 1986)

| General types | Sub-Types | Remarks |
|--------------------------------------|---|--|
| Sand Drains | Closed end mandrel Screw type auger Continuous flight hollow stem auger Internal jetting Rotary jet Dutch jet-bailer | Maximum displacement Limited experience Limited displacement Difficult to control Can be non-displacement Can be non-displacement |
| Fabric Encased Sand Drains | Sandwick, Pack Drain, Fabridrain | Full displacement of relative small volume |
| Prefabricated Vertical Drains | Cardboard drain Fabric covered Plastic drain without jacket | Full displacement of small volume |

2.2.2 Prefabricated Vertical Drain (PVD)

Prefabricated vertical drain or most commonly known as wick drain is used to replace the conventional sand drains as sand drains are susceptible to damage from lateral ground movement. An effective prefabricated vertical drain (PVD) has two basic filtration functions: first to retain soil particles; and second, to allow water to pass from the soil into the PVD core (Terzaghi filter criteria).

PVD is composed of a plastic core, protected by fabric filter with a longitudinal channel (Figure 2.2). The plastic core shall be made of continuous plastic fabricated to facilitate drainage along the axis of the drain, while the fabric filter shall be capable of resisting all bending, punching and tensioning subjected during installation and the design life of the drain.

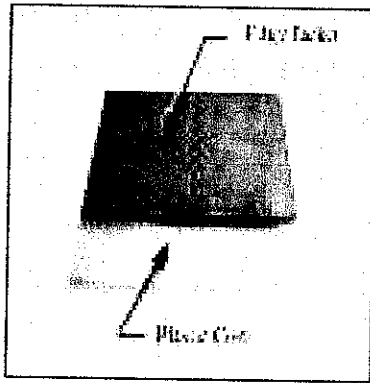

Figure 2.2 : Prefabricated Vertical Drain

PVDs are installed either by using a static or dynamic method. In static system, the mandrel is inserted into the soil via a static force. Dynamic installation involved a conventional drop hammer or a vibrating hammer to push the mandrel into the soil. Static system is preferable as it creates less disturbance of the surrounding soil. A typical installation of vertical drain by rig is shown in Figure 2.3.

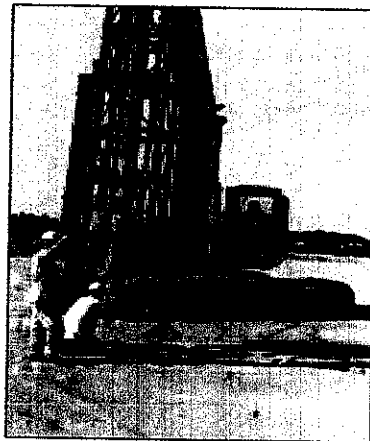

Figure 2.3 : Installation of vertical drain by rig (courtesy of TerraSystems Inc.)

2.2.3 Components of a Vertical Drains System

Vertical drains accelerate consolidation in soft soil with high content of organic material and very high water content. Water is squeezed out during the consolidation due to preloading and it flows vertically upward to the drainage path (sand blanket) before being discharged to the appropriate discharge points. Preloading generally refers to the application of surcharge load on the site prior to the placement of the final construction load until most of the primary consolidation is achieved. The two

common preloading techniques are conventional preloading, e. g. by means of an embankment, and vacuum induced preloading.

An important component of vertical drains system would be field instrumentation for monitoring the performance of the embankments to control the geotechnical problems and to improve settlement predictions so to provide guidelines for future projects. Field instrumentation can be divided into two groups (Bo et al.,2003). The first is to prevent sudden failures during construction and instruments used are the settlement plates, inclinometers and piezometers. The second group uses the multilevel settlement gauges and piezometers to record changes in the rate of settlement and excess pore pressure during loading stages. (refer to Figure 2.1)

2.2.4 Granular Graded Drainage System (Sand Blanket)

Drainage blanket i.e sand blanket is used to expel water away from the vertical drains and to provide a sand-working mat for vertical drain rigs. With sufficient horizontal drainage rate in the drains, they modify the hydraulic gradient of vertical flow in the vertical drain to accelerate consolidation. The sand blanket is the main concern for this project where another material is required to act as the drainage layer for the vertical drains system. This is due to the problem of availability and high cost of clean sand to be used for drainage blanket. The conventional method has been to install a sand layer (sand blanket), usually about 1m (3 ft.) thick, under the surcharge. This method sometimes overestimates the discharge capacity of the sand blankets resulting in inadequate lateral drainage that has compromised the function of the vertical drain system.

In the year 1996, Malaysia, especially in Selangor and Federal Territory was facing a serious sand shortage that could disrupt the construction and manufacturing sectors. Due to the shortage in the two areas, the price of sand had shot up between RM30 and RM40 a tonne.(extracted from : Malaysia Today 25th May 2006)

The Real Estate and Housing Developers' Association Malaysia (REHDA) Selangor has urged the Selangor state government to urgently look into the shortage of sand supply which is affecting property developers in the state. Its chairman Muztaza

Mohamad said that fellow developers were facing a critical shortage of sand, and that the problem be solved with long term solutions such as opening of more sand mines. He said since mid-2003, housing developers in the state had been facing difficulties in obtaining adequate supply of sand, causing project disruptions due to the sand issue. (Utusan Malaysia, March 7 2006)

Table 2.2 shows the joint statement from Masters Builders Association Malaysia (MBAM), Real Estate Housing Developer Association (REHDA), Persatuan Kontraktor Melayu Malaysia (PKMM) and Persatuan Kontraktor India Malaysia (PKIM).

Table 2.2 : Average Prices of Building Materials in Malaysia(MBAM)

| Average Prices Of Building Materials | | | RM | |
|--------------------------------------|------------|----------|------------|---------------------|
| Building Materials | Unit | 2005 | 2006 | 2007/(31March 2007) |
| Ordinary Portland Cement | bag (50kg) | GCP+0.20 | GCP + 0.50 | GCP + 10% |
| Mild Steel Round Bars | metric ton | | | |
| 9-10mm x 12m | | GCP+ 50 | GCP+ 150 | GCP+ RM350 to RM550 |
| 12mm x 12 m | | GCP+ 50 | GCP+ 150 | GCP+ RM350 to RM550 |
| 16-32mm x 12mm | | GCP+ 50 | GCP+ 150 | GCP+ RM350 to RM550 |
| High Tensile Deformed Bars | metric ton | | | |
| 9-10mm x 12m | | GCP+ 50 | GCP+ 150 | GCP+ RM350 to RM550 |
| 12mm x 12 m | | GCP+ 50 | GCP+ 150 | GCP+ RM350 to RM550 |
| 16-32mm x 12mm | | GCP+ 50 | GCP+ 150 | GCP+ RM350 to RM550 |
| 1/4" Clear Glass Sheet | p.s.f | 0.90 | 1.00 | 1.10 |
| Bricks | | | | |
| Common Clay Bricks | piece | 0.20 | 0.25 | 0.28 |
| Cement Clay Bricks | | 0.12 | 0.14 | 0.20 |
| 3/4" Granite Coarse Aggregate | metric ton | 20.00 | 21.60 | 24.00 |
| Sand | metric ton | 28.00 | 30.00 | 32.00 |

To see the increase of cost in sand prices, Construction Industry Resource Centre (CIRC) Building Materials Cost Index is used. Cost index is one of the most important items in cost data, particularly with regards to forecasting techniques which rely on historical data.

The objective of cost index is to measure changes in the cost of an item from one point of time to another. A base data is chosen, usually given the value of 100, all past and future increases or decreases being related to this figure. Figure 4.1 shows the trend of increase in the cost index with the year 2002 as the base data. Cost index does not give the exact price of sand at the various states.

The prices of sand in Malaysia are attached in APPENDIX 1

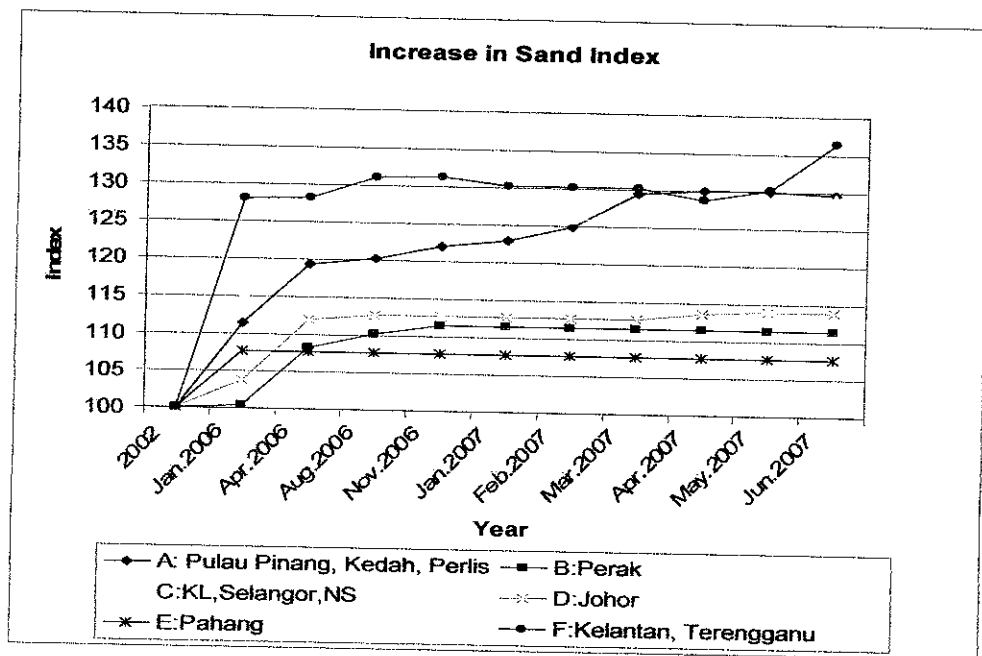

Figure 2.4: Sand Index (source: CIRC)

The increasing trend of sand prices over the years is expected to continue rising. The unavailability of sand has caused problems to the construction industry and therefore the use of geotextiles is considered to replace drainage and filtration function of sand in construction.

2.3 Geotextile Application in Construction

2.3.1 Introduction

Based on ASTM D4439-02, geotextile is defined as a permeable geosynthetic comprised solely of textiles, whereas geosynthetic is a planar product manufactured from polymeric material used with soil, rock, earth, or other geotechnical engineering related material as an integral part of man-made project, structure, or system. The application of geotextiles has been accepted in civil engineering works. Geotextiles have an excellent performance in discharging the pore water to dissipate the pore water pressure much faster than the original soil mass (Rowe 1992; Loh 1998)

Nagahara et al. (1999) studied the behaviour of high embankment with geotextile horizontal drain in Noto Airport in Japan. Horizontal geotextile drains were embedded in the embankment to dissipate the excess pore water pressure. Settlement, lateral displacement, pore water pressure, and earth pressure within the embankment were measured during the construction. The results obtained shown that the horizontal geotextile drains used, perform both as drainage and reinforcement to the embankment.

Prefabricated vertical drains drastically shorten the consolidation times in soft cohesive soil (Figure 2.4) but in order it to function properly, a drainage path must be provided to receive flow from the drains and direct it under the surcharge to the appropriate discharge points. This horizontal drainage system must perform without applying excessive pressure to the vertical drains. The use of geotextile strip drains can provide an alternative to the use of sand or granular drainage blanket.

2.3.2 Functions of Geotextile

Yeo (2003) mentioned in his paper that there are four basic functions of geotextile. These are :

1. Drainage

A geotextile functions as a drain when it collects a liquid and conveys it towards an outlet. However the capacity of fabrics is limited and geocomposite drains have been developed to provide increased capacity. The flow of water into the drain is controlled by the geotextile must also perform a filter function to prevent loss of capacity due to soil clogging into the drain. The drainage-in-the-plane is termed transmittivity as contrast to permittivity for filtration.

2. Filtration

A geotextile placed in contact with soil, allowing water to pass through while preventing the movement of soil particles. Both adequate permittivity and soil retention are required simultaneously over the design life of filtration application.

3. Separation

A geotextile is placed between two different soils, preventing the two soils from intermixing.

4. Reinforcement

A geotextile is used to improve the mechanical properties of an earth structure by interacting with soil through interface shear.

The drainage and filtration function of a geotextile has made it as the most probable alternative to replace the sand blanket in the vertical drain system. Yeo (2003) also mentioned the use of a geocomposite drains for increased drainage capacity compared to the geotextile fabric as the possible drainage application.

2.3.3 Geotextiles in Drainage Application

A properly functioning drain must retain the surrounding soil while readily accepting water from the soil and removing it from the area. While granular drains have a long performance history, geotextile use in drains is relatively recent and performance data are limited to approximately 25 years.

However, geotextiles have been used to replace graded granular filters in almost all drainage applications because of their comparable performance, improved economy, consistent properties and the ease of installation method. Without proper design, their performance cannot be ascertained properly. Therefore, geotextiles must be designed to perform equally as graded granular filters.

Geotextiles must have the capability to allow water to flow through the filter into the drain, and to continue doing this throughout the life of the project (survivability) and also to retain the soil particles in place and to prevent their migration (piping) through the filter. (If some soil particles do move, they must be able to pass through the filter without blinding or clogging the downstream media during the life of the project).

Christopher (1994) mentioned that for drainage beneath pavement permeable bases, **blanket drains**, and base courses, geotextile use can be justified over conventional graded granular filter material use because of cost advantage from:

- Use of less-costly drainage aggregate;
- Possible use of smaller-sized drains;
- Possible elimination of collector pipes;
- Expedient construction;
- Lower risk of contamination and segregation of aggregate during construction; and
- Reduced excavation

Summarised criteria that should be considered for the design of geotextile filters are :

- A retention criterion to avoid piping,
- A permeability criterion to ensure the geotextile is permeable enough to allow liquid to pass through relatively unhindered,
- An anti-clogging criterion to ensure the geotextile is porous enough
- A survivability and durability criterion to ensure the geotextile survives installation and durable enough to withstands its project life.

2.4 Geocomposite Drains

ASTM D4439-02, Standard Terminology for Geosynthetics define geocomposite as a product composed of two or more materials, at least one of which is geosynthetics i.e geotextile.

Yeo (2003) stated that since the capacity of fabrics (geotextile alone) is limited, geocomposite drains have been developed to provide increased capacity. In the past 20 years, prefabricated geocomposite drains have become a standard method of groundwater drainage for a wide variety of purposes.(McKean 1999). In many cases these drains are cheaper, easier to construct, and require less space (as they are usually thinner) than conventional drains constructed using aggregate wrapped in geotextile. Geocomposite drains are composed of a three-dimensional core sandwiched between two geotextiles.

In the same way that waterproofing ground with puddle clay or concrete has been superseded over the years by the use of plastic geomembrane linings, drainage geocomposites are rapidly eliminating the need for sand and gravel in traditional land drainage blankets. (WTB Geotechnics)

Consideration needs to be given to the drain core failure modes including short-term crushing of the core under a normal force, long-term creep compression of the plastic core, and rapid or long term elongation of the fabric, allowing intrusion of the fabric into the pathways between the net strands or cusps. A drain may also fail due to soil, biological, or chemical clogging or blinding of the geotextile.

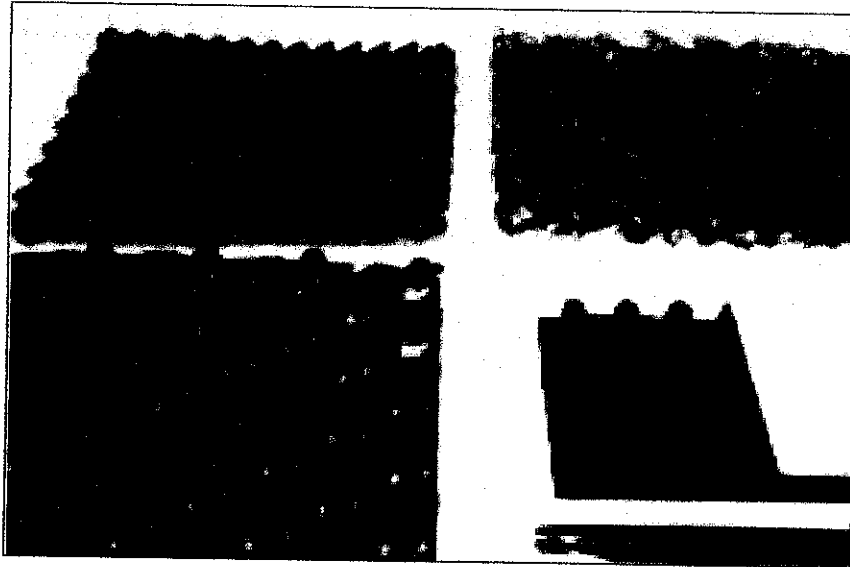

Figure 2.5: Typical geocomposite drains

Another factor that was accounted in the selection of geocomposite drains over the conventional sand blanket is the cost savings through the elimination of multi-trucking of granular material either to or on site. According to the WTB Geotechnic website, this is because a single trailer-load of geocomposite can cover an area otherwise requiring more than 150 truck-loads of granular material. The speed of installation too must be added to the savings factor. (A small work crew can easily install 4000m² of geocomposite per day.)

However, extensive laboratory testing is required to determine the geocomposite drain's performance to find out if it would have equivalent or better performance under the site conditions than a sand layer.

Stripdrain™ manufactured by NYLEX Malaysia is used in the experiment to replace the sand blanket as the drainage system. Its technical specifications are given below:

Table 2.3: Stripdrain™ - Technical Specifications

| Properties | Test Method | Unit | Stripdrain™ | | | |
|-------------------------------------|-------------|----------------------|------------------------|---------|---------|------|
| Core Structure | - | | Double Cusped Profile | | | |
| Core Material | - | | HDPE | | | |
| Std. Compressive Strength | Nominal | kN/m ² | 120 | 200 | 280 | 300 |
| Std. Thickness | Nominal | mm | 40 | 20 | 15 | 8 |
| Free Surface Area | Nominal | % | >90 | >90 | >90 | >90 |
| Flow Rate @ 1% Gradient | ASTM D 4716 | Lit./min./m width | 102 | 50 | 36 | 10 |
| Width | Nominal | mm | 100,200,300,400,500 | | | |
| Geotextile Filter Properties | | | | | | |
| Structure | - | | Non-woven Spunbonded | | | |
| Material | - | | PP/PET | | | |
| Grab Tensile Strength | ASTM D 4632 | N | 400 | | | |
| Tear Strength | ASTM D 4533 | N | 150 | | | |
| Permeability | ASTM D 4491 | 10 ⁻⁴ m/s | 1 | | | |
| Packing Details | | | Packing Details | | | |
| Roll Length | Nominal | m | 25/50 | 50/100 | 70/120 | 130 |
| Roll Diameter | Nominal | m | 1.1/1.7 | 1.1/1.7 | 1.1/1.7 | 1.15 |



Figure 2.6: Stripdrain™

CHAPTER 3
METHODOLOGY

3.1 Methodology Part 1 –Preliminary Research and Literature Review

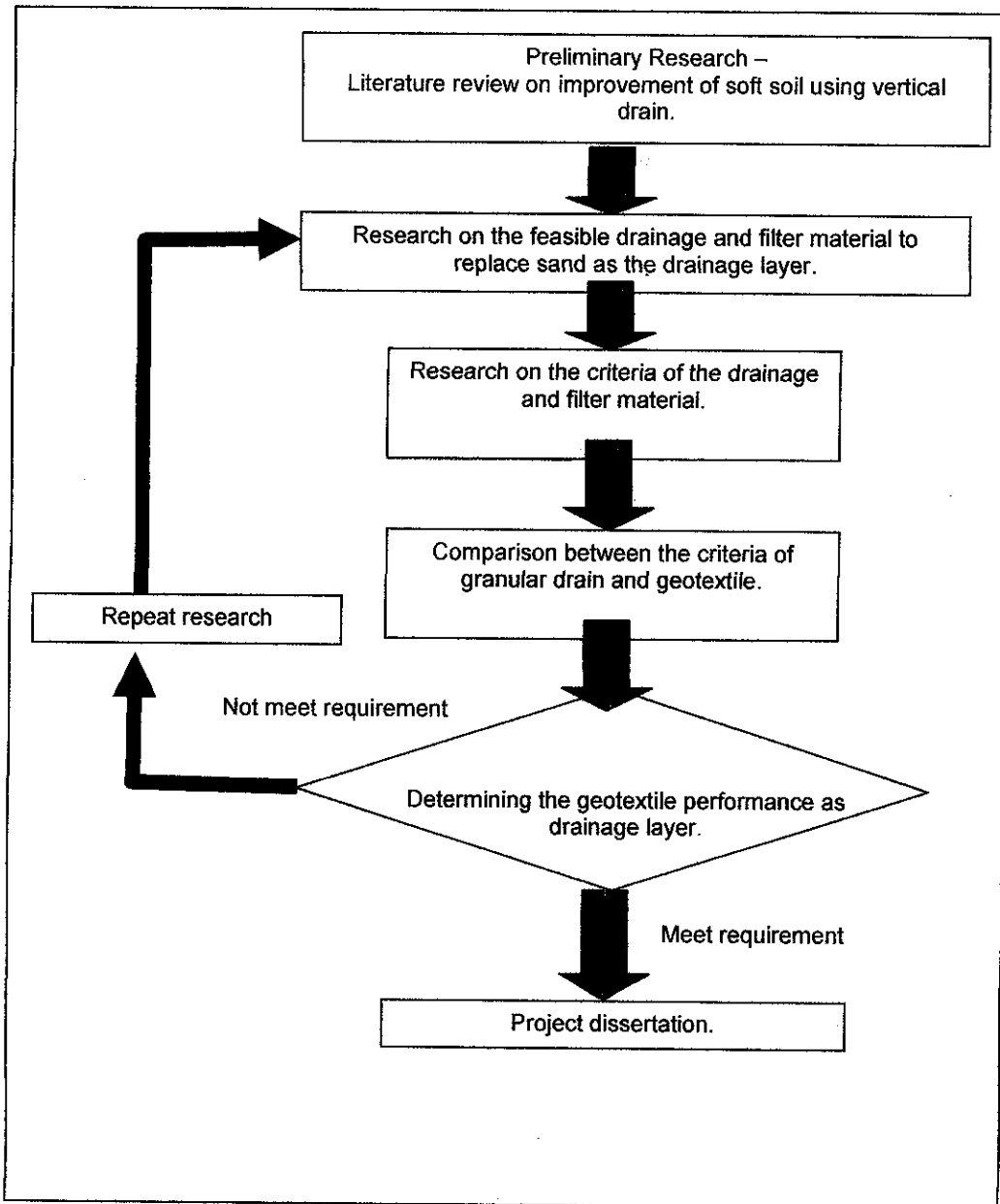

Figure 3.1 : Methodology Flow Chart –FYP 1

3.2 Methodology Part 2 – Experiment

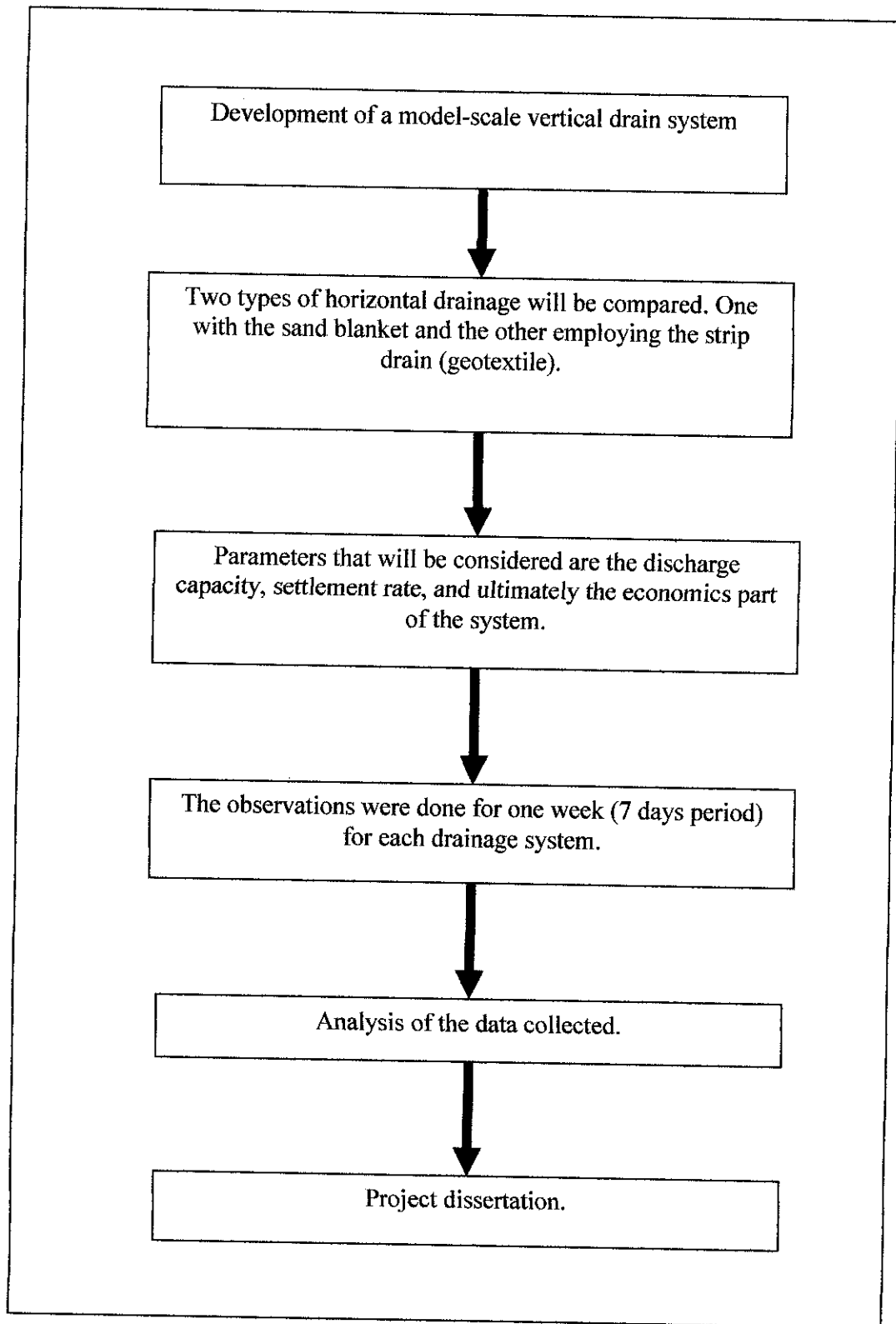

Figure 3.2 : Methodology Flow Chart (FYP 2)

3.2.1 Experiment Setup

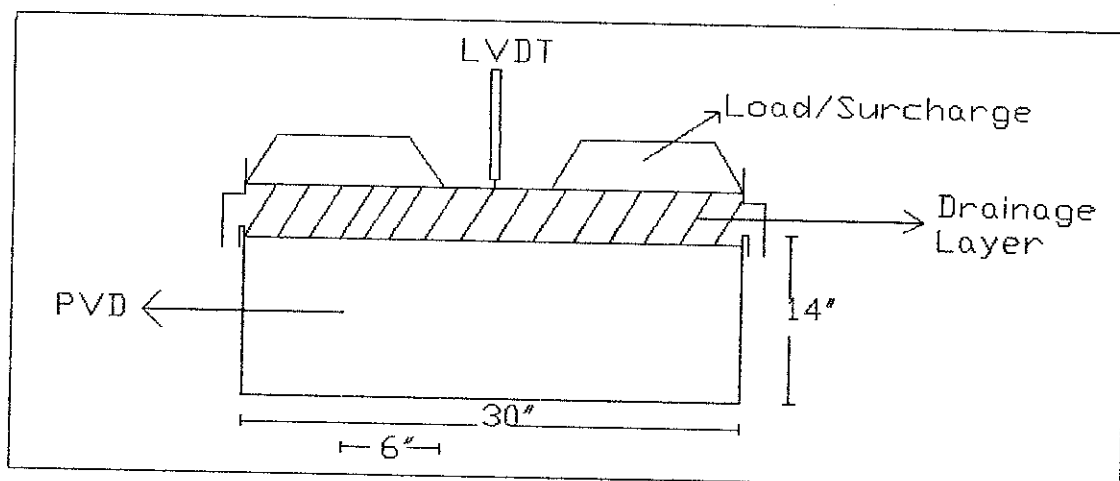

Figure 3.3 : Schematic Diagram of the Experiment

Note:

Prefabricated vertical drain (PVD): Create an artificial drainage path in soil mass.

Linear Variable Differential Transducer (LVDT): Measure settlement due to the consolidation process.

Drainage Layer: 2 sets of experiment were conducted; first using a single layer of Stripdrain and the second with a sand blanket (10 cm thickness)

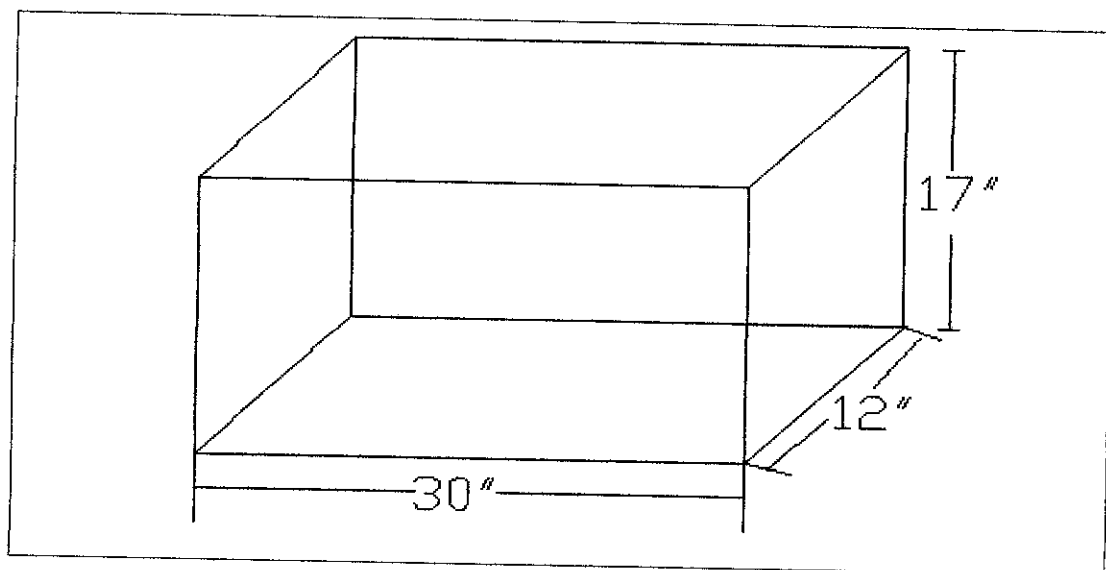

Figure 3.4 : Dimension of the Equipment

3.2.2 Experiment Methodology

1. Clay soil was first dried up for 24 hours before being crushed to pass the 2 mm sieve size. The dried soil was then mixed with water to achieve 80% moisture content to create a slurry soil.
2. The slurry soil is placed into the container, then 4 PVDs were pushed inside the soil with spacing of 6 inches (about 15 cm) apart. (Figure 3.5)
3. The drainage layer (Stripdrain or Sand blanket) was laid on top of the slurry soil, before a plastic cover was placed on top of the drainage layer. The load (80kg) was then placed on top and the LVDT was set up in between the loads (See Figure 3.6)

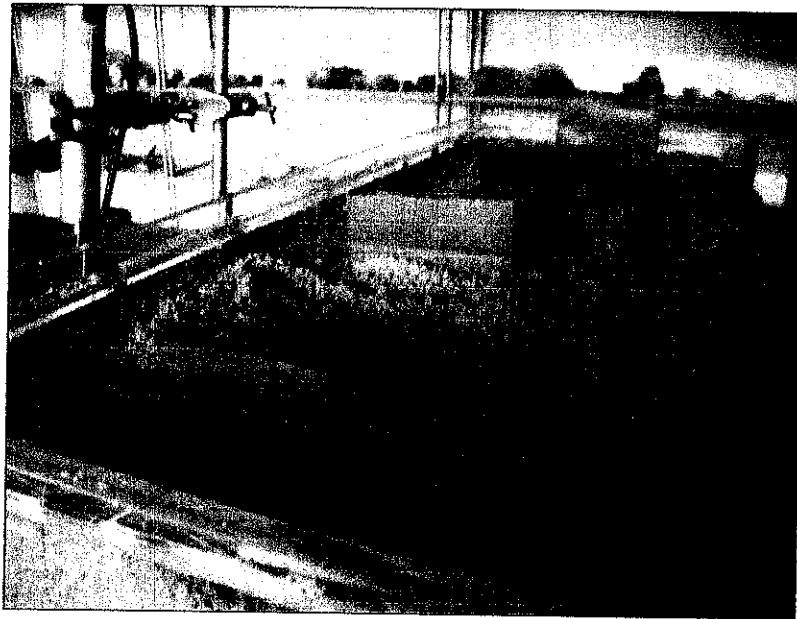

Figure 3.5: PVD being placed inside the soil mass before loading

4. The plastic tube connecting the drain is placed inside a measurement cylinder and the discharge rate was observed. The settlement rate was measured by the LVDT.
5. Observations were made for 8 days for each experiment.

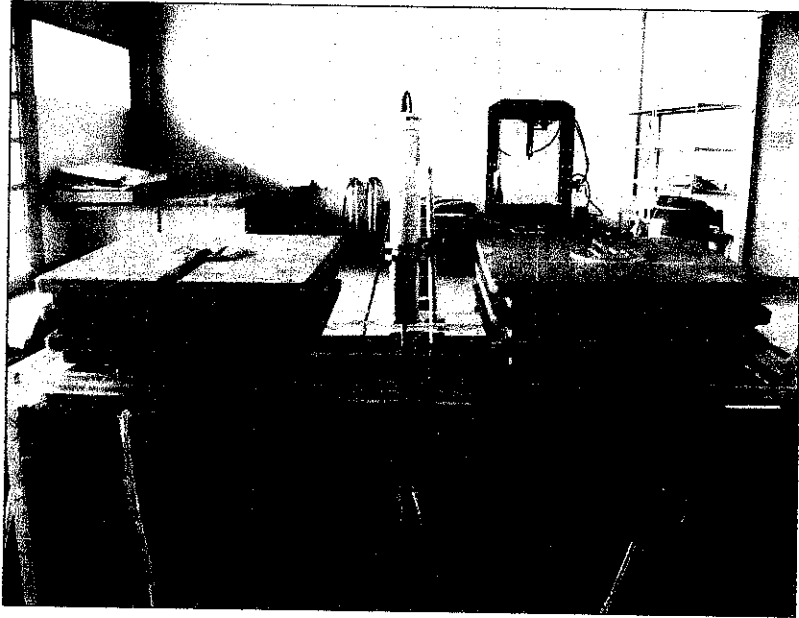

Figure 3.6: LVDT being placed at the centre to record settlement

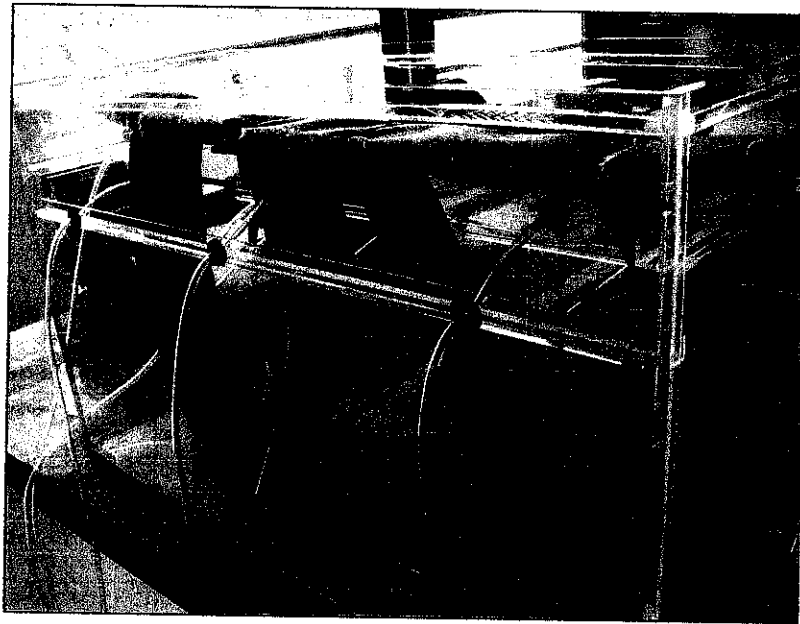

Figure 3.7: Stripdrain with PVD

3.3 Hazard Analysis

3.3.1 Hazard Identification

Hazard is a condition or combination of conditions that, if left uncorrected may lead to an accident, illness, or property damage. The importances of hazard identification in this project are to:

- increase awareness of workplace hazards,
- provide opportunity to identify and control workplace hazards,
- increase productivity,
- prevent an occupational injury or illness.

Possible sources of hazards :

1. Sources of extreme temperatures (drying oven)
2. Sources of harmful dust (dried clay particles)
3. Sources of sharp objects (hammer and knives)
4. Layout of the workplace and location of co-workers (housekeeping)
5. Electrical sources (computer and logging devices)
6. Ergonomic issues

3.3.2 Ergonomics

Ergonomics is science concerned with the “fit” between people and their work.

It puts people first, taking into account their capabilities and limitations.

Ergonomics makes sure that tasks, equipment, information and the environment suit every worker. Ergonomics consider the person’s:

A. Physical aspects;

- body size and shape,
- fitness and strength,
- posture,
- senses e.g. vision, hearing, touch and
- stresses and strains on muscles, joints and nerves.

B. Psychological aspects;

- mental abilities,
- personality,
- knowledge and
- experience.

A major ergonomic consideration in this project is computer usage. This is an example of how computer usage can cause possible hazards:

- screen poorly positioned, too high/low, close/far,
- mouse placed too far away, have to stretch,
- chair not adjustable,
- screen glare, eye strain/fatigue,
- not suitable hard and softwares for the task or person using them,
- not enough breaks or changes of activity

These factors can lead to mistakes, poor productivity, stress, eye strain, headache, pain and aches. Therefore, identifications of these hazards are important to avoid problems in the future.

CHAPTER 4

RESULTS AND DISCUSSION

4.1 Results

Two sets of experiments were conducted to study the effectiveness of the drainage layer in terms of its drainage capacity, settlement and cost.

4.1.1 Results for Stripdrain™ System

The monitored discharge profile for the Stripdrain™ system is shown below:

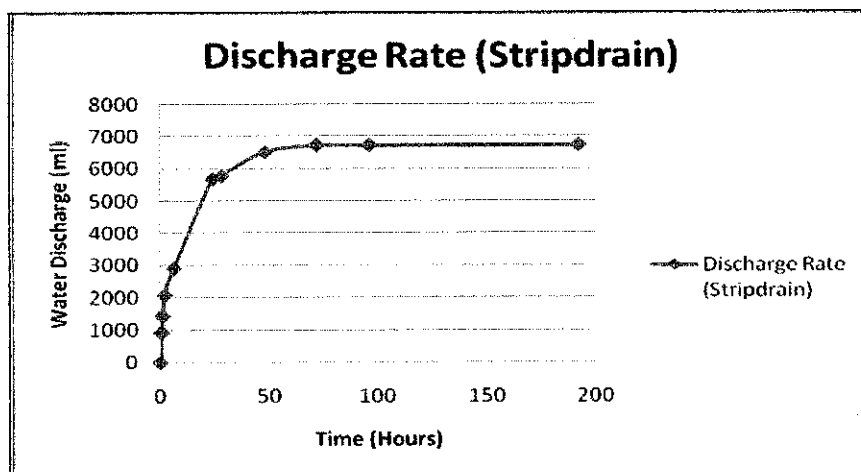

Figure 4.1: Discharge Capacity Graph (Stripdrain™)

The maximum amount of water discharged at the end of day 8 is 6720 ml. It can be seen, that there was a rapid discharge rate from day one to day two. However during the third day, there was little water being discharged through the outlets. It was found later that the tube connecting the strip drain and the discharge outlet was bent, explaining the impossible flow of water out from the system.

There is a rapid settlement rate from day one to two, consistent with the amount of water discharging from the system. The maximum settlement value is 87.38 cm. The settlement rate graph from the first set of experiment is as follows:

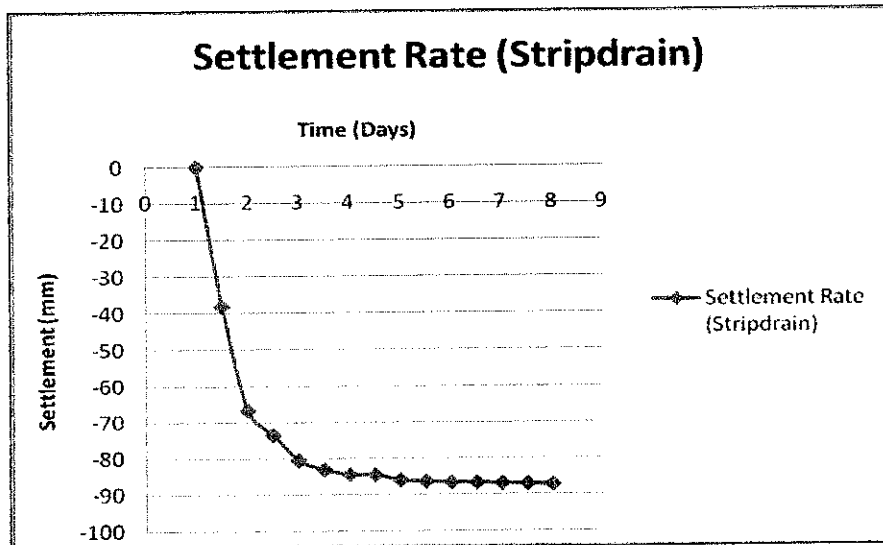

Figure 4.2: Settlement Rate (Stripdraintm)

4.1.2 Results for Sand Blanket System

For the sand blanket drainage system, the observed discharge profile is as follows:

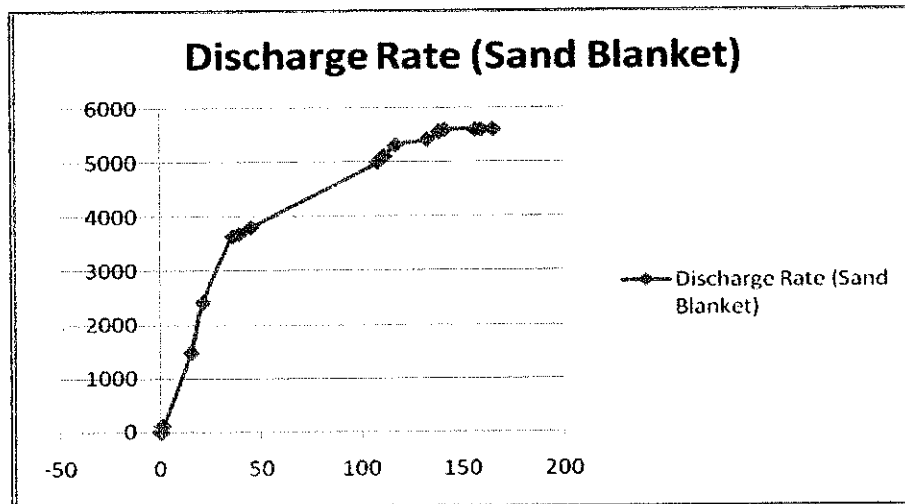

Figure 4.3: Discharge Capacity Rate (Sand Blanket)

The maximum amount of water discharged is 5600 ml. There is a lag in time before water started to be discharged through the sand blanket. This may be due to the denser arrangement of sand particles that slow down the flow rate of water compared to the Stripdraintm. Overestimation of the discharge capacity of the sand blankets can result in inadequate lateral drainage that will compromise function of the vertical drain system.

As for the settlement rate, the final settlement achieved at the end of the experiment is 57.84 cm.

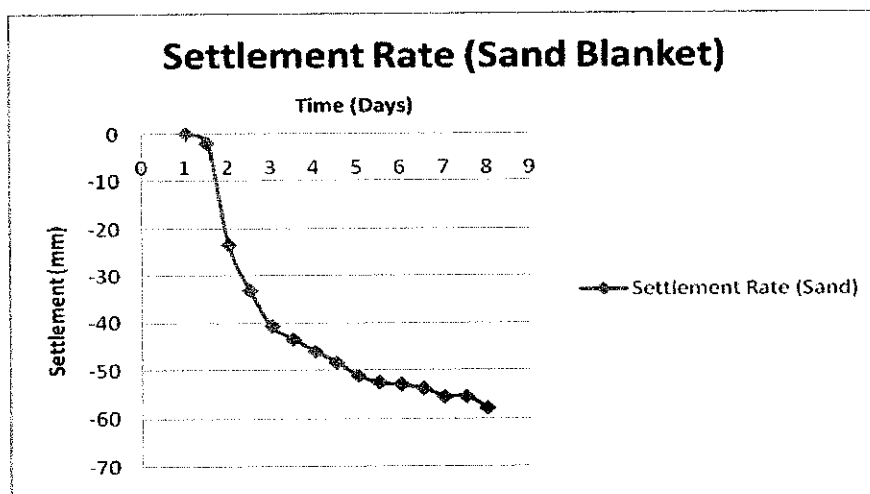

Figure 4.4: Settlement Rate (Sand Blanket)

Figure 4.5 shows a clearer comparison in the discharge rate for both drainage systems. There is a difference up to 16 % in the amount of water discharged. The amount of surcharge load applied in the experiment may not be sufficient to exert the necessary pressure to force more water out from the soil mass.

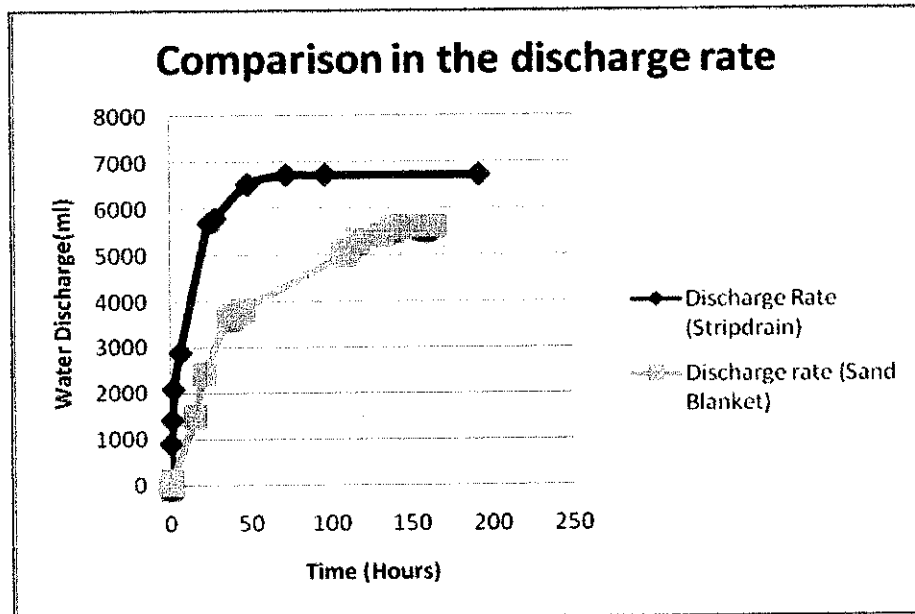

Figure 4.5: Comparison in the discharge rate

The final amount of settlement obtained after day eight of the experiment shows that the amount of settlement from the Stripdrain system is about 30% more than the sand blanket system.

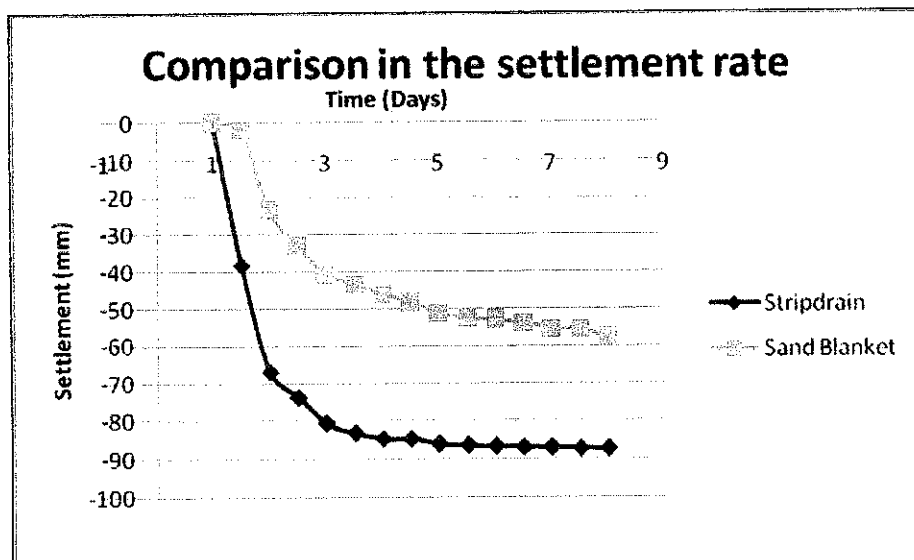

Figure 4.6: Comparison in the settlement rate

4.1.3 Economic Analyses

From the interview with Mr Eric Chan from Nylex Malaysia, he revealed that the usual thickness of sand blanket used is 1m (3ft). However, if Stripdraintm is used as the drainage layer together with the sand blanket, the minimum thickness of sand will be adequate for the drainage system to function properly.

For field application:

Table 4.1: Thickness of sand layer

| Drainage Type | Thickness (mm) |
|---|----------------|
| Sand Blanket | 1000 |
| Minimum Sand Blanket + Stripdrain tm | 300 |

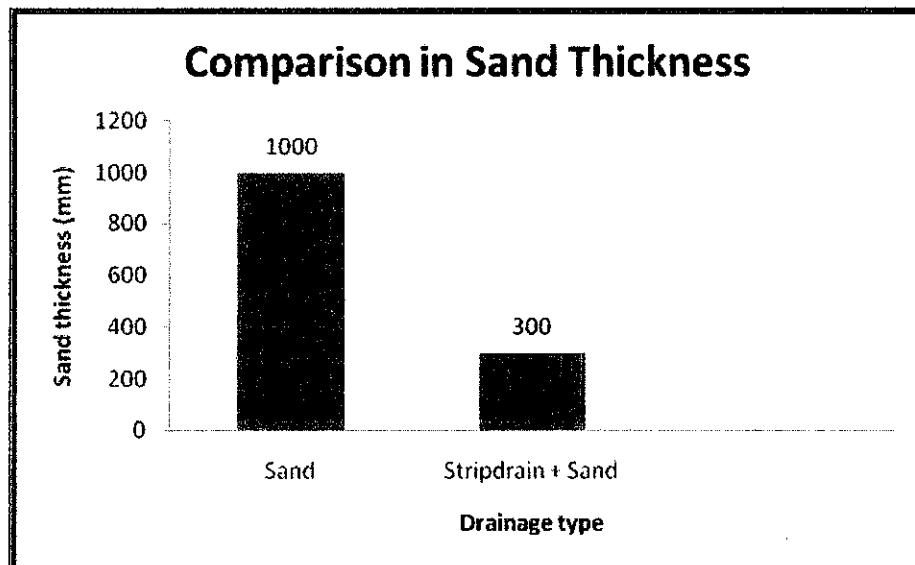

Figure 4.7: Comparison in Sand Thickness

There will be up to 70 percent reduction in the amount of sand used for the drainage system. The 300 cm thick of sand usually acts as a working platform on a very soft soil which has very low bearing capacity.

For 1m² of area:

Note: 1 cubic meter of sand ~ 1.6 metric tonne of sand

Table 4.2: Price Comparison

| Sand | |
|----------------------------------|-------------|
| Volume (m ³) | 1.0 |
| Metric Tonne | 1.6 |
| Price (RM) per metric tonne | 51.2 |
| Stripdrain + 300 cm Sand Blanket | |
| Length | 1 |
| Price (RM) per meter | 21.4 |

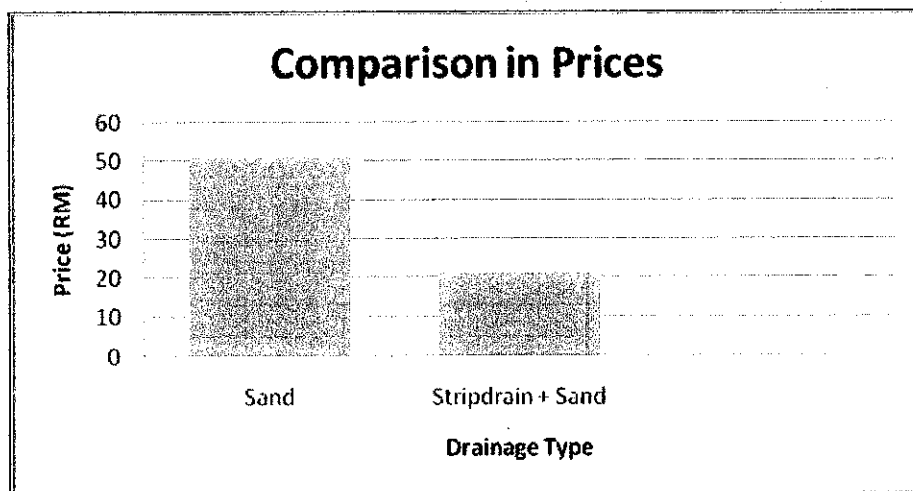

Figure 4.8: Comparison in Prices



Figure 4.9: Stripdrain[™] Application in Ha Tien Plant, Vietnam (Courtesy of Nylex)

4.2 Discussion

There have been arguments on the usage of geocomposite drain to replace sand as the drainage layer in terms of the performance and cost. An interview with Dr SS Gue from GNP Geotechnics Sdn Bhd revealed that:

1. Vertical drain is used on very soft soil, indicating that a sand blanket is needed not only as drainage but to provide a working platform for the vertical drain rig.
2. Sand has very high permeability. (0.4 cm/sec) which is why sand is preferred over geotextiles. In terms of performances and cost. Very rare cases involving the sand blanket which affect the vertical drain performances.
3. Cost is highly relative. Performances however, needed to be ascertain properly. Sand has been proven to be highly effective.
4. Vertical drain is subjected to bending. Like a straw, there will be a flow cut. Even if there is the possibility of using the horizontal geosynthetic drain, a connection must be developed to ensure continuous flow.
5. The bearing capacity issue of the very soft soil needs to be considered.

4.2.1 Alternative material for sand blanket

The need to find an alternative solution to the sand blanket layer in vertical drain is mainly due to:

- The increasing price of sand over the years.
- The problem of availability clean sand at site.
- Increased understanding of geotextiles application in construction.

The sand blanket function in vertical drain is very important to ensure proper consolidation can take place within the required time. Sand has been proven to provide a functional drain system; however failure to design a proper granular graded drain, mostly result in over estimation of the discharge capacity of the vertical drain.

To overcome the shortcomings of sand in the drainage system, geotextile is considered as an alternative material to replace sand in construction for drainage and filtration purposes. This is due to the comparable factors such as the lower cost installation and ease of handling of geotextile products, its flow capacity, strength and durability in which all of these performances are tested and the uniform properties of geotextile can assure predictable performances on field.

CHAPTER 5

CONCLUSIONS AND RECOMMENDATIONS

Geocomposite drain is considered to be the most suitable solution to replace the sand blanket in the vertical drain system. From the laboratory experiments conducted, the following conclusions can be drawn:

1. Stripdraintm proved to be a better drainage system compared to the sand blanket in terms of its drainage capacity and settlement rate.
2. Up to fifty percent (50%) cost reduction in Stripdraintm application compared to the sand blanket.

However, since the application of geotextiles is vast and there are still applications that are constantly going through changes to better its properties, a standard of classification for geotextile is needed before it can be adopted to replace the granular graded drain. Geotextiles require proper engineering design or they may not perform as desired. Unless flow requirements, piping resistance, clogging resistance and survivability requirements are properly specified, the geotextile/soil filtration system may not perform properly. Properly designed geotextiles can be used as a replacement for most drainage application over the conventional granular drains.

Recommendation to further strengthen the findings is that real field applications data and costs to be considered in the economics analyses. The suitability of Stripdraintm application on different type of soils could be studied to further understand the behaviour of geocomposite drains as a replacement material for the sand blanket.

REFERENCES

- ASTM Standard D 4439-02, "Standard Terminology for Geosynthetics", ASTM International, West Conshohocken, PA, www.astm.org.
- ASTM Standard D 4491-99a(200d)e1, "Standard Test Method for Water Permeability of Geotextiles by Permittivity", ASTM International, West Conshohocken, PA, www.astm.org.
- A.V.S.R. Murty, S.K. Soni and Sudhir Mathur, "*Use of geotextiles in road pavements*" Central Road Research Institute, New Delhi, India. Geosynthetics Asia '97, 26-29 November, Bangalore , India.
- B. Indraratna, C.Rujikiatkamjorn, J.Chu, 2007, "*Soft Clay Stabilization with Geosynthetic Vertical Drains beneath Road and Railway Embankments : A critical review of Analytical Solutions and Numerical Analysis*" Faculty of Engineering, University of Wollongong.
- Barry R. Christopher, 1994, "*Geotextiles in Filtration Applications*" Geosynthetics Asia '97, 26-29 November, Bangalore , India.
- Braja M. Das. 2006. *Principles of Geotechnical Engineering*, Brooks/Cole Thomson Learning.
- Chua Kang Tor, Jimmy Lee Shen Sun, "*Evaluation of Discharge Capacity of Prefabricated Vertical Drain,*" PSB Corporation.

Cedergren, Harry R., *Seepage, Drainage, and Flow Nets*, John Wiley & Sons, New York, 1989, pp 151,154,156, 165.

D.T Bergado, L.R Anderson, N.Miura, A.S Balasubramaniam.1996. *Soft Ground Improvement in Lowland and Other Environments*. ASCE Press.

D.T Bergado, R.Manivannan, A.S Balasubramaniam, 1995, "*Filtration Criteria for Prefabricated Vertical Drain Geotextile Filter Jackets in Soft Bangkok Clay*"
Geosynthetics International,1996, Vol 3, No 1.

G.A. Lorenzo, D.T. Bergado, W. Bunthai, D. Hormdee, P. Phothiraksanon, 2003, "*Innovations and performances of PVD and dual function geosynthetic applications,*"
Department of Geotechnical Engineering, School of Civil Engineering, Asian Institute of Technology.

H.Nagahara, H. Takeda, N.Tsuruyama, T.Imai, T. Ishiguro, T. Fujiyama, M. Itoh, H. Ohta, 1999, "*Behaviour of high airport embankment with geotextile horizontal drain*"
Geosynthetics – 7th ICG- Delmas, Courc & Girard (eds)©2002 Swets & Zeitlinger, Lisse
ISBN 90 5809 523 1

J.Chu, M.W. Bo, V.Choa, 2006, "*Improvement of ultra-soft soil using prefabricated vertical drains,*" *Journal of Geotextiles and Geomembranes* 24(2006) 339-348.
<www.sciencedirect.com>

Jim McKean, 1999, "*Field Evaluation of the Long Term Performance of Geocomposite Sheet Drains,*" Department of Geological Sciences, University of Canterbury, Christchurch, New Zealand edited by USDA Forest Service, Technology and Development Centre, San Dimas, California.

Joint Departments of the Army and Air Force, TM 5-818-8/AFJMAN 32-1030,
Engineering Use of Geotextiles, 20 July 1995,

J.P. Giroud, S.M. Luetlich, G.N. Richardson, A.Zhao, “ *Permeability of geotextile and granular filters*” Geosynthetics – 7th ICG- Delmas, Courc & Girard (eds)©2002 Swets & Zeitlinger, Lisse ISBN 90 5809 523 1

K.H Blume, W. Wilmers, 1976, “*Embankments on Soft Soil*” Geosynthetics Asia ’97, 26-29 November, Bangalore, India.

Mohd Redzuan Ahmad, 2006, “*Comparison Between Predicted and Observed Settlement of Vertical Drain Treated Road Embankment on Soft Clay*”, Universiti Teknologi Malaysia.

Toyoaki Nogami and Maoxin Li, 2003, “ *Consolidation of Clay with a System of Vertical and Horizontal Drain,*” Journal of Geotechnical and Geoenvironmental Engineering, Vol 129 No. 9, September 1,2003©ASCE.

Yeo KC, 2003, “*Properties of geotextiles*”
www.hkpc.org/hkiemat/mastec03_notes/27.pdf

Construction Industry Resource Centre (CIRC) Building Materials Cost Index
<http://www.cidb.gov.my/cidb/information/tech/circ-bmci-my.html>

LINQ Industrial Fabrics, Inc. www.thracelinq.com/geotex/technote.html

Master Builder Association Malaysia, MBAM <http://www.mbam.org.com.my>

NILEX “Horizontal Strip Drains- Lateral Drainage Application Profile”
<http://www.nilex.com>.

Hazard Analysis Notes, [http://elearning .utp.edu.my](http://elearning.utp.edu.my).

<http://www.buildingtalk.com/news/wtb/wtb100.html>

APPENDIX 1

Table A.1 : Building material cost index 2005

| Building Material | Period | Region | | | | | |
|-------------------------|-----------|--------------------------------|-------|--|-------|--------|-----------------------------|
| | | A | B | C | D | E | F |
| | | Pulau Pinang, Kedah, Perlis | Perak | Selangor, Negeri Sembilan Melaka | Johor | Patang | Kuala Lumpur, Terengganu |
| (3) Sand | Jan. 2005 | 101.9 | 101.5 | 126.3 | 101.6 | 103.4 | 126.5 |
| | Feb. 2005 | 101.9 | 102.0 | 126.3 | 101.6 | 103.4 | 126.5 |
| | Mar. 2005 | 101.9 | 102.0 | 129.2 | 101.4 | 105.5 | 120.3 |
| | Apr. 2005 | 102.1 | 102.0 | 129.2 | 101.4 | 105.5 | 120.3 |
| | May. 2005 | 102.1 | 102.3 | 129.4 | 102.5 | 105.5 | 120.3 |
| | Jun. 2005 | 102.1 | 102.3 | 129.5 | 102.1 | 105.5 | 120.3 |
| | Jul. 2005 | 103.3 | 102.3 | 110.1 | 102.1 | 105.5 | 120.3 |
| | Aug. 2005 | 104.1 | 102.4 | 111.5 | 102.4 | 105.5 | 120.3 |
| | Sep. 2005 | 104.3 | 102.4 | 113.7 | 102.2 | 105.5 | 120.3 |
| | Oct. 2005 | 105.3 | 102.4 | 113.7 | 102.6 | 105.5 | 120.5 |
| | Nov. 2005 | 105.9 | 102.5 | 113.7 | 102.6 | 107.5 | 120.5 |
| | Dec. 2005 | 106.4 | 102.5 | 114.5 | 102.6 | 107.5 | 120.5 |
| (4) Steel Reinforcement | Jan. 2005 | 131.3 | 144.3 | 140.1 | 135.6 | 143.3 | 147.7 |
| | Feb. 2005 | 131.0 | 144.5 | 139.5 | 133.0 | 143.3 | 146.5 |
| | Mar. 2005 | 130.9 | 144.3 | 140.3 | 135.0 | 144.7 | 146.5 |
| | Apr. 2005 | 130.6 | 144.3 | 141.3 | 135.0 | 144.7 | 146.5 |
| | May. 2005 | 130.8 | 140.5 | 141.5 | 135.6 | 144.7 | 146.5 |
| | Jun. 2005 | 130.0 | 139.5 | 142.3 | 135.6 | 133.5 | 141.3 |
| | Jul. 2005 | 130.0 | 139.3 | 142.3 | 135.2 | 139.5 | 141.3 |
| | Aug. 2005 | 130.0 | 139.3 | 143.1 | 135.1 | 139.5 | 137.7 |
| | Sep. 2005 | 130.0 | 139.3 | 141.1 | 134.6 | 137.1 | 137.7 |
| | Oct. 2005 | 130.0 | 139.3 | 141.1 | 134.6 | 137.1 | 137.7 |
| | Nov. 2005 | 130.0 | 139.0 | 140.3 | 134.6 | 137.1 | 137.7 |
| | Dec. 2005 | 130.0 | 138.7 | 140.3 | 134.6 | 137.1 | 137.7 |

Source of Data: This index is compiled from data supplied by Department of Statistics, Malaysia

Table A.2: Average Price of Building Materials for Peninsular Malaysia (BMDAM) 2006

| No. | Description | Unit | Term | Del or Ex | Oct 2006 (RM) | | | | | |
|-----|--|------|------|-----------|---------------|----------|----------|----------|----------|----------|
| | | | | | P. Pinang | Selangor | Johor | Kelantan | Perak | Pahang |
| 1 | Ordinary Portland Cement (bulk) | MT | 60 | del | 204.00 | 202.00 | 204.00 | 209.33 | 197.33 | 209.33 |
| 2 | Granite Aggregate 3/4" | MT | 60 | ex | 18.67 | 19.33 | 19.67 | 20.00 | 20.00 | 18.67 |
| 3 | Normal River Sand | MT | 30 | ex | 12.33 | 15.33 | 15.33 | 7.00 | 5.00 | 6.67 |
| 4 | Fine River Sand for Plastering | MT | 30 | ex | 15.00 | 23.33 | 24.00 | 7.00 | 10.00 | 9.00 |
| 5 | Normal Mining Sand | MT | 30 | ex | 12.33 | 15.00 | 15.00 | 13.00 | 5.00 | 13.00 |
| 6 | Fine Mining Sand for Plastering | MT | 30 | ex | 15.00 | 21.67 | 22.33 | 17.67 | 10.00 | 16.67 |
| 7 | Mild Steel Round Bars - 10mm, MS146 | MT | 14 | del | 1,791.67 | 1,778.33 | 1,778.33 | 1,776.33 | 1,778.33 | 1,776.33 |
| 8 | Mild Steel Round Bars - 12mm, MS146 | MT | 14 | del | 1,753.67 | 1,741.33 | 1,741.33 | 1,741.33 | 1,741.33 | 1,741.33 |
| 9 | Mild Steel Round Bars - 16mm, MS146 | MT | 14 | del | 1,667.33 | 1,674.33 | 1,674.33 | 1,674.33 | 1,674.33 | 1,674.33 |
| 10 | Mild Steel Round Bars - 20mm, MS146 | MT | 14 | del | 1,667.33 | 1,674.33 | 1,674.33 | 1,674.33 | 1,674.33 | 1,674.33 |
| 11 | Mild Steel Round Bars - 22mm, MS146 | MT | 14 | del | 1,667.33 | 1,674.33 | 1,674.33 | 1,674.33 | 1,674.33 | 1,674.33 |
| 12 | Mild Steel Round Bars - 25mm, MS146 | MT | 14 | del | 1,667.33 | 1,674.33 | 1,674.33 | 1,674.33 | 1,674.33 | 1,674.33 |
| 13 | Mild Steel Round Bars - 32mm, MS146 | MT | 14 | del | 1,667.33 | 1,674.33 | 1,674.33 | 1,674.33 | 1,674.33 | 1,674.33 |
| 14 | High Tensile Deformed Bars - 10mm, MS146 | MT | 14 | del | 1,616.33 | 1,616.33 | 1,619.33 | 1,619.33 | 1,619.33 | 1,619.33 |
| 15 | High Tensile Deformed Bars - 12mm, MS146 | MT | 14 | del | 1,778.33 | 1,778.33 | 1,778.33 | 1,776.33 | 1,778.33 | 1,776.33 |
| 16 | High Tensile Deformed Bars - 16mm, MS146 | MT | 14 | del | 1,713.33 | 1,713.33 | 1,713.33 | 1,713.33 | 1,713.33 | 1,713.33 |
| 17 | High Tensile Deformed Bars - 20mm, MS146 | MT | 14 | del | 1,713.33 | 1,713.33 | 1,713.33 | 1,713.33 | 1,713.33 | 1,713.33 |
| 18 | High Tensile Deformed Bars - 25mm, MS146 | MT | 14 | del | 1,713.33 | 1,713.33 | 1,713.33 | 1,713.33 | 1,713.33 | 1,713.33 |
| 19 | High Tensile Deformed Bars - 32mm, MS146 | MT | 14 | del | 1,713.33 | 1,713.33 | 1,713.33 | 1,713.33 | 1,713.33 | 1,713.33 |

Source of Data: This average price is compiled from data supplied by BMDAM
 MT = Metric Ton or Tonne, Del = Delivered, Ex = Ex-Factory, Ex-Quarry, Ex-Sand Pit

APPENDIX 2

Table A.3: LVDT Readings (Stripdrain[™])

| Point | MEAS Time | | CH 00 mm |
|-------|-----------|----------|-------------|
| | Date | Time | |
| 1 | 4/7/2008 | 10:17:59 | -0.22 |
| 2 | 4/7/2008 | 10:18:29 | -13.46 |
| 3 | 4/7/2008 | 10:18:59 | -17.38 |
| 4 | 4/7/2008 | 10:19:29 | -20.16 |
| 5 | 4/7/2008 | 10:19:59 | -22.02 |
| 6 | 4/7/2008 | 10:20:29 | -23.16 |
| 7 | 4/7/2008 | 10:20:59 | -23.7 |
| 8 | 4/7/2008 | 10:21:29 | -28.27 |
| 9 | 4/7/2008 | 10:21:59 | -28.92 |
| 10 | 4/7/2008 | 10:22:29 | -29.37 |
| 11 | 4/7/2008 | 10:22:29 | -29.73 |
| 12 | 4/7/2008 | 10:23:59 | -30.3 |
| 13 | 4/7/2008 | 10:24:59 | -30.78 |
| 14 | 4/7/2008 | 10:25:59 | -31.22 |
| 15 | 4/7/2008 | 10:26:59 | -31.6 |
| 16 | 4/7/2008 | 10:27:59 | -31.96 |
| 17 | 4/7/2008 | 10:28:59 | -32.27 |
| 18 | 4/7/2008 | 10:29:59 | -32.57 |
| 19 | 4/7/2008 | 10:30:59 | -32.92 |
| 20 | 4/7/2008 | 10:31:59 | -33.25 |
| 21 | 4/7/2008 | 10:32:59 | -33.46 |
| 22 | 4/7/2008 | 10:33:59 | -33.55 |
| 23 | 4/7/2008 | 10:34:59 | -33.73 |
| 24 | 4/7/2008 | 10:35:59 | -33.96 |
| 25 | 4/7/2008 | 10:36:59 | -34.14 |
| 26 | 4/7/2008 | 10:37:59 | -34.29 |
| 27 | 4/7/2008 | 10:38:59 | -34.52 |
| 28 | 4/7/2008 | 10:39:59 | -34.68 |
| 29 | 4/7/2008 | 10:40:59 | -34.86 |
| 30 | 4/7/2008 | 10:41:59 | -35.03 |
| 31 | 4/7/2008 | 10:42:59 | -35.36 |
| 32 | 4/7/2008 | 10:43:59 | -35.44 |
| 33 | 4/7/2008 | 10:44:59 | -35.61 |
| 34 | 4/7/2008 | 10:45:59 | -35.74 |
| 35 | 4/7/2008 | 10:46:59 | -35.84 |
| 36 | 4/7/2008 | 10:47:59 | -35.95 |
| 37 | 4/7/2008 | 10:48:59 | -36.06 |
| 38 | 4/7/2008 | 10:49:59 | -36.18 |
| 39 | 4/7/2008 | 10:50:59 | -36.29 |
| 40 | 4/7/2008 | 10:51:59 | -36.46 |
| 41 | 4/7/2008 | 10:52:59 | -36.55 |
| 42 | 4/7/2008 | 10:53:59 | -36.7 |
| 43 | 4/7/2008 | 10:54:59 | -36.86 |
| 44 | 4/7/2008 | 10:55:59 | -36.97 |
| 45 | 4/7/2008 | 10:56:59 | -37.11 |
| 46 | 4/7/2008 | 10:57:59 | -37.26 |
| 47 | 4/7/2008 | 10:58:59 | -37.36 |
| 48 | 4/7/2008 | 10:59:59 | -37.65 |
| 49 | 4/7/2008 | 11:00:59 | -37.7 |
| 50 | 4/7/2008 | 11:01:59 | -37.77 |

| Point | MEAS Time | | CH 00 mm |
|-------|-----------|----------|-------------|
| | Date | Time | |
| 51 | 4/7/2008 | 11:02:59 | -37.89 |
| 52 | 4/7/2008 | 11:03:59 | -38.01 |
| 53 | 4/7/2008 | 11:04:59 | -38.12 |
| 54 | 4/7/2008 | 11:05:59 | -38.23 |
| 55 | 4/7/2008 | 11:06:59 | -38.33 |
| 56 | 4/7/2008 | 11:07:59 | -38.43 |
| 57 | 4/7/2008 | 11:08:59 | -38.53 |
| 58 | 4/7/2008 | 11:09:59 | -38.63 |
| 59 | 4/7/2008 | 11:10:59 | -38.74 |
| 60 | 4/7/2008 | 11:11:59 | -38.83 |
| 61 | 4/7/2008 | 11:12:59 | -38.94 |
| 62 | 4/7/2008 | 11:13:59 | -39.04 |
| 63 | 4/7/2008 | 11:14:59 | -39.13 |
| 64 | 4/7/2008 | 11:15:59 | -39.22 |
| 65 | 4/7/2008 | 11:16:59 | -39.33 |
| 66 | 4/7/2008 | 11:17:59 | -39.48 |
| 67 | 4/7/2008 | 11:18:59 | -39.57 |
| 68 | 4/7/2008 | 11:19:59 | -39.68 |
| 69 | 4/7/2008 | 11:20:59 | -39.77 |
| 70 | 4/7/2008 | 11:21:59 | -39.9 |
| 71 | 4/7/2008 | 11:22:59 | -40.43 |
| 72 | 4/7/2008 | 11:42 | -42 |
| 73 | 4/7/2008 | 12:02:59 | -43.26 |
| 74 | 4/7/2008 | 12:22:59 | -43.95 |
| 75 | 4/7/2008 | 12:42:59 | -44.64 |
| 76 | 4/7/2008 | 13:02:59 | -45.57 |
| 77 | 4/7/2008 | 13:22:59 | -46.48 |
| 78 | 4/7/2008 | 13:42:59 | -47.43 |
| 79 | 4/7/2008 | 14:02:59 | -48.26 |
| 80 | 4/7/2008 | 14:22:59 | -49.1 |
| 81 | 4/7/2008 | 14:42:59 | -49.83 |
| 82 | 4/7/2008 | 15:02:59 | -50.58 |
| 83 | 4/7/2008 | 15:22:59 | -52.46 |
| 84 | 4/7/2008 | 15:42:59 | -53.13 |
| 85 | 4/7/2008 | 16:02:59 | -53.98 |
| 86 | 4/7/2008 | 16:22:59 | -54.77 |
| 87 | 4/7/2008 | 16:42:59 | -55.72 |
| 88 | 4/7/2008 | 17:02:59 | -56.36 |
| 89 | 4/7/2008 | 17:22:59 | -57.04 |
| 90 | 4/7/2008 | 17:42:59 | -57.64 |
| 91 | 4/7/2008 | 18:02:59 | -58.3 |
| 92 | 4/7/2008 | 18:22:59 | -58.94 |
| 93 | 4/7/2008 | 18:42:59 | -59.48 |
| 94 | 4/7/2008 | 19:02:59 | -60.02 |
| 95 | 4/7/2008 | 19:22:59 | -60.54 |
| 96 | 4/7/2008 | 19:42:59 | -61.08 |
| 97 | 4/7/2008 | 20:02:59 | -61.56 |
| 98 | 4/7/2008 | 20:22:59 | -62.1 |
| 99 | 4/7/2008 | 20:42:59 | -62.57 |
| 100 | 4/7/2008 | 21:02:59 | -63.07 |

| Point | MEAS Time | | CH 00 |
|-------|-----------|----------|--------|
| | Date | Time | mm |
| 101 | 4/7/2008 | 21:22:59 | -63.48 |
| 102 | 4/7/2008 | 21:42:59 | -63.84 |
| 103 | 4/7/2008 | 22:02:59 | -64.31 |
| 104 | 4/7/2008 | 22:22:59 | -64.75 |
| 105 | 4/7/2008 | 22:42:59 | -65.17 |
| 106 | 4/7/2008 | 23:02:59 | -65.58 |
| 107 | 4/7/2008 | 23:22:59 | -65.99 |
| 108 | 4/7/2008 | 23:42:59 | -66.42 |
| 109 | 4/8/2008 | 0:02:59 | -66.83 |
| 110 | 4/8/2008 | 0:22:59 | -67.27 |
| 111 | 4/8/2008 | 0:42:59 | -67.68 |
| 112 | 4/8/2008 | 1:02:59 | -68.17 |
| 113 | 4/8/2008 | 1:22:59 | -68.63 |
| 114 | 4/8/2008 | 1:42:59 | -69.16 |
| 115 | 4/8/2008 | 2:02:59 | -69.52 |
| 116 | 4/8/2008 | 2:22:59 | -69.85 |
| 117 | 4/8/2008 | 2:42:59 | -70.18 |
| 118 | 4/8/2008 | 3:02:59 | -70.47 |
| 119 | 4/8/2008 | 3:22:59 | -70.73 |
| 120 | 4/8/2008 | 3:42:59 | -70.98 |
| 121 | 4/8/2008 | 4:02:59 | -71.24 |
| 122 | 4/8/2008 | 4:22:59 | -71.46 |
| 123 | 4/8/2008 | 4:42:59 | -71.76 |
| 124 | 4/8/2008 | 5:02:59 | -71.97 |
| 125 | 4/8/2008 | 5:22:59 | -72.28 |
| 126 | 4/8/2008 | 5:42:59 | -72.46 |
| 127 | 4/8/2008 | 6:02:59 | -72.74 |
| 128 | 4/8/2008 | 6:22:59 | -72.95 |
| 129 | 4/8/2008 | 6:42:59 | -73.21 |
| 130 | 4/8/2008 | 7:02:59 | -73.41 |
| 131 | 4/8/2008 | 7:22:59 | -73.65 |
| 132 | 4/8/2008 | 7:42:59 | -73.78 |
| 133 | 4/8/2008 | 8:02:59 | -73.98 |
| 134 | 4/8/2008 | 8:22:59 | -74.22 |
| 135 | 4/8/2008 | 8:42:59 | -74.39 |
| 136 | 4/8/2008 | 9:02:59 | -74.61 |
| 137 | 4/8/2008 | 9:22:59 | -74.76 |
| 138 | 4/8/2008 | 9:42:59 | -74.96 |
| 139 | 4/8/2008 | 10:02:59 | -75.18 |
| 140 | 4/8/2008 | 10:22:59 | -75.37 |
| 141 | 4/8/2008 | 10:42:59 | -75.55 |
| 142 | 4/8/2008 | 11:42:59 | -76.08 |
| 143 | 4/8/2008 | 12:42:59 | -76.6 |
| 144 | 4/8/2008 | 13:42:59 | -77.02 |
| 145 | 4/8/2008 | 14:42:59 | -77.51 |
| 146 | 4/8/2008 | 15:42:59 | -77.9 |
| 147 | 4/8/2008 | 16:42:59 | -78.25 |
| 148 | 4/8/2008 | 17:42:59 | -78.54 |
| 149 | 4/8/2008 | 18:42:59 | -78.86 |
| 150 | 4/8/2008 | 19:42:59 | -79.19 |

| Point | MEAS Time | | CH 00 |
|-------|-----------|----------|--------|
| | Date | Time | mm |
| 151 | 4/8/2008 | 20:42:59 | -79.5 |
| 152 | 4/8/2008 | 21:42:59 | -79.77 |
| 153 | 4/8/2008 | 22:42:59 | -80.09 |
| 154 | 4/8/2008 | 23:42:59 | -80.38 |
| 155 | 4/9/2008 | 0:42:59 | -80.64 |
| 156 | 4/9/2008 | 1:42:59 | -80.85 |
| 157 | 4/9/2008 | 2:42:59 | -81.12 |
| 158 | 4/9/2008 | 3:42:59 | -81.33 |
| 159 | 4/9/2008 | 4:42:59 | -81.53 |
| 160 | 4/9/2008 | 5:42:59 | -81.8 |
| 161 | 4/9/2008 | 6:42:59 | -81.98 |
| 162 | 4/9/2008 | 7:42:59 | -82.23 |
| 163 | 4/9/2008 | 8:42:59 | -82.4 |
| 164 | 4/9/2008 | 9:42:59 | -82.58 |
| 165 | 4/9/2008 | 10:42:59 | -82.78 |
| 166 | 4/9/2008 | 11:42:59 | -82.93 |
| 167 | 4/9/2008 | 12:42:59 | -83.22 |
| 168 | 4/9/2008 | 13:42:59 | -83.38 |
| 169 | 4/9/2008 | 14:42:59 | -83.51 |
| 170 | 4/9/2008 | 15:42:59 | -83.63 |
| 171 | 4/9/2008 | 16:42:59 | -83.77 |
| 172 | 4/9/2008 | 17:42:59 | -83.86 |
| 173 | 4/9/2008 | 18:42:59 | -83.98 |
| 174 | 4/9/2008 | 19:42:59 | -84.08 |
| 175 | 4/9/2008 | 20:42:59 | -84.18 |
| 176 | 4/9/2008 | 21:42:59 | -84.3 |
| 177 | 4/9/2008 | 22:42:59 | -84.38 |
| 178 | 4/9/2008 | 23:42:59 | -84.51 |
| 179 | 4/10/2008 | 0:42:59 | -84.61 |
| 180 | 4/10/2008 | 1:42:59 | -84.72 |
| 181 | 4/10/2008 | 2:42:59 | -84.81 |
| 182 | 4/10/2008 | 3:42:59 | -84.92 |
| 183 | 4/10/2008 | 4:42:59 | -85 |
| 184 | 4/10/2008 | 5:42:59 | -85.06 |
| 185 | 4/10/2008 | 6:42:59 | -85.13 |
| 186 | 4/10/2008 | 7:42:59 | -85.2 |
| 187 | 4/10/2008 | 8:42:59 | -85.29 |
| 188 | 4/10/2008 | 9:42:59 | -85.45 |
| 189 | 4/10/2008 | 10:42:59 | -85.45 |
| 190 | 4/10/2008 | 11:42:59 | -85.48 |
| 191 | 4/10/2008 | 12:42:59 | -85.69 |
| 192 | 4/10/2008 | 13:42:59 | -85.69 |
| 193 | 4/10/2008 | 14:42:59 | -85.71 |
| 194 | 4/10/2008 | 15:42:59 | -85.76 |
| 195 | 4/10/2008 | 16:42:59 | -85.81 |
| 196 | 4/10/2008 | 17:42:59 | -85.81 |
| 197 | 4/10/2008 | 18:42:59 | -85.99 |
| 198 | 4/10/2008 | 19:42:59 | -86.02 |
| 199 | 4/10/2008 | 20:42:59 | -86.03 |
| 200 | 4/10/2008 | 21:42:59 | -86.06 |

| Point | MEAS Time | | CH 00 mm |
|-------|-----------|----------|-------------|
| | Date | Time | |
| 201 | 4/10/2008 | 22:42:59 | -86.06 |
| 202 | 4/10/2008 | 23:42:59 | -86.13 |
| 203 | 4/11/2008 | 0:42:59 | -86.13 |
| 204 | 4/11/2008 | 1:42:59 | -86.2 |
| 205 | 4/11/2008 | 2:42:59 | -86.19 |
| 206 | 4/11/2008 | 3:42:59 | -86.24 |
| 207 | 4/11/2008 | 4:42:59 | -86.28 |
| 208 | 4/11/2008 | 5:42:59 | -86.32 |
| 209 | 4/11/2008 | 6:42:59 | -86.33 |
| 210 | 4/11/2008 | 7:42:59 | -86.35 |
| 211 | 4/11/2008 | 8:42:59 | -86.41 |
| 212 | 4/11/2008 | 9:42:59 | -86.43 |
| 213 | 4/11/2008 | 10:42:59 | -86.45 |
| 214 | 4/11/2008 | 11:42:59 | -86.49 |
| 215 | 4/11/2008 | 12:42:59 | -86.54 |
| 216 | 4/11/2008 | 13:42:59 | -86.54 |
| 217 | 4/11/2008 | 14:42 | -86.62 |
| 218 | 4/11/2008 | 15:42:59 | -86.61 |
| 219 | 4/11/2008 | 16:42:59 | -86.63 |
| 220 | 4/11/2008 | 17:42:59 | -86.62 |
| 221 | 4/11/2008 | 18:42:59 | -86.64 |
| 222 | 4/11/2008 | 19:42:59 | -86.69 |
| 223 | 4/11/2008 | 20:42:59 | -86.7 |
| 224 | 4/11/2008 | 21:42:59 | -86.75 |
| 225 | 4/11/2008 | 22:42:59 | -86.73 |
| 226 | 4/11/2008 | 23:42:59 | -86.74 |
| 227 | 12-Apr | 0:42:59 | -86.79 |
| 228 | 4/12/2008 | 1:42:59 | -86.76 |
| 229 | 4/12/2008 | 2:42:59 | -86.82 |
| 230 | 4/12/2008 | 3:42:59 | -86.82 |
| 231 | 4/12/2008 | 4:42:59 | -86.82 |
| 232 | 4/12/2008 | 5:42:59 | -86.82 |
| 233 | 4/12/2008 | 6:42:59 | -86.88 |
| 234 | 4/12/2008 | 7:42:59 | -86.89 |
| 235 | 4/12/2008 | 8:42:59 | -86.86 |
| 236 | 4/12/2008 | 9:42:59 | -86.91 |
| 237 | 4/12/2008 | 10:42:59 | -86.91 |
| 238 | 4/12/2008 | 11:42:59 | -86.91 |
| 239 | 4/12/2008 | 12:42:59 | -86.95 |
| 240 | 4/12/2008 | 13:42:59 | -86.99 |
| 241 | 4/12/2008 | 14:42:59 | -87 |
| 242 | 4/12/2008 | 15:42:59 | -86.98 |
| 243 | 4/12/2008 | 16:42:59 | -87.03 |
| 244 | 4/12/2008 | 17:42:59 | -87.03 |
| 245 | 4/12/2008 | 18:42:59 | -87.06 |
| 246 | 4/12/2008 | 19:42:59 | -87.05 |
| 247 | 4/12/2008 | 20:42:59 | -87.06 |
| 248 | 4/12/2008 | 21:42:59 | -87.12 |
| 249 | 4/12/2008 | 22:42:59 | -87.11 |
| 250 | 4/12/2008 | 23:42:59 | -87.07 |

| Point | MEAS Time | | CH 00 mm |
|-------|-----------|----------|-------------|
| | Date | Time | |
| 251 | 4/13/2008 | 0:42:59 | -87.12 |
| 252 | 4/13/2008 | 1:42:59 | -87.11 |
| 253 | 4/13/2008 | 2:42:59 | -87.15 |
| 254 | 4/13/2008 | 3:42:59 | -87.14 |
| 255 | 4/13/2008 | 4:42:59 | -87.16 |
| 256 | 4/13/2008 | 5:42:59 | -87.14 |
| 257 | 4/13/2008 | 6:42:59 | -87.16 |
| 258 | 4/13/2008 | 7:42:59 | -87.18 |
| 259 | 4/13/2008 | 8:42:59 | -87.19 |
| 260 | 4/13/2008 | 9:42:59 | -87.21 |
| 261 | 4/13/2008 | 10:42:59 | -87.21 |
| 262 | 4/13/2008 | 11:42:59 | -87.23 |
| 263 | 4/13/2008 | 12:42:59 | -87.23 |
| 264 | 4/13/2008 | 13:42:59 | -87.23 |
| 265 | 4/13/2008 | 14:42:59 | -87.27 |
| 266 | 4/13/2008 | 15:42:59 | -87.25 |
| 267 | 4/13/2008 | 16:42:59 | -87.31 |
| 268 | 4/13/2008 | 17:42:59 | -87.28 |
| 269 | 4/13/2008 | 18:42:59 | -87.32 |
| 270 | 4/13/2008 | 19:42:59 | -87.32 |
| 271 | 4/13/2008 | 20:42:59 | -87.31 |
| 272 | 4/13/2008 | 21:42:59 | -87.34 |
| 273 | 4/13/2008 | 22:42:59 | -87.34 |
| 274 | 4/13/2008 | 23:42:59 | -87.36 |
| 275 | 4/14/2008 | 0:42:59 | -87.38 |
| 276 | 4/14/2008 | 1:42:59 | -87.38 |
| 277 | 4/14/2008 | 2:42:59 | -87.35 |
| 278 | 4/14/2008 | 3:42:59 | -87.38 |
| 279 | 4/14/2008 | 4:42:59 | -87.39 |
| 280 | 4/14/2008 | 5:42:59 | -87.38 |
| 281 | 4/14/2008 | 6:42:59 | -87.42 |
| 282 | 4/14/2008 | 7:42:59 | -87.43 |
| 283 | 4/14/2008 | 8:42:59 | -87.48 |
| 284 | 4/14/2008 | 9:42:59 | -87.51 |
| 285 | 4/14/2008 | 10:42:49 | -87.53 |
| 286 | 4/14/2008 | 11:42:59 | -87.56 |
| 287 | 4/14/2008 | 12:42:59 | -87.62 |
| 288 | 4/14/2008 | 13:42:59 | -87.63 |
| 289 | 4/14/2008 | 14:42:59 | -87.65 |
| 290 | 4/14/2008 | 15:35:34 | -87.64 |
| 291 | 4/14/2008 | 15:42:59 | -93.68 |
| 292 | 4/14/2008 | 16:42:59 | -93.7 |
| 293 | 4/14/2008 | 17:42:59 | -93.73 |

Table A.4: LVDT Readings (Sand Blanket)

| Point | MEAS Time | | CH 00 |
|-------|-----------|----------|--------|
| | Date | Time | mm |
| 1 | 30/4/2008 | 17:10:18 | -0.002 |
| 2 | 30/4/2008 | 17:11:18 | -0.5 |
| 3 | 30/4/2008 | 17:11:48 | -0.512 |
| 4 | 30/4/2008 | 17:12:18 | -0.675 |
| 5 | 30/4/2008 | 17:12:48 | -0.759 |
| 6 | 30/4/2008 | 17:13:18 | -0.899 |
| 7 | 30/4/2008 | 17:13:48 | -0.925 |
| 8 | 30/4/2008 | 17:14:18 | -0.965 |
| 9 | 30/4/2008 | 17:14:48 | -0.978 |
| 10 | 30/4/2008 | 17:15:18 | -1.003 |
| 11 | 30/4/2008 | 17:15:18 | -1.046 |
| 12 | 30/4/2008 | 17:16:18 | -1.114 |
| 13 | 30/4/2008 | 17:17:18 | -1.125 |
| 14 | 30/4/2008 | 17:18:18 | -1.143 |
| 15 | 30/4/2008 | 17:19:18 | -1.167 |
| 16 | 30/4/2008 | 17:20:18 | -1.245 |
| 17 | 30/4/2008 | 17:21:18 | -1.324 |
| 18 | 30/4/2008 | 17:22:18 | -1.358 |
| 19 | 30/4/2008 | 17:23:18 | -1.398 |
| 20 | 30/4/2008 | 17:24:18 | -1.406 |
| 21 | 30/4/2008 | 17:25:18 | -1.417 |
| 22 | 30/4/2008 | 17:26:18 | -1.422 |
| 23 | 30/4/2008 | 17:27:18 | -1.461 |
| 24 | 30/4/2008 | 17:28:18 | -1.478 |
| 25 | 30/4/2008 | 17:29:18 | -1.498 |
| 26 | 30/4/2008 | 17:30:18 | -1.518 |
| 27 | 30/4/2008 | 17:31:18 | -1.538 |
| 28 | 30/4/2008 | 17:32:18 | -1.557 |
| 29 | 30/4/2008 | 17:33:18 | -1.577 |
| 30 | 30/4/2008 | 17:34:18 | -1.597 |
| 31 | 30/4/2008 | 17:35:18 | -1.617 |
| 32 | 30/4/2008 | 17:36:18 | -1.637 |
| 33 | 30/4/2008 | 17:37:18 | -1.657 |
| 34 | 30/4/2008 | 17:38:18 | -1.677 |
| 35 | 30/4/2008 | 17:39:18 | -1.697 |
| 36 | 30/4/2008 | 17:40:18 | -1.717 |
| 37 | 30/4/2008 | 17:41:18 | -1.737 |
| 38 | 30/4/2008 | 17:42:18 | -1.757 |
| 39 | 30/4/2008 | 17:43:18 | -1.777 |
| 40 | 30/4/2008 | 17:44:18 | -1.797 |
| 41 | 30/4/2008 | 17:45:18 | -1.817 |
| 42 | 30/4/2008 | 17:46:18 | -1.836 |
| 43 | 30/4/2008 | 17:47:18 | -1.856 |
| 44 | 30/4/2008 | 17:48:18 | -1.876 |
| 45 | 30/4/2008 | 17:49:18 | -1.896 |
| 46 | 30/4/2008 | 17:50:18 | -1.916 |
| 47 | 30/4/2008 | 17:51:18 | -1.936 |
| 48 | 30/4/2008 | 17:52:18 | -1.956 |
| 49 | 30/4/2008 | 17:53:18 | -1.976 |
| 50 | 30/4/2008 | 17:54:18 | -1.996 |

| Point | MEAS Time | | CH 00 |
|-------|-----------|----------|--------|
| | Date | Time | mm |
| 51 | 30/4/2008 | 17:55:18 | -6.534 |
| 52 | 30/4/2008 | 17:56:18 | -6.546 |
| 53 | 30/4/2008 | 17:57:18 | -6.897 |
| 54 | 30/4/2008 | 17:58:18 | -7.877 |
| 55 | 30/4/2008 | 17:59:18 | -8.219 |
| 56 | 30/4/2008 | 18:00:18 | -8.452 |
| 57 | 30/4/2008 | 18:01:18 | -9.237 |
| 58 | 30/4/2008 | 18:02:18 | -9.451 |
| 59 | 30/4/2008 | 18:03:18 | -9.98 |
| 60 | 30/4/2008 | 18:04:18 | -10.45 |
| 61 | 30/4/2008 | 18:05:18 | -10.91 |
| 62 | 30/4/2008 | 18:06:18 | -11.37 |
| 63 | 30/4/2008 | 18:07:18 | -11.84 |
| 64 | 30/4/2008 | 18:08:18 | -12.30 |
| 65 | 30/4/2008 | 18:09:18 | -12.76 |
| 66 | 30/4/2008 | 18:10:18 | -13.22 |
| 67 | 30/4/2008 | 18:11:18 | -13.69 |
| 68 | 30/4/2008 | 18:12:18 | -14.15 |
| 69 | 30/4/2008 | 18:13:18 | -14.61 |
| 70 | 30/4/2008 | 18:14:18 | -15.08 |
| 71 | 30/4/2008 | 18:34:18 | -15.54 |
| 72 | 30/4/2008 | 18:54:18 | -16.00 |
| 73 | 30/4/2008 | 19:14:18 | -16.46 |
| 74 | 30/4/2008 | 19:34:18 | -16.93 |
| 75 | 30/4/2008 | 19:54:18 | -17.39 |
| 76 | 30/4/2008 | 20:14:18 | -17.85 |
| 77 | 30/4/2008 | 20:34:18 | -18.32 |
| 78 | 30/4/2008 | 20:54:18 | -18.78 |
| 79 | 30/4/2008 | 21:14:18 | -19.24 |
| 80 | 30/4/2008 | 21:34:18 | -19.70 |
| 81 | 30/4/2008 | 21:54:18 | -20.17 |
| 82 | 30/4/2008 | 22:14:18 | -20.63 |
| 83 | 30/4/2008 | 22:34:18 | -21.09 |
| 84 | 30/4/2008 | 22:54:18 | -21.56 |
| 85 | 30/4/2008 | 23:14:18 | -22.02 |
| 86 | 30/4/2008 | 23:34:18 | -22.48 |
| 87 | 30/4/2008 | 23:54:18 | -22.94 |
| 88 | 1/5/2008 | 0:14:18 | -23.41 |
| 89 | 1/5/2008 | 0:34:18 | -23.87 |
| 90 | 1/5/2008 | 0:54:18 | -24.33 |
| 91 | 1/5/2008 | 1:14:18 | -24.80 |
| 92 | 1/5/2008 | 1:34:18 | -25.26 |
| 93 | 1/5/2008 | 1:54:18 | -25.72 |
| 94 | 1/5/2008 | 2:14:18 | -26.18 |
| 95 | 1/5/2008 | 2:34:18 | -26.65 |
| 96 | 1/5/2008 | 2:54:18 | -27.11 |
| 97 | 1/5/2008 | 3:14:18 | -27.57 |
| 98 | 1/5/2008 | 3:34:18 | -28.04 |
| 99 | 1/5/2008 | 3:54:18 | -28.50 |
| 100 | 1/5/2008 | 4:14:18 | -28.96 |

| Point | MEAS Time | | CH 00 |
|-------|-----------|----------|--------|
| | Date | Time | mm |
| 101 | 1/5/2008 | 4:34:18 | -29.23 |
| 102 | 1/5/2008 | 4:54:18 | -29.64 |
| 103 | 1/5/2008 | 5:14:18 | -29.76 |
| 104 | 1/5/2008 | 5:34:18 | -30.21 |
| 105 | 1/5/2008 | 5:54:18 | -30.25 |
| 106 | 1/5/2008 | 6:14:18 | -30.48 |
| 107 | 1/5/2008 | 6:34:18 | -30.76 |
| 108 | 1/5/2008 | 6:54:18 | -31.03 |
| 109 | 1/5/2008 | 7:14:18 | -31.26 |
| 110 | 1/5/2008 | 7:34:18 | -31.51 |
| 111 | 1/5/2008 | 7:54:18 | -31.75 |
| 112 | 1/5/2008 | 8:14:18 | -31.99 |
| 113 | 1/5/2008 | 8:34:18 | -32.23 |
| 114 | 1/5/2008 | 8:54:18 | -32.48 |
| 115 | 1/5/2008 | 9:14:18 | -32.72 |
| 116 | 1/5/2008 | 9:34:18 | -32.96 |
| 117 | 1/5/2008 | 9:54:18 | -33.21 |
| 118 | 1/5/2008 | 10:14:18 | -33.45 |
| 119 | 1/5/2008 | 10:34:18 | -33.69 |
| 120 | 1/5/2008 | 10:54:18 | -33.93 |
| 121 | 1/5/2008 | 11:14:18 | -34.18 |
| 122 | 1/5/2008 | 11:34:18 | -34.42 |
| 123 | 1/5/2008 | 11:54:18 | -34.66 |
| 124 | 1/5/2008 | 12:14:18 | -34.91 |
| 125 | 1/5/2008 | 12:34:18 | -35.15 |
| 126 | 1/5/2008 | 12:54:18 | -35.39 |
| 127 | 1/5/2008 | 13:14:18 | -35.63 |
| 128 | 1/5/2008 | 13:34:18 | -35.88 |
| 129 | 1/5/2008 | 13:54:18 | -36.12 |
| 130 | 1/5/2008 | 14:14:18 | -36.36 |
| 131 | 1/5/2008 | 14:34:18 | -36.61 |
| 132 | 1/5/2008 | 14:54:18 | -36.85 |
| 133 | 1/5/2008 | 15:14:18 | -37.09 |
| 134 | 1/5/2008 | 15:34:18 | -37.33 |
| 135 | 1/5/2008 | 15:54:18 | -37.58 |
| 136 | 1/5/2008 | 16:14:18 | -37.82 |
| 137 | 1/5/2008 | 16:34:18 | -38.06 |
| 138 | 1/5/2008 | 16:54:18 | -38.31 |
| 139 | 1/5/2008 | 17:14:18 | -38.55 |
| 140 | 1/5/2008 | 17:34:18 | -38.79 |
| 141 | 1/5/2008 | 17:34:18 | -39.03 |
| 142 | 1/5/2008 | 18:34:18 | -39.28 |
| 143 | 1/5/2008 | 19:34:18 | -39.52 |
| 144 | 1/5/2008 | 20:34:18 | -39.76 |
| 145 | 1/5/2008 | 21:34:18 | -40.01 |
| 146 | 1/5/2008 | 22:34:18 | -40.25 |
| 147 | 1/5/2008 | 23:34:18 | -40.49 |
| 148 | 2/5/2008 | 0:34:18 | -40.73 |
| 149 | 2/5/2008 | 1:34:18 | -40.98 |
| 150 | 2/5/2008 | 2:34:18 | -41.22 |

| Point | MEAS Time | | CH 00 |
|-------|-----------|----------|--------|
| | Date | Time | mm |
| 151 | 2/5/2008 | 3:34:18 | -41.43 |
| 152 | 2/5/2008 | 4:34:18 | -41.67 |
| 153 | 2/5/2008 | 5:34:18 | -41.99 |
| 154 | 2/5/2008 | 6:34:18 | -42.11 |
| 155 | 2/5/2008 | 7:34:18 | -42.26 |
| 156 | 2/5/2008 | 8:34:18 | -42.56 |
| 157 | 2/5/2008 | 9:34:18 | -42.76 |
| 158 | 2/5/2008 | 10:34:18 | -42.97 |
| 159 | 2/5/2008 | 11:34:18 | -43.19 |
| 160 | 2/5/2008 | 12:34:18 | -43.40 |
| 161 | 2/5/2008 | 13:34:18 | -43.62 |
| 162 | 2/5/2008 | 14:34:18 | -43.83 |
| 163 | 2/5/2008 | 15:34:18 | -44.05 |
| 164 | 2/5/2008 | 16:34:18 | -44.27 |
| 165 | 2/5/2008 | 17:34:18 | -44.48 |
| 166 | 2/5/2008 | 18:34:18 | -44.70 |
| 167 | 2/5/2008 | 19:34:18 | -44.91 |
| 168 | 2/5/2008 | 20:34:18 | -45.13 |
| 169 | 2/5/2008 | 21:34:18 | -45.34 |
| 170 | 2/5/2008 | 22:34:18 | -45.56 |
| 171 | 2/5/2008 | 23:34:18 | -45.77 |
| 172 | 3/5/2008 | 0:34:18 | -45.99 |
| 173 | 3/5/2008 | 1:34:18 | -46.20 |
| 174 | 3/5/2008 | 2:34:18 | -46.42 |
| 175 | 3/5/2008 | 3:34:18 | -46.64 |
| 176 | 3/5/2008 | 4:34:18 | -46.85 |
| 177 | 3/5/2008 | 5:34:18 | -47.07 |
| 178 | 3/5/2008 | 6:34:18 | -47.28 |
| 179 | 3/5/2008 | 7:34:18 | -47.50 |
| 180 | 3/5/2008 | 8:34:18 | -47.71 |
| 181 | 3/5/2008 | 9:34:18 | -47.93 |
| 182 | 3/5/2008 | 10:34:18 | -48.14 |
| 183 | 3/5/2008 | 11:34:18 | -48.36 |
| 184 | 3/5/2008 | 12:34:18 | -48.57 |
| 185 | 3/5/2008 | 13:34:18 | -48.79 |
| 186 | 3/5/2008 | 14:34:18 | -49.00 |
| 187 | 3/5/2008 | 15:34:18 | -49.22 |
| 188 | 3/5/2008 | 16:34:18 | -49.44 |
| 189 | 3/5/2008 | 17:34:18 | -49.65 |
| 190 | 3/5/2008 | 18:34:18 | -49.87 |
| 191 | 3/5/2008 | 19:34:18 | -50.08 |
| 192 | 3/5/2008 | 20:34:18 | -50.30 |
| 193 | 3/5/2008 | 21:34:18 | -50.51 |
| 194 | 3/5/2008 | 22:34:18 | -50.73 |
| 195 | 3/5/2008 | 23:34:18 | -50.94 |
| 196 | 4/5/2008 | 0:34:18 | -51.16 |
| 197 | 4/5/2008 | 1:34:18 | -51.37 |
| 198 | 4/5/2008 | 2:34:18 | -51.59 |
| 199 | 4/5/2008 | 3:34:18 | -51.81 |
| 200 | 4/5/2008 | 4:34:18 | -52.02 |

| Point | MEAS Time | | CH 00 |
|-------|-----------|----------|--------|
| | Date | Time | mm |
| 201 | 4/5/2008 | 5:34:18 | -52.30 |
| 202 | 4/5/2008 | 6:34:18 | -52.35 |
| 203 | 4/5/2008 | 7:34:18 | -52.41 |
| 204 | 4/5/2008 | 8:34:18 | -52.41 |
| 205 | 4/5/2008 | 9:34:18 | -52.47 |
| 206 | 4/5/2008 | 10:34:18 | -52.50 |
| 207 | 4/5/2008 | 11:34:18 | -52.54 |
| 208 | 4/5/2008 | 12:34:18 | -52.58 |
| 209 | 4/5/2008 | 13:34:18 | -52.62 |
| 210 | 4/5/2008 | 14:34:18 | -52.66 |
| 211 | 4/5/2008 | 15:34:18 | -52.70 |
| 212 | 4/5/2008 | 16:34:18 | -52.74 |
| 213 | 4/5/2008 | 17:34:18 | -52.78 |
| 214 | 4/5/2008 | 18:34:18 | -52.82 |
| 215 | 4/5/2008 | 19:34:18 | -52.86 |
| 216 | 4/5/2008 | 20:34:18 | -52.89 |
| 217 | 4/5/2008 | 21:34:18 | -52.93 |
| 218 | 4/5/2008 | 22:34:18 | -52.97 |
| 219 | 4/5/2008 | 23:34:18 | -52.97 |
| 220 | 5/5/2008 | 0:34:18 | -52.98 |
| 221 | 5/5/2008 | 1:34:18 | -53.01 |
| 222 | 5/5/2008 | 2:34:18 | -53.01 |
| 223 | 5/5/2008 | 3:34:18 | -53.17 |
| 224 | 5/5/2008 | 4:34:18 | -53.19 |
| 225 | 5/5/2008 | 5:34:18 | -53.21 |
| 226 | 5/5/2008 | 6:34:18 | -53.42 |
| 227 | 5/5/2008 | 7:34:18 | -53.48 |
| 228 | 5/5/2008 | 8:34:18 | -53.54 |
| 229 | 5/5/2008 | 9:34:18 | -53.61 |
| 230 | 5/5/2008 | 10:34:18 | -53.73 |
| 231 | 5/5/2008 | 11:34:18 | -53.82 |
| 232 | 5/5/2008 | 12:34:18 | -54.18 |
| 233 | 5/5/2008 | 13:34:18 | -54.54 |
| 234 | 5/5/2008 | 14:34:18 | -54.90 |
| 235 | 5/5/2008 | 15:34:18 | -55.25 |
| 236 | 5/5/2008 | 16:34:18 | -55.26 |
| 237 | 5/5/2008 | 17:34:18 | -55.31 |
| 238 | 5/5/2008 | 18:34:18 | -55.33 |
| 239 | 5/5/2008 | 19:34:18 | -55.33 |
| 240 | 5/5/2008 | 20:34:18 | -55.43 |
| 241 | 5/5/2008 | 21:34:18 | -55.43 |
| 242 | 5/5/2008 | 22:34:18 | -55.45 |
| 243 | 5/5/2008 | 23:34:18 | -55.45 |
| 244 | 6/5/2008 | 0:34:18 | -55.46 |
| 245 | 6/5/2008 | 1:34:18 | -55.46 |
| 246 | 6/5/2008 | 2:34:18 | -55.47 |
| 247 | 6/5/2008 | 3:34:18 | -55.47 |
| 248 | 6/5/2008 | 4:34:18 | -55.47 |
| 249 | 6/5/2008 | 5:34:18 | -55.48 |
| 250 | 6/5/2008 | 6:34:18 | -55.54 |

| Point | MEAS Time | | CH 00 |
|-------|-----------|----------|--------|
| | Date | Time | mm |
| 251 | 6/5/2008 | 7:34:18 | -55.54 |
| 252 | 6/5/2008 | 8:34:18 | -55.41 |
| 253 | 6/5/2008 | 9:34:18 | -55.41 |
| 254 | 6/5/2008 | 10:34:18 | -55.43 |
| 255 | 6/5/2008 | 11:34:18 | -55.47 |
| 256 | 6/5/2008 | 12:34:18 | -55.47 |
| 257 | 6/5/2008 | 13:34:18 | -55.51 |
| 258 | 6/5/2008 | 14:34:18 | -55.53 |
| 259 | 6/5/2008 | 15:34:18 | -55.56 |
| 260 | 6/5/2008 | 16:34:18 | -55.56 |
| 261 | 6/5/2008 | 17:34:18 | -55.63 |
| 262 | 6/5/2008 | 18:34:18 | -55.63 |
| 263 | 6/5/2008 | 19:34:18 | -55.63 |
| 264 | 6/5/2008 | 20:34:18 | -55.70 |
| 265 | 6/5/2008 | 21:34:18 | -55.71 |
| 266 | 6/5/2008 | 22:34:18 | -55.72 |
| 267 | 6/5/2008 | 23:34:18 | -55.85 |
| 268 | 7/5/2008 | 0:34:18 | -55.85 |
| 269 | 7/5/2008 | 1:34:18 | -56.03 |
| 270 | 7/5/2008 | 2:34:18 | -56.03 |
| 271 | 7/5/2008 | 3:34:18 | -56.35 |
| 272 | 7/5/2008 | 4:34:18 | -56.35 |
| 273 | 7/5/2008 | 5:34:18 | -56.47 |
| 274 | 7/5/2008 | 6:34:18 | -56.54 |
| 275 | 7/5/2008 | 7:34:18 | -56.54 |
| 276 | 7/5/2008 | 8:34:18 | -56.67 |
| 277 | 7/5/2008 | 9:34:18 | -56.67 |
| 278 | 7/5/2008 | 10:34:18 | -57.12 |
| 279 | 7/5/2008 | 11:34:18 | -57.24 |
| 280 | 7/5/2008 | 12:34:18 | -57.82 |
| 281 | 7/5/2008 | 13:34:18 | -57.82 |
| 282 | 7/5/2008 | 14:34:18 | -57.82 |
| 283 | 7/5/2008 | 15:34:18 | -57.84 |
| 284 | 7/5/2008 | 16:34:18 | -57.84 |
| 285 | 7/5/2008 | 17:34:18 | -57.84 |

APPENDIX 3

Table A.5: Discharge Capacity (Stripdrain[™])

| Discharge Capacity (Day 1) | | | |
|----------------------------|----------|----------|----------------|
| | | Time | Discharge (ml) |
| 1 | 7/4/2008 | 10:18:00 | 0 |
| 2 | 7/4/2008 | 10:18:30 | 420 |
| 3 | 7/4/2008 | 10:19:00 | 430 |
| 4 | 7/4/2008 | 10:19:30 | 450 |
| 5 | 7/4/2008 | 10:20:00 | 460 |
| 6 | 7/4/2008 | 10:20:30 | 490 |
| 7 | 7/4/2008 | 10:21:00 | 500 |
| 8 | 7/4/2008 | 10:21:30 | 510 |
| 9 | 7/4/2008 | 10:22:00 | 520 |
| 10 | 7/4/2008 | 10:22:30 | 530 |
| 11 | 7/4/2008 | 10:23:00 | 540 |
| 12 | 7/4/2008 | 10:23:30 | 550 |
| 13 | 7/4/2008 | 10:24:00 | 560 |
| 14 | 7/4/2008 | 10:24:30 | 570 |
| 15 | 7/4/2008 | 10:25:00 | 580 |
| 16 | 7/4/2008 | 10:25:30 | 590 |
| 17 | 7/4/2008 | 10:26:00 | 600 |
| 18 | 7/4/2008 | 10:26:30 | 610 |
| 19 | 7/4/2008 | 10:27:00 | 620 |
| 20 | 7/4/2008 | 10:27:30 | 700 |
| 21 | 7/4/2008 | 10:28:00 | 710 |
| 22 | 7/4/2008 | 10:33:00 | 780 |
| 23 | 7/4/2008 | 10:35:00 | 860 |
| 24 | 7/4/2008 | 10:40:00 | 910 |
| 25 | 7/4/2008 | 10:45:00 | 930 |
| 26 | 7/4/2008 | 10:50:00 | 1020 |
| 27 | 7/4/2008 | 10:55:00 | 1130 |
| 28 | 7/4/2008 | 11:00:00 | 1200 |
| 29 | 7/4/2008 | 11:05:00 | 1280 |
| 30 | 7/4/2008 | 11:10:00 | 1320 |
| 31 | 7/4/2008 | 11:15:00 | 1360 |
| 32 | 7/4/2008 | 11:20:00 | 1420 |
| 33 | 7/4/2008 | 11:25:00 | 1460 |
| 34 | 7/4/2008 | 11:30:00 | 1560 |
| 35 | 7/4/2008 | 11:35:00 | 1630 |
| 36 | 7/4/2008 | 11:40:00 | 1690 |
| 37 | 7/4/2008 | 11:45:00 | 1730 |
| 38 | 7/4/2008 | 11:50:00 | 2000 |
| 39 | 7/4/2008 | 11:55:00 | 2040 |
| 40 | 7/4/2008 | 12:00:00 | 2080 |
| 41 | 7/4/2008 | 13:00:00 | 2520 |
| 42 | 7/4/2008 | 14:00:00 | 2880 |
| 43 | 7/4/2008 | 15:00:00 | 3160 |
| 44 | 7/4/2008 | 16:00:00 | 3400 |
| 45 | 7/4/2008 | 17:00:00 | 3580 |
| 46 | 7/4/2008 | 18:00:00 | 3880 |

Discharge Capacity (Day 2)

| | | Time | Discharge (ml) |
|---|----------|----------|----------------|
| 1 | 8/4/2008 | 10:00:00 | 5680 |
| 2 | 8/4/2008 | 14:00:00 | 5780 |
| 3 | 8/4/2008 | 16:00:00 | 5840 |

Discharge Capacity (Day 3)

| | | | |
|---|----------|----------|------|
| 1 | 9/4/2008 | 10:00:00 | 6520 |
| 2 | 9/4/2008 | 16:00:00 | 6540 |

Discharge Capacity (Day 4)

| | | | |
|---|-----------|----------|------|
| 1 | 10/4/2008 | 10:00:00 | 6720 |
| 2 | 10/4/2008 | 16:00:00 | 6720 |

Discharge Capacity (Day 5)

| | | | |
|---|-----------|----------|------|
| 1 | 11/4/2008 | 10:00:00 | 6720 |
| 2 | 11/4/2008 | 16:00:00 | 6720 |

* No reading on 12th and 13th April 2008 - Weekend)

Discharge Capacity (Day 8)

| | | | |
|---|-----------|----------|------|
| 1 | 14/4/2008 | 10:00:00 | 6720 |
|---|-----------|----------|------|

Table A.6: Discharge Capacity (Sand Blanket)

Discharge Capacity(Day 1)

| | | Time | Discharge (ml) |
|---|-----------|----------|----------------|
| 1 | 30.4.2008 | 17:10:00 | 0 |
| 2 | 30.4.2008 | 17:20:00 | 0 |
| 3 | 30.4.2008 | 17:30:00 | 0 |
| 4 | 30.4.2008 | 17:40:00 | 0 |
| 5 | 30.4.2008 | 17:50:00 | 0 |
| 6 | 30.4.2008 | 18:00:00 | 110 |

Discharge Capacity (Day 2)

| | | Time | Discharge (ml) |
|---|----------|----------|----------------|
| 1 | 1.5.2008 | 9:00:00 | 1480 |
| 2 | 1.5.2008 | 12:00:00 | 1600 |
| 3 | 1.5.2008 | 15:00:00 | 2020 |
| 4 | 1.5.2008 | 18:00:00 | 2410 |

Discharge Capacity (Day 3)

| | | Time | Discharge (ml) |
|---|----------|----------|----------------|
| 1 | 2.5.2008 | 9:00:00 | 3650 |
| 2 | 2.5.2008 | 12:00:00 | 3690 |
| 3 | 2.5.2008 | 15:00:00 | 3740 |
| 4 | 2.5.2008 | 18:00:00 | 3810 |

*No reading on 3rd and 4th May 2008 -
Weekend)

Discharge Capacity (Day 6)

| | | Time | Discharge (ml) |
|---|----------|----------|----------------|
| 1 | 5.5.2008 | 9:00:00 | 5000 |
| 2 | 5.5.2008 | 12:00:00 | 5100 |
| 3 | 5.5.2008 | 15:00:00 | 5100 |
| 4 | 5.5.2008 | 18:00:00 | 5320 |

Discharge Capacity (Day 7)

| | | Time | Discharge (ml) |
|---|----------|----------|----------------|
| 1 | 6.5.2008 | 9:00:00 | 5410 |
| 2 | 6.5.2008 | 12:00:00 | 5500 |
| 3 | 6.5.2008 | 15:00:00 | 5550 |
| 4 | 6.5.2008 | 18:00:00 | 5600 |

Discharge Capacity (Day 8)

| | | Time | Discharge (ml) |
|---|----------|----------|----------------|
| 1 | 7.5.2008 | 9:00:00 | 5600 |
| 2 | 7.5.2008 | 12:00:00 | 5600 |
| 3 | 7.5.2008 | 15:00:00 | 5600 |
| 4 | 7.5.2008 | 18:00:00 | 5600 |