

CHAPTER 2

LITERATURE REVIEW

2.1 Introduction

This Chapter presents a review of available and related published literature on geopolymer concrete and SCC, serving the purpose of general introduction of these materials as well as establishing the foundation to this thesis. The first part of the chapter focuses on geopolymer concrete. This includes the geopolymer terminology, geopolymerization mechanism, materials used to produce geopolymer concrete and the existing knowledge on the mechanical properties of the geopolymer concrete. The second part of the chapter reviews literature about SCC. This includes the fresh properties, testing methods to evaluate the fresh properties and the mechanical properties of SCC. The history of development and composition of SCC are also briefly reviewed in this part of the chapter.

2.2 Geopolymer Concrete

In view of the issues of energy consumption and CO₂ emission raised about the cement industry, it is now believed that new binders are indispensable to completely replace the traditional Portland cement in concrete production. The development of new cements other than Portland cements using large amounts of wastes as raw material is an ongoing study and research topic of the scientific community. Since past few decades, industrial by-product and agricultural waste materials have been introduced into the construction industry to partially replace the OPC. These waste materials which contain sufficient amount of silicon and aluminium oxides when react with an alkaline solution forms a binder similar to the Portland cement. This innovative binder material is termed as geopolymer concrete.

Geopolymeric materials are promising materials and have been considered as the cements of the future due to their low ecological impact and relatively high yield from raw materials. From an environmental point of view, one of the primary advantages of geopolymers over traditional cements is the considerably low amount of CO₂ emission rate from geopolymer production than OPC. The production of Portland cement leads to release significant amount of CO₂ and other greenhouse gases in to the atmosphere as a result of decarbonation of limestone and the combustion of fossil fuels. In contrast, the production of raw materials for geopolymers does not require a high level of energy consumption as high temperature calcining is not required. This results to a significant reduction in the energy consumption and CO₂ emission [1, 6].

Geopolymer concretes are prospective concretes, which possess remarkable physico-chemical and mechanical properties. Depending on the raw material selection and processing conditions, geopolymer concrete can exhibit a wide variety of valuable characteristics than the traditional Portland cement concrete. Geopolymer concretes are known to exhibit excellent performance with respect to fire resistance, acid resistance, show rapid hardening, high and early compressive strength, and low creep and drying shrinkage. These unique properties make geopolymer concrete a strong candidate as a substitute for Portland cement concrete. Thus, the use of geopolymer technology not only substantially reduces the CO₂ emissions by cement industries, but also utilises the industrial wastes and/or by-products of alumino-silicate composition to produce added-value construction materials [13].

2.2.1 Geopolymers: History and background

The term geopolymer was first introduced in 1978 by Joseph Davidovits to describe the inorganic polymers based on alumino-silicates and can be produced by synthesizing pozzolanic compounds or alumino-silicate source materials with highly alkaline solutions [14]. He proposed that an alkaline liquid could be used to react with Silicon (Si) and Aluminum (Al) present in the source material of geological origin or by-product materials to produce binders. As the binder produced in this case is due to the polymerization process, Davidovits [15] termed these binders as geopolymers.

Geopolymers belongs to the family of inorganic polymers, and are a chain structures formed on a backbone of Al and Si ions. According to Davidovits [16], the geopolymer consist of polymeric Si-O-Al framework, with SiO_4 and AlO_4 tetrahedrally interlinked alternately by sharing all the oxygen atoms. In order to better describe the molecular structures of geopolymers, the term polysialate was coined as a descriptor of the silico-aluminate structure, Sialate being an abbreviation for silicon-oxo-aluminate. Polysialates are chain and ring polymers with Si^{4+} and Al^{3+} in IV-fold coordination with oxygen and range from amorphous to semi-crystalline [6]. Based on the chemical combinations of these molecules, the designations poly(sialate), poly(sialate-siloxo) and poly(sialate-disiloxo) were defined. According to Davidovits, a geopolymer can take one of the following three basic forms outlined in Table 2.1 [14]. The structures of these polysialates can be schematised as in Figure 2.1.

Table 2.1 Davidovits's proposed Geopolymer Designations [14]

Name	Abbreviation	Chemical Structure
Poly(Sialate)	PS	$[-\text{Si}-\text{O}-\text{Al}-\text{O}]$
Poly(Sialate-siloxo)	PSS	$[-\text{Si}-\text{O}-\text{Al}-\text{O}-\text{Si}-\text{O}]$
Poly(Sialate-disiloxo)	PSDS	$[-\text{Si}-\text{O}-\text{Al}-\text{O}-\text{Si}-\text{O}-\text{Si}-\text{O}]$

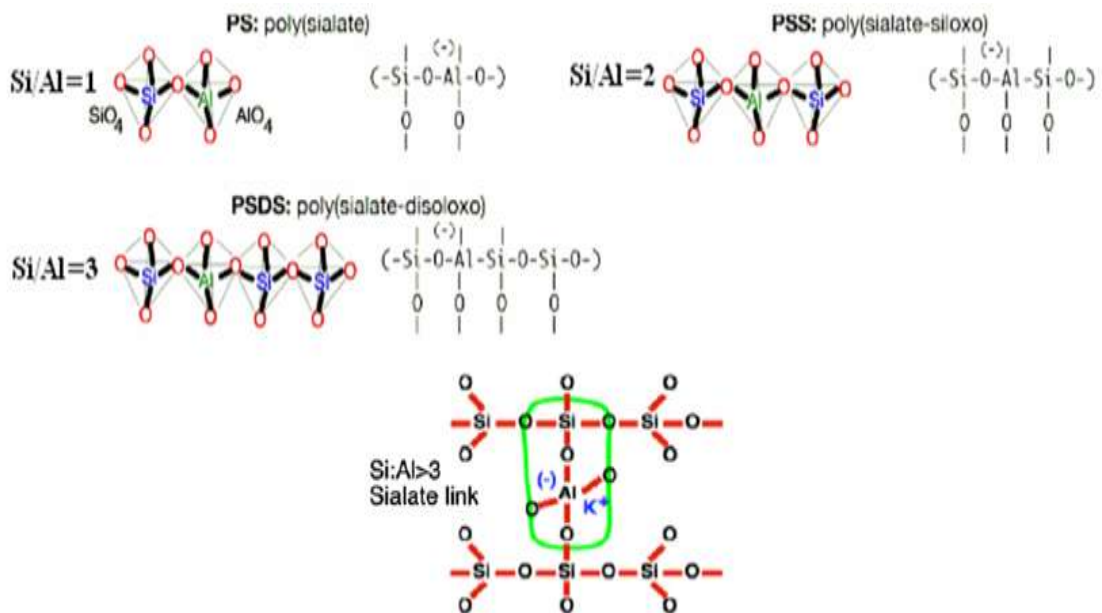

Figure 2.1 Three Basic Forms of Geopolymer [15]

Geopolymers are totally different from OPC, as these materials use a different reaction pathway in order to attain structural integrity. Unlike OPC, geopolymers do

not form calcium-silicate-hydrates (CSH) for matrix formation and strength. Instead, geopolymers utilize the polycondensation of silica and alumina precursors and a high alkali content to attain structural strength [17]. Figure 2.2 shows the reaction mechanism of geopolymer and normal cement-based concrete.

Geopolymers are also referred to as alkali-activated cements, geocements and inorganic polymer concretes. Despite this variety of the names available in literature, these all terms describe materials synthesized utilizing the same chemistry and are produced by using the aluminosilicate based source materials in a highly alkaline solution [18].

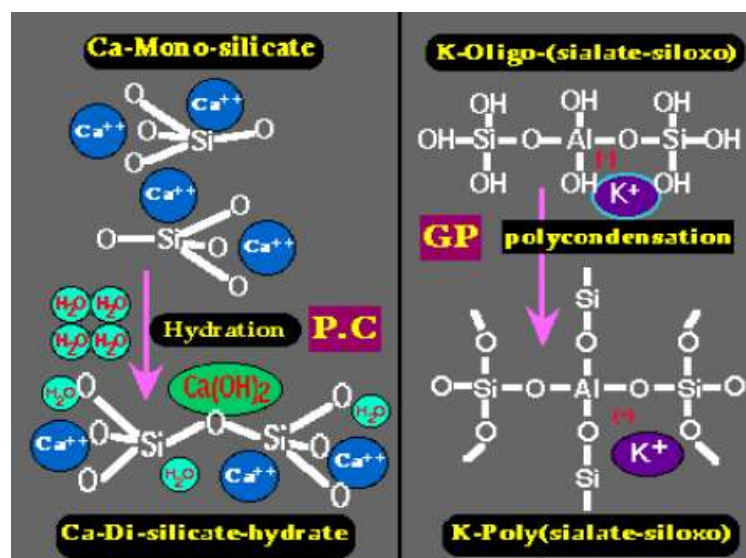

Figure 2.2 Reaction Mechanism of Geopolymer and Cement-based Concretes [15]

2.2.2 Geopolymer Science

The geopolymerization process is an exothermic polycondensation reaction involving alkali activation by a cation presents in solution. The geopolymerization process depends on many parameters including the chemical and mineralogical composition of the starting materials, the Si/Al molar ratio, curing temperature, water content, and concentration of the alkaline compound [19, 20].

In polymerization relatively small molecules, called monomers, combine chemically to produce a very large chain like or network molecule, called a polymer.

The polymerization process involves a substantially fast chemical reaction between solid alumino-silicate oxides (Si_2O_5 , Al_2O_2) and alkali polysilicates under highly alkaline conditions yielding amorphous to semi-crystalline three-dimensional polymeric chain and ring structures, which consist of Si-O-Al bonds. Polysilicates are generally sodium or potassium silicate [19]. To describe the chemical composition, the geopolymers are expressed by the following empirical formula:



Where, ‘M’ is an alkaline element or cation such as potassium, sodium or calcium used to activate the reaction; the symbol – indicates the presence of a bond; n is the degree of polycondensation or polymerization, z is 1,2,3, or higher, up to 32 and w is the amount of binding water [14, 15].

Various efforts have been made to understand the chemistry of geopolymer formation. Since the innovation of geopolymer, despite of the intense research on the geopolymerization of different alumino-silicate based materials and the development of a wide range of geopolymeric materials, to date, the exact mechanism of setting and hardening of the geopolymer material is not fully understood. However, it is believed that the most proposed mechanism for geopolymerization may comprise the following three steps [19, 21].

- Dissolution of Si and Al atoms from the alumino-silicate source material in the strongly alkaline solution through the action of hydroxide ions.
- Diffusion or transportation or condensation of precursor ions into monomers.
- Setting or polycondensation/polymerization of monomers into solid inorganic polymeric structures.

Dissolution of the source materials is the main step that performs double role. Initially, polysialate forming species are released from the source materials in a similar manner as in the formation of zeolite precursors. Afterwards, dissolution activates the surface and binding reactions take place contributing substantially to the final strength of the structure [18]. As the formation rate of geopolymer is very rapid, the different steps involved in the formation of geopolymer can overlap with each

other and occur almost simultaneously, thus making it difficult to isolate and examine each of them separately [19, 21].

2.3 Constituents of Geopolymer Concrete

Apart from the coarse and fine aggregates used in conventional concrete, the two main constituents of geopolymer concrete are the source materials and the alkaline solutions. Source materials based on alumino-silicates containing aluminum in IV-Fold coordination are necessary for the alkali activation of geopolymer products [22]. The alumino-silicate based source material and the alkaline activator have direct effect on final product of geopolymers [23]. Properties of the source material affects the dissolution process and the subsequent reaction while the alkaline activators partially or completely dissolve the solid alumino-silicate material and determine break and recombination of the alumino-silicate structure, polycondensation and charge balance in the reaction system [23].

2.3.1 Source Materials

Geopolymeric materials can be produced from natural raw materials or industrial by-products that have a rich alumino-silicate composition [24]. Any pozzolanic compound or material that contains predominantly Si and Al in amorphous form and is readily dissolved in the alkaline solution is a possible source material for the manufacture of geopolymers [21]. The source material used for geopolymerization can be a single material or a combination of various types of materials [25]. The choice of the source materials for producing geopolymers however depends on many factors such as availability, cost, type of application, and specific demand of the end users. Wide range of materials has been investigated for the synthesis of geopolymers. Among the potential alumino-silicate based materials, materials such as coal fly ash, metakaolin, ground granulated blast-furnace slag and silica fume are the most widely used materials. However, a detailed description of only fly ash and silica fume is given in the following sub-sections, as these materials were utilized in the present study.

2.3.1.1 Fly Ash

Fly ash, also known as pulverized fuel ash, is the finely divided mineral residue that results from the combustion of pulverized coal in electric power generating plants [26]. During the combustion of pulverized coal, most of the volatile matter and carbon in the coal are burned off. The mineral matter associated with the coal disintegrates to varying degrees and the mineral impurities (such as clay, feldspar, quartz, and shale) are carried off in the form of ash by the exhaust gases. The coarser portion of the coal ash which is heavy falls to the bottom of the furnace, and thus is collected as bottom ash. The finer particles that carried upwards with the flue gases are collected as fly ash by using a series of mechanical separators followed by highly efficient electrostatic precipitators or bag filters [26, 27]. Fly ash because of its mineralogical composition, fine particle size and glassy nature, is generally pozzolanic. Because of fineness and pozzolanic properties, fly ash is widely accepted as useful cement replacement material in various concrete applications [26].

- **Classification of Fly ash**

Fly ash is generally classified as Class F fly ash and Class C fly ash. The main difference between the two classes of fly ash is the amount of calcium oxide content and the sum of silica, alumina, and iron oxides in the ash. There are the other physical and chemical requirements for the inclusion of an ash into a specific class. Table 2.2 shows the requirements for Class C and Class F fly ashes for use in Portland cement concrete as per ASTM C 618 [28].

Although Class F and Class C designations strictly apply only to fly ash meeting the ASTM C 618 specification [28], however, these terms are often used more generally to apply to fly ash on the basis of its original coal type or calcium oxide content. Class F fly ash is poor in CaO and MgO compared to Class C fly ash. Class F fly ashes generally contain less than 10% CaO. In contrast, Class C fly ashes contain more than 20% CaO. Another difference between Class F and Class C fly ashes is that the amount of alkalis and sulfates are generally higher in the Class C fly ashes than in the Class F fly ashes. Class F fly ashes invariably contain more than 3% unburned

carbon and consists mostly of an aluminosilicate glass, and generally do not contain any crystalline compounds of calcium. On the other hand, Class C fly ashes have very little unburned carbon and consist mostly of calcium aluminosulphate glass, as well as a substantial amount of crystalline compounds of calcium [26, 27].

Table 2.2 Requirements for Class F and Class C Fly ashes for use in Portland cement Concrete as per ASTM C 618-05 [28]

Requirements		Class F	Class C
Chemical Requirements			
SiO ₂ + Al ₂ O ₃ + Fe ₂ O ₃	Min. %	70	50
SO ₃	Max. %	5	5
Moisture Content	Max. %	3	3
Loss on Ignition (LOI)	Max. %	6	6
Physical Requirements			
Amount retained when wet sieved on 45µm sieve	Max. %	34	34
Pozzolanic Activity Index, with portland cement, at 28 days	Min. %	75	75
Pozzolanic Activity index, with lime, at 7 days	Min. %	75	75
Water Requirement	Max. %	105	105
Autoclave Expansion or contraction	Max. %	0.8	0.8
Specific gravity	Max. %	5	5
Percent retained on 45µm sieve	Max. %	5	5
Optional Physical Requirements			
Available Alkalies as Na ₂ O	Max. %	1.5	1.5
Increase in drying shrinkage	Max. %	0.03	0.03
Air entraining required for air content of 18.0 volume %	Max. %	20	20
Mortar Expansion at 14 days in alkali reactivity test	Max. %	0.02	0.02

- **Characteristics of Fly ash**

Fly ash generated in coal burning power plants is an inherently variable by-product material with a highly variable physical characteristics and chemical composition [26]. The characteristics of fly ash are greatly influenced by various factors such as the type and mineralogical composition of the feed coal, degree of coal pulverization, conditions during combustion, additives used to assist combustion or post combustion

processes and the manner in which fly ash is collected, handled and stored [27]. As power generating plants burn large volumes of coal from multiple sources, fly ash from various power plants is likely to be different.

(a) Physical Characteristics

Fly ash consists of very fine powdery particles, predominantly spherical in shape, either solid or hollow and mostly glassy (amorphous) in nature (Figure 2.3). Fly ash is generally finer than Portland cement and the particle size vary from 0.5 μm to 100 μm with typical particle size measuring less than 20 μm . Fly ash particles less than 50 μm are generally spherical and the larger sizes tend to be more irregular. The relative density or specific gravity of fly ash generally varies from a low value of 1.9 to a high value of 2.8, which increases with the content of iron-oxides and decreases with unburned carbon. Fly ash pulverization also increases the bulk specific gravity of fly ash [29]. The specific surface area measured by Blaine air permeability method is typically 300 to 500 m^2/kg , although some fly ashes can have surface areas as low as 200 m^2/kg and as high as 700 m^2/kg . The particle density of fly ash varies from 2000-2400 kg/m^3 , which is considerably lower than for Portland cement at 3120 kg/m^3 . The colour of fly ash may vary from tan to gray to black, depending on the mineral constituents and amount of unburned carbon in the ash. The lighter colour indicates the lower amount of carbon contents whereas a dark gray to black color is typically attributed to elevated unburned carbon content [26-29].

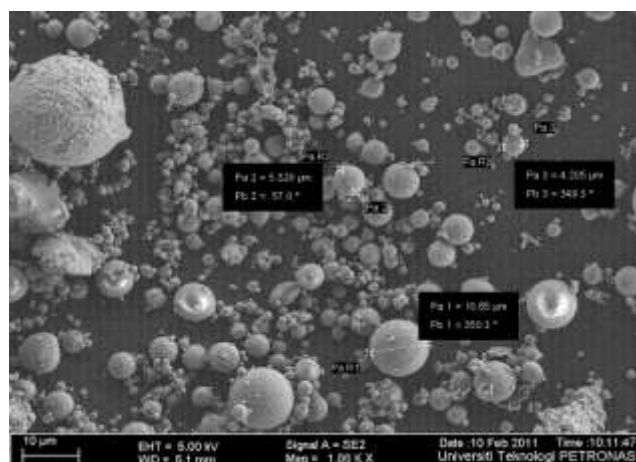

Figure 2.3 SEM Image of Fly ash [30]

(b) Chemical Composition

The type and relative amount of incombustible matter in the coal determines the chemical composition of fly ash [2]. The chemical composition of the fly ash varies significantly and shows a wide range of difference, indicating that there is a wide variation in the coal used in power plants all over the world. The principal components of coal fly ash are silica, alumina and oxides of iron and calcium, with varying amounts of carbon [27]. In addition, fly ashes also contain oxides of magnesium, sodium, potassium and sulphur. Sub-bituminous and lignite coal fly ashes are characterized by higher concentrations of calcium and magnesium oxide and lower percentages of silica and iron oxide, as well as lower carbon content, compared with bituminous coal fly ashes. Table 2.3 presents the normal range of chemical composition of fly ashes produced from different types of coal.

Table 2.3 Normal Range of Chemical Composition for Fly ash produced from different Coal types (expressed as percent by weight) [29]

Component	Bituminous	Sub-bituminous	Lignite
SiO ₂	20-60	40-60	15-45
Al ₂ O ₃	5-35	20-30	10-25
Fe ₂ O ₃	10-40	4-10	4-15
CaO	1-12	5-30	15-40
MgO	0-5	1-6	3-10
SO ₃	0-4	0-2	0-10
Na ₂ O	0-4	0-2	0-6
K ₂ O	0-3	0-4	0-4
LOI	0-15	0-3	0-5

- **Fly ash as a Source Material in Geopolymer Concrete**

Fly ash has been used in the past to partially replace the cement to produce concretes. However, in recent years, an important achievement in the use of fly ash is the development of geopolymer concrete, which enabled the replacement of cement up to 100% by mass. The presence of alumino-silicate phases in fly ash makes it a suitable raw material for the synthesis of geopolymer. In recent years, the use of fly ash as a source material in the development of geopolymeric materials has increased

dramatically because of its tendency to improve the properties of concrete and its positive impacts on environment. Many research studies [1, 13, 18, 19] have manifested the potential use of fly ash-based geopolymer concrete. These research studies have confirmed that geopolymer concrete derived from fly ash displayed good engineering properties. Geopolymer concrete produced from fly ash generally exhibit high and early compressive strength, low permeability, low creep and drying shrinkage, excellent resistance to sulphate attack, and good fire and acid resistance than Portland cement concrete [1, 5, 13, 31].

Fly ash is one of the important source materials for making geopolymers and both types of fly ash contain a reasonable amount of silica and alumina. In case of fly ash as a source material, low-calcium (ASTM Class F) fly ash is preferred than high calcium (ASTM Class C) fly ash as the presence of high amounts of calcium may interfere with the polymerization process and alter the microstructure [1, 32, 33]. According to Fernández-Jiménez & Palomo [32], in order to obtain the optimal binding properties of the geopolymeric material, fly ash as a source material should have low calcium content. Gourley [33] also confirmed that the presence of calcium in fly ash in significant quantities could interfere with the polymerization setting rate and alters the microstructure of the geopolymer. However, van Jaarsveld et al. [23] found that fly ash with higher amount of calcium produced higher geopolymer compressive strength, due to the formation of calcium aluminate hydrate and other calcium compounds, especially in the early ages. They reported that the calcium content in fly ash played a significant role in strength development and final compressive strength of the resulting geopolymer.

The strength of geopolymeric materials is believed to come from the strong chemical bondings in the alumino-silicate gel formed as well as the physical and chemical reactions occurring between the geopolymer gel and particulate aggregates [18]. The strength of fly ash-based geopolymer concrete predominantly depends on the fineness of fly ash, as finer the alumino-silicate sources; the easier dissolution and eventually gel formation proceed [34]. The geopolymers based on fly ash with the higher amount of fine particles and high content of glass phase will lead to higher degree of geopolymerization, resulting in higher compressive strength of geopolymer [35].

The reactivity of fly ash in alkali activated systems is positively influenced by a higher contents of vitreous phase and reactive silica and low contents of calcium and iron oxides [23, 32]. The alkali activation of low calcium Class F and high calcium Class C fly ashes was studied by Winnefeld et al. [36], to assess their potential for mortar and concrete production. The researchers reported that a high content of vitreous phase and low calcium content are the important factors for the reactivity and performance of fly ashes in alkali activated systems. Low calcium fly ash was much more reactive than the high calcium fly ash. In contrast to low calcium fly ash, in the high calcium fly ash, less alkali aluminate silicate hydrated and a much more porous microstructure was formed.

2.3.1.2 Silica Fume

Silica fume also known as microsilica or condensed silica fume, is an ultra fine non-crystalline mineral residue composed of amorphous glassy spheres of silicon dioxide (SiO_2) produced in electric arc furnaces as a by-product of the production of silicon metals and ferrosilicon alloys [37]. Silica fume, because of its physical properties and chemical characteristics, is a highly effective pozzolanic material [38]. Generally, silica fume is used in amounts between 5% and 15% by mass of the total cementitious material. It is used either as a cement replacement material to reduce the cement content or as an additive material to enhance the performance of concrete [39].

- **Characteristics of Silica fume**

The properties of silica fume mostly depend on the quality of the raw materials and the finishing processes. Silica fume consists of very fine vitreous particles with particle size generally varies from 0.1 to 0.5 μm , approximately 100 times smaller than Portland cement particles (Figure 2.4). The specific gravity of silica fume generally remains in the range of 2.2 to 2.5. However, due to high fineness, the bulk density of silica fume varies between 200 to 300 kg/m^3 as compared with about 1200 kg/m^3 for normal Portland cement. The specific surface area of silica fume measured

by nitrogen adsorption method ranges from 20000 to 25000 m²/kg while its color may vary from light to dark gray depending mainly on the content of carbon [38, 39].

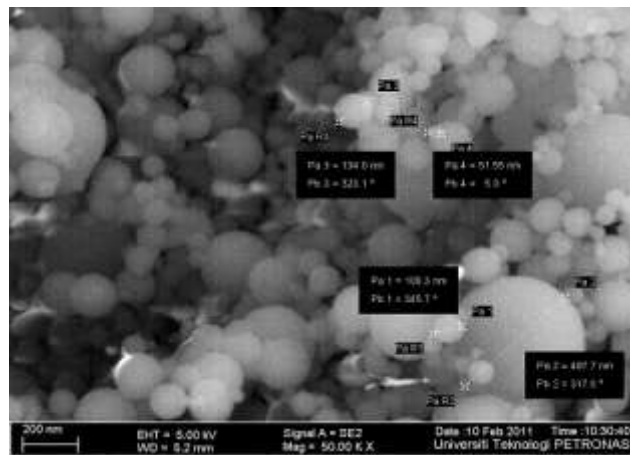

Figure 2.4 SEM Image of Silica fume [30]

Chemical Composition

The chemical composition of silica fume varies depending on the nature of the principal product being made by the furnace. The main constituent material in silica fume is silica (SiO₂) which is affected by the type of alloy being produced [40]. Usually, silica fume contains more than 90% of SiO₂ in amorphous form. It also contains smaller quantities of oxides of iron, aluminium, calcium, magnesium and other elements. Table 2.4 presents the chemical composition of typical silica fume.

Table 2.4 Chemical Composition of Silica fume [41]

Oxides	% by mass	Range (%)
SiO ₂	94.92	85-97
Al ₂ O ₃	0.02	-
Fe ₂ O ₃	1.28	-
CaO	0.03	< 1
MgO	0.01	-
K ₂ O	0.15	-
SO ₃	0.02	-
Na ₂ O	0.28	-
LOI	3.28	-

- **Silica fume as a Partial Replacement Material in Geopolymer Concrete**

The use of silica fume in cement concrete is known to cause significant changes in the structure of matrix by both a physical action and a pozzolanic reaction. Silica fume, because of its small particle size and spherical shape, fills the voids created by free water in the matrix. This particle packing effect refines the microstructure of concrete, creates a much denser pore structure, and results in an increase in the mechanical properties of concrete [38]. Although a considerable body of literature is available, which reports the use of silica fume as a partial replacement of cement in Portland cement concrete, however, relatively very little information is given considering its use in geopolymer concrete. Nevertheless, the published work has demonstrated that similar to Portland cement concrete, incorporation of small amounts of silica fume in geopolymeric concrete results in a significant improvement in the mechanical properties of geopolymeric concrete.

Khater [41] investigated the effect of silica fume addition on the properties of geopolymer materials produced from alkaline activation of metakaolin and demolished waste concrete. Sodium silicate solution and sodium hydroxide were used as alkali activators. Waste concrete was partially replaced by silica fume by 1 to 10%. Khater [41], reported that compressive strengths of geopolymer mixes incorporating silica fume increased up to 7% substitution and decreased up to 10% but still were higher than those of control mix. This was due to the fact that silica fume because of its higher surface area interacted with dissolved calcium from waste concrete material and formed CSH which positively affected the geopolymerization process by forming nucleation centers that consequently improved the compressive strength, bond strength and abrasion resistance. However, increasing the silica fume content beyond 7% caused negative effect by forming agglomerates which were concentrated in a small area and hindered the formation of both CSH and geopolymer phases resulting a decrease in the properties of geopolymer concrete.

Similarly, Chakraborti [42] studied the effect of silica fume additions on geopolymer, which was produced by activating low calcium fly ash with the combination of sodium hydroxide and sodium silicate. Ten series of mortar specimens were prepared by varying Si/Al ratio from 1.7 to 2.3 and % silica fume from 2.75% to

20%. The test specimens were cured in the oven at 85°C for 24 hrs. The compressive strength, splitting tensile strength, water absorption, water sorptivity and ultrasonic pulse velocity were observed at the age of 28 days. Chakraborti [42] reported that the properties of fly ash-based geopolymer were significantly affected by Si/Al ratio and content of silica fume in the mix. For a given Si/Al ratio, the addition of silica fume was found to be beneficial upto certain limit beyond that caused negative effect. Maximum compressive strength of 36.28 MPa was obtained for 11% silica fume with the Si/Al ratio of 2.3. However, increasing silica fume content beyond 11% inhibited the geopolymerization process resulting in decrease in the properties of geopolymer. This is because silica fume content up to 11%, resulted decrease in number and size of unreacted fly ash particles in the geopolymer matrix by forming additional aluminosilicate gels, which eventually resulted in increasing of compressive strength. However excess silica content hindered geopolymerisation process and structure formation contributing negatively to the properties of resulting geopolymer [42].

Dutta et al. [43] also found that silica fume addition upto 5% by mass enhanced the compressive strength of fly ash-based geopolymer mortars with the formation of a well-refined and compact matrix. However, further increase of silica fume caused a decrease in the compressive strength of geopolymer.

2.3.2 Alkaline Activators

In geopolymerization, high alkaline solutions are required to activate the silicon and aluminium present in the source material to dissolve and form geopolymeric paste. To control the geopolymerization process and to obtain the desired properties of the resulted geopolymer, the type of the alkaline solution has the significant importance [44]. The choice of the alkaline solution mainly depends upon the reactivity and the cost of the alkaline activators. The most frequent alkaline solution used in geopolymerization is a combination of sodium hydroxide or potassium hydroxide and sodium silicate or potassium silicate [1, 19]. Sodium based activators are more effective in promoting aluminosilicate dissolution than potassium based activators [45]. Previous studies indicate that sodium silicate solution in combination with sodium hydroxide is an effective alkaline solution. According to Hardjito et al. [46], for the synthesis of geopolymer concrete it is reasonable to use both sodium

hydroxide and sodium silicate as alkaline activators. The same has been reported by other researchers [19, 21].

Palomo et al. [19], in their study on fly ash-based geopolymers reported that the type of alkaline solution was the significant factor affecting the mechanical strength of geopolymers. They demonstrated that alkaline solution that contained soluble silicates was proved to increase the rate of reaction compared to alkaline solution that contained only hydroxide. They found that the combination of sodium silicate and sodium hydroxide produced the highest compressive strength.

Xu and Van Deventer [21] studied the alkali activation of different alumino-silicate minerals to make geopolymers. They used sodium or potassium hydroxide as an alkaline activator. They have reported that the addition of sodium silicate solution to the sodium hydroxide solution as an alkaline activator enhanced the reaction between the source material and the alkaline solution. They found that generally the sodium hydroxide solution caused a higher extent of dissolution of prime materials than the potassium hydroxide solution.

The ratio of sodium silicate to sodium hydroxide plays an important role in the compressive strength development of geopolymer concrete [47]. A higher amount of sodium silicate has a considerable positive effect on strength development, especially in the early stages after curing [48]. Sodium silicate to sodium hydroxide ratios of 1.5-2.5 have been shown to be appropriate [46]. According to Hardjito and Rangan [1], higher the ratio of sodium silicate to sodium hydroxide by mass, higher was the compressive strength of the fly ash-based geopolymer concrete. The authors have suggested that the ratio of sodium silicate solution to sodium hydroxide solution by mass may be approximately taken as 2.5. However, Chindaprasirt et al. [49] have reported that higher ratio of sodium silicate to sodium hydroxide was found to reduce the compressive strength of fly ash-based geopolymer. Chindaprasirt et al. [49] in their study on geopolymer mortar made from coarse lignite high-calcium fly ash revealed that the compressive strength of geopolymer mortars with sodium silicate to sodium hydroxide ratio of 0.67 and 1.00 were significantly higher than those with sodium silicate to sodium hydroxide ratio of 1.5 and 3.0. The authors demonstrated that to produce high strength geopolymer, the optimum sodium silicate to sodium hydroxide ratio was 0.67-1.0.

Concentration of sodium hydroxide is another important factor which plays significant role in geopolymer synthesis. The use of higher concentration of sodium hydroxide in the aqueous phase of the geopolymeric system leads to greater dissolution of the source materials and improves geopolymerization reaction [20]. According to Gasteiger et al. [50], the solubility of alumino-silicate increases with increase in hydroxide concentration as the more sodium hydroxide come in contact with the reactive solid material, the more silicate and aluminate monomers are released, which eventually results in higher compressive strength of geopolymer concrete.

Similarly, in a study performed by Hardjito et al. [51], to study the effects of concentration of sodium hydroxide solution on the compressive strength of fly ash-based geopolymer mortar, the authors reported that alkaline concentration was proportionate to the compressive strength of geopolymer mortar. Hardjito et al. [51] revealed that higher concentration of sodium hydroxide solution resulted in a higher compressive strength of geopolymer mortar.

Also, Wang et al. [52], in their study on the synthesis and mechanical properties of metakaolinite-based geopolymer reported that higher concentration of sodium hydroxide solution provided better dissolving ability to metakaolinite and produced more reactive bond for the monomer, consequently increased inter-molecular bonding strength of the geopolymer. They demonstrated that mechanical properties of the metakaolinite-based geopolymer activating metakaolinite with sodium hydroxide and sodium silicate solution were greatly dependent on the concentration of sodium hydroxide solution. With the increase of sodium hydroxide concentration, the compressive strength, flexural strength, and apparent density of the resulting geopolymer were increased.

2.4 Curing of Geopolymer Concrete

Geopolymer concrete is produced by activating alumino-silicate based source materials with alkaline solution via geopolymerization process. Activation of alumino-silicate based materials with alkalis generally requires heat curing for the

formation of alkali-activated binders [1]. Heat-curing substantially assists the chemical reaction that occurs in the geopolymer paste [6]. Curing of geopolymer concrete is mostly carried out at elevated temperatures [35], however, curing at ambient temperature has also been carried out. Metakaolin and slag based geopolymers can exhibit good mechanical properties, when cured at ambient temperatures [53], however, at ambient temperatures; the reaction of fly ash is very slow and usually show a slower setting and strength development [54]. Due to slow reactivity of fly ash at ambient temperature, considerable heat is required to increase the kinetics energy and degree of the reaction [48]. Higher temperatures tend to activate alumino-silicate phases in the fly ash, therefore, they are generally cured at temperatures between 60⁰C and 90⁰C [17, 19, 54].

Xu and van Deventer [21] revealed that the stable geopolymerization process requires higher temperature to accelerate the hydrothermal synthesis reaction. Curing at higher temperatures is effective and has more significant contribution to geopolymeric reactions as higher temperature increases the dissolution of precursors and accelerates the polymerization process resulting to an increase in compressive strength. The effect of temperature on the rate of reaction, however, becomes less significant once the material sets [55]. Hardjito et al. [1] also found that curing of geopolymer concrete at higher temperatures up to 60⁰C, yielded a higher compressive strength than at a lower temperature, yet any increase in curing temperature over this threshold made no significant difference to its strength.

Unlike to Portland cement concrete, geopolymer concretes set rapidly and attain about 70% of its total compressive strength value within the first 3-4 hrs of the curing [47]. Palomo et al. [19] reported that curing at high temperature is especially important for 2 to 5 hrs. They found mechanical strength of 60 MPa only after 5 hrs of curing at 85⁰C. Kirschner and Harmuth [56] also obtained the highest strength using alkali-activated metakaolin cured at 75⁰C during 4 hrs. Longer curing times improve the polymerization process and can increase the compressive strength of alkali-activated systems, but curing at elevated temperatures for extended periods of time has been reported to have a negative effect on the properties of geopolymer concrete as it decreases the compressive strength by breaking the granular structure of geopolymer matrix [47]. This may be due to the initial heavy formation of the

reaction product and a subsequent densification of material immediately upon alkaline introduction. The reaction product becomes exponentially less over time and increased temperatures only serve to degrade previously created alumino-silicate gels within the matrix, thus weakening the overall structure [57].

Rovnanik [58] in his study on effect of curing temperature on the development of metakaolin-based geopolymer has reported that curing temperature had significant effect on the setting and hardening of metakaolin-based geopolymer. According to Rovnanik [58], higher curing temperatures and longer curing time increased the early age compressive and flexural strengths. However, elevated temperature during the early stage of hardening process resulted to the formation of larger pores consequently increased the pore volume, which had a negative effect on the final mechanical properties of geopolymeric material. Other authors [17, 59] also noticed a strength decrease for long curing time with temperature.

Van Jaarsveld et al. [17] demonstrated that curing at elevated temperatures for longer periods of time may weaken the structure of geopolymer concrete, provoking a decrease in final strength values. Van Jaarsveld et al. [17] studied the interrelationship of certain parameters that affected the properties of fly ash-based geopolymer. They reported that the properties of geopolymer were influenced by the incomplete dissolution of the materials involved in geopolymerization. The authors have stated that the water content, curing time and curing temperature affected the properties of geopolymers; specifically the curing condition and calcining temperature influenced the compressive strength. They concluded that rapid curing and curing at high temperature reduced the compressive strength and caused a negative effect on the physical properties of the geopolymer.

In a study done by Guo et al. [59], on compressive strength and microstructural characteristics of Class C fly ash geopolymer, the authors have reported that curing temperature had a significant effect on the compressive strength development. Compressive strength began to decrease after curing for a certain period of time at higher temperature. They revealed that prolonged curing can break down the granular structure of the geopolymer mixture. In contrast, Daniel et al. [60] in their study on the behaviour of fly ash-based geopolymer mortars at elevated temperatures have

reported that longer curing time under elevated temperature did not significantly affect the compressive strength of geopolymer paste. Hardjito et al. [46] also shared the statement by disclosing that the strength development over time can be achieved with geopolymer concrete when curing time is extended. Hardjito et al. [46] reported that as the curing time increased in the range of 6 to 96 hrs, the polymerization process was improved and therefore yielded a higher compressive strength. However, increase in strength for specimens cured after 48 hrs was not significant.

2.5 Mechanical Properties of Geopolymer Concrete

Mechanical properties such as compressive strength, tensile and flexural strength, modulus of elasticity and creep and drying shrinkage are the key parameters for evaluating the performance of concrete and to predict the service life. The mechanical properties of geopolymer concrete have been reported to be equal to or better than those exhibited by equivalent Portland cement concrete. According to Sofi et al. [61], the properties of geopolymer concrete were similar to Portland cement-based concrete and depended upon the mix design and curing techniques. Some other authors [48] noticed the same behaviour. Olivia and Nikraz [48] in their study on the properties of fly ash-based geopolymer concrete revealed that the mechanical properties of the geopolymer mixtures were competitive with those of OPC-based concretes. These researchers reported that fly ash-based geopolymer concrete mixes exhibited higher tensile and flexural strengths and experienced less expansion, drying shrinkage, water absorption and sorptivity than those of OPC-based concrete. However, the modulus of elasticity of geopolymer concrete was found to be lower than that of OPC concrete. On the other hand, Rangan et al. [62] who performed significant research work on geopolymer concrete observed that the mechanical properties of their geopolymer concrete were better than those of conventional Portland cement concrete. The individual mechanical properties relevant to this study are detailed in the following sub-sections.

2.5.1 Compressive Strength

Among all the concrete properties, compressive strength is one of the most important properties of hardened concrete. Compressive strength has an intrinsic importance in characterizing material property. Several factors have been reported to affect the compressive strength of geopolymer concrete. These include the nature and type of source materials, the activator to source material ratio, the type and concentration of alkaline solution, the curing temperature and duration, and the age of the concrete [47, 52]. According to Xu and van Deventer [25], to produce geopolymers with a high compressive strength, source materials which possess high reactivity are required. The authors have further reported that significant improvement in the compressive strength can be achieved when a calcined source material such as fly ash is added to as compared to non-calcined source material for geopolymerization.

Van Jaarsveld et al. [23] in their research study reported that the particle size, calcium content, alkali metal content, amorphous content, morphology and origin of the fly ash affected the properties of geopolymers. It was also revealed that the calcium content in fly ash played a significant role in strength development and final compressive strength as higher calcium content resulted in faster strength development and higher compressive strength.

In a research conducted by Palomo et al. [19] to study the effects of the activator/fly ash ratio on the mechanical properties of fly ash-based geopolymer, the authors have concluded that effect of the activator solution/fly ash ratio was insignificant and was not a relevant parameter on the compressive strength of the geopolymer binder. However, according to Hardjito et al. [51], activator/fly ash ratio has a significant influence over the compressive strength of geopolymer mortar. Hardjito et al. [51] reported that with the increase of activator content, and consequently increasing the activator/fly ash ratio upto 0.40, the compressive strength of the resulting geopolymer mortar was increased. However, increasing the activator/fly ash ratio to 0.45, there was a decrease in the compressive strength of geopolymer mortar (Figure 2.5). This was possibly due to excess of OH⁻ concentration, which consequently decreased the strength of geopolymer mortar. Daniel et al. [60] in their research have also confirmed that the activator/fly ash ratio

was the most significant factor for compressive strength development. They found that when activator/fly ash ratio increased, the compressive strength was decreased.

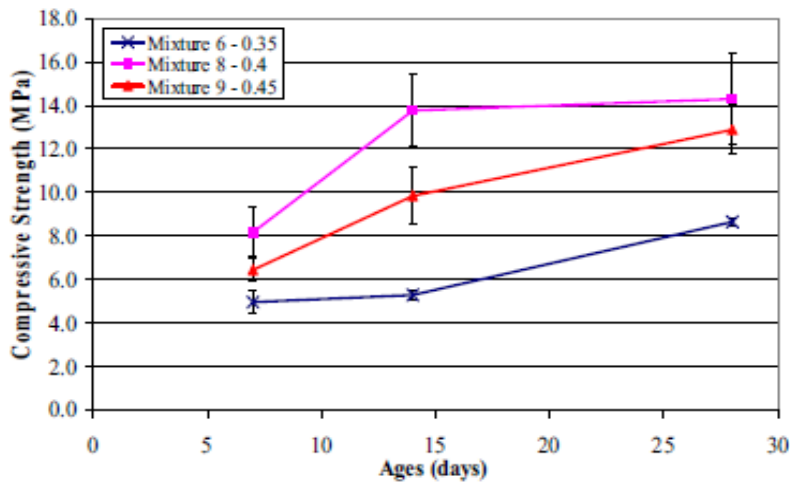

Figure 2.5 Effect of Activator/Fly ash Ratio on Compressive Strength [51]

Previous research has shown that the water/geopolymer solid ratio in the mixture composition also affects the compressive strength of fly ash-based geopolymer concrete. Compressive strength of geopolymer concrete significantly decreases as the water/geopolymer solid ratio increases (Figure 2.6) [51]. This trend is analogous to the well known effect of water/cement ratio on the compressive strength in OPC concrete, although the chemical reaction involved in the formation of both binders is entirely different.

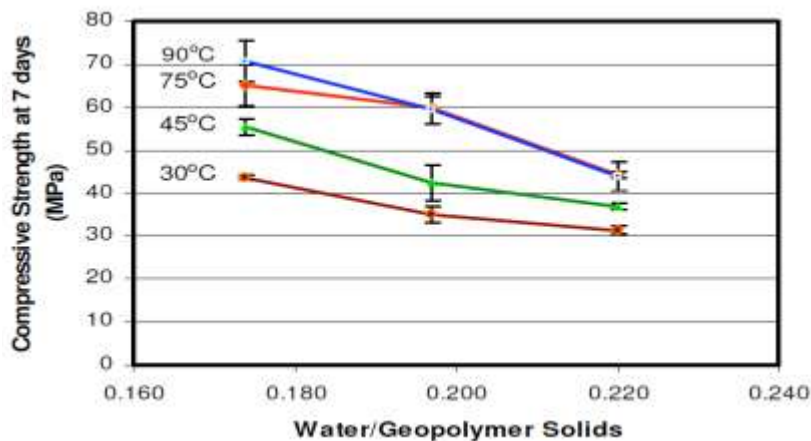

Figure 2.6 Effect of Water/Geopolymer solids Ratio on Compressive Strength [51]

Compressive strength of geopolymer concrete is significantly influenced by the curing temperature and duration. Longer curing time and curing at high temperature

increases the compressive strength of fly ash-based geopolymer concrete, although the increase in strength may be insignificant for curing at more than 60°C and for periods longer than 48 hrs (Figures 2.7 and 2.8) [63]. The statement is shared by Palomo et al. [19], who found that higher curing temperature and longer curing time proved to result in higher compressive strength of fly ash-based geopolymer. Van Jaarsveld et al. [17] however reported that curing at elevated temperatures for long periods of time may weaken the structure of hardened material resulting to a decrease in compressive strength.

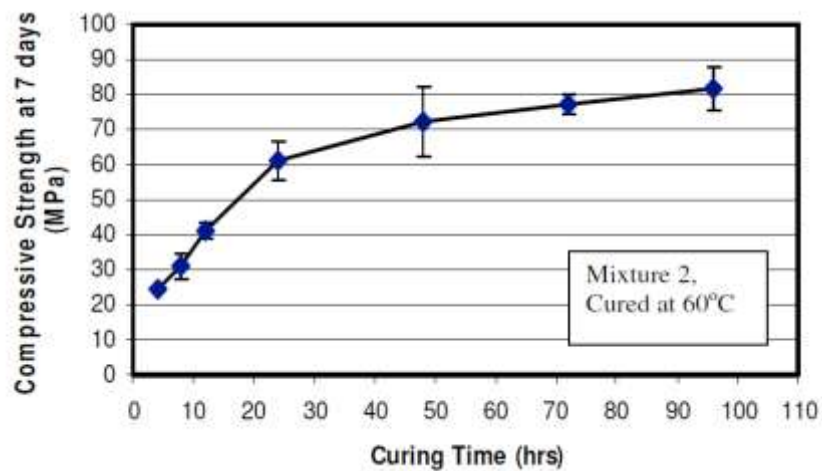

Figure 2.7 Effect of Curing Time on Compressive Strength [63]

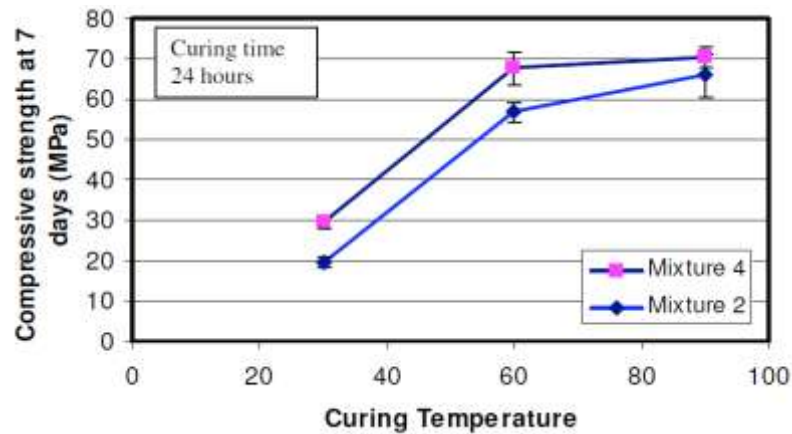

Figure 2.8 Effect of Curing Temperature on Compressive Strength [63]

Geopolymer concretes show fast hardening and high early compressive strength than traditional Portland cement concretes. Geopolymer products can attain structural integrity and reasonable strength in a relatively short time [34]. In many cases, 70% of the ultimate compressive strength is developed in the first four hrs of setting [6].

Because the chemical reaction of the geopolymer paste is a fast polymerization process, initial reactivity is intense and occurs quickly upon activation, but reaction products eventually coat remaining unreacted pozzolan particles and reduce the efficiency of activation. As the activator slowly permeates through the newly-formed coating, the reaction continues at a slower rate, and the compressive strength continues to gradually rise [64] but does not vary greatly with the age of concrete as shown in the Figure 2.9 [1]. This contrasts with the strength development behaviour of OPC-based concrete, where the hydration process extends over a length of time and gains strength with age [1].

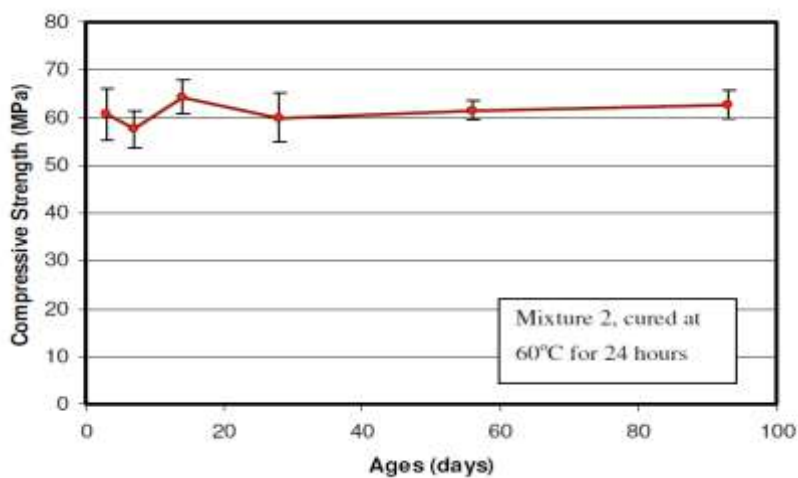

Figure 2.9 Compressive Strength Development of Geopolymer Concrete with Age [1]

2.5.2 Tensile and Flexural Strength

Although concrete mixes are proportioned on the basis of achieving the desired compressive strength at the specified age, however, the determination of tensile and flexural strength is helpful in mitigating the cracking problems, improving shear strength prediction and minimizing the failure of concrete in tension [65]. Geopolymer concretes are reported to have comparable or higher tensile and flexural strength values than the equivalent Portland cement concretes. As in the case of compressive strength, geopolymer concrete develops very high tensile and flexural strength at early ages, with gradual increase over time [47].

Hardjito and Rangan [1] measured the tensile strength of heat-cured fly ash-based geopolymer concrete by performing the cylinder splitting test on 150 x 300 mm concrete cylinders. The results of the test are illustrated in Table 2.5. Test results indicate that the splitting tensile strength of fly ash-based geopolymer concrete is a fraction of the compressive strength, as in the case of Portland cement concrete. Experimentally determined values of splitting tensile strength were also compared with the analytical models suggested by Standards Australia AS 3600-2001 and Neville for OPC-based concrete. Test results given in Table 2.5 clearly demonstrate that the measured values of splitting tensile strength of fly ash-based geopolymer concrete are significantly higher than the values recommended by the models considered in the study.

Table 2.5 Splitting Tensile Strength of Geopolymer Concrete [1]

Compressive Strength (MPa)	Indirect Tensile Strength (MPa)	Tensile Strength using AS 3600-2001 Model (MPa)	Tensile Strength using Neville Model (MPa)
89	7.43	3.77	5.98
68	5.52	3.30	5.00
55	5.45	3.00	4.34
44	4.43	2.65	3.74

Sofi et al [61] evaluated the engineering properties such as modulus of elasticity, Poisson's ratio, compressive strength, and the splitting tensile and flexural strength of six fly ash-based inorganic polymer concrete (IPC) mixes in compliance of the relevant Australian standards. Three different types of Class F fly ash were used in their study. The authors have reported that the engineering properties of inorganic polymer concrete complied with those for OPC-based concrete. The splitting tensile strength of the IPC mixes fallen within the range predicted for OPC-based concretes (Figure 2.10). Furthermore, the flexural strengths of fly ash-based inorganic polymer concretes were generally higher than the AS 3600 standard model line for OPC concrete, as shown in Figure 2.11.

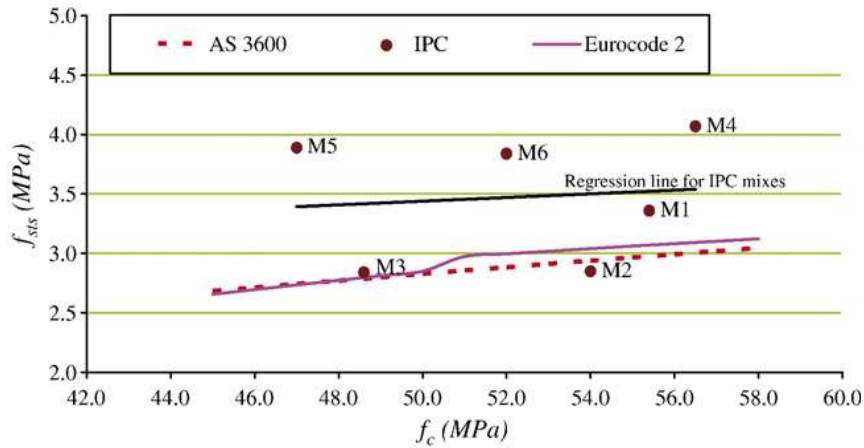

Figure 2.10 Splitting Tensile Strength of Fly ash-based IPC Mixes [61]

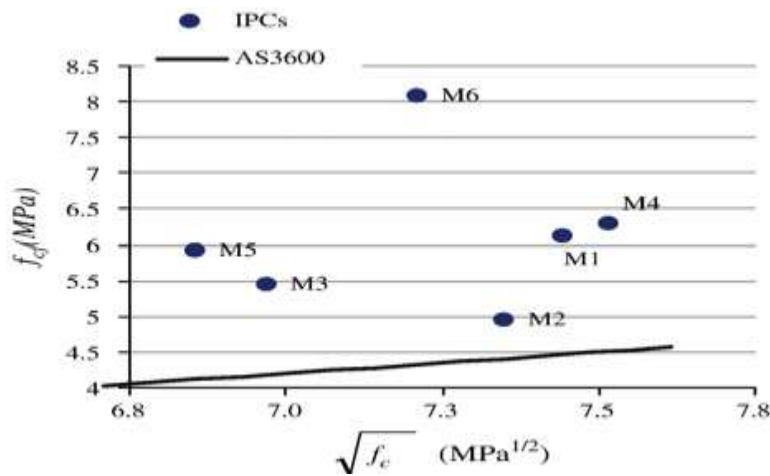

Figure 2.11 Flexural Strength of Fly ash-based IPC Mixes [61]

Olivia and Nikraz [48] performed a study on mechanical properties and durability of fly ash-based geopolymer concrete. A total of nine mixtures were assessed by considering the effects of aggregate content, alkaline solution to fly ash ratio, sodium silicate to sodium hydroxide ratio and curing method. Taguchi method was used to optimize the geopolymer mixes. The authors have reported that both splitting tensile and flexural strength of the geopolymer concrete increased with increasing concrete age. The splitting tensile strength values of fly ash-based geopolymer concrete were comparable or higher than those of OPC-based control concrete. The tensile strength of optimal mix T10 was 8-12% higher than that of OPC concrete at 28 and 91 days. This could be due to the effective bonding between the geopolymer matrix and aggregate. The flexural strength of the geopolymer concrete was found to be 1-1.4 times higher than that of the OPC concrete at 28 and 91 days. Figures 2.12 and 2.13 illustrate the test results.

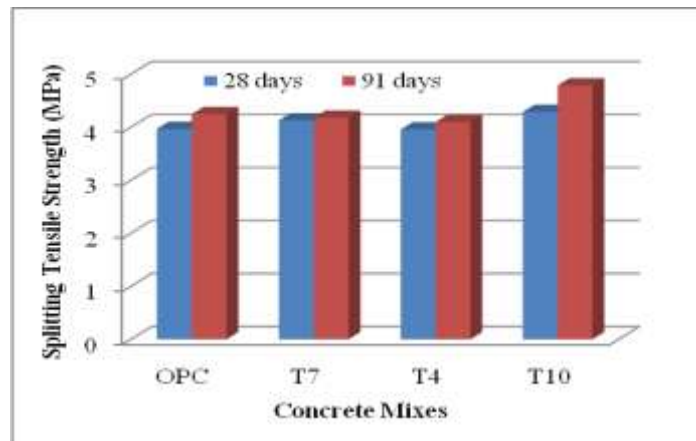

Figure 2.12 Splitting Tensile Strengths of OPC and Geopolymer Concrete Mixes [48]

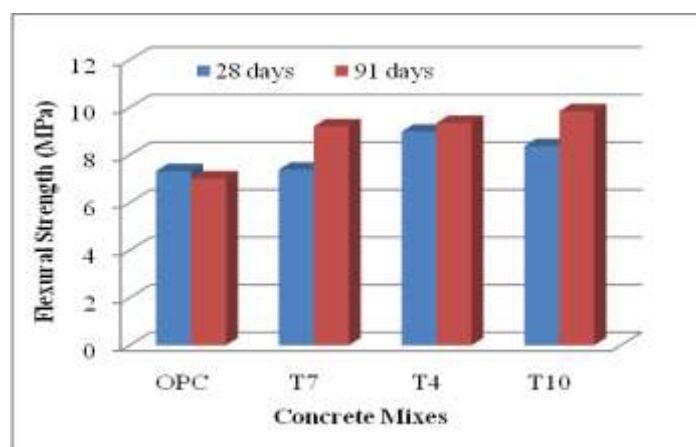

Figure 2.13 Flexural Strength of OPC and Geopolymer Concrete Mixes [48]

Yang et al. [66] designed and tested twelve alkali-activated cementless mortars and a control OPC mortar to assess the engineering properties including compressive strength, modulus of rupture and shrinkage strain. Fly ash and GGBS were used as source materials while sodium silicate powder was used as alkali activator. The authors have reported that flexural strengths (modulus of rupture) of alkali-activated mortars were comparable or higher to those of OPC mortar (Figure 2.14). The rupture modulus of alkali activated mortars increased with the increase of alkali quality coefficient. However, the normalized rupture modulus of alkali activated mortars was nearly independent on the alkali quality coefficient. The $f_r / \sqrt{f'_c}$ value of GGBS-based alkali activated mortar having an average value of 1.3 was much higher than that of both fly ash-based alkali activated and OPC mortars. However, the $f_r / \sqrt{f'_c}$ value of alkali activated fly ash-based mortar was similar to that of OPC mortar.

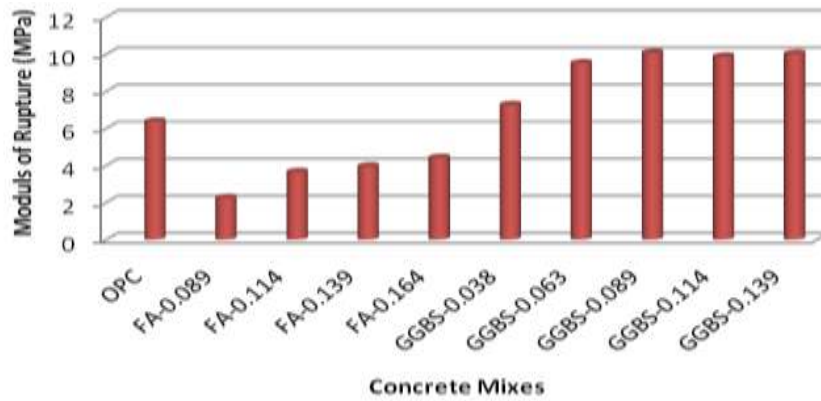

Figure 2.14 Flexural Strength of Alkali-activated Mortars [66]

2.5.3 Modulus of Elasticity

Modulus of elasticity is one of the important mechanical properties of concrete used for designing and analyzing the strength and serviceability of concrete structures. In particular, knowledge of this parameter is necessary when the deformations of the different structural elements of a structure have to be calculated [67]. Several researchers have studied the elastic characteristics of geopolymer concrete. Most of the research studies have reported that elastic modulus of geopolymer concrete was lower than that of OPC concrete. Puertas et al. [68] reported that alkali activated mortars prepared with 8 M sodium hydroxide exhibited 14-22% lower moduli of elasticity than OPC-based mortars. Fernandez-Jimenez et al. [69] also found that the addition of soluble silicates in the alkaline solution although improved the modulus of elasticity in fly ash-based geopolymer concrete. However, this improvement was not sufficient and the alkali activated fly ash-based concrete showed a much lower static modulus of elasticity than expected. Hardjito and Rangan [1] however observed better elastic modulus results for fly ash-based geopolymer concrete samples.

Hardjito and Rangan [1] studied the stress and strain behaviour of fly ash-based geopolymer concrete and compared it with that of conventional Portland cement concrete. The authors have reported that the modulus of elasticity and Poisson's ratio of fly ash-based geopolymer concrete were of same characteristics possessed by OPC concrete. Also, the measured stress-strain relationship of geopolymer concrete fit well with equations designed for Portland cement concrete. The measured values of the modulus elasticity of geopolymer concrete with compressive strength in the range of

44 to 89 MPa were similar to those of OPC concrete, yet the measured values were at the lower end of the values calculated using the current design Standards as shown in Table 2.6. This could be due to the type of coarse aggregate used in the manufacture of the geopolymer concrete. However, the Poisson's ratio of fly ash-based geopolymer concrete with compressive strength in the range of 44 to 89 MPa fallen between 0.12 and 0.16 which were quite similar to those of OPC-based concrete.

Table 2.6 MOE and Poisson's Ratio of Geopolymer Concrete at 90 Days [1]

Compressive Strength (MPa)	Measured MOE (GPa)	MOE using AS 3600 model (GPa)	MOE using ACI 363 model (GPa)	Poisson's Ratio
89	30.8	39.5 ± 7.9	38.2	0.16
68	27.3	36.2 ± 7.2	34.3	0.12
55	26.1	33.9 ± 6.8	31.5	0.14
44	23.0	31.8 ± 6.4	28.9	0.13

To evaluate the elastic characteristics of six IPC mixes, Sofi et al. [61] performed tests on cylindrical specimens measuring 150×300 mm. Tests for the determination of the static modulus of elasticity and Poisson's ratio of the specimens were carried out in accordance with relevant Australian Standards. Experimentally determined values of the elastic moduli of IPC mixes were then compared with the models designed for OPC-based high strength concretes. The results of the test are shown in Figures 2.15 and 2.16. The authors have reported that except for the Mix 4, most of the results obtained for the IPC mixes were below the lower limit allowed by AS 3600 model. In addition, the value of Poisson's ratio for all of the IPC mixes fallen between 0.23 and 0.26, which were slightly higher than the values assigned for OPC-based concrete.

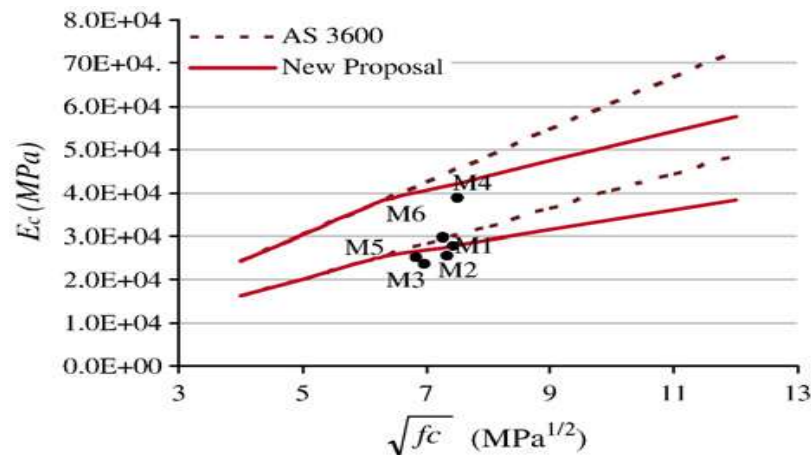

Figure 2.15 Modulus of Elasticity of IPC Mixes [61]

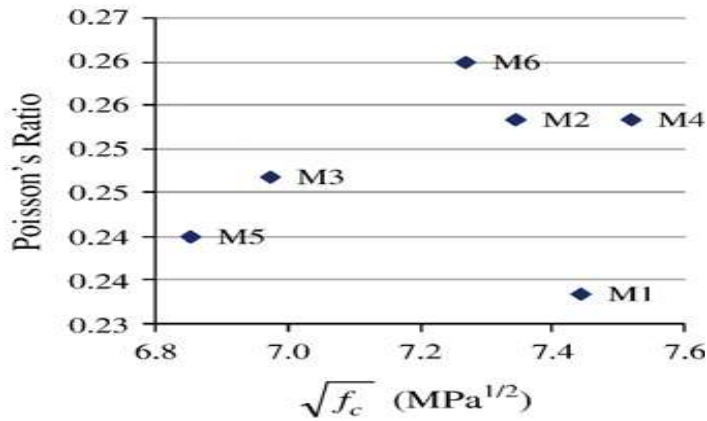

Figure 2.16 Poisson's Ratio of IPC Mixes [61]

Olivia and Nikraz [48] also found that the modulus of elasticity of fly ash-based geopolymer concrete was 14.9-28.8% lower than that of the OPC concrete suggesting that high silicate content might increase the elasticity of geopolymer concrete. The two authors have argued that the low elastic modulus can decrease the rate of crack propagation caused by corrosion of steel reinforcements, as is the case for high tensile and compressive strength. The values of Poisson's ratio for all geopolymer concrete mixes however were found to be comparable with those of OPC concrete (Table 2.7).

Table 2.7 MOE and Poisson's Ratio of OPC and Fly ash-based GC Mixes [48]

Mixture ID	Compressive Strength (MPa)		Modulus of Elasticity (GPa)		Poisson's ratio	
	28 days	91 days	28 days	91 days	28 days	91 days
OPC	56.22	65.15	34.16	37.64	0.14	0.15
T7	56.49	56.51	25.33	27.18	0.15	0.17
T4	56.24	58.85	26.95	28.03	0.13	0.15
T10	60.20	63.29	29.05	26.80	0.15	0.15

Bondar et al. [70] however revealed that natural pozzolan-based geopolymer concrete showed moderate to high modulus of elasticity values than equivalent OPC-based concrete. In their experimental study on the engineering properties of geopolymer concrete prepared with activated Iranian natural pozzolan, authors measured modulus of elasticity by testing 100 x 200 mm cylindrical specimens. The specimens were tested at 7, 14, 28, 90 and 180 days. Bondar et al. [70] have reported that during the first 14 days, geopolymer concrete mixes generally had lower values of static modulus of elasticity than OPC concrete mixes. However, with increasing

age, the modulus of elasticity of geopolymer concrete mixes was also increased. At 180 days, in comparison to 29 GPa, exhibited by OPC concrete mixes, the alkali activated natural pozzolan concrete mixes experienced 26.8 to 32.7 GPa, which were around 5 to 20% higher than those of OPC-based concrete mixes. Figure 2.17 illustrates the test results.

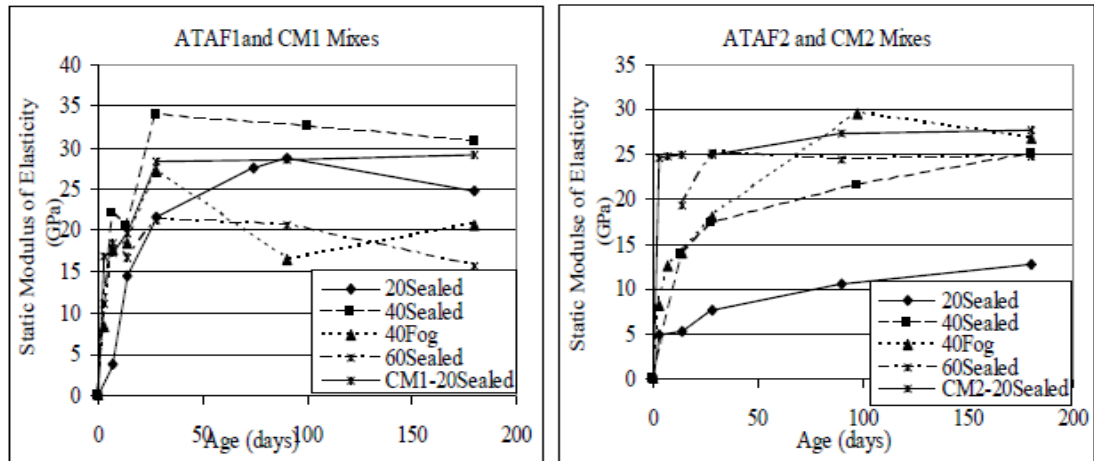

Figure 2.17 MOE of Alkali-activated Natural Pozzolan Concrete Mixes [70]

2.5.4 Creep

Creep and drying shrinkage are the two critical properties of hardened concrete and the prediction of time-dependent creep and drying shrinkage deformations is an important aspect in evaluation of the long-term behaviour of concrete [71]. Although several studies have been reported on the creep and shrinkage behaviour of OPC-based concrete, however, relatively little information is available concerning the creep and drying shrinkage of geopolymer concrete. Data available indicate that hardened geopolymer concrete tended to have a lower creep than Portland cement concrete [13]. The exact reason for this behaviour though remains unclear, however, it is believed that the lower creep strains of fly ash-based geopolymer concrete might be due in-part to unreacted or partially reacted fly ash particle residues acting as ‘micro-aggregates’ in the matrix [13]. Hence, the additional restraining action due to micro-aggregates could potentially contribute to smaller creep compared to OPC concrete. Given that the aggregate fraction remains primarily responsible for counteracting creep and drying shrinkage deformations of the binder phases [71].

Wallah and Rangan [13] performed laboratory tests on low-calcium fly ash-based geopolymer concrete to evaluate the creep behaviour of geopolymer concrete. Four series of specimens with compressive strengths in the range of 40-67MPa were prepared. The creep tests were performed in accordance with the relevant Australian Standards and the creep behaviour of fly ash-based geopolymer concrete was studied for a period of one year. The creep tests commenced on the 7th day after casting the test specimens and the creep specimens were subjected to a load of 40% of the compressive strength on that day. The test results are shown in Figures 2.18-2.20. Wallah and Rangan [13] revealed that the fly ash-based geopolymer concrete experienced lesser creep compared to Portland cement concrete. Similar to OPC concrete, specific creep of fly ash-based geopolymer concrete decreased as the compressive strength increased. After one year of loading, the specific creep of fly ash-based geopolymer concrete ranged from 15 to 29 microstrain for the corresponding compressive strength of 67 to 40 MPa, while the creep coefficient was between 0.6 and 0.7 for compressive strengths of 40, 47, and 57 MPa and for compressive strength of 67 MPa, this value was between 0.4 and 0.5. These values were about 50% of the values recommended by the Australian Standard AS 3600 for Portland cement concrete. The two authors believe that this could be due to the formation of micro-aggregates in the system which increased the creep resisting function of the fly ash-based geopolymer concrete resulting in smaller creep compared to OPC concrete.

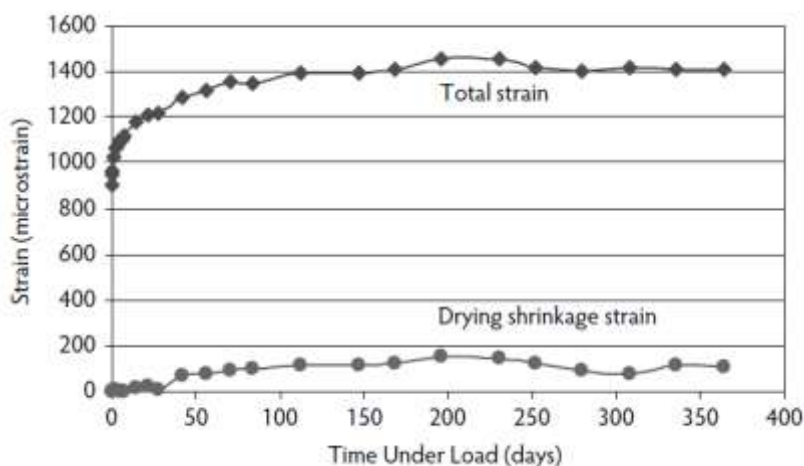

Figure 2.18 Total Strain and Drying Shrinkage Strain of Geopolymer Concrete [13]

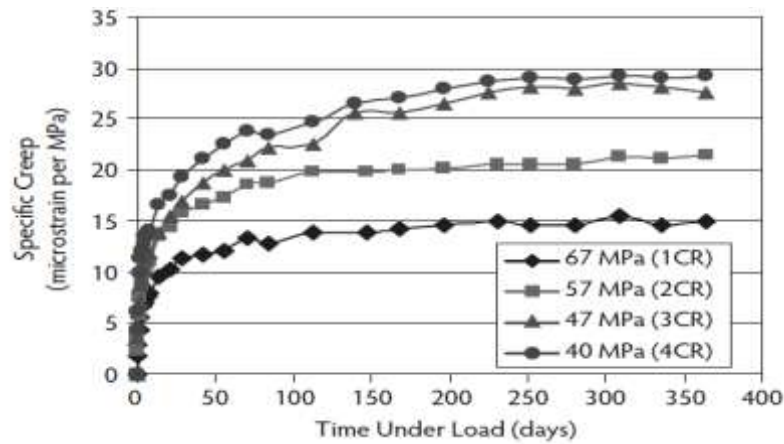

Figure 2.19 Specific Creep of Fly ash-based Geopolymer Concrete [13]

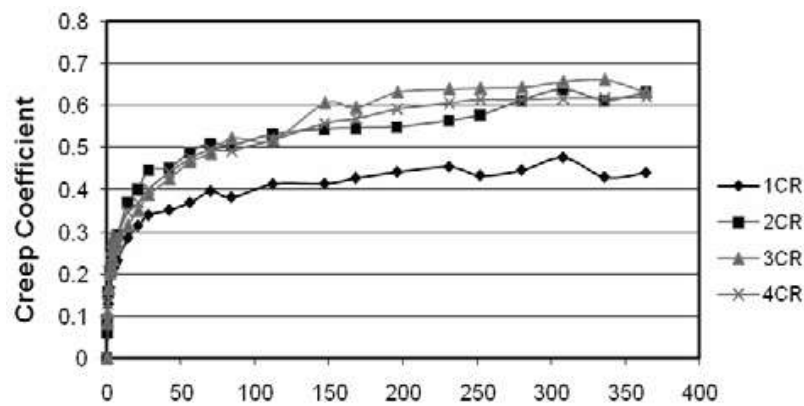

Figure 2.20 Creep Coefficient of Fly ash-based Geopolymer Concrete [13]

Sagoe-Crentsil et al. [71] also investigated the creep and drying shrinkage behaviour of fly ash-based geopolymer concrete using equivalent grade 40 MPa OPC-based concrete as the reference concrete. The creep specimens were loaded to 40% of the 28-days compressive strength and creep strains were recorded up to 52 weeks. Figure 2.21 illustrates the test results. Sagoe-Crentsil et al. [71] have reported that the creep strains of fly ash-based geopolymer concrete were generally smaller than that of Portland cement concrete. The creep coefficient of geopolymer concrete, measured as the ratio of the creep strain to elastic strain, after one year of loading was of the order of 0.10. This value was about 40–60% lower than the corresponding OPC concrete. The restraining effects of unreacted fly ash residue particles acting as micro aggregates in geopolymer concretes appeared to be major contributors to observed differences in creep performance of the two types of concrete.

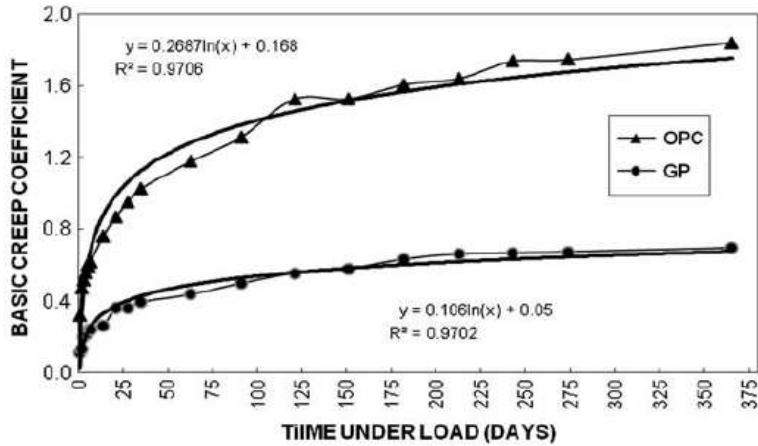

Figure 2.21 Creep Coefficient of Steam-cured OPC and Geopolymer Concrete [71]

2.5.5 Drying Shrinkage

Concretes whether produced with Portland cement or geopolymer binder share the similar feature in that they are porous materials and can be expected to suffer an induced isotropic compressive stress within the rigid binder phase when the excess water begins to evaporate. This hydrostatic tension, commonly termed as shrinkage, causes capillary pressures leading to cracking in concrete [72]. It has been reported that the drying shrinkage of heat-cured geopolymer concrete is generally very low compared to that of OPC-based concrete. As displayed by Wallah and Rangan [13], in fly ash-based geopolymer concrete, most of the water released during the chemical reaction may evaporate during the curing process. As the remaining water contained in the micro-pores of the hardened concrete is small, the induced drying shrinkage is very low [13]. The statement is shared by Palomo et al. [73] who have reported that the engineering performance of geopolymer concrete synthesized from fly ash was excellent, and the drying shrinkage was significantly low. Other researchers [48] also noticed the same behaviour. However, Wang et al. [74] mentioned that due to the formation of silica-rich gel, GGBS-based concrete activated by water glass may experience higher shrinkage strains than in OPC-based concrete. A brief description of few studies is given below.

To evaluate the long-term performance and durability of geopolymer concrete, Wallah and Rangan [13] performed tests on low-calcium fly ash-based geopolymer

concrete. The creep and drying shrinkage behavior of geopolymer concrete was studied for a period of one year. Test results indicated that heat-cured fly ash-based geopolymer concrete experienced significantly low drying shrinkage in the order of about 100 micro strains after one year as shown in Figures 2.22 and 2.23. This value was significantly lower than the range of values of 500 to 800 microstrains experienced by the Portland cement concrete. The drying shrinkage strains of geopolymer concrete specimens cured in ambient conditions were however larger than those experienced by the heat-cured specimens. This might be due to the fact that water released during the geopolymerization evaporated over a longer period of time relative to those cured under heated conditions causing significantly large drying shrinkage strains [13].

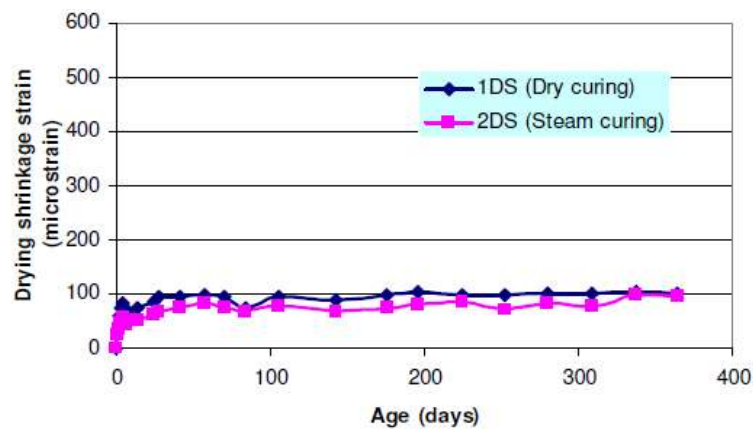

Figure 2.22 Drying Shrinkage of Heat-cured Fly ash-based Geopolymer Concrete [13]

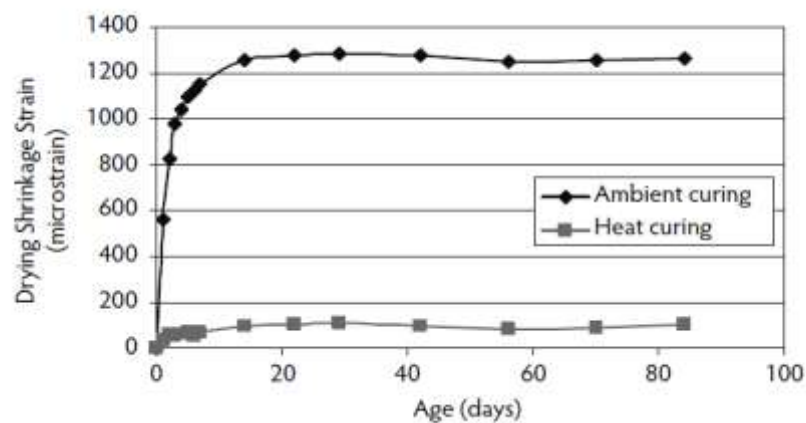

Figure 2.23 Drying Shrinkage of Heat-cured and Ambient-cured GC [13]

In an experimental study on time-dependent deformations of geopolymer concrete, Sagoe-Crentsil et al. [71] performed tests on 75x75x300 mm prisms in accordance

with relevant Australian standards. Drying shrinkage strains were recorded for a period of one year. The authors have reported that the drying shrinkage strains of fly ash-based geopolymer concrete were lower than those of equivalent OPC concrete. The values fell well below the nominal 700 microstrain limit specified in Australian standard, with geopolymer concrete values typically less than 400 microstrain at one year (Figure 2.24). At early ages (i.e. <7 days), both OPC and geopolymer concretes exhibited rapid increase in drying shrinkage and behaviour of the two concretes was very much similar. The average change in shrinkage values between 7 and 56 days of the geopolymer samples was of the order of 250 microstrain. This value was much lower compared to the value of 400–450 micrstrain experienced by OPC concrete. This might be due to the increased condensation reactions occurring in heat-cured geopolymer concrete. As, when the condensation reactions of geopolymer concrete are accelerated by heat curing, the associated initial drying shrinkage is significantly reduced, signifying the completion of initial condensation reactions and moisture loss from capillaries.

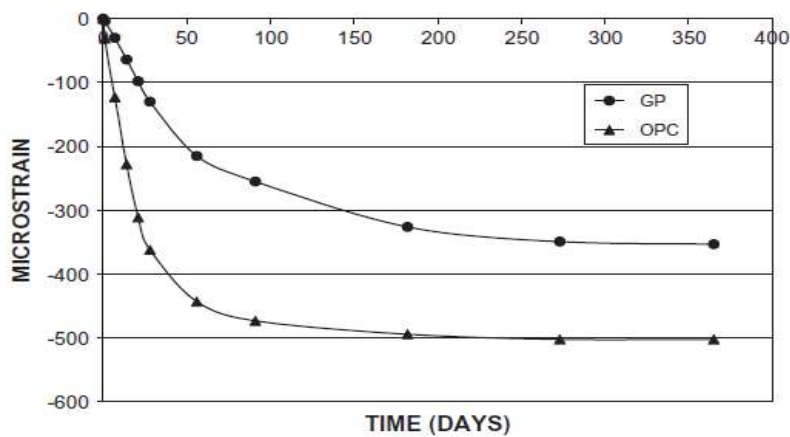

Figure 2.24 Drying Shrinkage for 40-MPa GP and OPC Concretes [71]

Olivia and Nikraz [48] in their study on the mechanical properties and durability of concrete produced from the optimal mixes have reported that the fly ash-based geopolymer concrete exhibited less expansion and drying shrinkage than OPC concrete. The authors have demonstrated that the drying shrinkage of the OPC-based concrete over the 11 weeks after curing was more than 400 microstrain, and then decreased to around 300 microstrain as shown in Figure 2.25. On the other hand, in general, the drying shrinkage of geopolymer concrete mixes were less than those of

the OPC concrete although some mixes showed minor expansion throughout 91 days after curing. There was no water loss from the geopolymer concretes either during geopolymerization or after steam curing. This might be due to the low water content of the geopolymer mixtures.

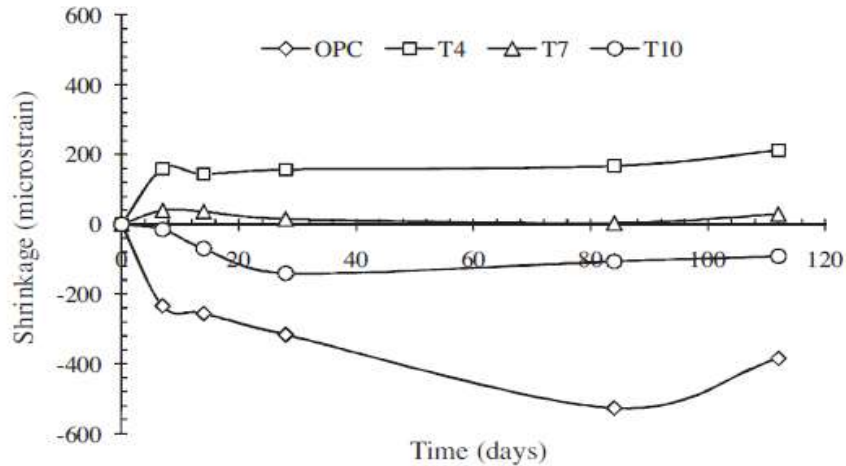

Figure 2.25 Drying Shrinkage of OPC and Three Optimal Geopolymer Concretes [48]

2.6 Self-Compacting Concrete

Increasing the productivity and improving the working environment have the high priority in the development of concrete construction over the last two decades. Current scenario in the construction industry shows increased construction of large and complicated structures. There is a general move towards slimmer elements, which often leads to difficulty in vibration of the concrete because of congested reinforcement. In situations, when large quantity of heavy reinforcement is placed in reinforced concrete members, it becomes difficult to ensure proper filling of the formwork and full compaction of the concrete without voids or honeycombing. Compaction is a method of giving a closer arrangement of the solid particles in early age concrete by reduction of inter-particle voids. Insufficient compaction results in entrapped air and other defects, which not only leads to a reduction in compressive strength but also strongly influences the protection of embedded steel reinforcement afforded by concrete [75]. Adequate compaction ensures maximum density that is achieved by fully evicting entrapped air entrained during mixing and placing. This results in satisfactory strength, good bond with the steel reinforcement and

impermeable protective cover to the steel reinforcement. Conventional concrete is normally compacted manually using vibrators, often operated by unskilled workers. The consequences of concrete compaction not only affect the material but also have health and safety and environmental risks, and high levels of noise. SCC alleviates the problems associated with conventionally placed concrete.

SCC is a type of concrete that spreads inside the formwork and pass around the reinforcement and through the narrow sections under its own weight without showing segregation or bleeding and consolidate without any mechanical vibration [76]. The hardened concrete is thus dense, homogeneous and possesses the same engineering properties and durability as conventional vibrated concrete [11].

The constituent materials used for the production of SCC are the same as those for conventional concrete except that SCC consist different proportions and additional chemical and mineral mixtures. SCC is able to accomplish high flowability due to its lower coarse aggregate content, higher cementitious materials content, lower water-powder ratio and the use of superplasticizer and viscosity modifying agents [77].

SCC offers several advantages over conventional vibrated concrete [10, 11]. These may include:

1. Greater freedom in design
2. Slimmer concrete section
3. Easier placement in congested reinforcements
4. Reduced site man power for placing and compacting
5. Reduced noise levels during casting on and around site due to absence of vibration
6. Improved health and safety due to elimination of handling of vibrators
7. Reduced construction time and improved productivity
8. Uniform and complete consolidation
9. Increased bond strength
10. Improved quality of concrete and reduction of onsite repairs
11. Improved durability and reliability of concrete structures
12. Reduced labour and equipment cost and
13. Lower overall costs

Despite all the positive attributes, one of the drawbacks of SCC is its increased cost, associated with the use of high volumes of Portland cement and use of chemical admixtures. However, the use of supplementary cementitious materials such as fly ash, GGBS, and/or limestone can offset the higher material costs. Besides, the significant cost savings can be realised in other areas such as speed of placement, decreasing the construction time and labour cost, which in some cases may result in even more reduced prices of the final product.

2.7 Development of SCC

In the early 1980s, the problem of durability of concrete structures became a major issue in Japan, where the lack of uniform and complete consolidation was identified as the primary factor responsible for poor performance of concrete structures [7, 10]. To make durable concrete structures, sufficient compaction by skilled workers is required. However, the gradual reduction in the number of skilled workers in Japan's construction industry led to a similar reduction in the quality of construction work [10]. Recognizing the lack of uniformity and complete compaction of concrete by vibration, the construction industry together with academia, started to find new solutions for difficulties encountered with the durability of concrete structures. The breakthrough occurred when the researchers at the University of Tokyo, Japan, developed a type of concrete that would deform under its own weight, without the need for external vibration [8, 77].

It is generally accepted that SCC was first developed in Japan in the late 1980s as a means to cater uniformity in the quality of concrete by controlling the ever present problem of insufficient compaction by untrained workforce and by the increased complexity of modern structural members. According to Ouchi [78], the concept of SCC was first proposed by Okamura in 1986 and the first prototype was developed in 1988 by Ozawa. Collepardi [79] however negates that self-levelling concretes were studied as early as 1975 and used in commercial applications in Europe, the United States, and Asia in the 1980s. In either case, despite its very early introduction and good hard evidence, its adoption was slow. The concept did not get the expected widespread recognition in everyday concrete construction. However, the use of SCC

gradually increased and gained momentum in the late 1990s. In 1996, several European countries formed the “Rational Production and Improved Working Environment through using SCC” project in order to explore the significance of published achievements in SCC and develop applications to take advantage of the potentials of SCC. Since then, SCC has been used successfully in a number of applications including bridges, walls and tunnel linings in Europe and other parts of the world [80-82].

2.8 Composition of SCC

SCC is a sensitive mix, strongly dependent on the composition and the characteristics of its constituents. It has to possess the incompatible properties of high flowability together with high segregation resistance. With regard to its composition, SCC consists of the same ingredients as conventionally placed normal concrete such as cement, aggregates, water, additives and admixtures. However, to attain high flowability and high segregation resistance, in comparison to conventionally placed concrete, SCC normally contains higher powder content, higher paste volume, lower water/powder ratio and lower coarse aggregate [11]. A comparison of mix proportioning between SCC and conventional concrete is shown in Figure 2.26.

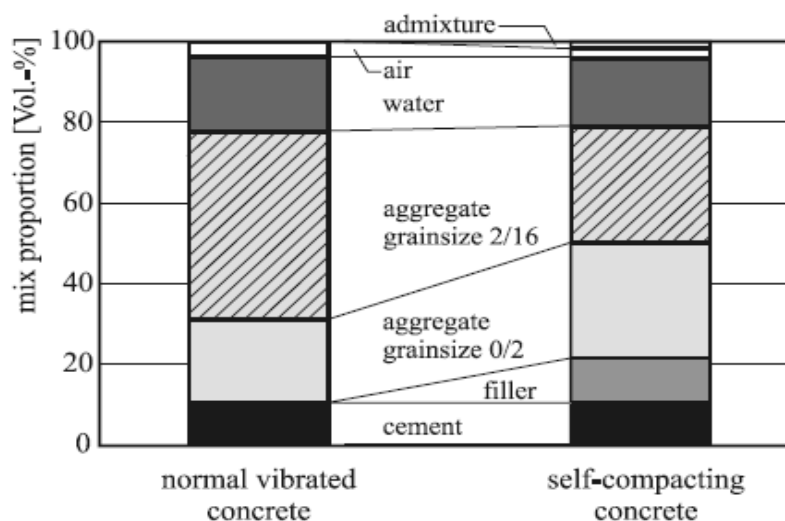

Figure 2.26 Mix Composition of SCC in Comparison with NVC [83]

SCC can be proportioned in several ways; however, a suitable mix is generally developed among the three different types. These include: Powder-type, viscosity modifying admixture (VMA) type and Combined- type.

Powder-type SCC is characterized by a high powder content and a low water/powder ratio, which are used to limit the free water content and increase the plastic viscosity. Free water is the water which is not adhered to the solid particles and move independently from the solids in a mixture. According to Khayat and Somnuk [84], it is essential to reduce the amount of free water in the mixture as excessive free water will decrease the viscosity of the SCC mixture. The amount of free water can be reduced by utilizing powder materials with a high surface area or low/water binder ratios or both. Since, at constant water content, powder materials absorb greater amount of free water than cement particles. Thus, the plastic viscosity of the mix is increased. Also, the lower water/binder ratio will increase the phase-to phase cohesion leading to an increase the segregation resistance [85]. Because of the high powder content, Powder-type mixes are sensitive to changes in constituent materials. Due to the low water/powder ratio, such types of mixes are expected to have a high strength and shrinkage, and low permeability.

VMA-type utilizes lower powder content, higher water/powder ratio and a viscosity modifying admixture. VMAs can provide adequate stability, reduce bleeding, and segregation resistance over a wider range of fluidity. The addition of a VMA may increase the viscosity of a mix to the extent that the water/powder ratio need not be increased [86]. Compared with powder-type SCC, VMA-type is higher in superplasticiser dosage or water/powder ratio to obtain the required filling ability. Powder content is less because viscosity is controlled by the addition of VMA.

Combined-type is developed to improve the robustness of powder-type SCC by adding a small amount of VMA. In such mixes, the VMA contents are less than those in the VMA-type SCC; the powder content and water/powder ratio are less than those in the powder-type SCC. This type of SCC was reported to have high filling ability, high segregation resistance and improved robustness [87].

2.9 Fresh Properties of SCC

SCC is a type of concrete that in its fresh state homogeneously fills out the formwork thoroughly and encloses the reinforcement while maintaining the resistance to segregation without any external vibration. SCC is defined primarily in terms of its fresh properties and is designed to have fresh properties that exhibit superior workability than normally vibrated concrete. Workability illustrates the performance of concrete in the fresh state and for SCC; workability is often characterized by the three key properties, which are fundamental to its performance both in fresh and hardened state. According to EFNARC [11], a concrete mix can only be classified as SCC if the requirements for all the following three workability properties are fulfilled. The three essential fresh properties required by SCC are:

a) Filling ability - It is the ability of concrete to flow under its own weight and fill completely all spaces within the intricate formwork without leaving voids. Filling ability indicates the deformability of SCC. Deformability includes two aspects: the deformation capacity (the maximum distance that the concrete can flow) and the deformation velocity (the time taken for the concrete to spread). Filling ability is a balance between deformation capacity and deformation velocity. For example, if concrete has high deformation capacity and very low deformation velocity, it tends to be very viscous and may take long time to fill the entire spaces of the formwork [88]. Filling ability is the primary characteristic that defines SCC. For a mixture to be considered SCC, it must have adequate filling ability. To achieve adequate deformability/filling ability in concrete, the inter-particle friction among the solid particles must be reduced by increasing the paste volume and utilizing a high range water reducing admixture (superplasticizer) and a lower coarse aggregate content [89, 90]. The addition of excess water may also improve filling ability by lowering the inter-particle friction; however, it will reduce viscosity, leading to segregation [11, 81]. Too much water also results to adverse effects on strength and durability of concrete. Unlike water addition, the incorporation of a superplasticiser not only reduces the inter-particle friction by dispersing cement particles but also maintains the deformation capacity and viscosity. It also imparts less influence on hardened properties than water. Particle size distribution also can affect the filling ability of

concrete. Concrete with continuously graded materials, aggregates and powder improves inter particle friction and gives the anticipated filling ability [90].

b) Passing ability - It is the ability of fresh concrete to flow through confined spaces and narrow openings (such as areas of congested reinforcement) without causing segregation or blocking. Passing ability determines how well the fresh mix will flow through constricted and confined spaces, narrow openings and between reinforcement. The determination of passing ability helps to evaluate the level of risk that the flow of the fresh mix will be impaired. Where structures are heavily reinforced, a good passing ability of SCC enables it to be placed and consolidated through dense reinforcing bars without any aggregate blockage [91]. Passing ability is linked to filling ability and the factors affecting the filling ability also influence the passing ability of concrete. In addition, the passing ability depends on the formwork geometry and the extent of congestion of the reinforcement. A good passing ability can be achieved by increasing the filling ability of fresh concrete and by limiting the segregation of coarse aggregates. This can be done by incorporating a viscosity-modifying admixture (VMA) along with a high range water-reducing admixture (HRWR) to control bleeding, segregation, and surface settlement [87].

c) Stability or Segregation resistance - It is the ability of concrete to resist separation of its constituent materials and maintain the uniformity of the mix throughout during the process of transport and placement [80]. Segregation is related to the cohesiveness of fresh concrete and can occur between water and solid materials or between paste and aggregate in both stationary and flowing states [88]. Segregation occurs when the coarse aggregate settles down and the free water rises to concrete surface. This free water is undesirable as it may be trapped by obstacles such as reinforcement bars or coarse aggregate that weakens the interfacial transition zone and ultimately affects the strength and durability of hardened concrete. A good segregation resistance can be attained in SCC by proper mixture composition. Segregation resistance can be enhanced by lowering the water-powder ratio and utilizing an increased amount of cementing materials or VMA along with HRWR. Segregation resistance of SCC can also be improved by limiting the size and content of coarse aggregate [75].

The above three properties are inter-dependent to each other in a way that a change in one property will cause change in to other properties. For example, lack of filling

ability and/or segregation resistance can cause insufficient passing ability. Therefore, adequate levels of all the three key properties must be reached for fresh concrete to be self-compacting.

2.9.1 Test Methods to evaluate the Fresh properties of SCC

Due to highly flowable nature of SCC, fresh concrete properties are significantly different from conventionally placed normal concrete. The high workability requirement of SCC does not allow using traditional methods for measuring the fresh state properties. A wide range of test methods have been developed to evaluate the fresh properties of SCC; however, so far no single test method has been found, which characterizes all the relevant workability aspects. The European guidelines EFNARC [92], has proposed five test methods to fully characterize an SCC mix. Table 2.8 lists the test methods along with their recommended values given by EFNARC [92]. The detailed description of these test methods is given below. Due to the lack of standardization of SCC test methods, the dimensions and details of the test methods may vary within the literature.

Table 2.8 Test Methods for Evaluating the Fresh Properties of SCC [92]

S.No.	Test Method	Characteristic	Typical range of values	
			Minimum	Maximum
1.	Slump flow	Filling ability	650 mm	800 mm
2.	T _{50 cm} slump flow	Viscosity/Flowability	2 sec	5 sec
3.	V-Funnel	Filling ability	6 sec	12 sec
4.	L-Box (H ₂ /H ₁)	Passing ability	0.8	1.0
5.	J-Ring	Passing ability	0 mm	10 mm

2.9.1.1 Slump Flow Test

This is the simplest and most commonly used test method for evaluating the flowability of SCC. This test is used to assess the flow rate of SCC in the absence of obstructions and gives a good assessment of filling ability. The basic equipment used in this test is the same as for the conventional slump test; however, the concrete placed into the mould is not rodded. Figure 2.27 provides a schematic of the testing apparatus.

To perform the test, about 0.2 ft³ (6 L) of SCC is needed. The slump cone is held in a firm position and is placed either in the conventional upright orientation or in inverted position. Both the positions of slump cone (with narrow end up or down) give almost the same slump value. After filling the slump cone, it is raised vertically and concrete is allowed to flow out freely. The diameter of the flow spread in two perpendicular directions is measured and the average of the two measured diameters is calculated. This is the slump flow in mm. The higher the slump flow value, the greater its ability to fill formwork under its own weight. There is no standardized threshold limit for the slump flow value, however, according to EFNARC guidelines [92], SCC is assumed of having a good filling ability and consistency if the diameter of the spread is in the range of 650 mm to 800 mm. This test can give lots of information about a typical SCC mix. Visual observations during the test can give additional information on the segregation resistance.

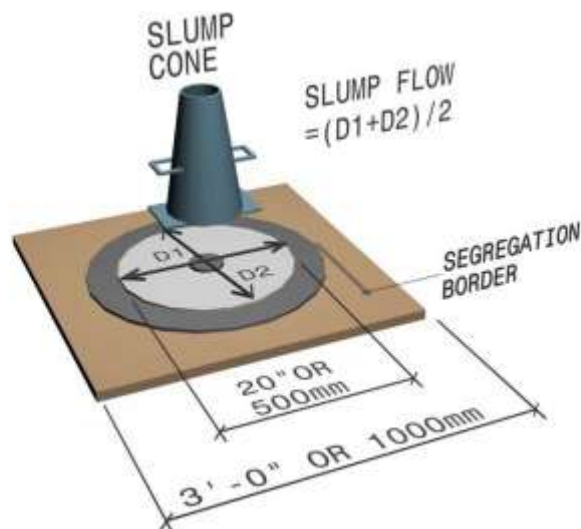

Figure 2.27 Slump Flow Test Apparatus

2.9.1.2 T_{50 cm} Slump Flow Test

At the time of performing the slump flow test, the time taken in sec. from the instant the cone is lifted to the instant when the flow spread reaches a 500 mm dia circle is recorded. This flow time, termed as T_{50cm} slump flow, gives an indication of the relative viscosity and provides a relative assessment of the unconfined flow rate of the SCC mixture [93]. A lower time indicates greater flow ability. Flow time up to 5 sec

is considered good for SCC. However higher time can also be obtained in case of very cohesive mixes. This test will generally not be used as a factor in rejection of a batch of SCC but rather as a quality control diagnostic test.

2.9.1.3 V-Funnel Test

This test is primarily used to measure the filling ability of SCC and can also be used to evaluate the segregation resistance. The equipment used in this test consists of a V-shaped funnel, as shown in Figure 2.28. To perform this test about 0.4 ft³ (12 L) of concrete is needed and the funnel is completely filled with concrete without tamping or compaction. After filling the funnel with concrete, the trap door at the bottom is opened and concrete is allowed to flow out under gravity and the time taken for the concrete to flow out completely through the orifice is recorded as the V-Funnel flow time. Shorter flow times indicate greater flowability and prolonged flow times may give some indication of the susceptibility of the mix to blocking. This may be due to high paste viscosity, high interparticle friction, or blockage of flow by coarse aggregates [90]. The funnel flow time between 6 and 12 sec is generally desired for SCC [92, 94]. This test is not suitable when the maximum size of the aggregate exceeds 20 mm.

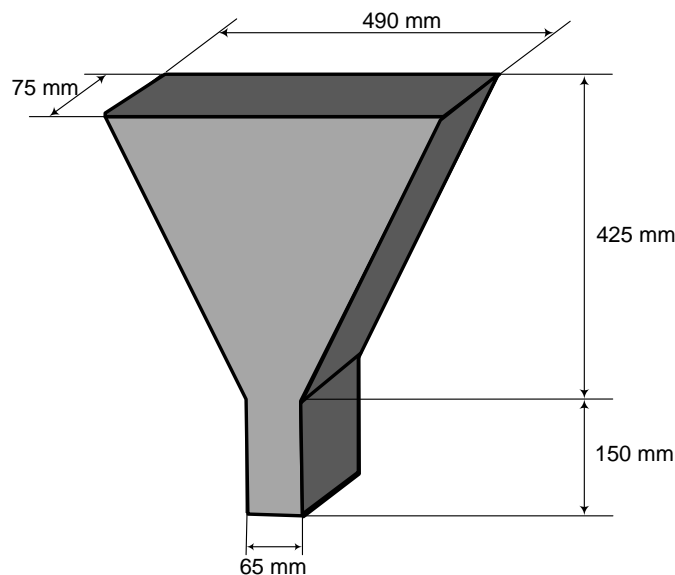

Figure 2.28 V-Funnel Apparatus

2.9.1.4 L-Box Test

The L-Box test is useful in assessing different parameters such as mobility, flow speed, passing ability and blocking behaviour. The apparatus (Figure 2.29) used in this test consists of a rectangular-section box in the shape of L, with a vertical and horizontal section separated by a moveable gate, in front of which vertical reinforcement bars are fitted. The spacing and size of the reinforcement bars depends upon the maximum size of the coarse aggregate. In this test, about 0.5 ft³ (14 L) of SCC is needed. To perform this test, the vertical section of the box is filled with concrete and the gate separating the vertical and horizontal compartments is then lifted, and the concrete is allowed to flow through closely spaced reinforcing bars at the bottom into the horizontal section of the box. When the concrete stops flowing and comes to rest in the apparatus, the heights of the concrete at the end of the horizontal section (H_2) and in the vertical section (H_1) are measured to compute the blocking ratio (H_2/H_1). This blocking ratio indicates passing ability of concrete or the degree to which the passage of concrete through the bars is restricted. Closer the value of H_2/H_1 to 1, the better will be the flow of the SCC. Various sources set different values for H_2/H_1 ratio but values between 0.8-1.0 are generally recommended [94].

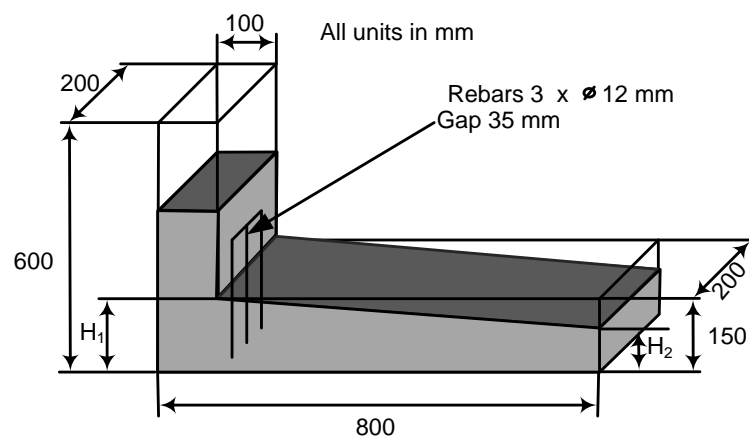

Figure 2.29 L-Box Test Apparatus

2.9.1.5 J-Ring Test

The J-Ring test is used to determine the passing ability of SCC. The J-Ring (Figure 2.30) is an open 300 mm diameter steel ring attached to vertical reinforcing bars. Each bar is 100 mm long and the spacing between reinforcing bars depend on the maximum

size of the coarse aggregate in the SCC mix. To conduct this test, the slump cone is placed in the center of the J-Ring and filled with concrete without any agitation or rodding. The slump cone is then lifted and concrete is allowed to spread horizontally through the gaps between the bars. Various interpretations of the test results have been suggested. To characterize filling ability and passing ability, the horizontal spread of the concrete is measured after the concrete passes through the bars of the J-Ring and comes to rest. The horizontal spread with the J-Ring to that without the J-Ring is then compared. Also, the difference in height of the concrete inside and that just outside the J-Ring is measured at four locations. In addition, Daczko [95] has suggested assigning a visual blocking index (VBI) rating, based on the appearance of the concrete after the test. Table 2.9 quantifies the blocking assessment based on VBI ratings.

Table 2.9 Visual Block Index Ratings [95]

VBI	Description
0	No evidence of blocking resulting in a pile of coarse aggregate in the middle of the patty and no evidence of bleed streaking behind the rebar obstacles.
1	A slight pile of coarse aggregate in the middle of the patty and slight evidence of bleed streaking behind the rebar obstacles.
2	A clear pile of coarse aggregate in the middle of the patty and significant bleed streaking.
3	Significant blocking of aggregate behind the rebar obstacles will usually result in a significant decrease in flow value.

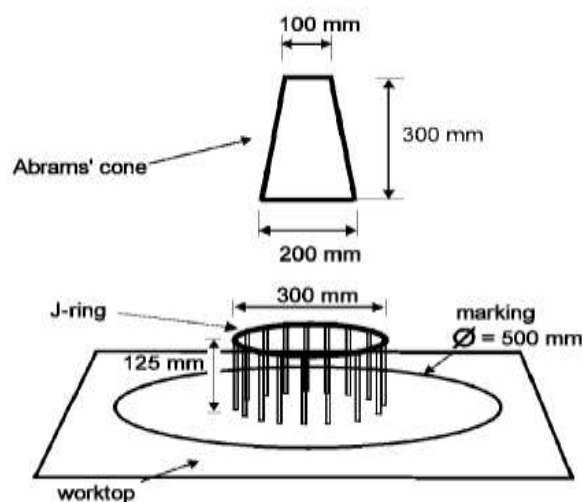

Figure 2.30 J-Ring Test Apparatus

2.10 Mechanical Properties of SCC

Although the fresh properties of SCC differ significantly from that of conventionally placed normal concrete, yet, the performance of SCC in terms of hardened properties may be comparable or even better than the equivalent conventional concrete [93]. The typical characteristics of SCC mix proportions, which are necessary to ensure adequate fresh properties, may have positive influence on hardened properties. The relatively low water/cementitious ratios, use of supplementary cementitious materials, and improved quality control measures may result in improved hardened properties. However, the reduced coarse aggregate content and increased paste volume may result in changes such as increased shrinkage and reduced modulus of elasticity.

A number of studies have been reported on the hardened properties of SCC. However, due to variety of approaches in comparing SCC and conventionally placed concrete, conclusions vary regarding the hardened properties associated with SCC. Some of the studies have reported that SCC's hardened properties are not equivalent to those of conventional concrete, while others have concluded that the properties are similar to or better than those of conventional concrete. In either way, it is obviously difficult to categorize SCC as always worse or better. However, it can be pointed out that hardened properties of SCC are primarily dictated by the mixture proportions and constituent materials used. If the proportions differ significantly from that of conventional concrete with which it is compared, then one should expect a difference in performance [96]. Although various mechanical properties have been evaluated and compared in literature, however, only the properties that are relevant to this research are discussed in the following sub-sections.

2.10.1 Compressive Strength

Compressive strength is the property of concrete that is most often specified for concrete design and quality control. It is universally accepted as a general index of concrete strength and a reasonable indicator of other properties. Various factors may influence the compressive strength of concrete; however, the water/cementitious material ratio and the porosity relationship best describe the compressive strength. SCC will usually have a slightly higher compressive strength when compared to

normal concrete of similar water/binder ratio. This is due to the improved interface between the aggregate and paste [11]. When normal concrete is vibrated, water will tend to migrate to the surface of the coarser particles causing porous and weak interfacial zones to develop [38]. On the other hand, well designed SCC will be homogeneous producing minimal interfacial zones to develop between the coarse aggregate and the mortar phase. Thus the microstructure of SCC can be expected to be improved, promoting strength, permeability, durability and ultimately a longer service life of the concrete [38].

Ashtiani et al. [97] made a comparison between the mechanical properties of a high strength SCC with a conventionally vibrated high strength concrete and assessed the compressive, splitting tensile and flexural strengths as well as modulus of elasticity for both types of concrete. For the same mixes with respect to the amount of binder and water/cement ratio, Ashtiani et al. [97] found that, at a given age, SCC mixes developed higher compressive strength than those of normally vibrated concrete due to better homogeneity and elimination of partial segregation resulting from vibration.

SCC mixes with a high volume of filler materials can also develop higher compressive strength, compared to those of vibrated concrete with the same water/cementitious material ratio and cement content [98]. According to Bosiljkov [98], filler materials such as lime stone act as nucleation sites that improve the microstructure of cement paste. Limestone filler not only results to an increased stability of the fresh SCC but also increases density of the paste matrix and improves interfacial transition zone in the hardened concrete resulting to an increase in the compressive strength of concrete. Heirman and Vandewalle [99] found that when a variety of fillers, including fly ash and mineral fillers, were used and the water/cement ratio was held constant, the compressive strength of SCC was generally higher than for conventional concrete.

Turk et al. [100] performed laboratory tests on eight SCC mixes and one control mix to investigate the mechanical properties of SCC with silica fume (SF) or fly ash (FA). Silica fume and fly ash were added separately as partial replacement of cement from 5% to 20% and from 25% to 40% at 5% intervals, respectively. Mechanical

properties such as compressive strength, splitting tensile strength, ultrasound pulse velocity and modulus of elasticity were investigated during the study. Utilization of different dosages of SF/FA was found to have positive effect on the mechanical properties of SCC. Test results demonstrated that SCC specimens with SF/FA had in general higher compressive and tensile strength than normal concrete specimens for all curing ages.

The rate of strength gain of SCC with age is not significantly different from that of a conventionally placed normal concrete containing the same proportion of cement and having the same water/cement ratio, except when filler materials such as limestone are used [101]. Holschemacher and Klug [83] studied the development of concrete strength with age by creating a database to evaluate the results of a large number of internationally published data on properties of SCC. Through analysis of the database, Holschemacher and Klug [83] found that the rate of strength development over time was generally similar for SCC and conventionally placed concrete; however, the use of limestone filler could accelerate the early development of strength whereas supplementary cementitious materials could increase the ultimate strength.

Sukumar et al. [65] replaced high volume fly ash in the powder, based on a rational mix design method to develop SCC. Strength development at different periods of curing such as 12 hrs, 18 hrs, 1 day, 3 days, 7 days, 21 days and 28 days were studied for various grades of different SCC mixes in comparison to the conventional concrete of same grades. It was observed that the rate of gain in strength for different grades of SCC was slightly more than the expected strength of conventional concrete of the same grades.

Al-Feel and Al-Saffar [102] carried out an experimental investigation to study the effect of curing regimes on the compressive, splitting tensile and flexural strengths of SCC and compared the same with that of normal concrete. SCC mixture was made with 92% Portland cement and 8% limestone powder. The water/binder ratio was fixed at 0.33. The specimens were cured either in the air or in water, for the period of 7, 14, and 28 days. The results indicated that the SCC gave higher compressive strength and high early strength compared to normal concrete for the entire curing

duration regardless of the curing condition. At 28 days, SCC mix achieved 30% higher compressive strength than normal concrete cured in water. The strength gain at 7 days was about 90% of 28-days compressive strength for SCC and 80% for normal concrete, while it was 96% for SCC at the age of 14 days. This was due to the addition of admixture, which improved the compressive strength regardless of curing condition and time.

2.10.2 Tensile and Flexural Strength

The tensile and flexural strengths of concrete depend on the characteristics of the microstructure of the cement matrix and of the interfacial transition zone between aggregate and cement paste [103]. The failure of concrete in tension is governed by micro cracking, associated particularly with the interfacial transition zone. The interfacial transition zone characteristics tend to affect tensile and flexural strength to a greater extent than compressive strength [104]. Since SCC contains more cementitious materials, the grain size distribution and packing density are improved and the porosity of the interfacial transition zone between aggregate and cement paste is decreased. Therefore, for SCC mixtures, one would expect higher tensile and flexural strengths than conventionally placed concrete [103].

Based on a database of results from around the world, Klug and Holschemacher [105] found that for a given compressive strength, the tensile strength of SCC was comparable to or slightly higher than conventionally placed concrete. Sonebi et al. [106] also found that splitting tensile strength of SCC at 28 days was higher than that of comparative normal concrete. Some other researchers [7, 102, 107] have made similar conclusions.

Al-Feel and Al-Saffar [102] reported that SCC mix achieved higher tensile and flexural strength values than those for normal concrete regardless of curing method. At 28 days, the splitting tensile strength for SCC cured in water or air was increased by about 25% while the flexural strengths were increased by 47% and 53%, respectively compared to that of normal concrete. This indicated that the type of curing was not so important for the development of tensile and flexural strength of SCC.

Felekoglu et al. [107] carried out an investigation on five SCC mixtures with different combinations of water/cement ratios and super plasticizer dosages. Slump flow, V-Funnel and L-Box tests were performed to determine the optimum parameters for the self-compactibility of SCC mixtures. Compressive strength, modulus of elasticity and splitting tensile strength of mixtures were also studied. The splitting tensile strengths of the SCC mixes were found to be higher and the values of modulus of elasticity were found to be lower than that of normally vibrated conventional concrete.

Dehn et al. [7] investigated the time development of SCC compressive and splitting tensile strength and the bond behaviour between the reinforcing bars and the SCC compared to normal concrete. Dehn et al. [7] reported that SCC mix specimens exhibited 36% and 28% higher compressive and splitting tensile strengths, respectively compared to conventional concrete specimens. Also, the bond behaviour was found to be better for SCC than that of normal concrete.

Because compressive strength is the principal material property that is measured for hardened concrete, the relationship between tensile and compressive strength is of particular interest. The ratio of the two strengths depends upon the general level of strength of the concrete. In general, as age and strength increase, the ratio of tensile/compressive strength decreases [72]. At similar water/powder ratios, the tensile/compressive strength ratio of SCC is 10-30% higher than that of normal concrete [108]. Turcry et al. [109] have also reported higher tensile/compressive strength ratio for SCC compared to conventional concrete. Turcry et al. [109] found that the ratio of tensile/compressive strength was between 0.087 and 0.1 for SCC and 0.075 for comparable conventionally placed concrete. Also, the flexural strength was slightly higher for SCC than a conventional mixture of comparable compressive strength. Domone [110] however reported that the ratio of tensile/compressive strength for SCC was similar to that for conventional concrete, with the great majority of cylinder splitting results for both types of concrete falling in the upper half of the range suggested in Eurocode 2.

2.10.3 Modulus of Elasticity

It is known that the modulus of elasticity of concrete typically depends on the proportion of individual components and their elastic modulus [77]. Among all the components of concrete, coarse aggregate is known to have the largest effect. The modulus of elasticity increases with high contents of coarse aggregate and decreases with increasing cement paste content [80, 83]. Thus, a relatively small modulus of elasticity can be expected for SCC, because of the high volume of paste and low content of coarse aggregates [83] but it appears to be no consensus in the literature regarding the modulus of elasticity of SCC. The modulus of elasticity of SCC has been studied and compared with that of normally vibrated concrete by many researchers; however, various studies on elastic modulus of SCC have resulted in contradictory results. These conflicting observations may however be explained by the fact that the constituent materials and rheological behaviour of SCC are quite different from that of traditional concrete.

Several researchers [83, 107, 110-113] have demonstrated that the modulus of elasticity of most SCC mixes was lower than that of traditional vibrated concrete of the same compressive strength. Based on a database of results from around the world, Holschemacher and Klug [83] found that for a given compressive strength, the modulus of elasticity of SCC was typically lower than for conventionally placed normal concrete. According to Holschemacher and Klug [83], the modulus of elasticity of SCC could be 20% lower than that of normally vibrated concrete having the same compressive strength and made of same aggregates. Felekoglu et al. [107] also found that SCC mixtures had lower modulus of elasticity when compared with conventional vibrated concrete, which was consistent with the lower coarse aggregate content in SCC mixtures. Leemann and Hoffmann [111] reported an average modulus of elasticity of SCC to be 16% lower compared with conventional concrete for an identical compressive strength. Similar observations were made by Roziere et al. [112]. The authors reported that the elastic modulus of the SCC mixtures decreased with an increase in volume of paste. Roziere et al. [112] found that increasing the paste volume from 29.1% to 45.7%, while keeping water/cementitious material ratio constant, reduced the 28-day modulus of elasticity by 14%.

Domone [110] reported that the elastic modulus of SCC could be up to 40% lower than that of normally vibrated conventional concrete for low compressive strengths of 20–30 MPa, however, the difference could decrease to less than 5% for high compressive strengths of 80–100 MPa. This behaviour was attributed to the relatively lower coarse aggregate quantities in SCC in comparison to normally vibrated concrete.

In contrast, some authors [106, 114-116] found no difference between SCC and ordinary concrete modulus of elasticity for comparable compressive strengths. Persson [114] reported that modulus of elasticity of SCC was the same as that of conventionally placed concrete when strength was held constant. A similar result was addressed by Mortsell and Rodum [115], who carried out a study where all mixture proportions for both SCC and conventional concrete were kept constant, indicating that there is no difference in modulus of elasticity for the two concretes. The basic difference in the preparation of the concrete mixtures was the higher dosages of chemical admixtures used in SCC. Similarly, Brameshuber and Uebachs [116] in their study reported that the modulus of elasticity of SCC and that of a normally vibrated concrete, produced from the same raw materials were found to be almost same. Although there was a higher paste matrix share in SCC, the modulus of elasticity remained unchanged due to the denser packing of the particles. Besides, Sonebi et al. [106] indicated that SCC mixes had the same relationship between modulus of elasticity and compressive strength as for the conventional concrete. The ratio of modulus of elasticity to square root of compressive strength ($E / f_c^{0.5}$) was close to 4.73 for both SCC and conventionally placed concrete.

2.10.4 Creep

Creep is a time-dependent deformation. It is the gradual increase in strain with time under a constant applied stress. Creep takes place in the cement paste and is influenced by porosity, water/cement ratio, cement content, and volume of aggregate available to restrain the creep [11, 72]. Due to higher volume of cement paste, the creep of SCC is anticipated to be higher than comparable normal concrete. However, no general statement about the creep of SCC can be made due to the contradictory

nature of existing data [83]. Although several studies have been conducted around the world on creep of SCC, however, most of the studies contain different conclusions. The different findings on the behaviour of SCC creep might be due to the difference in constituent materials, specimen sizes, test procedures, age of concrete, loading rate and others [75].

Attigbe et al. [117] studied creep of SCC and normal concrete under air and steam-cured conditions and found that the creep of SCC was greater than that of normal concrete under air curing conditions and the creep of SCC and normal concrete was similar under steam curing conditions. Persson [114] reported that the creep of SCC coincided well with that of normal concrete when the strength was held constant. Persson [114] carried out an experimental study on mechanical properties, such as compressive strength, elastic modulus, creep and shrinkage of SCC and the corresponding properties of normal compacting concrete (NCC). Eight mix proportions of sealed or air-cured specimens with water/binder ratio varying between 0.24 and 0.80 were prepared. Half of the mixes were SCC while others were NCC. The age at loading of the concretes in the creep studies varied between 2 and 90 days. The results indicated that elastic modulus, creep and shrinkage of SCC did not differ significantly from the corresponding properties of conventionally placed normal concrete. Some other researchers [118, 119] also found similar behaviour regarding the creep of SCC.

Seng and Shima [118] investigated the creep behaviour of SCC compared to that of conventional concrete. To do this, three SCC mixtures were evaluated against a control mixture, which was designed to have a compressive strength of 55 MPa. Prismatic specimens measuring 100 x 100 x 600 mm were cast with a 25 mm hole in the centre running the entire length. After removing from the moulds, the test specimens were air-cured at a constant temperature of $20 \pm 2^\circ\text{C}$ and relative humidity of $60 \pm 5\%$. The creep test specimens were loaded at 40% of the ultimate compressive strength over the duration of the test, which ran for just over 30 days. The authors concluded that SCC had comparable creep behaviour to that of conventional concrete. Additionally, the experimentally determined values of creep coefficients were compared with those calculated from ACI 209, CEB 90, and JSCE (Japan Society of Civil Engineers) 2002. The two researchers found large disparity between the

experimentally determined values and those obtained using each model. They concluded that none of these models work well for predicting creep of SCC mixtures containing high limestone filler contents.

Colleparidi et al. [119] used three mixtures (two SCC and one conventional slump mixture) to evaluate the creep performance of SCC versus conventional concrete. A similar amount of cement was used for each mixture; however, additional mineral additives were used in the SCC mixtures. Cubical specimens were cast and then cured at 20°C for 7 days, at which time they were tested in air having a relative humidity of 65%. For testing creep, the specimens were loaded to 25% of their ultimate strengths and creep strains were measured from 7 to 180 days. It was concluded that the SCC mixtures containing limestone filler experienced approximately the same creep that the conventional mixture exhibited; however, the fly ash mixture exhibited more creep than the control mixture. Colleparidi et al. [119] attributes the higher creep of the fly ash mixture to the presence of cenospheres within the fly ash, which were believed to have been deformed when the specimens were loaded.

In contrast, few researchers [120, 121] have shown that the creep deformations of SCC were lower than the corresponding normal concrete. The study conducted by Raghavan et al. [120] involved a comparison of the mechanical properties of an SCC mixture with those of a conventional concrete mixture. The same mix proportions were used for both types of mixtures. The test specimens (150mm x 300mm) were cured at 23°C for 7 and 28 days air curing after removing from their moulds. The creep test specimens were loaded at 30% of ultimate load and creep strains were measured for a period of 90 days for the 7 day cured specimens and 70 days for the 28 day-cured specimens. Raghavan, et al. [120] reported that SCC mixture experienced a higher initial elastic deformation; however, the total creep strain measured over the entire testing period was lower, compared to normal concrete. Additionally, it was reported that the rate of creep was reduced by 33% for the normal concrete and 50% for the SCC between non accelerated-cured times of 7 and 28 days.

Poppe and Schutter [121] studied the creep and shrinkage behaviour of SCC made with different parameters like cement type, filler type, and cement to powder ratio. They found a decrease of the creep deformation. The decrease in the creep coefficient

resulted from the increased water/cement ratio. They pointed out that combination of water/cement and water/powder ratio should be taken in to regard for time-dependent deformations. It was also concluded that shrinkage values of SCC are comparable to that of ordinary concrete.

2.10.5 Drying Shrinkage

Shrinkage represents the strain caused by the loss of water from hardened concrete [72]. There are several factors, which affect shrinkage of concrete. Microstructure of the paste, paste content, and the water/cement ratio are the most important factors that influence the mechanism and the magnitude of creep and shrinkage [121]. Due to the fact that SCC in general contains higher volume of paste and lower content and size of coarse aggregate than normal concrete, similar to creep, the drying shrinkage is generally expected to be higher for SCC than conventional concrete. So far, a number of studies have been conducted around the world to evaluate the shrinkage behaviour of SCC compared to conventionally placed concrete, however, many of the publications contain very different statements. Some researchers have reported higher drying shrinkage in SCC compared to normal concrete while others have reported otherwise. Several factors can explain these opposite conclusions. These may include utilization of different mix proportions, experimental procedures with different curing conditions, specimen sizes, material properties etc.

Based on a study on international database, Klug and Holschemacher [105] reported that the drying shrinkage of SCC was typically 10-50% higher than that of normal vibrated concrete. Similar findings have been reported by Kim et al. [122] and Rols et al. [123]. Kim et al. [122] studied the drying shrinkage of SCC and conventional concrete made with fly ash in which the paste fraction and volume ratio of coarse aggregate-to-concrete varied. Results indicated that with increasing unit water weight and decreasing volume ratio of coarse aggregate-to-concrete, the drying shrinkage was increased. The reported results from this experiment indicated that the drying shrinkage for SCC was 30 to 50% greater than conventional concrete. The authors believed that the higher drying shrinkage for the SCC mixtures was due to the higher paste volumes, higher water contents, and less coarse aggregate. Additionally,

Rols et al. [123] found that the drying shrinkage values for SCC were about 50% higher than conventional concrete containing the same amount of cement. It was deduced that the increase in drying shrinkage was due to the increase in the paste fraction and decrease in coarse aggregate.

However, it was reported that SCC's denser microstructure restrains drying shrinkage and a reduction in the shrinkage of SCC was found [120]. Application of limestone filler in SCC was also found to show a reducing effect on shrinkage [124]. Raghavan et al. [120] reported that the conventional concrete specimens exhibited more drying shrinkage than the SCC specimens. The same materials were used for both types of mixes except that SCC consisted a lower water/binder ratio and a higher sand/aggregate ratio. In addition, the water weight for the conventional concrete and the SCC was the same in all cases. The results indicated that the drying shrinkage of SCC was 25% less than conventional concrete. It was believed that this reduction in shrinkage was due to the effect of paste volume and decreased water/binder ratio. Bui and Montgomery [124] also reported that reducing the water/binder ratio and paste volume and the use of limestone filler reduced the drying shrinkage of SCC compared to conventionally placed concrete.

Other studies [125, 126] reported that the drying shrinkage of SCC did not differ from that of normally vibrated concrete when the compressive strength was kept same. Sheinn et al. [125] performed an experimental study on mechanical properties of SCC and that of equivalent normal concrete. A total of six concrete mixes (three SCC and three conventional concrete), targeting three different mean strength levels of 40, 60 and 80 MPa were designed and investigated. Sheinn et al. [125] concluded that SCC exhibited similar mechanical performance and behaviour in terms of hardened properties and long-term deformation as normal concrete at similar strength levels. The authors reported that the drying shrinkage strains of SCC were slightly lower than that of conventional concrete. This was due to the incorporation of fine filler granite dust in SCC, which enhanced the filling effect resulting in reduction of porosity in the specimen. Also, the larger aggregate sizes (22 mm) used in the SCC mixes enhanced the aggregate skeleton or restrained in SCC specimen.

Bouzoubaa and Lachemi [126] carried out an experimental investigation to evaluate the performance of SCC made with high volumes of fly ash. Nine SCC mixtures and one control concrete were designed during the study. The SCC mixtures had a cement replacement of 40%, 50%, and 60% by Class F fly ash. The mechanical properties of hardened concrete such as compressive strength and drying shrinkage were determined. For drying shrinkage test, four prismatic specimens measuring 76 x 102 x 390 mm were cast from each mix. The prisms were stored in lime-saturated water for 7 days prior to be transferred to a conditioned chamber at $20 \pm 2^\circ\text{C}$ and 50% relative humidity. Bouzoubaa and Lachemi [126] reported that the drying shrinkage strains of SCC did not differ from that of control concrete. At 224 days, the drying shrinkage of SCC mix specimens ranged from 504 to 595 microstrains in comparison to 541 microstrains observed for conventional concrete.

2.11 Self-compacting Geopolymer concrete

Self-compacting Geopolymer concrete (SCGC) is relatively a new concept and latest advancement in the field of concrete technology. It is a novel material that involves innovation in the production and casting of concrete. SCGC is a type of concrete that does not require compaction for placing it and can be produced by complete elimination of OPC. It can be made using materials rich in silica and alumina such as fly ash and sodium hydroxide and sodium silicate as alkaline activator together with superplasticizer. SCGC represents an opportunity to simultaneously improve both environmental and engineering performance compared to traditional Portland cement concrete. Replacing Portland cement with abundantly available waste material such as fly ash and placing the concrete without external vibration may prove to be the most effective way of resource conservation, environmental protection and time & labour saving. An important improvement of health and safety can also be achieved through reduction of global warming due to green house gas CO_2 emission from Portland cement manufacturing, elimination of handling of vibrators and a substantial reduction of environmental noise loading on and around a site. The development of an environmental friendly SCGC with acceptable fresh and hardened properties would be extremely helpful for the sustainable development and would provide many benefits to the construction industry.

2.12 Summary of Literature Review

In this chapter, a comprehensive review of available and related published literature on geopolymer concrete and SCC was presented. From the review of existing literature, it is observed that geopolymer technology has become a viable technology and geopolymeric materials are considered as the cements of the future due to their low ecological impact and relatively high yield from raw materials. These materials, which are produced by dissolution of solid aluminosilicate base material like fly ash in highly alkaline activator solutions, are promising materials, and possess remarkable physico-chemical and mechanical properties. With correct mix design and formulation development, these materials can show a wide variety of valuable characteristics than the traditional Portland cement concrete.

The earlier research also shows that SCC, an emerging technique of concrete, is gaining popularity throughout the world and there is a rapidly increasing trend towards SCC. The ability of SCC to flow under its own weight and passing through the reinforcement without the need of any internal or external vibration offers several advantages in technical, economic, and environmental terms over conventional concrete. These include an improved quality of concrete, reduced construction time, easier placement in congested reinforcements, uniform and complete consolidation, increased bond strength, reduced noise levels due to absence of vibration, lower overall costs, and safe working environment.

Literature review indicated that until now, a number of studies have been done on the performance of geopolymer concrete, which shows several advantages over conventional concrete. However, despite all positive remarks on geopolymer concrete, there exist some concerns about geopolymer concrete, which need to be addressed. Geopolymer concrete because of cohesive nature is known to have low workability and hardens immediately when mixed. The lack of sufficient workability in case of inaccessible or heavily reinforced sections makes the concrete difficult to fill the formwork properly and weakens the bond between the concrete and reinforcement, consequently lowers the ultimate performance of concrete. The current research is therefore projected from conventional vibrated geopolymer concrete to SCGC to address the above problems. By making geopolymeric concrete as self-compacting,

the combined advantages arising from the two types of concrete can be achieved. Thus, an experimental program has been designed to fill in the gap of present knowledge and understanding of the mechanical behaviour of SCGC. This will help to provide an opportunity for further explorations into SCGC and will facilitate the implementation and wider use of this potential material in construction industry. The development of SCGC mixture design with the details of the materials, mixing procedure, and casting and curing conditions are described in the next chapter. Interpretation of experimental results and conclusions are made in the subsequent chapters.