

WAVE HYDRODYNAMIC INTERACTION STUDY ON
ARTIFICIAL REEF BREAKWATER

MUHAMMAD ASRAF BIN RAFLI

CIVIL ENGINEERING
UNIVERSITI TEKNOLOGI PETRONAS

SEPT 2016

Wave Hydrodynamic Interaction on Artificial Reef Breakwater

by

Muhammad Asraf Bin Rafli

17128

Dissertation submitted in partial fulfilment of the requirements for the
Bachelor of Engineering (Hons)
(Civil Engineering)

SEPTEMBER 2016

Universiti Teknologi PETRONAS

Seri Iskandar

32610

Perak Darul Ridzuan

CERTIFICATION OF APPROVAL

Wave Hydrodynamic Interaction on Artificial Reef Breakwater

by

Muhammad Asraf Bin Rafli

17128

A project dissertation submitted to the
Civil Engineering Programme
Universiti Teknologi PETRONAS
in partial fulfilment of the requirements for the
BACHELOR OF ENGINEERING (Hons)
(CIVIL ENGINEERING)

Approved by,

.....

(Dr Siti Habibah Shafiai)

UNIVERSITI TEKNOLOGI PETRONAS

SERI ISKANDAR, PERAK

September 2016

CERTIFICATION OF ORIGINALITY

This is to certify that I am responsible for the work submitted in this project, that the original work is my own except as specified in the references and acknowledgements, and that the original work contained herein have not been undertaken or done by unspecified sources or persons.

MUHAMMAD ASRAF BIN RAFLI

ABSTRACT

Coastal areas have provided strategic and easy access from long distance and save time especially in onshore activities. Meanwhile, coastal areas continuously undergo dynamic processes with the contribution of two natural processes, which are erosion and accretion that shape the coastline. As long as no interference from the man's intervention, the coastline is actually stable. After many years, the rapid development and urban navigation at coastal area interfere both of process and led to erosion problem. The erosion problem can be controlled by implementing coastal structures. The construction of coastal structure may disturb the habitat of the aquatic life in the shallow area. In this project, the breakwaters were to be designed as the habitat for fish communities and combine with the concept of artificial reef that currently used in fish enhancement purpose. Therefore, a proper new design of the breakwater will have a function like artificial reef to provide a shelter area of aquatic life. Furthermore, this project aims to investigate the interaction of wave transmission and frequency transmission to the new design of breakwater. The general dimensions of the test model are 30 cm length x 28 cm width x 7 cm height. The multifunctional breakwaters constructed by using concrete. The depth of water in the flume is 10 cm. It was used to assess the performances of breakwater in the shallow water. For shallow water, the water depth must less or equal to one-twentieth ($1/20$) of the wavelength. At 0.8s-0.9s, the result represents the acceptable wave transmission coefficient values. It shows that breakwater-artificial reef mainly attracting fish. However, at 0.9s -1.1s, the results illustrate uncertainty values. The breakwater type called "Circle" gives better performance compared to other breakwater models in term of wave transmitted frequency, ft . Further research especially conducting more tests and design shapes for better understanding and performances.

ACKNOWLEDGEMENT

First and foremost, I would like to praise and thanks Allah S.W.T for His blessings and the strength He granted me, I am able to finish my Final Year Project I & II for fourteen (14) weeks. I am using this chance to extend my thankful to my university, Universiti Teknologi PETRONAS for giving me opportunity in being part of this company, able to gain learning lifestyle in this university.

Next, I would like to give special thanks to my UTP'S Supervisor, Dr Siti Habibah Shafiai for her aspiring, assistance and valuable advices throughout my Final Year Project in the university. Furthermore, big appreciation I give to all laboratory technicians and Msc Students for helping along to finish my Final Year Project.

My appreciation also goes to Civil Engineering's respective lecturers, seniors and colleagues because of sharing in their knowledge as well as making this opportunity become a success. Apart from that, this chance has given me many experiences in the engineering field and real working environment that useful for me. Not forgetting, my FYP's coordinator, excellent supervision along the assessment and allowing me to achieve good presentation will be more appreciated.

Lastly, special thanks to my family because of their supporting and willingness to give motivation that strengthen me in enduring this long period of industrial internship. Without their support, it is very difficult to improve the performances during my studies.

Table of Contents

CERTIFICATION OF APPROVAL	i
CERTIFICATION OF ORIGINALITY	ii
ABSTRACT.....	iii
ACKNOWLEDGEMENT	iv
LIST OF FIGURES	vii
LIST OF TABLES	viii
Abbreviations and Nomenclature.....	ix
Chapter 1	10
INTRODUCTION	10
1.1 Background	11
1.2 Problem Statement	12
1.3 Objectives.....	14
1.4 Scope of Study	14
Chapter 2	16
LITERATURE REVIEW.....	16
2.1 Breakwaters.....	16
2.1.1 Mound Breakwater.....	16
2.1.2 Monolithic Types	17
2.1.3 Composites types	18
2.2 Stability On Submerged Breakwater.....	19
2.3 Appraisal of Breakwater Performance	20
2.3.1 Wave Reflection.....	20
2.3.2 Regular Waves	20
2.3.3 Wave Transmission on breakwater	21
where, H_t and H_i are transmitted and incident wave height respectively	21
2.4 Artificial Reef.....	21
2.5 Effectiveness of Artificial Reefs	22
2.6 Assessment of Artificial Reef Performance	23
Chapter 3	24
METHODOLOGY.....	24
3.1 Breakwater Design	24

3.2 Test Facilities and Instrumentations	27
3.3 Experimental Set up	28
3.4 Test Programme	30
3.5 Research Methodology.....	31
3.6 Gantt Chart	32
3.7 Key Milestone	33
Chapter 4	34
RESULT AND DISCUSSION	34
4.1 The Effect of Wave Period on Coefficient of Wave Transmission	35
4.2 Comparison Between Frequency Transmitted and Frequency Generated	37
4.3 Wave Structure Interaction	38
Chapter 5	42
CONCLUSION AND RECOMMENDATION	42
REFERENCES.....	43

LIST OF FIGURES

Figure 1 : The famous coastal tourism destination in Malaysia, Vietnam, Cambodia, and Thailand [4]	11
Figure 2 : Breakwater at Mina Al Fajr	12
Figure 3 : Seawalls disturbing sea turtles nesting habitat [9].....	13
Figure 4 : Tires used in the sea for habitat of fish [10].....	13
Figure 5 : The theory of wave	14
Figure 6 : The theory of wave dissipated after hit the breakwater.....	15
Figure 7 : Monolithic Breakwater	18
Figure 8 : Types of artificial reefs [14]	22
Figure 9 : Primary wave dissipation mechanism of the breakwater	26
Figure 10 : HM 160 Experimental Flume 86 x 300 mm used in the experiment	28
Figure 11: Side view (first) and upper view (second) of the artificial reef breakwater in the flume	29
Figure 12 : The side view of breakwater in the HM 160 flume.....	30
Figure 13 : Flow chart of the project while carry out the study.....	31
Figure 14 : Key Milestone of the project	33
Figure 15 : (a) The set up of the test model of breakwater and (b) the location of wave height that will be measured the experiment	34
Figure 16: The graph of wave transmission, Ct between wave periods, T	37
Figure 17 : The graph of frequency transmission, f and frequency incident, f	38
Figure 18 : Formation of Eddie on the Non Shape Breakwater at 13s	39
Figure 19 : Formation of Eddie on the Rectangular Breakwater at 13s.....	39
Figure 20 : Formation of Eddie on the Circle Breakwater at 13s	40
Figure 21 : Formation of wave overtopping over the breakwater.....	40
Figure 22 : Wave run up at the front of breakwater.....	41

LIST OF TABLES

Table 1 : Types of Mound Breakwater	17
Table 2 : Type of Composite breakwaters	19
Table 3 : The design of breakwater constructed by using AutoCAD and has been tested in the flume.	25
Table 4 : The design of breakwater fabricated by using concrete.....	26
Table 5 : Accessories in HM 160 Experimental Flume	28
Table 6: Gantt chart of the project	32
Table 7 :Wave transmission, C_t of different model of breakwater.....	36

Abbreviations and Nomenclature

H_i	Incident Wave Height
H_t	Transmitted Wave Height
C_t	Coefficient of Wave Transmission
C_r	Coefficient of Wave Reflection
H_r	Reflected Wave Height
w	Angular Frequency
f	Frequency
T	Time Period
f_i	Incident Frequency
f_t	Transmitted Frequency
$\frac{rad}{s}$	radian per second
%	Percentage

Chapter 1

INTRODUCTION

The tourism development in a country has made the coastal areas become the main attraction of economic growth in the tourism sector. Coastal areas have become a major contributor for food industry, especially in supplying marine products as well as fisheries industry [1]. Coastal areas have provided strategic and easy access from long distance and save time especially in onshore activities. Therefore, coastal areas are a very valuable asset that must protect by human to ensure coastal areas sustained and developed by the next generation. Many large cities have been developed within coastal zones, for example Shanghai, Bangkok, Tokyo, Hawaii, London and New Orleans [2]. As stated by Nordin [3], the coastal zones has a special socio-economic significance. Moreover, the coastal zones are also the centre of economic activities encompassing urbanization, agriculture, fisheries, aquaculture, oil and gas exploitation as well as transportation and communication [4]. Figure 1 represents the famous coastal tourism destination in Malaysia, Vietnam, Cambodia and Thailand [4].



Figure 1 : The famous coastal tourism destination in Malaysia, Vietnam, Cambodia, and Thailand [4]

1.1 Background

Coastal areas continuously undergo dynamic processes with the contribution of two natural processes, which are erosion and accretion that shape the coastline. As long as no interference from the man's intervention, the coastline is actually stable. After many years, the rapid development and urban navigation at coastal area interfere both of equilibrium processes and led to the erosion problem. The erosion problem can be controlled by implementing coastal structures to reduce the threat from the erosion. Sometimes, the coastal structure has an immediate short term or a long lasting environmental impact. One of example of coastal structure is a breakwater which is installed on the foreshore or offshore to create calm areas landward of the structures. Normally, breakwater placed away from the shoreline. Besides, breakwater also designed for navigation channel to allow the movement of big ships to shelter the things especially at the port [5].



Figure 2 : Breakwater at Mina Al Fajr

Man-made coastal structures such as breakwater, groynes, and jetties known plays an important role in coastal systems by supporting diverse and abundant communities of aquatic life [6]. Figure 2 shows the breakwater at Mina Al Fajr. According to John [6], he found that fish are use these structures for habitat and has enhanced local abundance and biomass. Fish community development varies according to materials used in coastal structures [6]. Majority of artificial reefs and coastal structures around the world are constructed from concrete [6]. After that, artificial reefs are man-made structures that serve as shelter and habitat, source food, breeding area, and shoreline protection [7]. If breakwaters are to be designed as the habitat for fish communities and combine with the concept of artificial reef that currently used in fish enhancement purpose.

1.2 Problem Statement

The construction of coastal structure may disturb the habitat of the aquatic life in the shallow area. According to Bulleri and Chapman [8], a man-made coastal structure such as sea walls, rock revetments and others can negatively affect the coastal ecosystems and wildlife by interfering with natural beach shaping forces and disturbing habitat. One of example of a coastal structure like sea walls directly threaten sea turtles by reducing or degrading suitable nesting habitat [9] based on Figure 3. It will lower the optimal nesting area for sea turtle and affect their species.



Figure 3 : Seawalls disturbing sea turtles nesting habitat [9]

In some cases, breakwater habitats can develop fish communities with abundance and richness comparable to that of natural coral reefs and indicate that breakwaters are an important ecosystem for coral reef fishes in the Gulf [6]. There were some initiatives done to create new aquatic habitats by materials from old tires. However, tires are not readily broken down in the marine environment and also posed a difficult disposal problem for solid waste managers given already crowded landfill areas [10]. Figure 4 represents tires used in the sea for habitat of fish which is not good for aquaculture community.



Figure 4 : Tires used in the sea for habitat of fish [10]

Therefore, a proper new design of the breakwater will have a function like artificial reef to provide a shelter area of aquatic life. It can be called Artificial Reef Breakwater.

1.3 Objectives

The objectives of the study are included:

- I. To study and design new breakwater similarly to artificial reef function
- II. To investigate the interaction of wave transmission and frequency transmission to the new designed breakwater
- III. To analyze the wave hydrodynamics interactions with different shapes of new designed breakwater structure

1.4 Scope of Study

The project will involve the study will focus on the performance of artificial reef breakwater in wave transmission and frequency transmission. Coastal processes affected by interaction between waves and breakwater models. Figure 5 represents the theory of wave and the identity of wave travel on the sea.

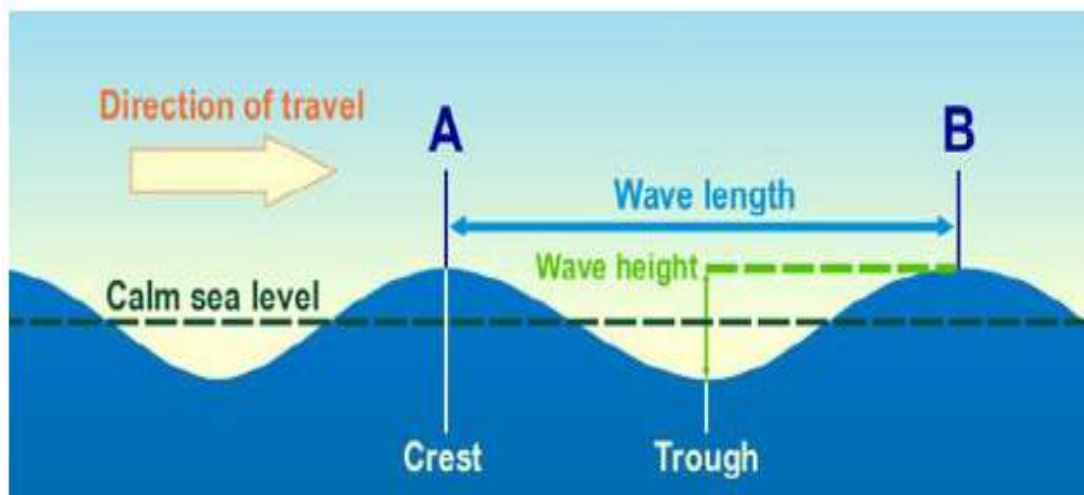

Figure 5 : The theory of wave

This study will focus on the impact of incident and reflected wave towards the breakwater. Figure 6 shows the theory of wave travel and hit the breakwater which is reducing the size or energy of wave.

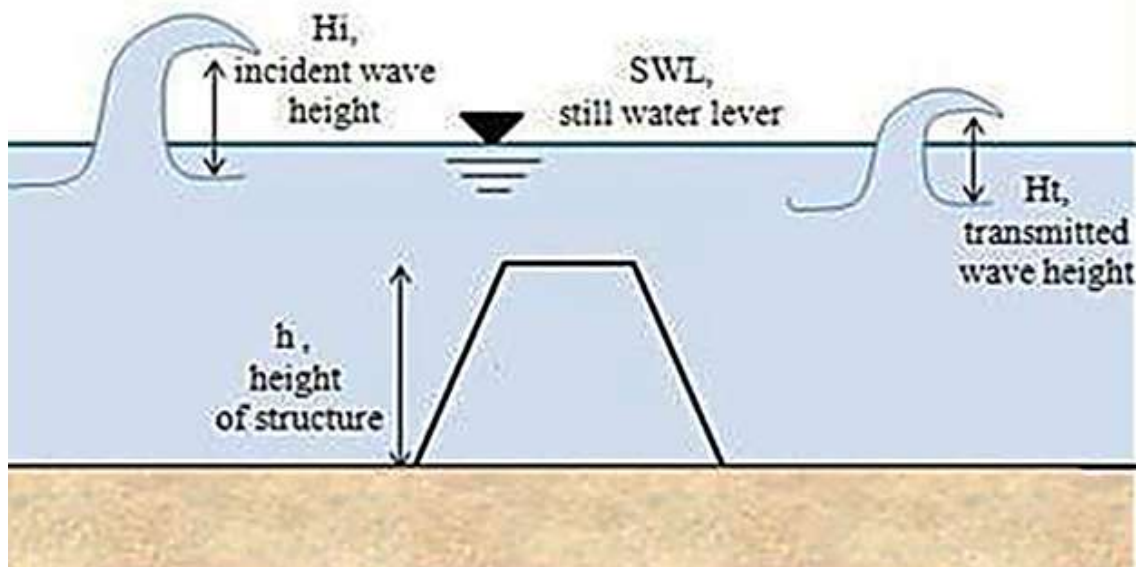

Figure 6 : The theory of wave dissipated after hit the breakwater

Chapter 2

LITERATURE REVIEW

Coastal erosion are natural processes occurred due to the wind wave action. There are two types of solutions to mitigate coastal erosion problems which are namely structural or engineering solutions and non-structural solutions [5]. Structural or engineering solutions involving hard engineering solutions such as construction of breakwater, revetment, seawalls and groins. At the same, the structural solutions also interrupt coastal ecosystem especially in shelter area of aquatic life. Artificial reefs are man-made structures that serve as shelter and habitat, source of food, breeding area and shoreline protection [7]. It used in many countries to enhance their production of fish which is increasing from year to year.

2.1 Breakwaters

Breakwaters are structures located in the water and used to protect the coastal area from undesirable wave heights. There are several types of breakwater such as Mound types, Monolithic types and Composite types.

2.1.1 Mound Breakwater

Mound breakwater is armoured by double or single layer of which dissipating the wave energy. According to Fousert in 2006, the mound breakwater is an attractive to apply if the loose elements (rock and concrete) are available near breakwater location and shallow water at depths less than 10 meters [11]. If this mound of breakwater constructs at deep water, the cost is higher due to enlarge the size of breakwater compatible the high wave energy. In Mound breakwater, there are three designs commonly used in coastal area which are:

1. Rubble Mound Breakwater
2. Submerged Breakwater
3. Berm Breakwater

Table 1 : Types of Mound Breakwater

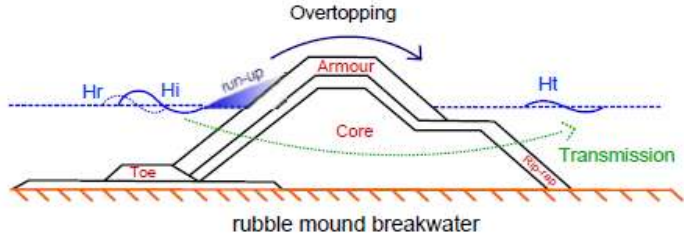
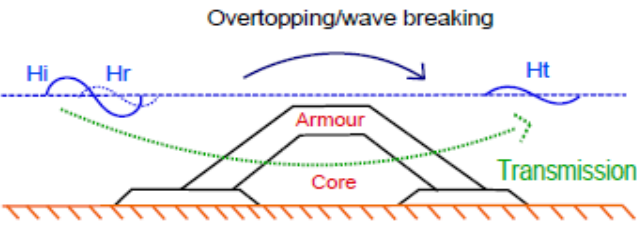
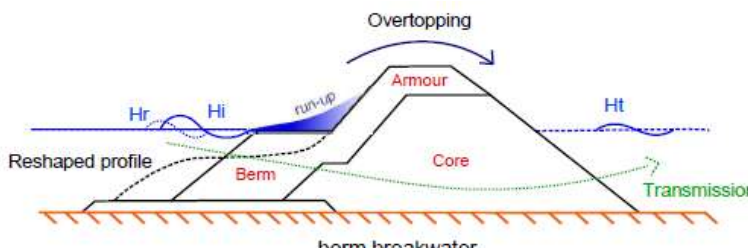
Type of Mound breakwater	Design
Rubble Mound Breakwater	
Submerged Breakwater	
Berm Breakwater	

2.1.2 Monolithic Types

Monolithic of breakwater has a cross section of one large solid block. It is suitable for depth of less than 24 meters and also cheaper than mound breakwater

[11]. However, coastal engineering must aware with the soil condition and it must appropriate to enable the stable foundation of this design.

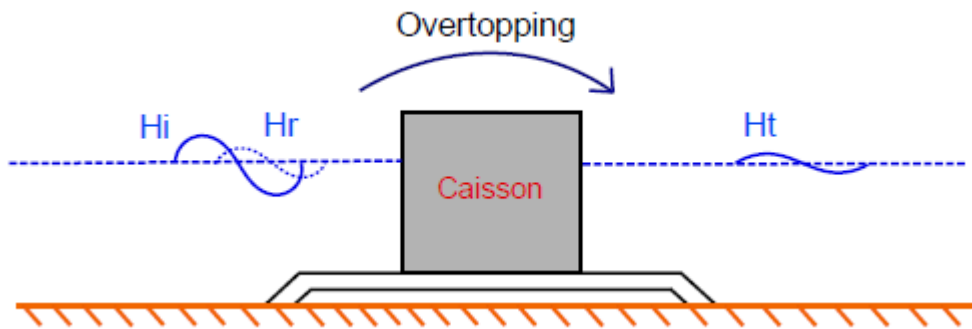
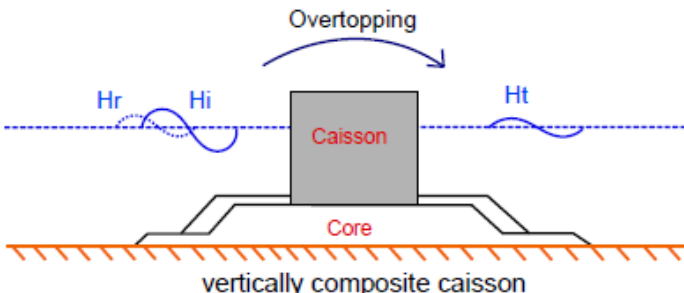
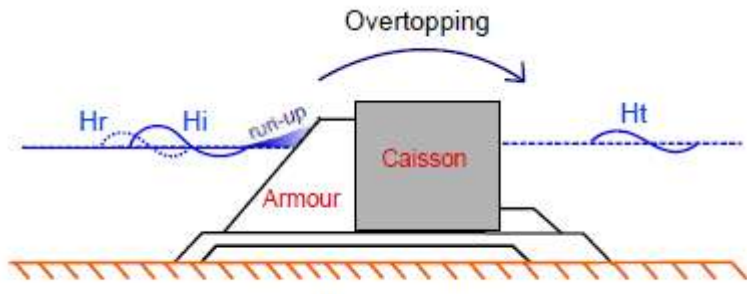

Figure 7 : Monolithic Breakwater

2.1.3 Composites types

A composite breakwater is the combination of low-crested berm breakwater with monolithic breakwater. It is good applicable in the depth of 24 metres till 32 metres. It is also need to consider the soil condition and ensure the stability to sustain in long term.

Table 2 : Type of Composite breakwaters

Type of Composites breakwater	Design
Vertically Composite Caisson	
Horizontally Composite Caisson	

2.2 Stability On Submerged Breakwater

The construction of submerged breakwater highly prefers in order to control the coastal erosion, trap natural sediments and restore the beach as well as lower construction cost and significant influence in dissipation wave energy [12]. Research had been done to the armour layer stability of the low crested breakwater, one of them is Van der Meer and Daeman in 1994. They found that the hydraulic stability of low crested and submerged breakwaters with rock armour is increasing with decreasing crest level. Furthermore, they stated that a crest level of the water line leads to 20% to 30% increase the armour layer stability; a crest level below the water line (submerged breakwater will further increase the armour stability of the rock armour).

2.3 Appraisal of Breakwater Performance

The wave is generated by wind, submarine disturbance and the gravitational attraction of the sun and the moon. The transmission of energy is caused by the movement of water particles in the water body. Same as light and sound waves, water waves undergo the same transformation phenomena. There are several types of waves transformation including wave reflection, energy loss and regular waves, random waves and regular waves.

2.3.1 Wave Reflection

Wave reflection occurs when energy is reflected as the waves hit into a rigid obstruction such as a breakwater, seawall, and cliff. This is especially obvious where the surface is a smooth vertical. The amount of reflected can be identified by reflection coefficient, C_r

$$C_r = \frac{H_r}{H_i}$$

where H_r and H_i are reflected and incident wave height respectively.

If the 100% the energy is reflected (total reflection), the C_r is equal to 1. If the structure is vertical and permeable rigid wall, reflected wave energy can be large. However, a gentle slope or permeable structure causes the reflected wave energy turn to small.

2.3.2 Regular Waves

Regular waves is waves repeat itself overtime wherein the vertical displacement of the water surface is the same over a certain period and distance. The vertical displacement of the sea surface is described as a function of horizontal coordinates x , y , and time T . The T is called the period of the waves. The angular frequency is $w = \frac{2\pi}{T}$, the frequency is $f = \frac{1}{T}$, its unit is $\frac{rad}{s}$. The period of waves influenced by the speed of the waves. The waves with the longest period propagate faster than the ones with smaller period.

2.3.3 Wave Transmission on breakwater

The effectiveness of a breakwater in attenuating wave energy can be measured by the wave energy that is transmitted past the permanent structure. The greater the wave transmission coefficient, the lesser will be wave attenuation ability. Wave transmission is quantified by the wave transmission coefficient,

$$C_t = \frac{H_t}{H_i}$$

where, H_t and H_i are transmitted and incident wave height respectively

2.4 Artificial Reef

Artificial reef is one of alternative acts as habitat for aquatic life an usually submerged in seawater. According to Baine [13] in 2001, artificial reefs have been traditionally deployed for fisheries stock enhancement. Besides, artificial reefs are constructed of concrete, steel, and sometimes they used tires to reduce the cost. The artificial reefs provide fish and other sea creatures shelter and habitat where they can find some food and use it as breeding area [14]. According to Armono in 1999, most of artificial reefs have rectangular shapes and causing tearing of fishing nets. In order to reduce entanglement of fishing nets, bottom-seated smooth-shaped reefs were proposed as alternatives such as cylindrical shapes, turtle blocks, and reef balls [15].

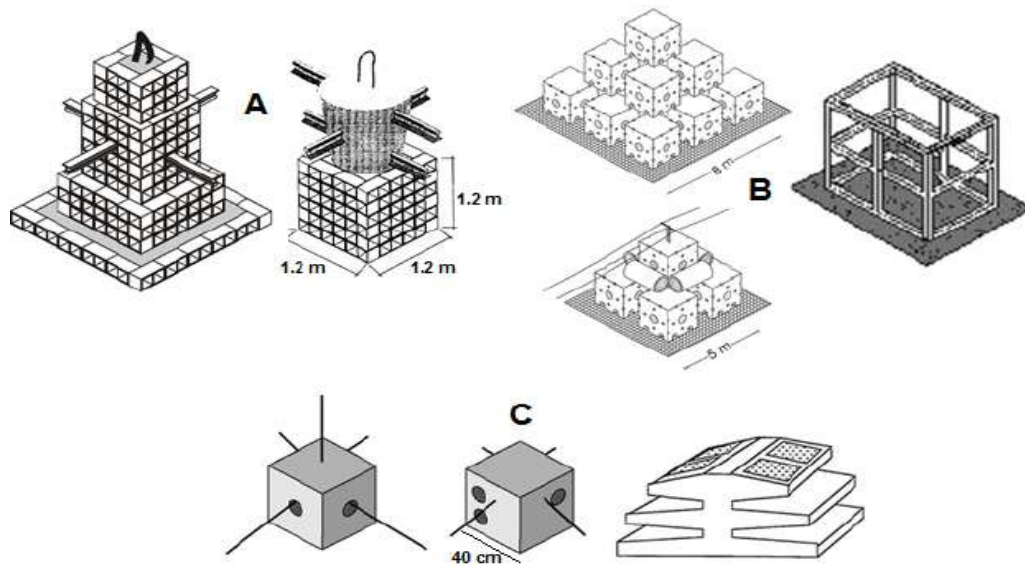

Figure 8 : Types of artificial reefs [14]

2.5 Effectiveness of Artificial Reefs

The most effective and most often used materials have been concrete blocks and scrapped boats [16]. Artificial reefs provide shelter, feeding, spawning, playing grounds, rest real and temporary stop-over for fish and create their local ecological system. Nakamura stated that pressure waves created by currents impinging on solid reef structures are recognized by fishes and provide them an orientation to the reefs.

Some studies were carried out on physical aspects of artificial reef and conducted by researchers. They were mostly directed towards biological environmental aspects performed by biologist and marine scientist in the areas of i) assemblage fish in the reef vicinity , ii) reef productivity, iii) comparative studies, between artificial and natural reefs [14]. Among of those studies on physical aspect of artificial reefs are carried out by Lindquist and Pietrafiesa in 1989 who observe generation of current vortices and tubulence vicinity of reef that attract fish, while Bohnsack et al. In 1994 noted that fish tended to face into the current to maintain its position while capturing the food [14]. The turbulence over the reef which is combining with the friction of water created among the reefs will reduce the energy passing the reefs by wave breaking [14].

2.6 Assessment of Artificial Reef Performance

Artificial reef must undergo some evaluation to determine the performance itself to ensure it can be applied in the real condition especially at the shallow water. The artificial reef will act as submerged with breakwater which mainly function to protect the sea beach. Some of the assessment conducted on artificial reef which are the effect of wave height and frequency behind the artificial reef. The propose of different shapes such as rectangular and circle is expected to have better performance and will suggest to use in the future after complete the assessment.

Chapter 3

METHODOLOGY

In this chapter, a new artificial reef of the breakwater have been designed to provide the concept of artificial reef. This chapter will describe the shape of the breakwater with dimension. Besides, this chapter will also deliver the introduction of the facilities and equipments used in the experiments, experimental set-up and test procedures. The shape of the new design of the breakwater will be focused on the study. The design developed by using AutoCAD software.

3.1 Breakwater Design

In this study, three propose designs of artificial reef breakwater have been developed. The differences between artificial reef breakwaters are their shapes. The first design developed to observe basic result of the experiment. The second design developed according to the basic design of artificial reef. Student proposed the last design of artificial breakwater if it will give the better performance when compared with other design in terms of wave transformation. The general dimensions of the artificial reef breakwater models are 30 cm length x 28 cm width x 7 cm height.

Table 3 : The design of breakwater constructed by using AutoCAD and has been tested in the flume.

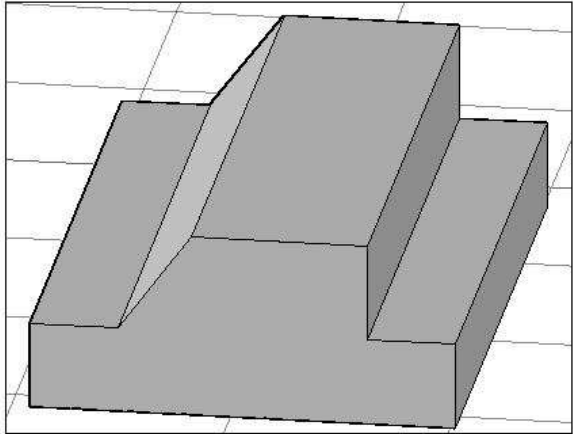
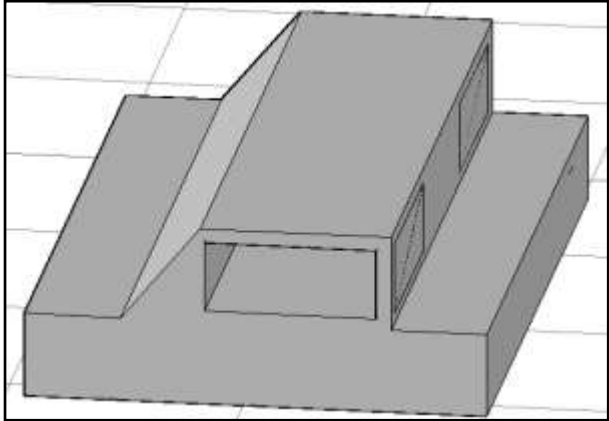
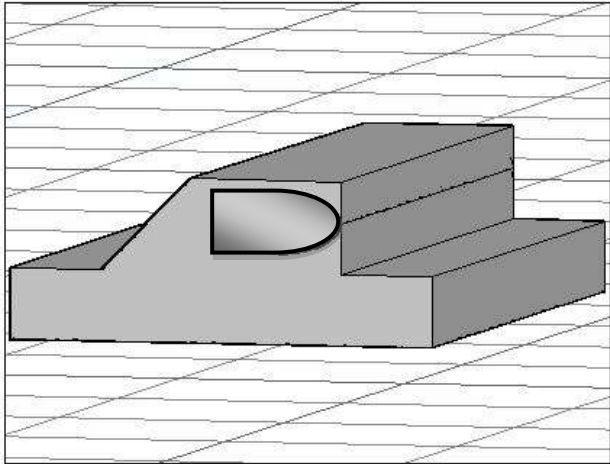
No	Design	Name of Model
1		Basic Breakwater
2		Rectangular Breakwater
3		Circle Breakwater

The artificial reef breakwaters constructed by using concrete. The concrete is chosen as the primary construction of the material because it is more stable and weight enough to provide resistance from external force impacts from water as well as not corrode easily. Table 3 illustrates the design of a breakwater constructed by using AutoCAD.

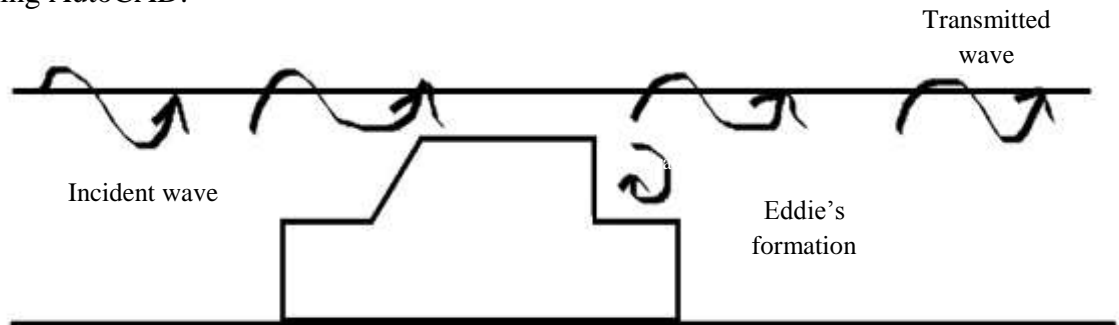





Figure 9 : Primary wave dissipation mechanism of the breakwater

Table 4 : The design of artificial reef breakwater fabricated by using concrete

No	Design	Name of model
1		Basic Breakwater
2		Rectangular Breakwater

3		Circle Breakwater
---	---	-------------------

3.2 Test Facilities and Instrumentations

The model of the artificial reef breakwater has been tested in the HM 160 Experimental Flume 86 x 300 mm at Hydraulic Laboratory at UTP. The facilities with programmable wave generator with the cross section of the experimental section are 86 x 300 mm. The flume has 15 m long, 0.5 m height and width 0.43 m. The maximum water level can fill in the wave flume at 0.47 cm. Moreover, the maximum flow rate at the range of 22.5 m³/h. The power consumption of experimental flume is 1.02 kWh. The sidewalls of the flume are made of tempered glass, which allows best observation of the experiments. Furthermore, all components that encounter water are made of corrosion-resistant materials which is stainless steel and glass reinforced concrete plastic. The inlet element is designed so that the flow enters the experiment section with very turbulence. The inclination of the experimental flume can be finely adjusted to allow simulation of slope and to create a uniform flow at constant discharge depth.

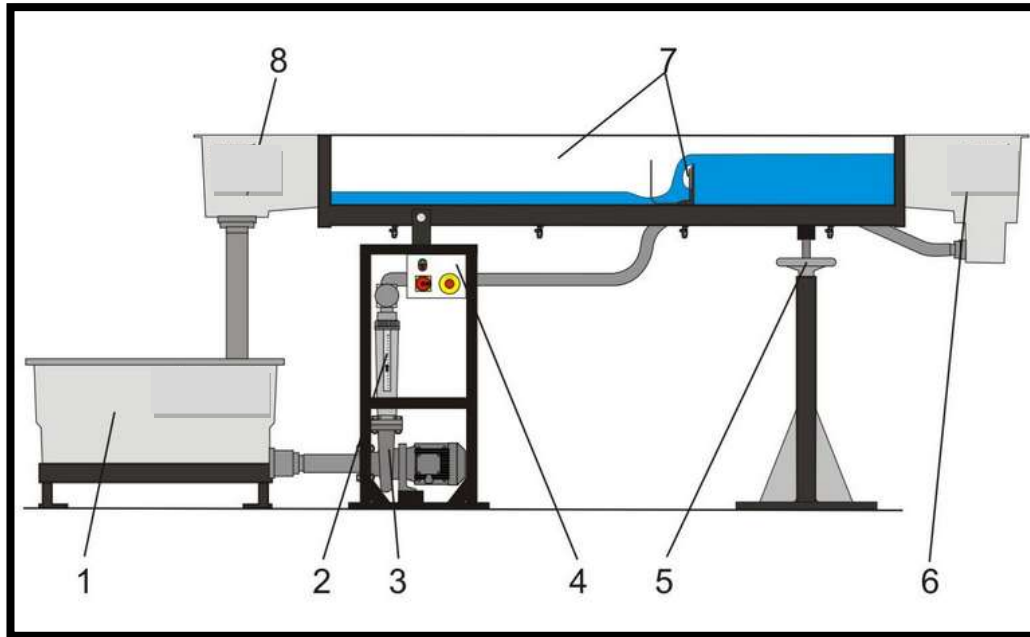

Figure 10 : HM 160 Experimental Flume 86 x 300 mm used in the experiment

Table 5 : Accessories in HM 160 Experimental Flume

Item No	Instrument Name
1	Water Tank
2	Flow Metre
3	Pump
4	Switch Box
5	Inclination Adjustment
6	Inlet Element
7	Experimental Section
8	Outlet Element

3.3 Experimental Set up

The complete experimental setup is presented in Figure 11. The purpose of physical modelling is to determine the transmission coefficient value by testing the model unit and obtain maximum wave height as well as frequency generated nearer the breakwater. The wave is produced by adjustable wave generator. The test model was put in submerged and away from wave absorber which is estimated 12 m. It is important to avoid small reflection wave from wave absorber hit back to the breakwater. It will interrupt the result of the experiment. The depth of the water is 10 cm from the bed surface of flume.

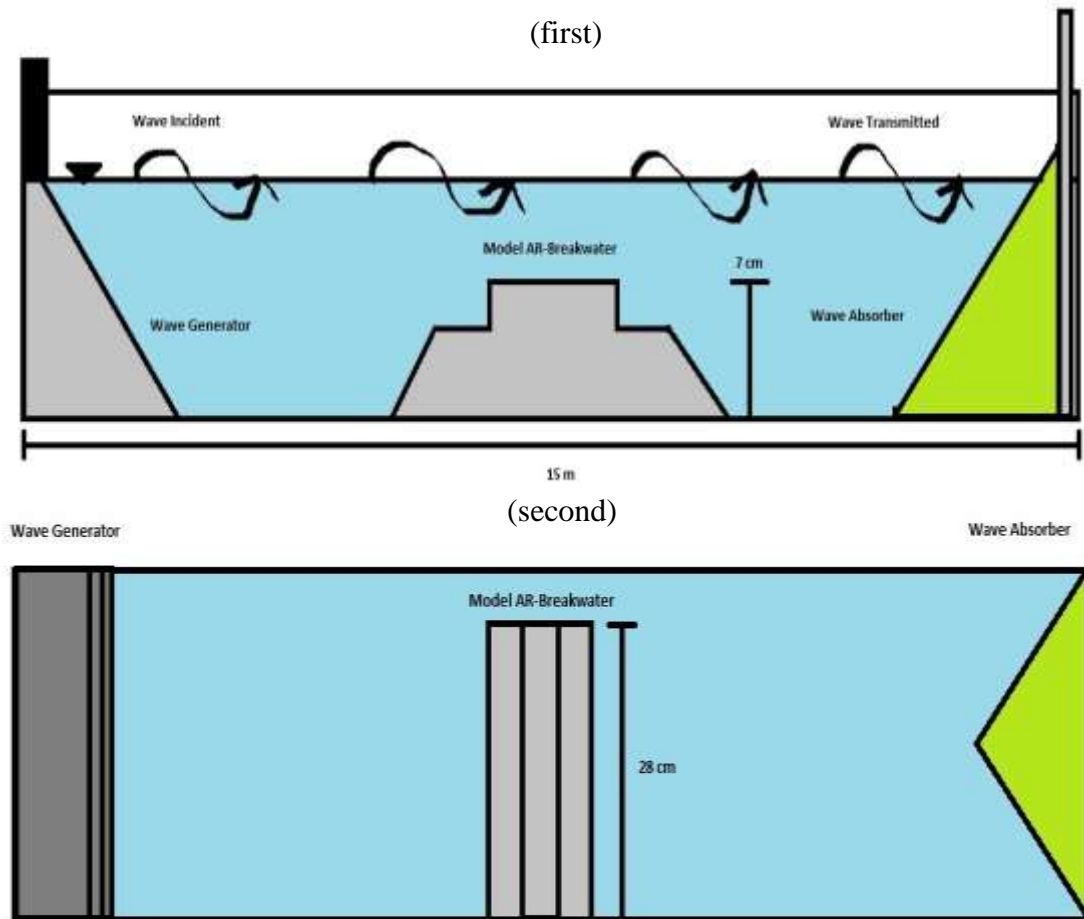

Figure 11: Side view (first) and upper view (second) of the artificial reef breakwater in the flume

The graph papers were used to measure the incident wave and transmitted wave. The maximum wave generated will be marked on the flume and measured by using a ruler.



Figure 12 : The side view of breakwater in the HM 160 flume

3.4 Test Programme

In this study, the model of breakwater will be tested by general wave condition in Malaysia. The conditions of wind wave at East of Malaysia are normally at the range of 2.5s until 4.0s for 1m [17]. The wave generated by flume is subjected regular and random wave conditions. The depth of water in the flume is 10 cm. It was used to assess the performances of breakwater in the shallow water. For shallow water, the water depth must less or equal to one-twentieth ($1/20$) of the wavelength.

All the scale has been minimize by using the ratio. It is converted according to the size of breakwater scale. The model of breakwater will be tested by the wave at the range of 0.8s to 1.10s by increase the interval of 0.10s. Generally, Malaysians sea has a less wave climate condition with peak period are in between 5s and 7s [17]. However, the experiment was used small scale according breakwater scale. In totals, approximately 21 numbers of runs were conducted in this experiment.

The parameters that need to measured are as follows:

1. The maximum height of incident wave, H_i and transmitted wave, H_t , generated to obtain coefficient of transmission wave, ct
2. The frequency, f of wave generated after hit the breakwater

3.5 Research Methodology

To achieve the objectives of the project, there are following method have been used in this study including:

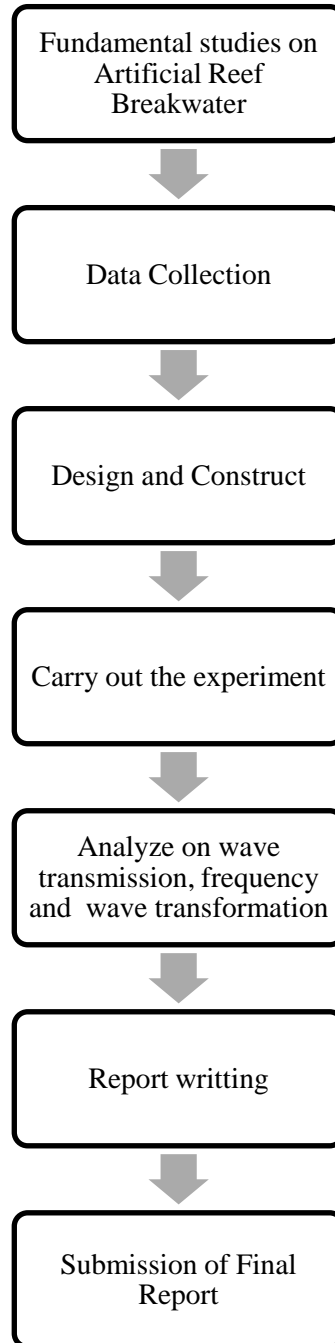

Figure 13 : Flow chart of the project while carry out the study

3.7 Key Milestone

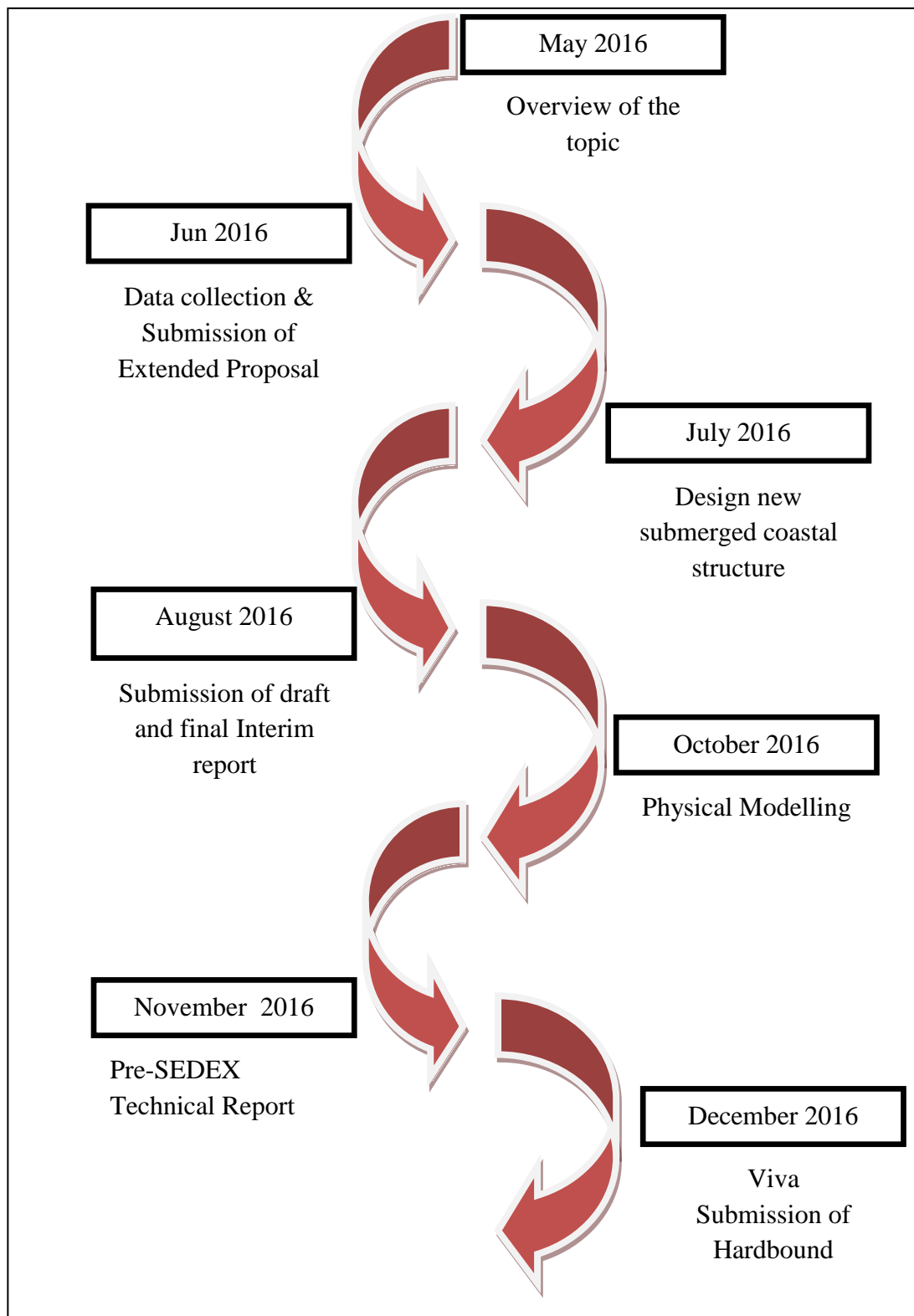

Figure 14 : Key Milestone of the project

Chapter 4

RESULT AND DISCUSSION

When waves interact with breakwaters of any shape, some of the energy was reflected to seaward of the structures and some of energy is dissipated through energy transformation by structures. In this chapter, explanation about the data collected from the experiment. This chapter will also discuss the determination of parameters required amount of hydraulic performances will be analyzed in this chapter.

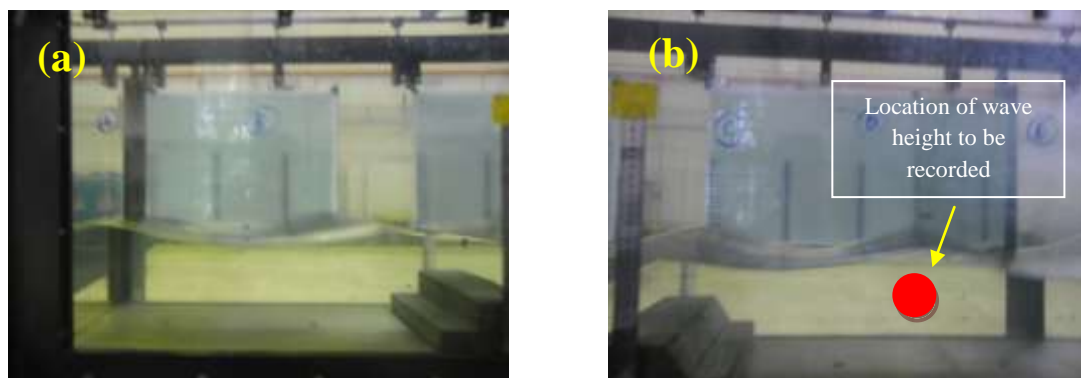

Figure 15 : (a) The set up of the test model of breakwater and (b) the location of wave height that will be measured the experiment

The location was arranged based on the distance of the probes. The spacing between locations is 15 cm. The importance to spacing between the locations is to ensure no similarity during wave height readings. The manual recording was applied in the experiment because the probes were not available during that time. The graph paper was pasted opposite with flume to ensure the maximum wave height can be observed during data collected. Therefore, manual calculation of the wave transmission had be done in this experiment.

4.1 The Effect of Wave Period on Coefficient of Wave Transmission

Wave transmission of breakwater model is quantified by the coefficient of wave transmission, t . Wave transmission characteristics of the breakwater model were investigated with respect to its wave period, T . The result coefficient of wave transmission, Ct for different models artificial reef breakwater with different wave periods, T which are ranges from 0.8s until 1.10s were tabulated in Table7.

Table 7 :Wave transmission, C_t of different model of breakwater

<i>Wave Period, T (s)</i>	<i>Frequency, f (Hz)</i>	<i>Test Model</i>	<i>Incident Wave Height H_i (cm)</i>	<i>Transmitted Wave Height, H_t (cm)</i>	<i>Coefficient of Wave Transmission, C_t</i>	<i>Frequency Transmitted, f_t (Hz)</i>	<i>Percentages Error of f_t, %</i>
0.80	2.50	Basic	1.50	0.50	0.33	1.21	3.20
		Rectangular	1.50	0.90	0.60	1.19	4.80
		Circle	1.00	0.70	0.70	1.23	1.60
0.85	2.00	Basic	1.60	0.90	0.56	1.17	0.55
		Rectangular	1.90	1.30	0.68	1.18	0
		Circle	1.50	1.00	0.67	1.16	1.69
0.90	1.67	Basic	2.10	1.60	0.76	1.10	0.90
		Rectangular	1.70	1.20	0.71	1.08	2.70
		Circle	2.30	1.40	0.61	1.09	1.80
0.95	1.05	Basic	0.60	0.70	1.17	1.00	4.76
		Rectangular	0.40	0.50	1.25	1.07	-1.90
		Circle	1.50	0.50	0.33	1.08	-2.86
1.00	1.00	Basic	1.30	1.30	1.00	1.03	-3.00
		Rectangular	1.00	0.90	0.90	1.00	0
		Circle	1.80	1.50	0.83	1.05	-5.00
1.05	0.95	Basic	1.00	0.40	0.40	0.97	-1.85
		Rectangular	0.70	0.70	1.00	0.95	0.25
		Circle	0.50	0.60	1.20	0.96	-1.26
1.10	0.91	Basic	1.00	0.70	0.70	0.96	-5.49
		Rectangular	0.80	0.70	0.88	0.93	-2.20
		Circle	0.90	1.00	1.11	0.96	-5.49

In general, Ct of respective models was having increases and decreases with the increasing of wave period, T . The artificial reef breakwater were not totally performed for the larger wave periods based on the result obtained. At 0.80s-0.90s, all the result represents the decreasing of transmitted wave height which is acceptable based on the theoretical understanding of wave transmission. It shows that the artificial reef breakwater were mainly attracting the fish. However, the wave period form 0.95s-1.10s, the results obtained did not acceptable and the Ct beyond the $Ct=1$. Circle breakwater was started decreasing in Ct until reached at the wave period 0.95s. In 2001, both of researchers Bleck and Oumeraci were mentioned that the waves behind the reef seem to be shorter and smaller than in front of the reef in the time domain [14]. Based on his statement, Circle had small values in Ct compared to Basic and Rectangular artificial reef breakwater

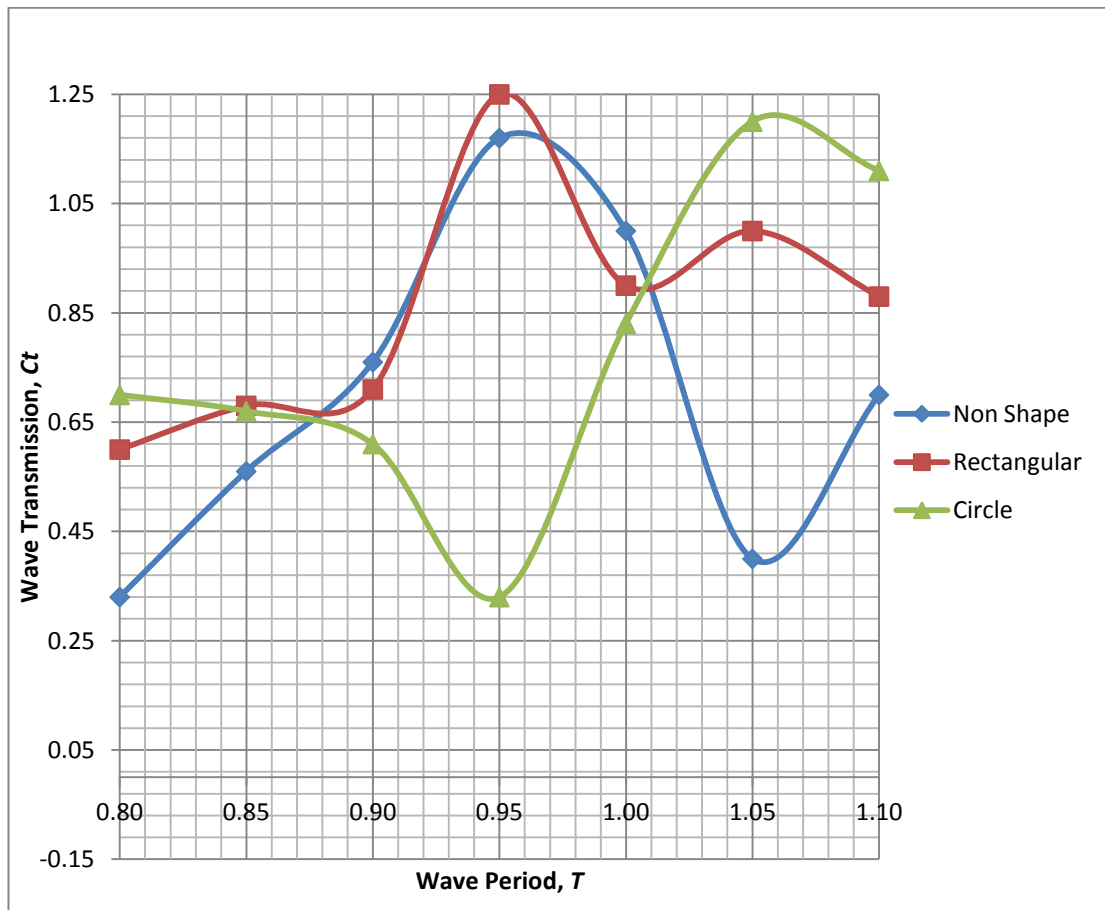

Figure 16: The graph of wave transmission, Ct between wave periods, T

4.2 Comparison Between Frequency Transmitted and Frequency Generated

Figure 17 presents the frequency transmitted from all model of breakwaters with frequency incident. The overall trend of the plot shows that frequency

transmitted of the respective models nearer with the frequency generated. Based on Table 7, the frequency transmitted record were acceptable at 0.80s to 0.90s. However, the frequency transmitted after 0.90s were not acceptable based on percentage of error calculation because the frequency transmitted is higher than frequency generated. It should be less based on experiment conducted by Armono and other researcher. They found that the incoming and transmitted wave spectrums in the vicinity of reefs was smooth and overlaid as well as obviously seen that the spectrum of incoming waves was transformed and reduced [14].

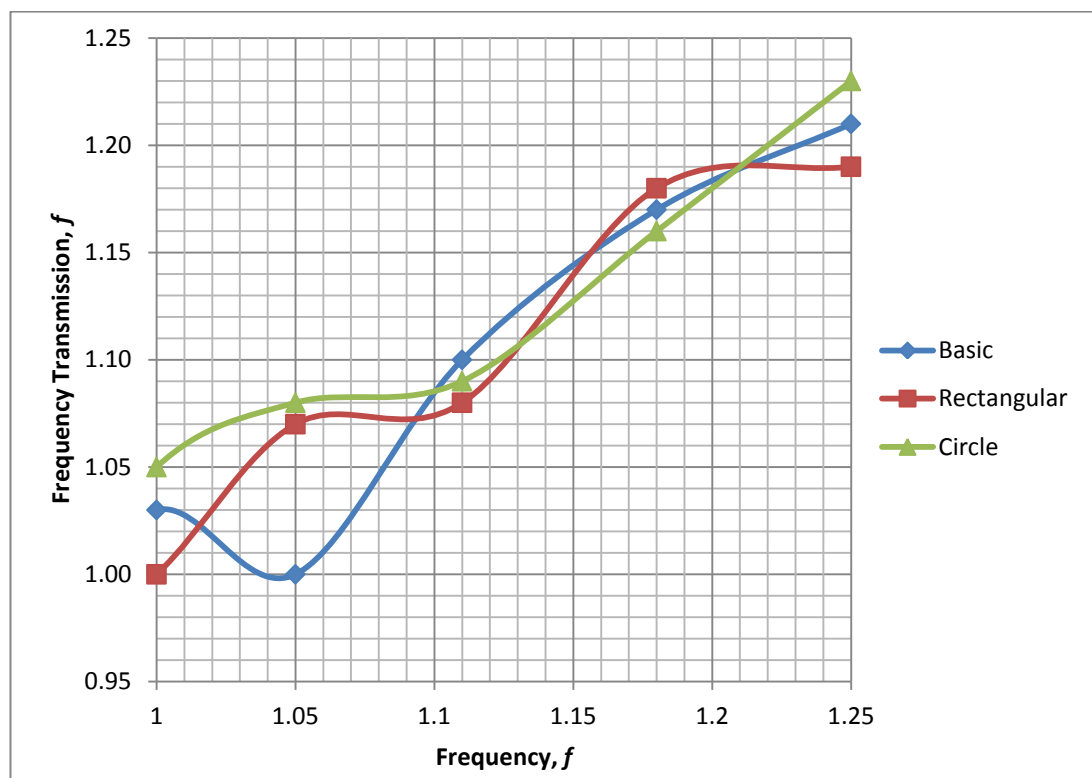

Figure 17 : The graph of frequency transmission, f and frequency incident, f

4.3 Wave Structure Interaction

The wave interactions on breakwaters were observed with the images and video record. Sample photographs were taken and shown in Figure 17, illustrate the wave structure interaction taking place at the breakwater models during the experiments. Visual observation identify that hydraulic processes that may contribute in the experiment include formation of Eddie's current, wave overtopping, and wave run up.

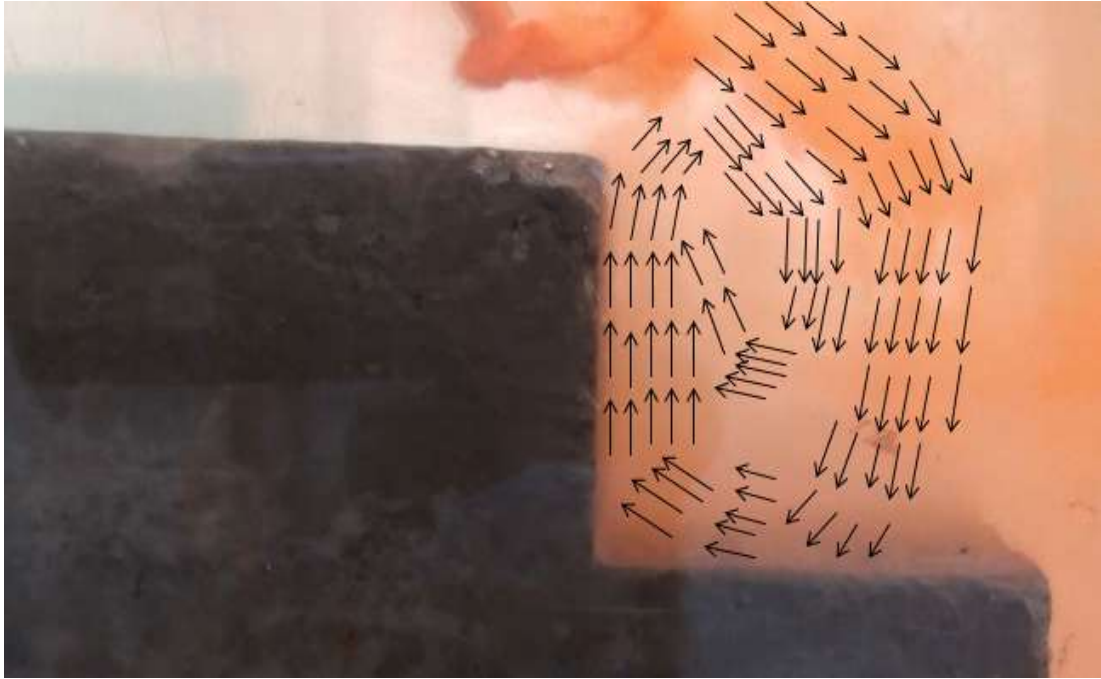

Figure 18 : Formation of Eddie on the Non Shape Breakwater at 13s



Figure 19 : Formation of Eddie on the Rectangular Breakwater at 13s



Figure 20 : Formation of Eddy on the Circle Breakwater at 13s

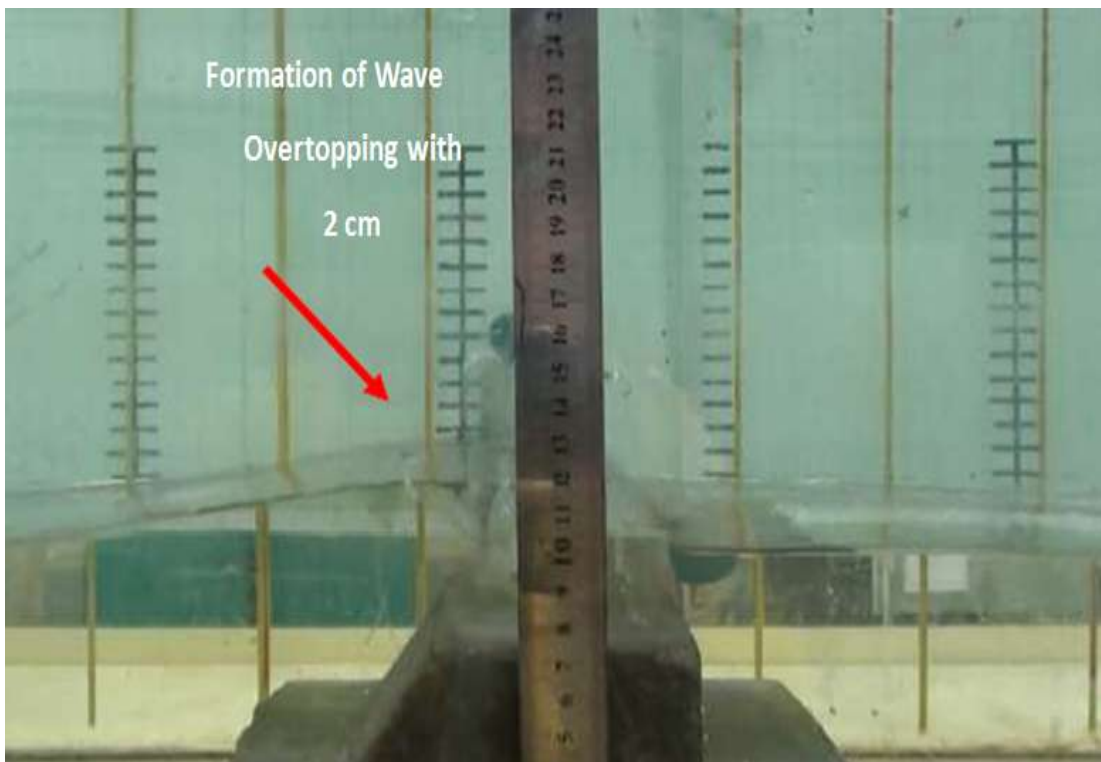

Figure 21 : Formation of wave overtopping over the breakwater

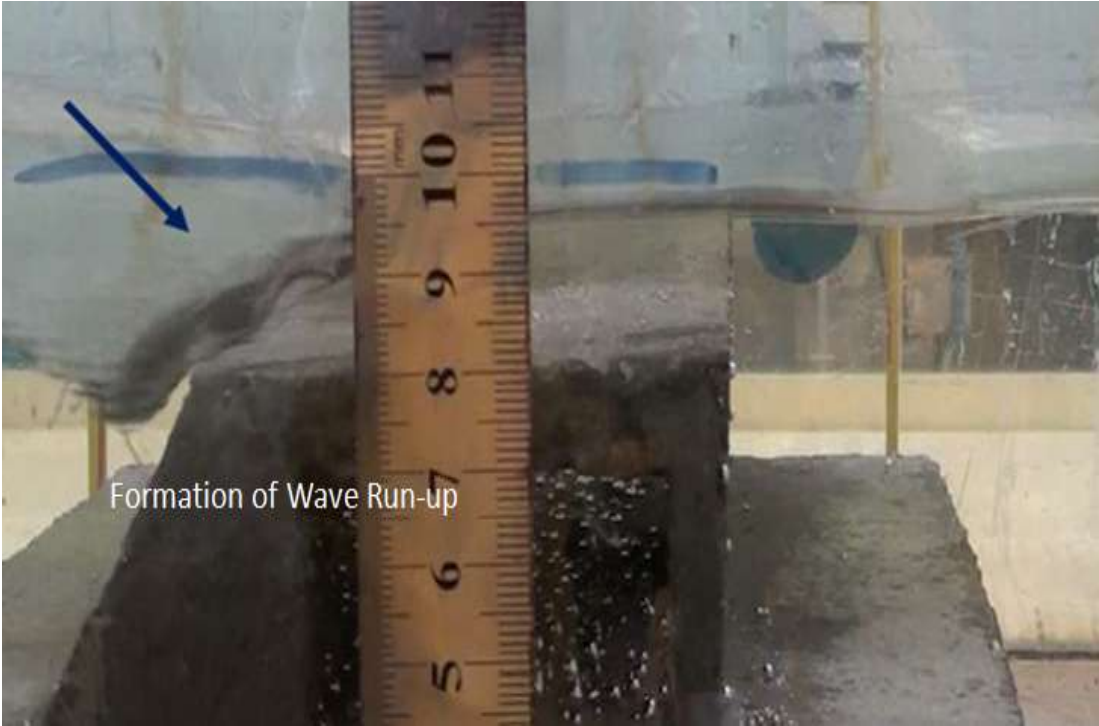

Figure 22 : Wave run up at the front of breakwater

Chapter 5

CONCLUSION AND RECOMMENDATION

The new breakwater similarly to artificial reef function has been designed and tested. The wave hydrodynamics interaction to the new designed breakwater has been successfully investigated and analyzed. The different shape of breakwaters affect the wave transmission after hit the breakwater. From 0.80s-0.90s, the result represents the acceptable wave transmission coefficient values. It shows that the artificial reef breakwater mainly attracting the fish. However, from 0.9s-1.1s the results illustrate uncertainty values. Circle breakwater generates lowest wave transmitted frequency, ft compared to other breakwater models. Ini addition, Circle breakwater gives better performance compared to other breakwater models in term of wave transmitted frequency, ft. Further research especially conducting more tests and design shapes for better understanding and performances. The researcher can ensure that the equipment such as wave probes must available and function during the lab test. This new invention will definitely benefit toward human need, environment and aquatic life. The outcome of the research will be useful for submerged coastal structure at Malaysian sea.

REFERENCES

- [1] N. D. M. Noor and A. M. Hashim, "Performance Evaluation of Innovative Concrete Armor Unit for Coastal Protection Structure," 2013.
- [2] M. Asmawi and A. N. Ibrahim, "The Perception of Community on Coastal Erosion Issue in Selangor Malaysia," *Journal of Clean Energy Technologies*, vol. 1, pp. 164-168, July 2013.
- [3] D. Y. Nordin, "Towards Sustainable Coastal Planning And Policies From A Malaysian Perspective," *WIT Transactions on Ecology and the Environment*, vol. 88, 2006.
- [4] N. Nasuchon, "Coastal Management And Community Management In Malaysia, Vietnam, Cambodia, And Thailand with A Case Study of Thai Fisheries Management," Division For Ocean Affairs And The Law of The Sea, New York, 2009.
- [5] DID Manual - Coastal Management, Kuala Lumpur: Government of Malaysia Department of Irrigation And Drainage, 2008.
- [6] A. B. John, A. F. David, C. Georgenes, G. B. Andrew and U. Paolo, "Urbans Breakwaters as Reef Fish Habitat In The Persian Gulf," *Marine Pollution Bulletin*, vol. 72, pp. 342-350, 2013.
- [7] H. D. Armono, "A Two Dimensional Hydrodyanamics Model In The Vicinity Of Artificial Reef," in *PIT XXI-HATHI*, Denpasar, 2004.
- [8] F. Bulleri and M. Chapman, "The Introduction of Coastal Infrastructure As A Driver of Change In Marine Environments," *Journal of Applied Ecology*, vol. 47, pp. 26-35, 2010.
- [9] "Information About Sea Turtles: Threats From Coastal Armoring," Sea Turtle Conservacy, 2015. [Online]. Available: <http://www.conserveturtles.org/seaturtleinformation.php?page=seawalls>. [Accessed August 2016].
- [10] R. Shepman and R. Spieler, "Tires: Unstable Materials For Artificial Reef Construction," *Oceangraphy Faculty Proceedings*, p. 58, 2006.
- [11] M. Fousert, "Floating Breakwater:Theoretical Study of A Dynamic Wave Attenuating System," Delft University of Technology, Netherland, 2006.

- [12] A. S. Ahmadian and R. Simons, "3-D Wave Field Around Submerged Breakwater," Civil, Environmental and Geomatic Engineering Department, UK, 2012.
- [13] M. Baine, "Artificial reefs : A review of their design, application, management and performance," *Ocean & Coastal Management*, vol. 44, pp. 241-259, 2001.
- [14] H. D.Armono, A. Kurniawan, R. Akhwady and S. , "Wave Spectrum Change In The Vicinity of Artificial Reef," *Journal of Indonesia Coral Reefs*, vol. 2, no. 1, pp. 75-84, 2011.
- [15] H. D. Armono, "Flow Field Around Single And Multiple Hollow Hemispherical Artificial Reefs Used For Fish Habitat," Faculty of Engineering And Applied Science, Newfoundland, 1999.
- [16] A. Spagnolo, G. Scarcella and E. Charbonnel, "Practical Guidelines For The Use Of Artificial Reefs In The Mediterranean And The Black Sea," General Fisheries Commissions, Mediterranean, January 2015.
- [17] C. E.P., P. Aswatha Narayana and Z. Z.A., "Wave Power Potential Around East Malaysia," School of Mechanical Engineering, Nibong Tebal, Pulau Pinang, 2001.
- [18] O. Yaakob, F. E. Hashim, K. Mohd Omar, A. H. Md Din and K. King Koh, "Satellite-based Wave Data And Wave Energy Resource Assessment For South China Sea," *Renewable Energy*, vol. 88, pp. 359-371, 2016.