

**SPRAY CHARACTERISTIC OF GASOHOL BLENDS USING  
OPTICAL MEASUREMENT**

By

**ABDUL HAFIZ BIN ABD MAJID**

**12309**

Dissertation submitted in partial fulfillment of

The requirements for the

Bachelor of Engineering (Hons)

(Mechanical Engineering)

SEPT 2011

Universiti Teknologi Petronas

Bandar Seri Iskandar

31750 Tronoh

Perak Darul Ridzuan

## **ABSTRACT**

This research is about to characterize the spray of gasoline-ethanol (gasohol) blends using optical measurement. The Image of the spray is captured using optical measurement to extract spray characteristics- spray tip penetration and spray cone angle. The focus of this study was to investigate the spray characteristics performance of gasoline fuel (E0) and gasoline-ethanol (gasohol) fuel (E10) in a direct injection gasoline injector in a gasoline engine. Two different fuel which is gasoline fuel (E0) and gasoline-ethanol (gasohol) fuel (E10) blend rates by volume are prepared. The Image of the spray is captured using imaging technique and image processing is employed to extract spray characteristics of gasohol blends which is spray tip penetration and spray cone angle. The experimental result is compared to the theoretical result to see the actual result is similar to the theoretical or not. Digital camera was used in order to observe the structure of fluids and to measure the spray angles at nozzle exit. Based on the extracted tip penetration and cone angles Gasoline (E0) shows that longer penetration, ethanol show the lower penetration and E10 is more closed to gasoline characteristic, it is because fraction of E10 is more to gasoline (E0) other than ethanol. So that the higher ethanol fraction in gasoline blends produce lower spray tip penetration and larger cone angle.

CERTIFICATION OF APPROVAL

Spray Characteristic of Gasohol Blends Using Optical Measurement

By

Abdul Hafiz Bin Abd Majid

A project dissertation submitted to the

Mechanical Engineering Programme

Universiti Teknologi PETRONAS

In partial fulfillment of the requirement for the

BACHELOR OF ENGINEERING (Hons)

(MECHANICAL ENGINEERING)

Approve by :

---

(Mohd Faizairi Bin Mohd Nor)

UNIVERSITI TEKNOLOGI PETRONAS

TRONOH, PERAK

Sept 2011

## CERTIFICATION OF ORIGINALITY

This is to certify that I am responsible for the work submitted in this project, that the original work is my own except as specified in the references and acknowledgements, and that the original work contained herein have not been undertaken or done by unspecified sources or persons.

---

ABDUL HAFIZ BIN ABD MAJID

## TABLE OF CONTENT

	<b>Page</b>
<b>ABSTRACT</b>	<b>i</b>
<b>CHAPTER 1: INTRODUCTION</b>	<b>1</b>
1.1 Background Study	1
1.2 Problem Statement	2
1.3 Objective of Study	2
1.4 Scope of Work	2
<b>CHAPTER 2: LITERATURE REVIEW</b>	<b>3</b>
2.1 Introduction	3
2.2 Alternative Fuel	3
2.2.1 Alcohol	5
2.2.2 Ethanol	5
2.2.3 Gasohol	7
2.3 Fuel Injection	7
2.4 Optical Study	9
2.4.1 High Speed Camera	9
2.5 Spray Characteristic	9
2.6 Previous Study on Experimental of Fuel Spray	11
2.6.1 Atomization and Spray Characteristic of Bio-ethanol Blended Gasoline (E85) and (E100)	12
2.6.1.1 Experimental Setup	12
2.6.1.2 Numerical Analysis	14
2.6.1.3 Result	15
2.6.2 Gasoline-Ethanol (Gasohol) Fuel Blend Spray Characterization using Digital Imaging and Image Processing	16
2.6.2.1 Experimental Setup	16
2.6.2.2 Result	17

<b>CHAPTER 3: METHODOLOGY</b>	<b>19</b>
3.1 Introduction	19
3.2 Research Flow Chart	19
3.3 Test Rig Development	21
3.4 Experimental Setup	22
3.5 Experimental Equipment	23
3.5.1 Fuel Tank	23
3.5.2 Fuel Filter	24
3.5.3 High Pressure Fuel Pump	24
3.5.4 Fuel Pressure Regulator	25
3.5.5 High Pressure Chamber	25
3.5.6 DC Power Supply	25
3.5.7 Fuel Injector	26
3.5.8 Digital Camera	26
<b>CHAPTER 4: RESULT AND DISCUSSION</b>	<b>27</b>
4.1 Introduction	27
4.2 Experimental Spray Pattern	27
4.2.1 Spray Pattern According to Time Frame	29
4.3 Spray Tip Penetration versus Time	30
4.4 Spray Cone Angle versus Time	31
4.5 Theoretical Calculation	32
4.5.1 Flow Rate	32
4.5.2 Spray Characteristics	32
<b>CHAPTER 5: CONCLUSION AND RECOMMENDATION</b>	<b>35</b>
5.1 Introduction	35
5.2 Conclusion	35
5.3 Recommendation	36
<b>REFERENCES</b>	<b>37</b>
<b>APPENDICES</b>	<b>39</b>

<b>LIST OF FIGURES</b>	<b>PAGE</b>
Figure 2.1: Fuel property of Ethanol and Gasoline	6
Figure 2.2: Fuel Injector	8
Figure 2.3: Definition of spray characteristic (sprays tip penetration, spray width and spray angle).	10
Figure 2.4: Schematic of experimental setup	13
Figure 2.5: Specification of the droplet analysis system and high speed camera.	13
Figure 2.6: Experimental conditions	13
Figure 2.7: Measuring points for analysis of fuel droplet and the calculation meshes in KIVA code	14
Figure 2.8: A side and bottom view at condition of injector pressure was 4.0 MPa	15
Figure 2.9: A side and bottom view at condition of injector pressure was 8.0MPa	15
Figure 2.10: Spray tip Penetration of different ethanol gasoline blends	17
Figure 2.11: Spray cone angle for different gasohol blends.	18
Figure 3.1: Project flow chart.	20
Figure 3.2: Test rig design	21
Figure 3.3: Schematic diagram for current experimental setup	22
Figure 3.4: Actual experimental setup	23
Figure 3.5: Fuel Tank	24
Figure 3.6: High Pressure Chamber.	25
Figure 3.7: Fuel Injector assembly	26
Figure 4.1: Injector spray pattern for E0	28
Figure 4.2: Injector spray pattern E10	28
Figure 4.3: E0 during 10ms until 40ms	29
Figure 4.4: E10 during 10ms until 40 ms	30
Figure 4.5: Graph spray penetration versus time after start injection for three different fuels	30
Figure 4.6: Graph spray penetration versus time after start injection for three different fuels from 8 ms to 10 ms	31
Figure 4.7: Graph spray cone angle versus time after start injection for three different fuels	31

**LIST OF TABLES****PAGE**

Table 2.1: Fuel characteristics	4
Table 4.1: Volumetric flow rate measuring	30
Table 4.2: Fuel Properties	31
Table 4.3: Spray tip penetration	32
Table 4.4: Spray cone angle.	33



# CHAPTER 1

## INTRODUCTION

### 1.1 BACKGROUND STUDY

Gasoline-ethanol blends (Gasohol) gain importance within these recent years as alternative fuel due to its high octane number, especially with ethanol which has low carbon with comparison to gasoline. This led the gasohol (a mixture of 10% alcohol with 90% gasoline) to be a commercial fuel in over 35 countries of the World including the USA, Canada and France. (T. Lee, 1995). It is also well-known that the future availability of energy resources as well as the need to reduced carbon dioxide emissions and pollutants promotes an increased utilization of regenerative fuels. Alcohols, such as ethanol which is a colourless liquid with mild characteristic odour and can be produced from coal, natural gas and biomass, have high octane rating and can be used as one of the realistic alternative fuels. Moreover, ethanol has higher heat of vaporization compared to gasoline which means that freezes the air allowing more mass to be drawn into the cylinder and increases the power output. Besides that, ethanol has anti-knock properties that improves engine efficiency and gives higher compression ratios (Owen Keith, 1995).

Ethanol-gasoline blends as a fuel is an alternative strategy for replacing hydrocarbon fuels for renewable energy source. Previous researchers studied spray properties of different blends of ethanol-gasoline (25%, 50%, 75% and 100% ethanol) under ambient conditions by means of high speed schlieren photography technique. Other than that, researchers studied about to evaluate the enthalpy of vaporization of ethanol-gasoline mixtures by using vapour pressure measurements, optical sensor for concentration ratio monitoring of ethanol from their mixture in gasoline on the basis spectrum analysis for various sample compositions (optic Raman sensor) and sensor embedded in ethanol and regular gasoline for determining mass ratio.

## **1.2 PROBLEM STATEMENT**

Today's, fuel's price in the market is increasing. To overcome this problem, in the overseas development of alternative fuel and use of alternative fuel become broad, but in Malaysia this area is still limited. There are many example of alternative fuel used in car such as acetone, methanol, and ethanol. This research focusing on ethanol gasoline blends or commonly known as gasohol. The investigation of spray characteristics of 10% gasohol fuel blends as well as pure gasoline using optical measurement and comparing these two different fuels according to time frame. These data and results are compared to each other.

## **1.3 OBJECTIVES OF STUDY**

The main objectives of the study are to investigate the spray characteristics of gasohol fuel blends using optical measurement.

## **1.4 SCOPE OF WORK**

There are four scopes in this study:

- a. Choosing 1.0 mm fuel injector and available optical measurement.
- b. Setup test rig for experimental usage of high pressure chamber.
- c. Choosing fuel blends E0 and E10 as a sample to doing experimental using ambient temperature of 300K
- d. Compare the spray characteristics that focus only on spray angle and spray tip penetration within theory and actual experiment.

## **CHAPTER 2**

### **LITERATURE REVIEW**

#### **2.1 INTRODUCTION**

This chapter concludes about why development of alternative fuel, alcohol and ethanol characteristics, fuel injection system and type of injector, high speed camera, microscopic spray characteristics and previous study of fuel blends. Purpose of literature review is as guide on how to conduct experiment and selection of equipment used.

#### **2.2 ALTERNATIVE FUEL**

During 21<sup>st</sup> century, petroleum products become costly to find and produce. Meanwhile, the number of automobiles and other internal combustion engine increase rapidly. Although fuel economy of engines is greatly improve from the past, numbers of demand for fuel is still high. There are some engines fuelled with non-gasoline or diesel fuel but their numbers have been relatively small. To overcome this problem, some countries have been using manufactured alcohol as their main vehicle fuel. Another reason motivating the development of alternative fuel for internal combustion engine is concern about emission problems of gasoline and diesel engines. Combined with other air polluting systems, the large number of automobile is a major contributor to the air quality problem of the world. Furthermore, Malaysia still imported crude oil from other countries which control the larger oil fields. Most of alternative fuels are very costly at present. This is often because of quantity of used. However when usage is broad, cost of manufacturing, distribution and marketing should be less. (Pulkrabek, W. W., 2004).

However, a different fuel comes with different characteristics. Table 2.1 is listed the fuel characteristics for common known type of fuels for specific gravity, RON, MON, fuel air ratio, heat energy, latent heat of evaporation and weight.

<b>Fuel</b>	<b>Specific gravity</b>	<b>RON</b>	<b>MON</b>	<b>Fuel/air ratio (lb/lb)</b>	<b>Heat Energy (Btu/lb)</b>	<b>Latent heat of evaporation</b>	<b>Weight (lb/gal)</b>
Acetone	0.79			1:10.5	12500	225	8
Benzol	0.88	105-110	95-100	1:11.5	17300	169	8.7
Ethanol	0.79	108-115	90-92	1:6.5	12500	410	8
Ether	0.71				15000	153	7
Methanol	0.79	105-115	89-91	1:4.5	9800	472	8
Nitromethane	1.13			1:2	5000	258	11.3
Petrol unleaded	0.74	97	85-86	1:12	19000	135	7.4
Petrol leaded	0.73	96	86	1:12.5	19000	135	7.3
Racing unleaded	0.75	104-106	94-96	1:13.2			7.5
Racing leaded	0.73	112-114	102-104	1:12.7			7.3

**Table 2.1:** Fuel characteristics.

Source: Bell (1998)

### 2.2.1 Alcohol

Alcohol is an attractive alternative fuel because they can be obtained from a number of sources; both natural and manufactured. Methanol (methyl alcohol) and ethanol (ethyl alcohol) are two kinds of alcohol that seem most promising and have had the most development as engine fuel.

The advantages of alcohol as a fuel include:

- a) Absorb moisture in the fuel tank.
- b) Ten percent alcohol added to gasoline raises the octane rating, using the  $(R+M)/2$  method, by nearly three points.
- c) Alcohol cleans the fuel system.
- d) The addition of alcohol reduces CO emissions.

The disadvantages of alcohol as a fuel include:

- a) The use of alcohol blends can result in the clogging of fuel filters.
- b) Alcohol not vaporizes easily at low temperature.
- c) Alcohol raises the volatility of fuel about 0.5 psi (3.5kPa), resulting in possible hot weather drivability problems.
- d) Alcohol absorbs water and then separates from the gasoline, especially as the temperature drops.

### 2.2.2 Ethanol

Ethanol is also known as ethyl alcohol or grain alcohol. Ethyl ethanol is an alcohol made from grain. Ethanol was first used to extend gasoline supplies during the gasoline shortage of the 1970s. Ethanol has an oxygen content of approximately 35 percent, thus a 10 percent concentration adds about 3.5 percent oxygen to mixture. Like gasoline, ethanol contains hydrogen and carbon, but ethanol also contains oxygen in its chemical structure. The addition of oxygen makes for a cleaner burning fuel than gasoline. Another benefit of ethanol is that it increases the

octane rating of fuel. A 10 percent ethanol mixture will raised an 87 octane fuel by at least 2.5 octane numbers. However, the alcohol added to the base gasoline also raised volatility of the fuel about 0.5 psi or 3.5 kPa. Most automobile manufacturers permit up to 10 percent ethanol if drivability problems are not experienced. According to Yuksel et al. (2003) in his journal title the use of ethanol-gasoline blends as a fuel in an SI engines, characteristics of ethanol and gasoline is distinguish by viewpoint of formula, molecular weight, density, specific gravity and so on.

Fuel property	Ethanol	Gasoline
Formula	C <sub>2</sub> H <sub>5</sub> OH	C <sub>4</sub> to C <sub>12</sub>
Molecular weight	46.07	100–105
Density, kg/l, 15/15 °C	0.79	0.69–0.79
Specific gravity (Relative density), 15/15 °C	106–110	91
Freezing point, °C	–114	–40
Boiling point, °C	78	27–225
Vapor pressure, kPa at 38 °C	15.9	48–103
Specific heat, kJ/kg K	2.4	2.0
Viscosity, mPa s at 20 °C	1.19	0.37–0.44
Lower heating value, 1000 kJ/L	21.1	30–33
Flash point, °C	13	–43
Auto-ignition temperature, °C	423	257
Flammability limits, Vol %		
Lower	4.3	1.4
Higher	19.0	7.6
Stoichiometric air–fuel ratio, weight	9.0	14.7
Octane number		
Research	108.6	88–100
Motor	89.7	80–90

**Figure 2.1:** Fuel property of Ethanol and Gasoline.

Source: Yuksel et al. (2003)

### **2.2.3 Gasohol**

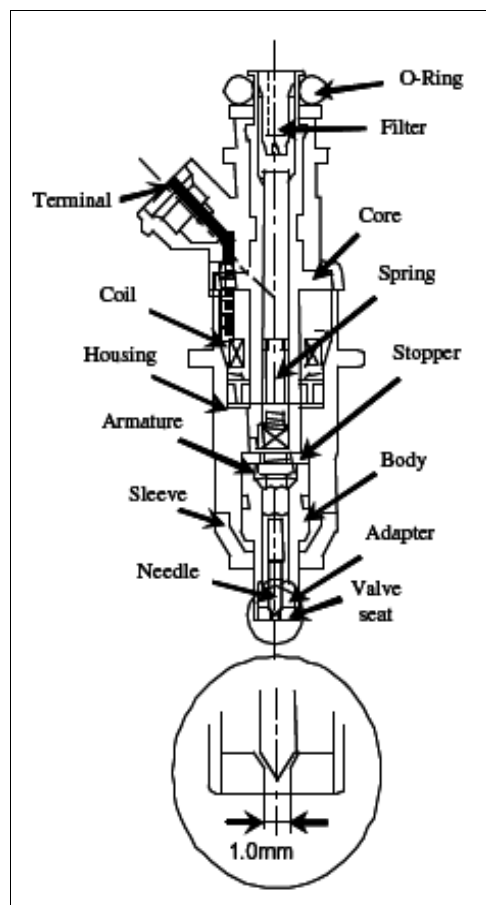
Gasohol is a mixture combination between gasoline and ethanol. It is introduced in the 1990s and is mostly used in Brazil. It is usually a mixture of 10 percent ethyl alcohol and 90 percent unleaded gasoline. Ethyl alcohol is made from sugar, grain or other organic living material. It is believed that the use of gasohol eases the demand for crude oil. Gasohol reduces the use of gasoline with no modification needed to an automobile engine. (Hollembek, B., 2006) says that gasoline blended with 10 percent alcohol or less does not require changes to the fuel system. However, vehicles burning any amount of gasohol may require that the fuel filter be changed more often. This is due to the cleaning effect that alcohol has on the vehicle's fuel tank. Oxygenated suspended water in fuel tends to keep it from accumulating in the gas tank. One gallon of gasoline can hold only 0.5 teaspoon of water. As a result, the water separates and accumulates at the bottom of the tank.

## **2.3 FUEL INJECTION**

Fuel injection is a system for mixing two substances which are fuel and air in an internal combustion engine. It has become the primary fuel delivery system used in automotive petrol engines, having almost completely replaced carburetors in the late 1980s. A fuel injection system is designed and calibrated specifically for the type of fuel it handles. The main difference between a carburetor system and a fuel injection system is that fuel injection atomizes the fuel by forcibly pumping it through a small nozzle under high pressure, while a carburetor relies on low pressure created by intake air rushing through it to add the fuel to the airstream.

Fuel injectors are nozzles that inject a spray of fuel into the intake air. They are normally controlled electronically for modern engines. A metered amount of fuel is trapped in the nozzle end of the injector and a high voltage is applied to it. At proper time, the nozzle is opened and fuel is sprayed into the surrounding air. The amount of fuel injected each cycle is controlled by injector pressure and time duration of injection. An electronic fuel injector consists of the following basic components: valve

housing, magnetic plunger, solenoid coil, helical spring, fuel manifold and needle valve. When activated, the electric solenoid coil is excited which move plunger and connected needle valve. This opens the needle valve and allows fluid from the manifold to be injected out the valve orifice. The valve can either be pushed opened by added pressure from the plunger or it can be opened by being connected to plunger, which then releases the pressurized fuel. Each valve can have one or several orifice openings, each having diameter of about 0.2 to 1.0 mm. The fuel exits the injector at velocities greater than 100 m/s and flow rates of 3 to 4gm/sec.



**Figure 2.2:** Fuel Injector.

Source: Lee, et al. (2009)



## **2.4 OPTICAL STUDY**

Mostly of previous researcher is using high speed camera in order to study microscopic spray characteristics of fuel spray according to time frame.

### **2.4.1 High speed camera**

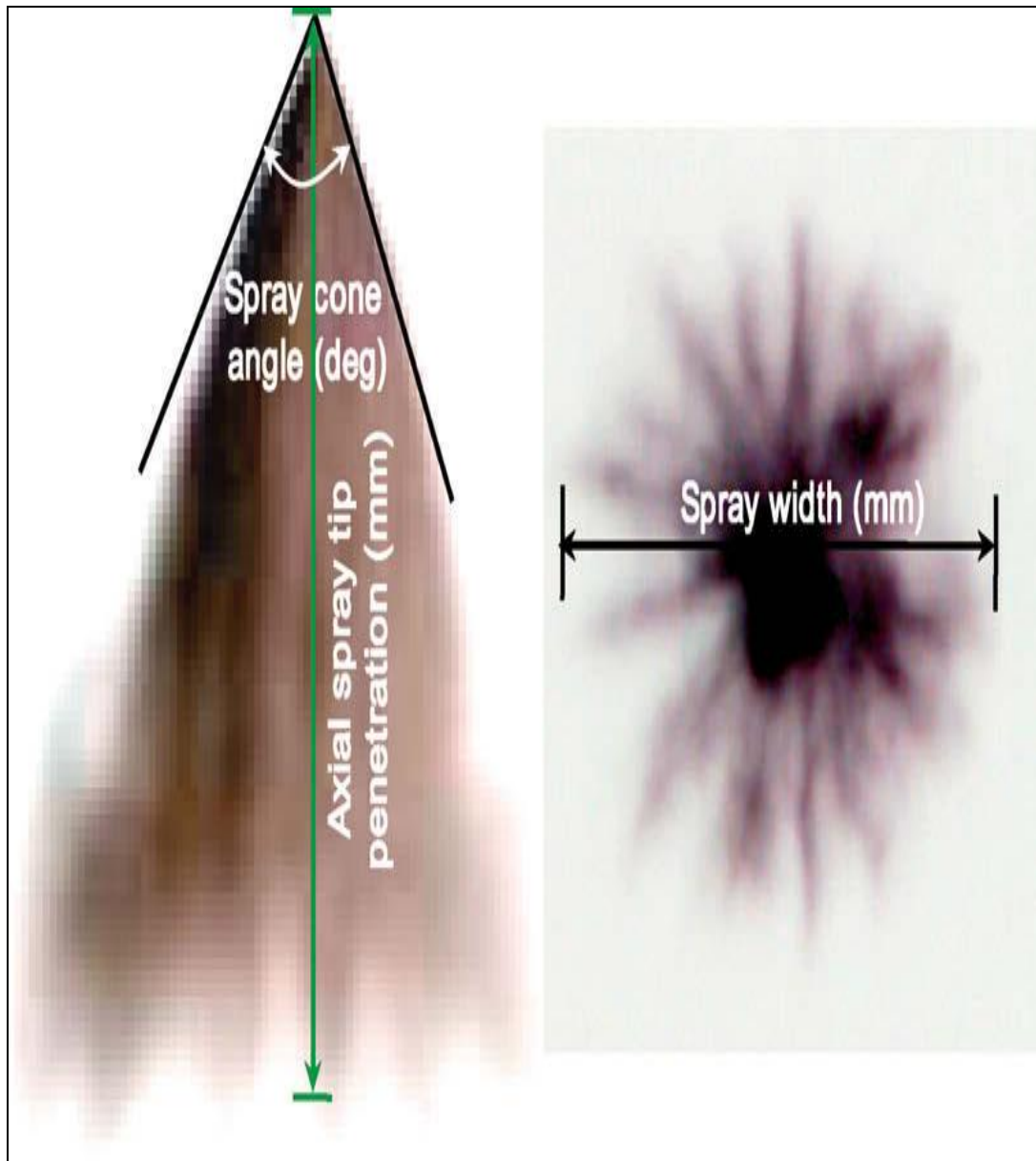
In order to study about microscopic spray characteristics of fuel spray in time frame, it is require a high speed camera. An example of high speed camera that mostly use is Photron, Fastcam-APX RS. This camera provides full mega pixel resolution images at frame rates up to 3,000 frames per second (fps), 512 x 512-pixels resolution at 10,000fps and at reduced frame rates to an unrivalled frame rate of 250,000fps.

Utilizing Photron's advanced sensor technology; the APX-RS provides the higher light sensitivity than any other comparable high-speed imaging system. A user selectable 'Region of Interest' function enables the active image area to be defined in steps of 128 pixels wide by 16 pixels high to allow the most efficient use of frame rate, image resolution and memory capacity for any event. Up to 20 commonly used configurations can be saved to memory for future operation. Available with Gigabit Ethernet, FireWire and fibre optic communications, this compact camera can provide exposure durations as short as 2 microseconds and is easily operated in the field with or without a computer through use of the supplied remote keypad; enabling full camera setup, operation and image replay.

## **2.5 SPRAY CHARACTERISTICS**

The microscopic spray characteristic including axial spray tip penetration, spray width and spray angle are shown in figure 2.3. The spray tip penetration and spray width were defined as maximum distance from the nozzle tip of the side view spray image and maximum radial distance from the bottom view, respectively. Also

the spray cone angle is defined as the interval which is formed by the nozzle tip and two straight lines wrapped with the maximum outer side of the spray. Amirruddin, et al. (2009) says that when the ethanol percentage is higher the spray spread faster, produce longer penetration distance.



**Figure 2.3:** Definition of spray characteristic (sprays tip penetration, spray width and spray angle).

Source: Lee, et al. (2009)

## 2.6 PREVIOUS STUDY ON EXPERIMENTAL OF FUEL SPRAY

There are many researcher studied about ethanol blends such as Lee et al. (2001a) studied the spray structure characteristics of a high pressure gasoline injector. They revealed that the GDI injector produced a hollow-cone spray due to the centrifugal force resulting from the angular momentum generated at tangential ports in the nozzle. In addition, they reported that the upward spray vortex contributed to a uniform distribution of fuel droplets.

Wang et al. (2005) reported that the GDI spray can be divided into an initial spray stage (initial spray slug) and a main spray stage. In their paper, the initial spray slug generated due to low overall injection and tangential speeds is the remnant fuel of the early injection cycle in the slots between the needle and the tangential gap. The main spray has a hollow cone structure with a distinct swirl structure occurring on both sides of the spray, leading to strong air entrainment and fuel air mixing. Kawahara et al. (2004) observed and analyzed the fuel spray behaviour near the nozzle tip of a GDI injector. They revealed that the liquid film sheet has a ligament structure and a higher injection pressure causes reduced thickness and a shorter length of the liquid sheet. In addition to these mentioned studies, many researches regarding GDI engines have performed (Lee et al., 2001b; Powell and Lee, 2007). In particular, spray-guided GDI engines are currently being actively investigated (Chang et al., 2007; Kim et al., 2008). Gao et al. (2007) studied the spray characteristics using ethanol–gasoline blended fuels. They reported that the main spray tip penetration decreases and the spray cone angle increases with the increase of the ethanol fraction in the low ambient pressure. However, in the case of the elevated ambient pressure conditions, the difference of spray penetration among the blends shows inconspicuous, while the spray cone angle of all test fuels keeps almost constant in the fully developed stage except that the spray of pure gasoline shows a larger spray cone angle in the beginning of injection period. Lee et al. (2009) studied the macroscopic and microscopic atomization characteristics of bio-ethanol and bio-ethanol blended gasoline fuel by investigating the spray evolution process, overall spray characteristics, and mean droplet size in a direct injection gasoline injector of a gasoline engine.

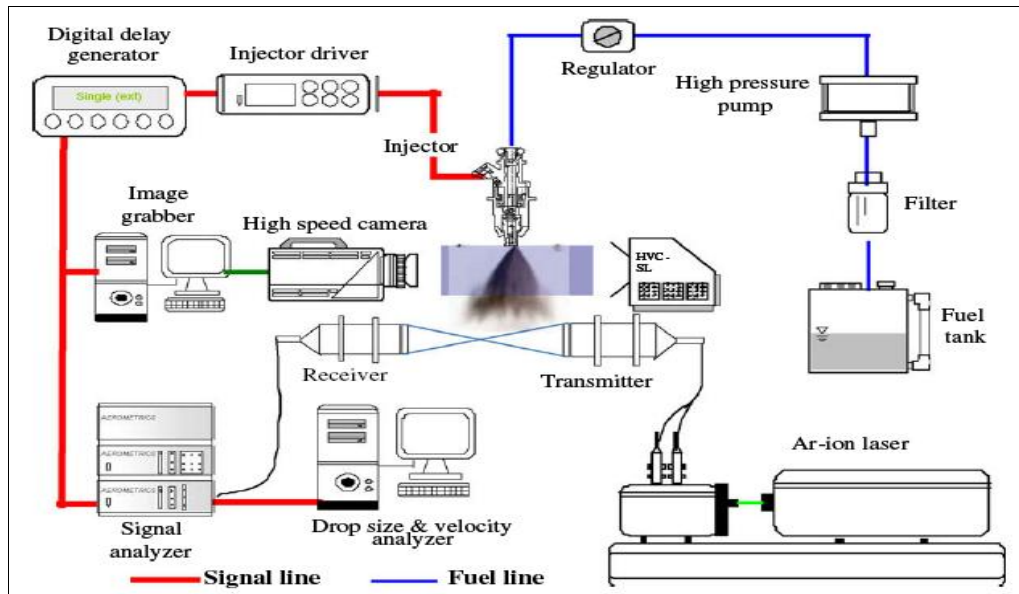
### **2.6.1 Atomization and spray characteristics of bio-ethanol blended gasoline (E100) and (E85)**

This study was done by Lee, et al. (2009) at Hanyang University, Korea. The focus of their study was to investigate the spray characteristics and atomization performance of gasoline fuel (G100), bio-ethanol fuel (E100) and bio-ethanol blended gasoline fuel (E85) in a direct in a direct injection gasoline engine. The overall spray and atomization characteristics and overall Sauter mean diameter (SMD) were measured experimentally and predicted by using KIVA-3V code.

#### **2.6.1.1 Experimental setup**

On this study, the high pressure swirl injector is used. This injector has a nozzle exit orifice diameter of 1.0 mm and is operated by varying electric voltages. The injection timing and energizing duration of the test injector were controlled by an injector driver (TEMS, TDA-3200H) and a digital delay/pulse generator (Berkeley Nucleonics Corp., Model 555). Spray evolution images were obtained using a high speed camera (Photron, Fastcam-APX RS) with two metal halide lamps.

Moreover, the high speed camera was synchronized with the injector driver by using the digital delay/pulse generator and the obtained images were stored in a computer with an image grabber. The frame rate of the high speed camera was maintained at 10,000 fps (frames per second). The droplet analysis system using an Ar-ion laser as a light source consists of a receiver, a transmitter, and a data processing system. The 2-dimensional traverse allows measurements at various measuring points.



**Figure 2.4:** Schematic of experimental setup.

Source: Lee, et al. (2009)

Visualization system	Frame rate	10,000 fps
	Shutter speed	1/20,000 s
	Resolution	512 × 512
PDPA system	Light source	Ar-ion laser
	Wave length	514.5 nm, 488 nm
	Focal length	500 mm for transmitter and receiver
	Collection angle	30°
	Burst threshold	0.5 mV
	Mixer frequency	36 MHz
	Filter frequency	40 MHz
	PMT voltage	500 V
	Signal-to-noise ratio	65
	Diameter sub-range	1.5–75 μm

**Figure 2.5:** Specification of the droplet analysis system and high speed camera.

Source: Lee, et al. (2009)

Visualization	Injection pressure ( $P_{inj}$ , MPa)	4, 6, 8
	Ambient pressure ( $P_{amb}$ , MPa)	0.1
	Energizing duration ( $t_{eng}$ , ms)	2
PDPA	Injection pressure ( $P_{inj}$ , MPa)	7
	Ambient pressure ( $P_{amb}$ , MPa)	0.1
	Energizing duration ( $t_{eng}$ , ms)	2.0

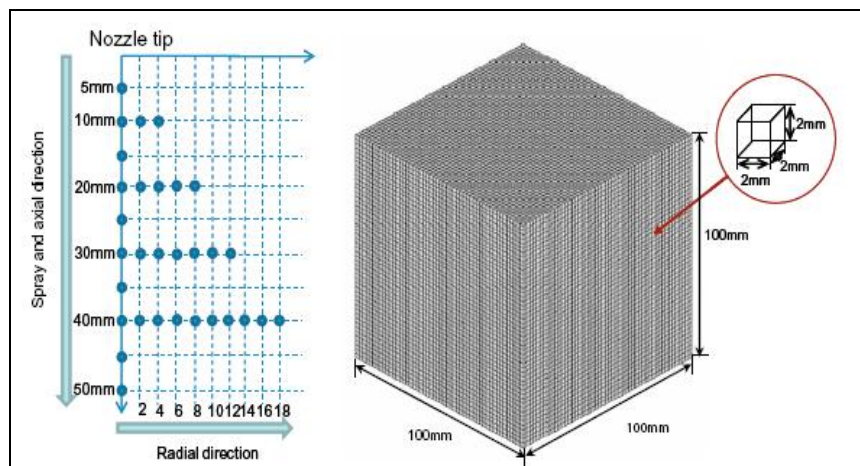
**Figure 2.6:** Experimental conditions.

Source: Lee, et al. (2009)

### 2.6.1.2 Numerical Analysis

For this experiment, fuel library was created on the basis of measured fuel properties such as surface tension, density and kinematic viscosity. Therefore, calculation of spray characteristics injected through the GDI injector were conducted after the fuel library of the test fuel is added and modified in KIVA-3D code. In this study, the linearized instability sheet atomization (LISA) model was used for analyzing the gasoline and bio-ethanol spray at the swirl type of injector. This model was proposed by Schmid et al. (1999) and has been widely used to simulate hollow cone sprays. The LISA model consists of three stages: film formation, sheet backup and atomization.

The calculation condition was used were same as the experimental condition shown in figure 2.6. The total number injected droplet was set to 5000. The spray angle and duration of pre-spray with nozzle hole diameter were determined to be  $10^\circ$  of a solid cone form and 0.1 milliseconds before the conversation of hollow cone, respectively. In order to analyzed spray characteristics, uniform cubic meshes with computational cell size of  $2 \times 2 \times 2$  mm were used, as illustrated in figure 2.7.

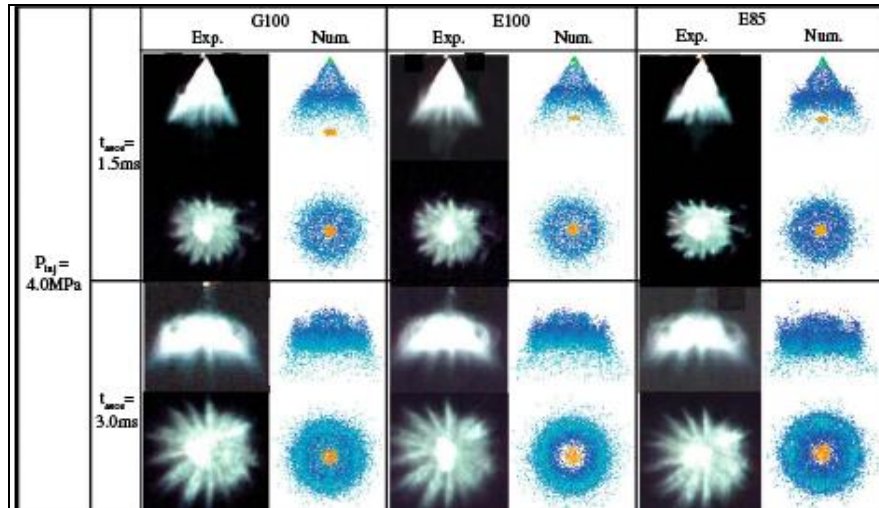


**Figure 2.7:** Measuring points for analysis of fuel droplet and the calculation meshes in KIVA code.

Source: Lee, et al. (2009)

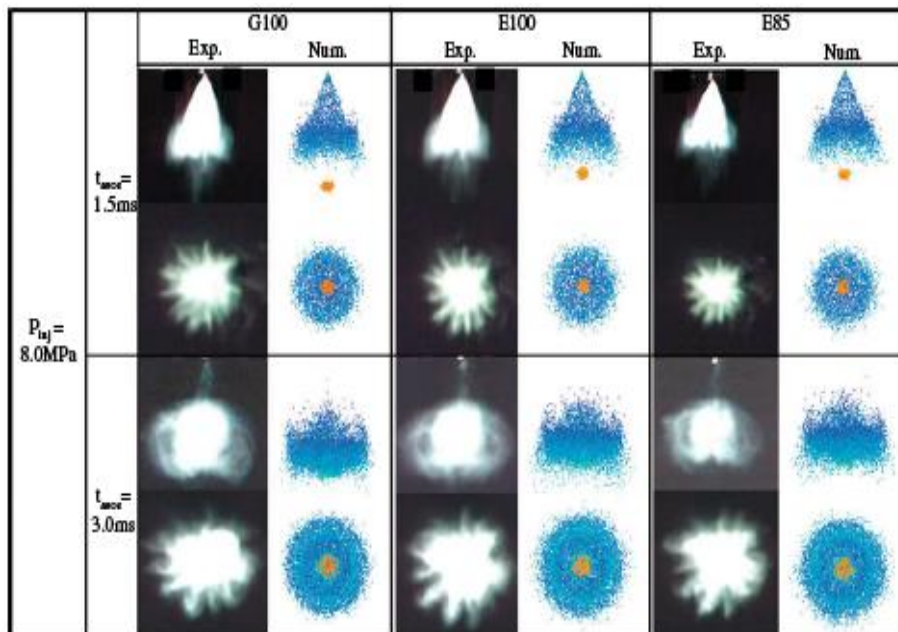
### 2.6.1.3 Results

Figure 2.8 and figure 2.9 shows that comparison between experimental and numerical analysis results.



**Figure 2.8:** A side and bottom view at condition of injector pressure was 4.0 MPa.

Source: Lee, et al. (2009)



**Figure 2.9:** A side and bottom view at condition of injector pressure was 8.0MPa

Source: Lee, et al. (2009)

## **2.6.2 Gasoline-Ethanol (Gasohol) Fuel Blend Spray Characterization using Digital Imaging and Image Processing**

This research was done by Amiruddin, et al. (2009). Their study is focus on characterize the spray of gasoline ethanol blends using schlieren imaging technique and image processing. Five different gasoline-ethanol fuel blend rates by volume are prepared. The Image of the spray is captured using schlieren imaging technique and image processing is employed to extract macro spray characteristics- spray tip penetration and spray cone angle. Based on the extracted tip penetration and cone angles E55 gasoline-ethanol blend found out to have the largest cone angle and tip penetration among the tested blends.

### **2.6.2.1 Experimental Setup**

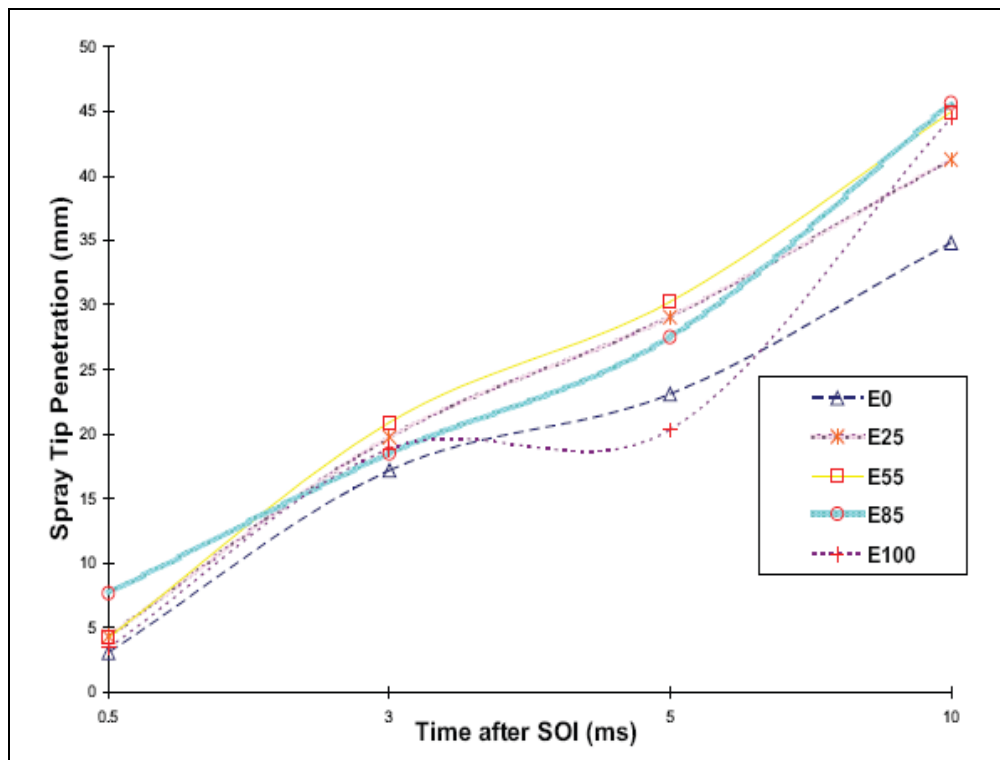
Two different fuel samples were experimentally investigated during this study. Unleaded gasoline was obtained from PETRONAS petrol station. Ethanol, with a purity of 99%, was used in preparing the blends. The unleaded gasoline was blended with ethanol to get 5 test blends ranging from 0% to 100% ethanol. The fuel blends were prepared just before starting the experiment to ensure that the fuel mixture is homogenous and to prevent the reaction of ethanol with water vapour. Various blend rates of gasoline-ethanol fuels (E0, E25, E55, E85, and E100) have been prepared by volume.

The ‘‘E’’ designates ethanol and the number next to E tells the volume percentage of ethanol. For instance, E25 means that 25% ethanol (99.9% purity) was blended with 75% gasoline. The fuel injection system comprised of fuel-pump test bench, injection controller and port injector. Fuel streamed from the pressure rail (3 bars) was injected openly where the temperature and pressure of air are at room environments in this experiment Imaging is achieved with a high speed video camera (Photron, FASTCAM-APX) operated at a speed of 16,000 frames per second with effective pixel size of 1280 x 1024. A Nikon 60 mm f/2.8D Micro-Nikkor lens was used to accompany the camera.



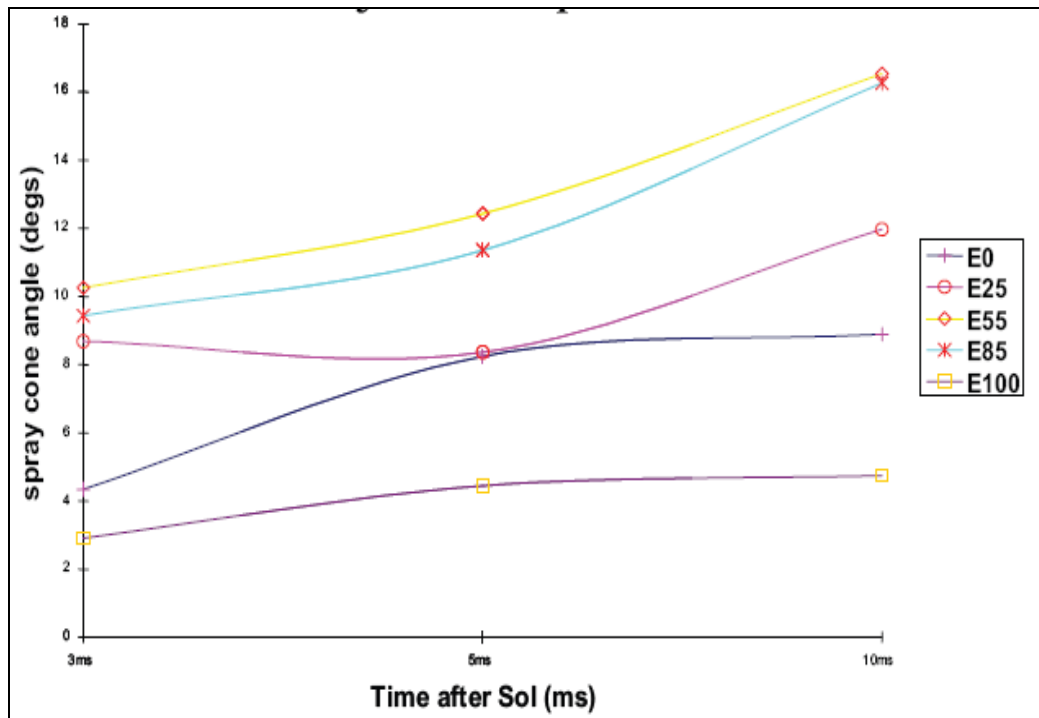
### 2.6.2.2 Result

Researcher convert pixel measurements to SI metric measurements a calibration image of a graduated scale is taken. The value of one pixel is found out to be equivalent to 0.422 mm. spray tip penetration can be found out as the vertical distance between the injector nozzle end and the furthest spray point along the spray axis of symmetry. Whereas the cone angle is calculated as the angle between the bounding lines of the spray at convenient distance of 20D where D is the injection hole clearance. The spray tip penetration of different blend rates are automatically computed and plotted with respect to their injection time as it is depicted.



**Figure 2.10:** Spray tip Penetration of different ethanol gasoline blends.

Source: Amirruddin et al. (2009)



**Figure 2.11:** Spray cone angle for different gasohol blends.

Source: Amirruddin et al. (2009)

## **CHAPTER 3**

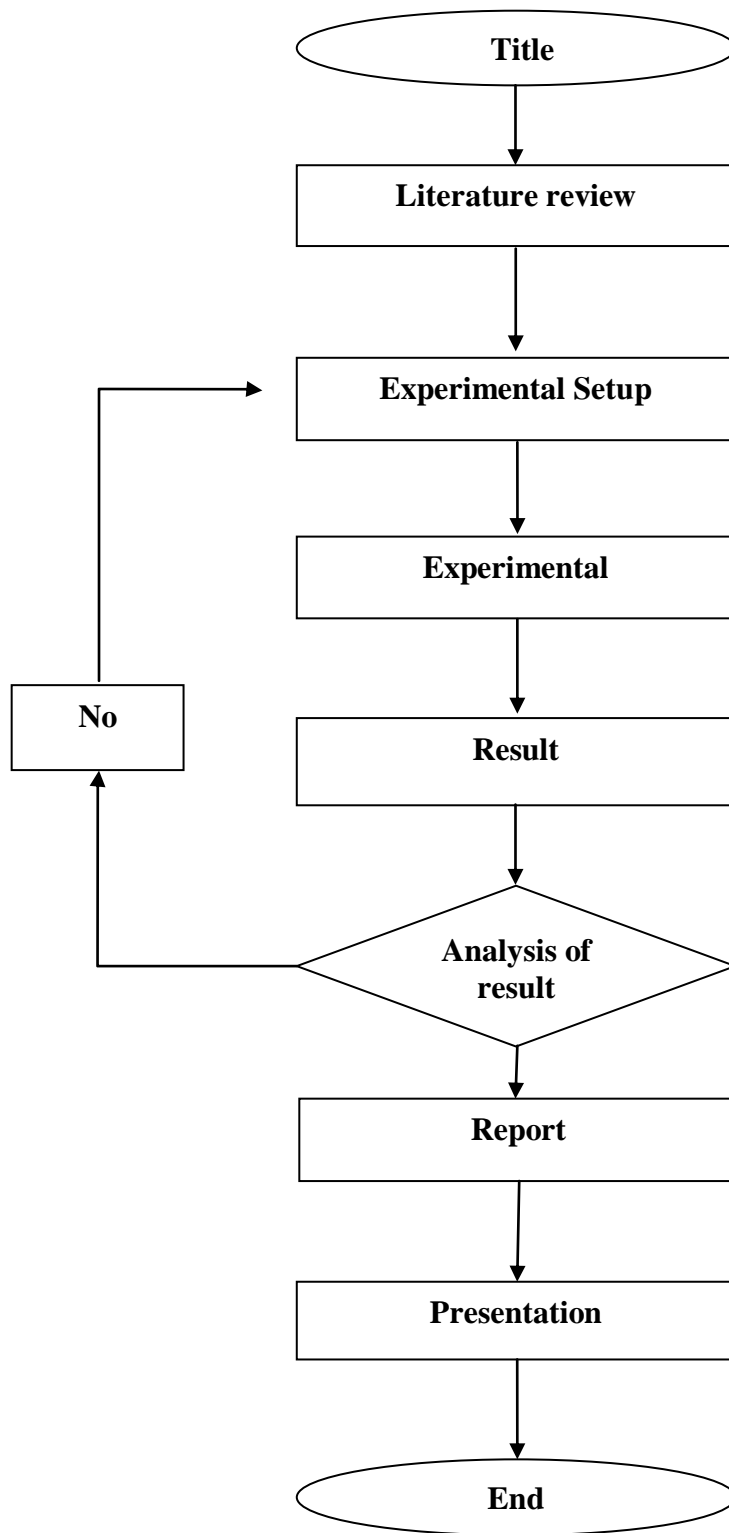
### **METHODOLOGY**

#### **3.1 INTRODUCTION**

This chapter concludes research methodology beginning with flow chart, experimental setup and equipment used and experimental conditions. Purpose of methodology is to describe in details on how experimental been done and what equipment is used.

#### **3.2 RESEARCH FLOW CHART**

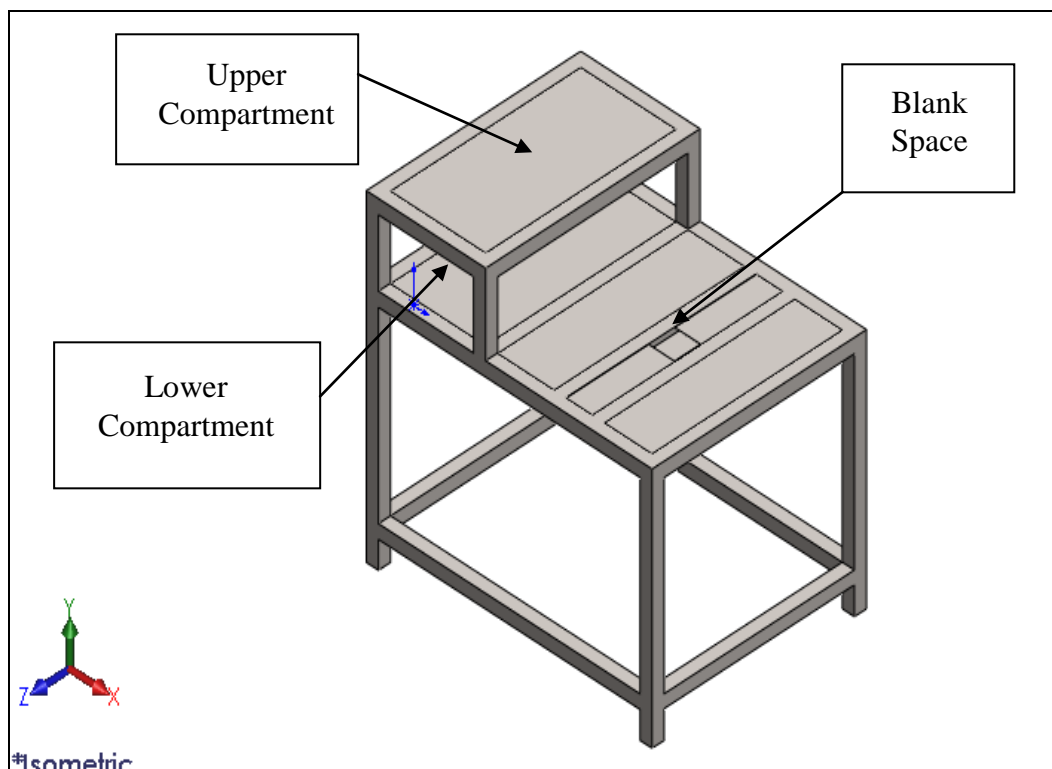
Overall this project is following the flow chart with the beginning of received and clarification of the title from supervisor. Identifications research background, problem statement, objective and scope are the second step for this research. Weekly appointments with supervisor also have been agreed. Literature reviews starts from finding books and journals that related to the title as a references to study. From literature review it is encourage making a decision on how to conduct the project and experimental. Next step, setup an experimental for this project was begun with preparing a test rig. The test rig is including high pressure chamber, injector, fuel tank, fuel filter, and fuel pump. After combining with optical measurement, it comes complete and ready to start the experiment. When experimental has been done and results are produce, images that captured by the optical measurement are analyzed to conforming it is following according to the objectives of study and if it doesn't follow the objectives, the experimental is modified until it accomplished the objective of the study. Research is ended with report documentation and presentation.



**Figure 3.1:** Project flow chart.

### 3.3 TEST RIG DEVELOPMENT

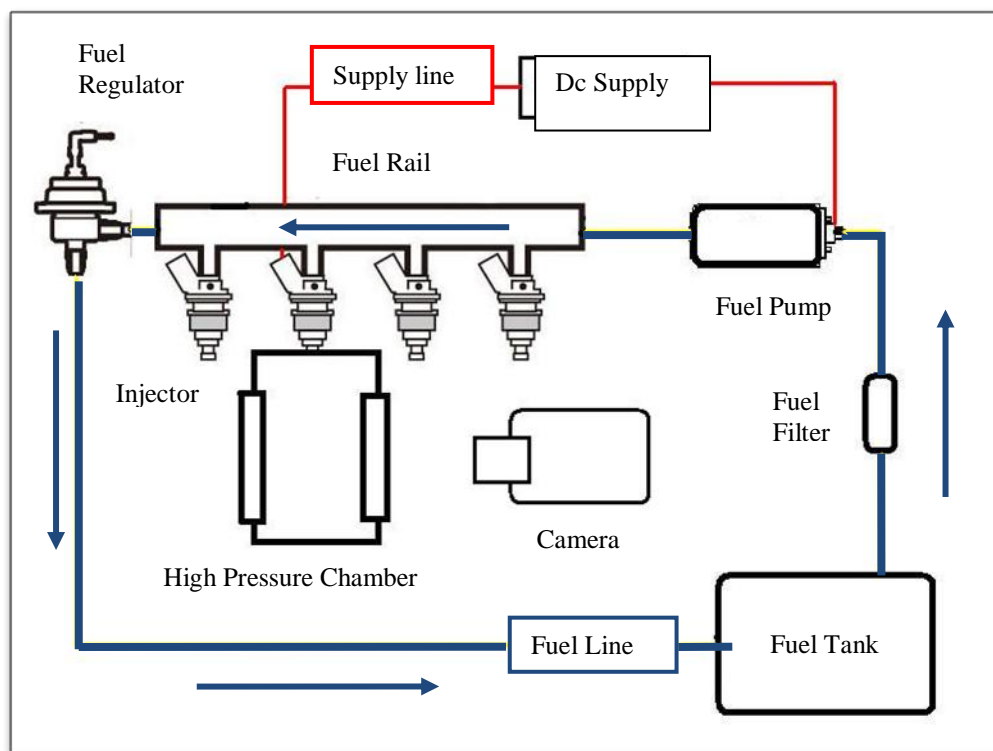
In order to setup the experiment, development of test rig has been done. CAD software was used to creating test rig design and ensure that all equipment used are located and suitable for run an experiment as illustrated in figure 3.2. Test rig is built using multiple of hollow square mild steel with dimension of 50.8 mm × 50.8 mm and thickness of 16 mm and 2 mm sheet metal. Highest height of the test rig is 1200 mm; length of test rig is 1100 mm and wide is 800 mm. For further details of test rig design dimension, it can be seen at appendix. Fabrication of test rig is using metal cutter and joining process using method of MIG Welding. Upper compartment is location for 12 litres fuel tank, fuel filter and high pressure pump. At lower compartment is where power supply, fuel pressure regulator and fuel injector with fuel rail are located. Blank space is a space for locating a high pressure chamber. Location is selected for an ease to conducting an experiment and optical measurement having enough space to measure spray characteristics.



**Figure 3.2:** Test rig design.

### 3.4 EXPERIMENTAL SETUP

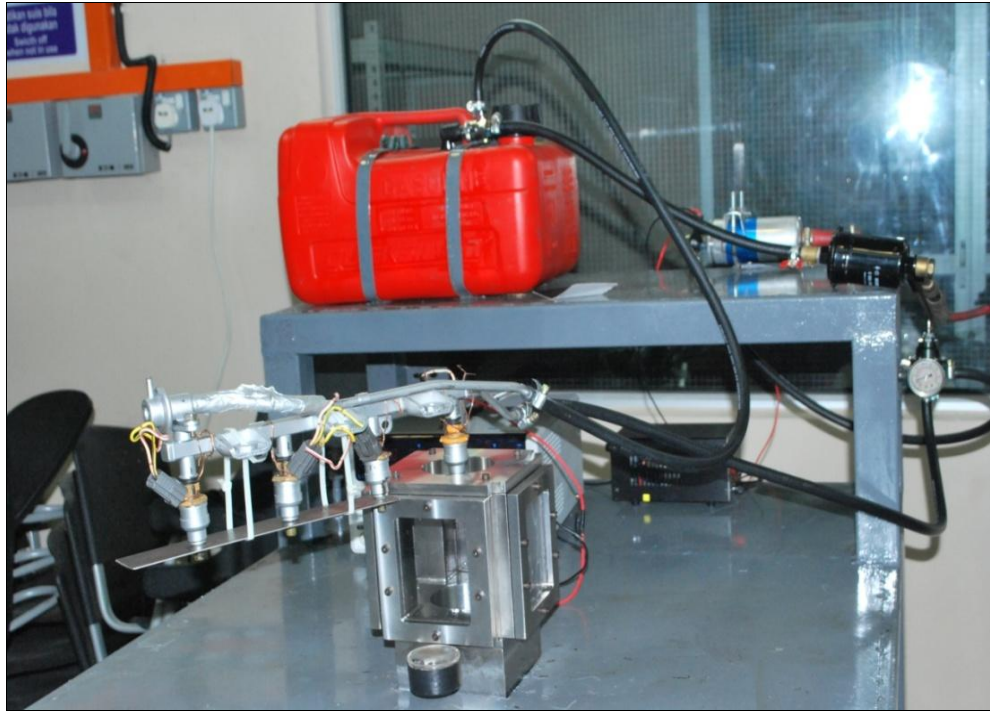
After many journals of experimental fuel spray have been read, it is decided to follow schematic diagram of experimental setup from previous study. Schematic diagram for current experimental setup as illustrated in figure 3.3. It consists of a high pressure chamber, a high pressure injector, a high pressure fuel supplying system, and digital camera to substitute high speed camera, fuel filter, fuel tank and fuel pressure regulator.



**Figure 3.3:** Schematic diagram for current experimental setup

The sequence starts from the high pressure pump supplying high pressure fuel with measured 4 bar to the fuel rail and fuel injector from a 12 litre fuel tank, which is filtered by a fuel filter. A fuel pressure regulator ensures that the pressure in the fuel rail is constant and returns any surplus fuel back to the tank. The injection timing of the test injector was controlled by a timer device circuit. To clarify the effect of ethanol fraction on the spray properties, experimental measurements have been carried out with ethanol-

gasoline blends (E10), in which the number indicates the ethanol volume percentages. Spray evolution images were obtained using a digital camera.



**Figure 3.4:** Actual experimental setup.

### **3.5 EXPERIMENTAL EQUIPMENT**

For fuel line, equipments used are fuel tank, fuel filter, high pressure pump, fuel pressure regulator and fuel injector. High pressure pump and injector was connecting by DC power supply,

#### **3.5.1 Fuel Tank**

This equipment is used as storage fuels that going to be used in experiment and receive any fuel return from fuel rail. It has two hose connector where horizontal hose connector is for fuel supply and vertical hose connector is for fuel return. For ethanol gasoline blends, volume percentage are measured by glass beaker then it mixes in the tank. Tank can store maximum of 12 litres of fuel.



**Figure 3.5:** Fuel Tank.

### **3.5.2 Fuel Filter**

Fuel filter is used to prevent an unwanted object from entering the pump. This experiment used a Bosch fuel filter for Proton Wira 1.6 cubic cylinder (cc) or 1.8 cc. This fuel filter also been used by other engine that intake system is using fuel injection system. An 8 mm diameter hose is used to connect from fuel take to inlet of fuel filter but the outlet connector is taken from the real engine before it is connected to high pressure pump.

### **3.5.3 High Pressure Fuel Pump**

A high-pressure pump made from Bosch Company that mostly used by Mercedes, Audi and Ford car models. It can run up to around 4 to 6 bar which supplies fuel to the fuel rail before fuel injectors. It is also has volume flow rate at 95 litres per hour which need a 12 Voltage supply from Direct Current Power Source. It has 15 mm diameter of outlet connector and 8 mm diameter of inlet diameter. Total length of this pump is 199 mm with diameter of 52 mm.

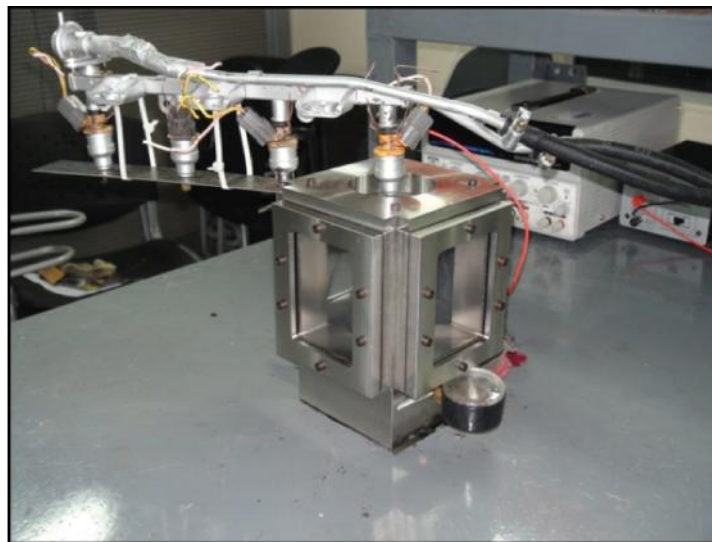


### 3.5.4 Fuel Pressure Regulator

A device that control the fuel pressure at a constant rate supply to fuel rail and returns any surplus fuel to the tank. Fuel pressure regulator used is small type which can measure until 11 bar and pressure adjustability 2.0 kgf/cm<sup>2</sup>.

### 3.5.5 High Pressure Chamber

High pressure chamber with outer dimension of 185 mm × 134 mm and inner dimension of 154 mm × 70 mm is used for this experiment. The chamber can measure pressure until 12 bar and having 5 mm glass thickness.



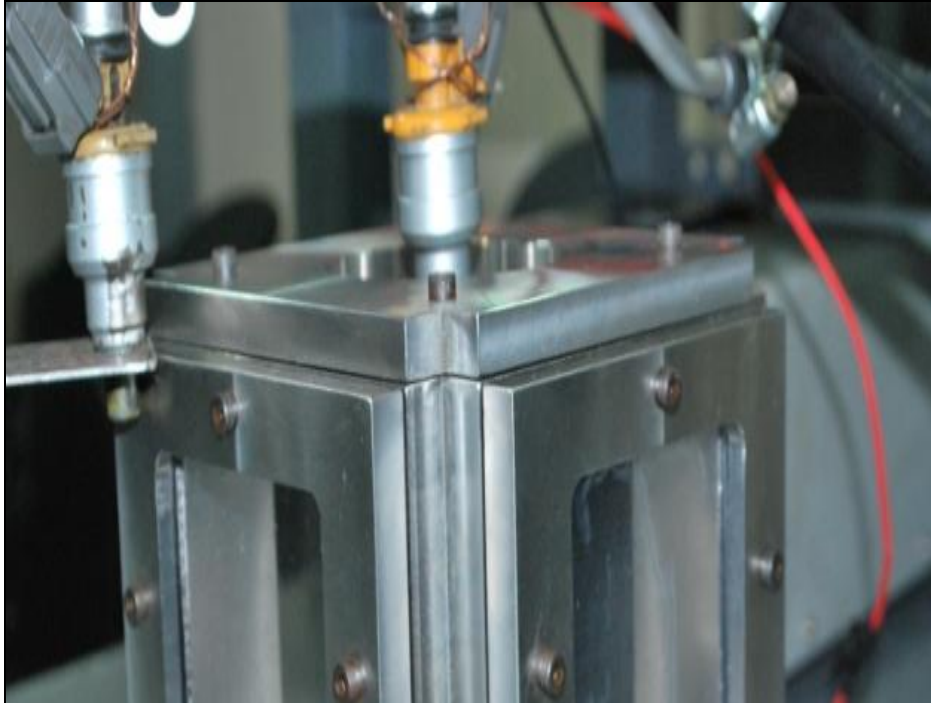
**Figure 3.6:** High Pressure Chamber.

### 3.5.6 DC Power Supply

Direct current to high pressure pump and fuel injector is supply from DC power supply that have 4 channel and adjustable voltage and ampere. For fuel injector it is supply 12 Volt and 0.25 Ampere on channel 2 but for fuel pump it is supply 12 Volt and 5.0 Ampere on channel 1.

### 3.5.7 Fuel injector

An electrical valve that will open to allow fuel to be injected into the high pressure chamber under high pressure when there is electrical supply. Operation condition is 12 Voltage supply with 0.2 to 0.4 Ampere. This experiment is using fuel injector with 1.0 mm needle.



**Figure 3.7:** Fuel Injector assembly.

### 3.5.8 Digital Camera

Because of limitation in this research occur, alternative to solve problems for optical study is by using digital cameras (**Nikon D90**). It comes with 12.3 megapixels. The D90 is the first DSLR to offer video recording, with the ability to record HD 720p videos, with mono sound, at 24 frames per second. Lens of this camcorder can provide aperture of F 1.8 to F 3.4 and 1/10000 of maximum exposure. Focus of this lens is between 5.0 mm to 50 mm.

## **CHAPTER 4**

### **RESULT AND DISCUSSION**

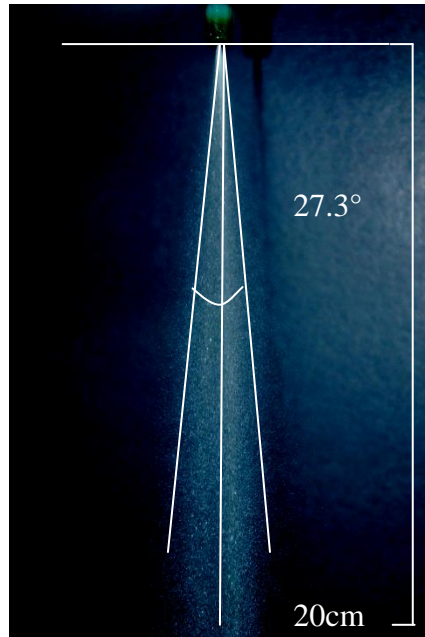
#### **4.1 INTRODUCTION**

This chapter deals with result of experimental fuel spray which is spray characteristics. Spray pattern also been display according to time frame from 10 ms to 40 ms. Volumetric flow rate for fuel injector also have been calculated.

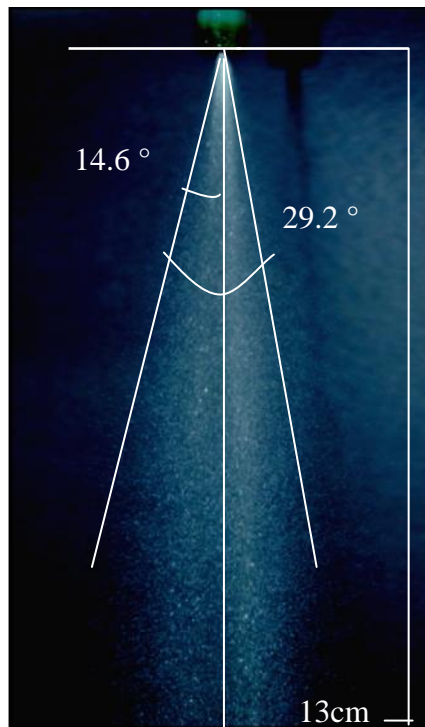
#### **4.2 EXPERIMENTAL SPRAY PATTERN**

Injector spray pattern is determined whether fuel injector having a good or weak spray. Fuel injector is hold at test rig but it is not attach to high pressure chamber, then power supply output switch is ON to give direct current to high pressure pump to supply a high pressure fuel to fuel rail also to fuel injector to open valve to inject. Optical measurement is set to capture spray pattern also spray characteristics during open spray test.

Figure 4.1 shows that spray pattern from fuel injector during injector spray pattern for E0 with  $27.3^\circ$  cone angle and 20 cm spray tip penetration. Figure 4.2 shows that spray pattern for E10 with  $29.2^\circ$  cone angle and 13 cm of spray penetration. Spray pattern shows that wide cone angle with good spray pattern without split stream. Result shows that E0 or Gasoline having longer penetration than E10 but smaller spray cone angle than E10. According to theory range for spray cone angle for GDI injector are  $20^\circ$  to  $30^\circ$ . So that result is acceptable.



**Figure 4.1:** Injector spray pattern for E0.



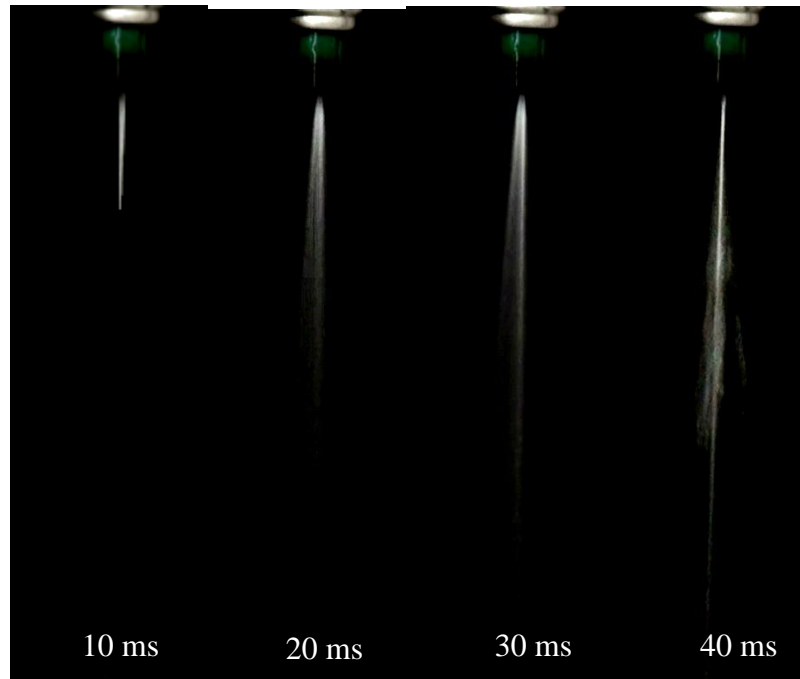
**Figure 4.2:** Injector spray pattern E10.

#### 4.2.1 Spray pattern according to time frame

Spray pattern was captured by digital camera at specified time. Video image had been analyzed from 10 ms until 40 ms. Figure 4.3 is image for E0 and figure 4.4 is image for E10. E10 is gasoline blends with ethanol where 90% volume of fuel is gasoline and another 10% volume of fuel is ethanol. But E0 is pure gasoline (RON95) that has been buying at petrol station. From experiment, it is shown that E0 spreads faster than E10. It is because E0 is having lower density and kinematic viscosity than E10.

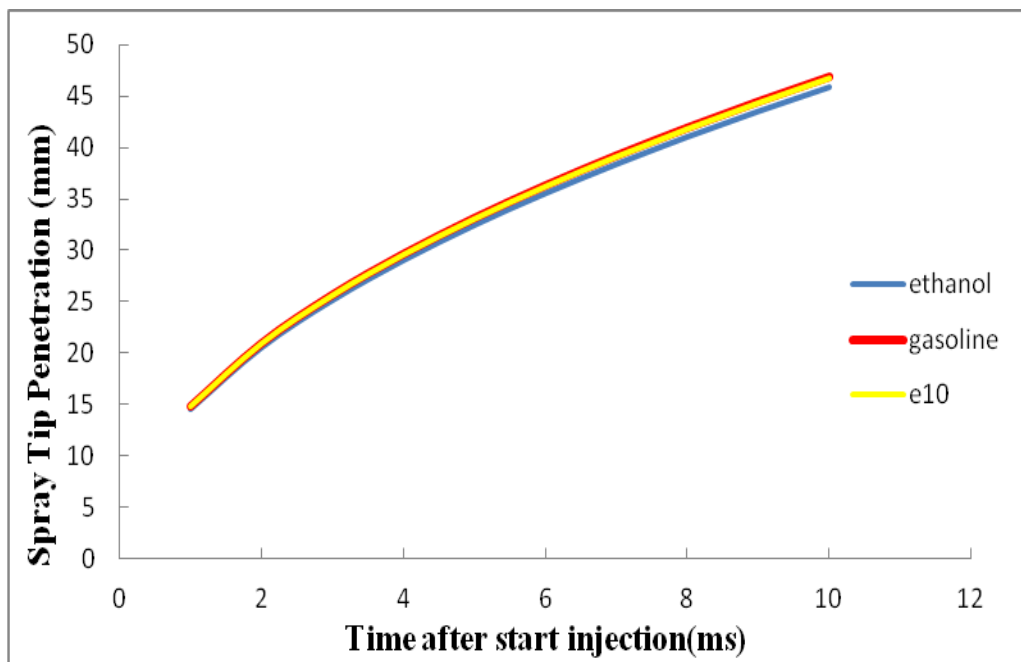


**Figure 4.3:** E0 during 10ms until 40ms.

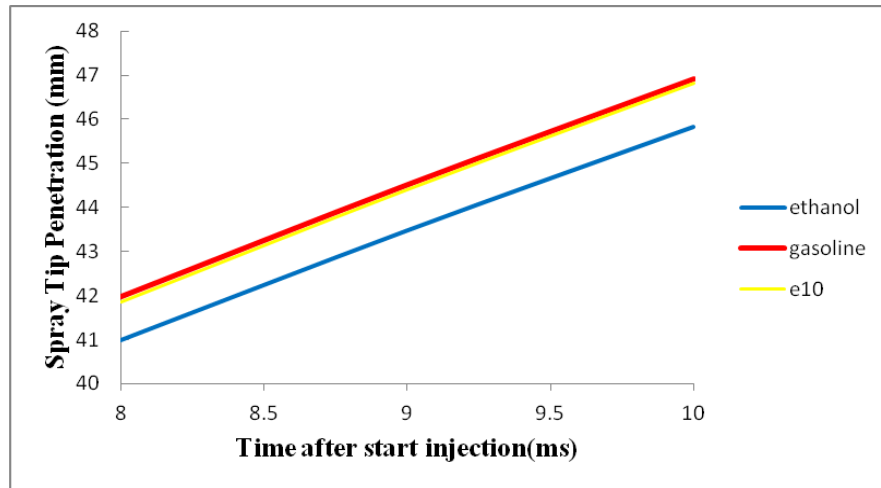


**Figure 4.4:** E10 during 10ms until 40 ms.

### 4.3 SPRAY TIP PENETRATION VERSUS TIME



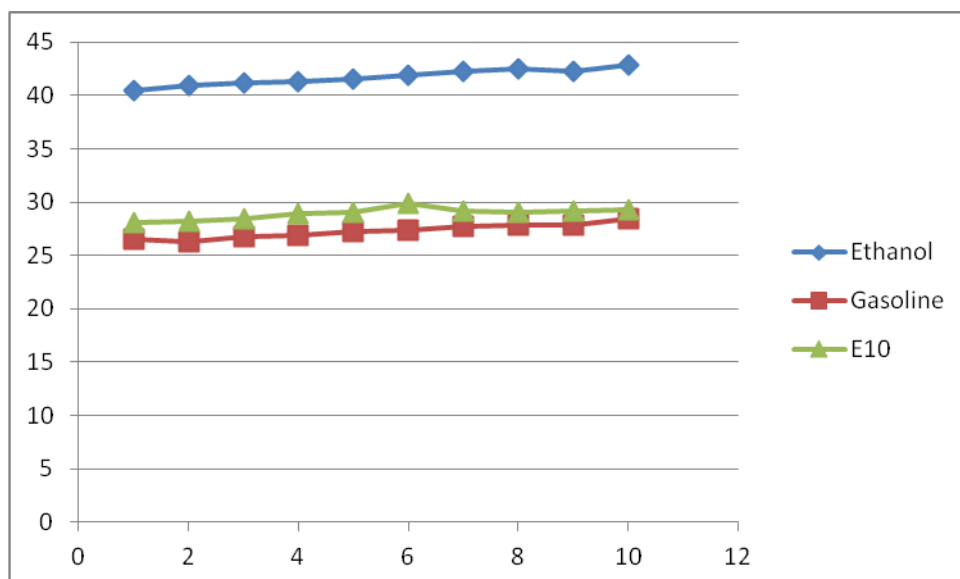
**Figure 4.5:** Graph spray penetration versus time after start injection for three different fuels.



**Figure 4.6:** Graph spray penetration versus time after start injection for three different fuels from 8 ms to 10 ms.

From the graph, penetration shows that three different fuels which are ethanol, gasoline and E10. Gasoline (E0) shows that longer penetration than other two fuels. Ethanol show the lower penetration and E10 is more closed to gasoline characteristic, it is because fraction of E10 is more to gasoline (E0) other than ethanol. So that the higher ethanol fraction in ethanol gasohol blends produce lower spray tip penetration.

#### 4.4 SPRAY CONE ANGLE VERSUS TIME



**Figure 4.7:** Graph spray cone angle versus time after start injection for Three different fuel

## 4.5 THEORITICAL CALCULATION

### 4.5.1 Flow Rate

Volumetric flow rate is determined from measuring spray time for 100 mL. Time is measured by Stopwatch while fuel spray is filling the beaker for 100 mL. Table 4.1 shows the three experimental data and average data is manually calculate for measuring flow rate.

Volume (mL)	Time (s)	Pressure (Bar)	Flow Rate (L/s)
100	41.32	4.0	$2.42 \cdot 10^{-3}$
100	40.76	4.0	$2.45 \cdot 10^{-3}$
100	40.87	4.0	$2.44 \cdot 10^{-3}$

**Table 4.1:** Volumetric flow rate measuring.

### 4.5.2 Spray characteristics

Spray tip penetration and spray cone angle are determine from formula 4.1 and 4.2 by Heywood, (1988) and value from table 4.2 by Lee et al. (2009) in his journal title Atomization and spray characteristics of bioethanol and bioethanol blended gasoline fuel injected through a direct injection gasoline injector.

Properties	Gasoline	Ethanol	E10
Density (kg/m <sup>3</sup> )	718.33	789.67	725.46
Kinematic Viscosity (mm <sup>2</sup> /s)	0.84	1.57	0.913
Surface Tension (N/m)	0.024	0.027	0.024

**Table 4.2:** Fuel Properties.

Source: Lee et al. (2009)



$$\text{Spray tip penetration} = S = 3.07 \left( \frac{\Delta P}{\rho} \right)^{1/4} (t d_n)^{1/2} \left( \frac{294}{T} \right)^{1/4} \quad (4.1)$$

Where  $t$ , time after start injection in unit is second,  $\Delta P$  is pressure in unit Pascal,  $d_n$  is diameter of exit orifice nozzle in unit Meter,  $\rho$  is density in unit kilogram per cubic meter and  $T$  is temperature in unit Kelvin.

$$\text{Spray Cone angle} = \alpha = 0.05 \left( \frac{d_{inj}^2 \rho \Delta P}{\mu^2} \right)^{0.25} \quad (4.2)$$

Where  $d_{inj}$  is a diameter of exit orifice nozzle in unit meter,  $\rho$  is density in unit kilogram per cubic meter,  $\Delta P$  is pressure drop in exit of nozzle in unit Pascal and  $\mu$  is dynamic viscosity in unit kilogram per unit meter and second.

In this study, it has determine time after start injection from 0 ms until 10 ms, pressure as 4 Bar or 400 kPa, diameter nozzle is 1.0 mm, density is according to table 4.2 and temperature as ambient temperature 300 K. Calculation was done for Ethanol (E100), Gasoline (E0) and Gasohol (E10); and results are shows in table 4.3 and table 4.4 also figure 4.5 and figure 4.6. Figure 4.5 shows that graph trend spray tip penetration (mm) versus time after start injection (ms) and figure 4.6 is focus on time after injection between 8 ms to 10 ms.

Time after start injection(ms)	Spray Tip Penetration (mm)		
	Ethanol	Gasoline	E10
1	14.49	14.84	14.80
2	20.49	20.98	20.93
3	25.10	25.70	25.64
4	28.98	29.68	29.60
5	32.40	33.18	33.10
6	35.50	36.34	36.26
7	38.34	39.26	39.16
8	40.99	41.97	41.87
9	43.47	44.51	44.40
10	45.82	46.92	46.81

**Table 4.3:** Spray tip penetration.

Type of fuel	Spray cone angle
Ethanol	40.5
Gasoline	26.5
E10	28.1

**Table 4.4:** Spray cone angle.

Result shows that the theoretical calculation for spray tip penetration E0 from 0 to 10ms is from 14mm to 45mm while the actual experiment is from 14mm to 47mm. Spray tip penetration for E10 and ethanol fuel is approximately like to the theoretical value E0 or Gasoline having longer penetration than E10 but smaller spray cone angle than E10. According to theory range for spray cone angle for GDI injector are 20° to 30° for E10. So that result is acceptable. Result from calculation and image spray pattern shows that gasoline or E0 is having longer spray tip penetration than E10 but having smaller spray cone angle than E10.

## CHAPTER 5

### CONCLUSION AND RECCOMENDATION

#### 5.1 INTRODUCTION

This chapter conclude all have been done and achieve in this research and recommendation on how to improve in future research to get a better result.

#### 5.2 CONCLUSION

Overall of this project is achieved to study about spray characteristics of ethanol blended gasoline fuel as well as pure gasoline in a direct injection gasoline injector of a gasoline engine. Spray characteristics including spray angle, spray tip penetration and spray width. Investigation of the spray characteristics of different ratio of gasohol fuel blends can be done using optical measurement. Then analysis qualitative result from experimental. Decision to choosing specific fuel injector and optical measurement, setup test rig for experimental using high pressure chamber and choosing fuel blends as a sample to doing experimental is refer to literature review.

Choosing fuel blends E0 and E10 as a sample to doing experimental and differentiate characteristic between two fuels. Spray characteristics that focus only on spray angle and spray tip penetration. After test rig fabrication is done and all equipment has been setup, experiment is start by supplying pressure at 4 bar from high pressure pump to fuel injector that attach to high pressure chamber. Ambient temperature was set to 300 K and ambient pressure is 0.1 MPa. While injector is spray a video imaging recording and result was display according to time frame. Video imaging has been analyzed and result is compared according spray evolution by time but the image is not good as image was capture by high speed camera.

Next, calculation for flow rate and spray tip penetration is done and graph display to differentiate according to fuel. From the experimental result it can conclude that E0 or gasoline having a longer spray penetration than E10 but having smaller spray cone angle.

### **5.3 RECOMMENDATION**

Recommendation for this research is to upgrade control system of injector timing with delay pulse generator and images grabber that can be synchronize to high speed camera and computer. Capturing image of fuel spray pattern by using high speed camera can be resulting the best picture of spray pattern. Another recommendation is analyzing spray characteristics and compared with prediction of simulation and the fuel spray atomization using velocity vector or using Phase Droplet Particle Analyzer or commonly known as PDA. Lastly, investigation of optical study of ethanol gasoline blends with increasing pressure and temperature inside high pressure chamber also can be done for future research.

## REFERENCES

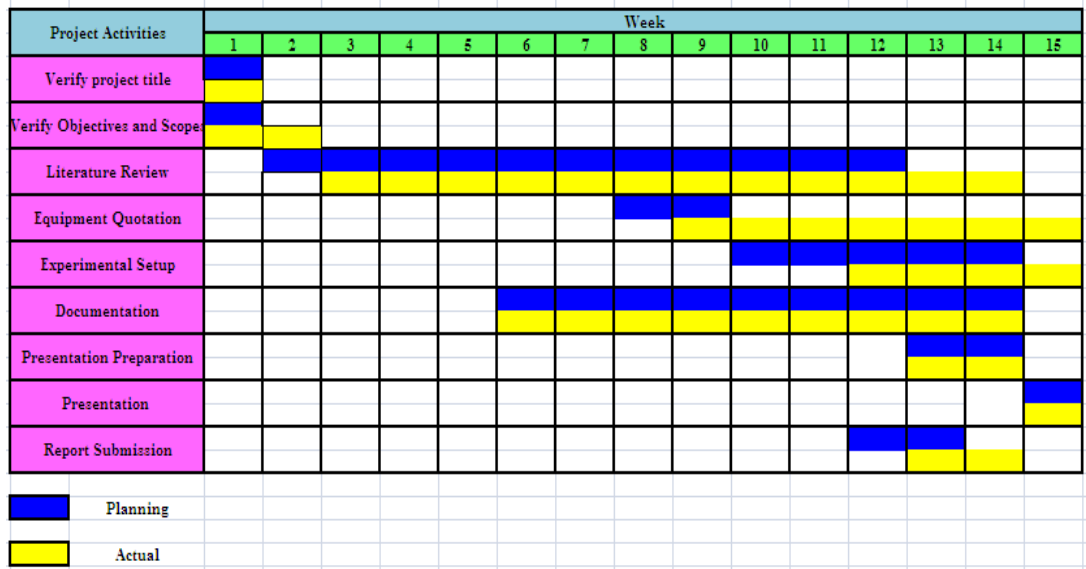
- Amirruddin, A.K., Razali, M. H., Firmansyah, S., Anwar, S. And Rashid, A., 2009. Gasohol blends Spray Visualisation by Using Video Image. Proceedings of MUCEET 2009. Universiti Malaysia Pahang and University Technology of Petronas, Malaysia.
- Bell, A.G., 1998. Four Stroke Performance Tuning. Haynes Publishing. United Kingdom.
- Chang, W., Kim, Y., Kong, J., 2007. Design and development of a spray-guided GDI engine. SAE Technical Paper. 2007-01-3531.
- Gao, J., Jiang, D., Huang, Z., 2007. Spray properties of alternative fuels: a comparative analysis of ethanol-gasoline blends of gasoline. International Journal of Fuel 86. Xi'an Jiaotong University, China.
- Hollebeak, B., 2006. Automotive fuels and emissions. Delmar learning, New York.
- Heywood, J. B., 1988. Internal combustion engines. Mc-Graw Hills. New York.
- Iffa, D.E., Amirruddin, A.K., Anwar, S.S., Rashid, A., Aziz, A., 2009. Gasoline-Ethanol (Gasohol) fuel blends characterization using digital imaging and image processing. IEEE International Conference on Signal and Image Processing Applications. Universiti Malaysia Pahang and University Technology of Petronas, Malaysia.
- Kawahara, N., Tomita, E., Kasahara, D., Nakayama, T., Sumida, M., 2004. Fuel breakup near nozzle exit of high-pressure swirl injector for gasoline direct injection engine. SAE Technical Paper. 2004-01-0542.
- Keith O., Trevor C., 1995. Automotive fuels reference book. 2<sup>nd</sup> edition. SAE . New York.
- Kim, S., Kim, Y., Lee, J., 2008. Analysis of the in-cylinder flow, mixture formation and combustion processes in a spray-guided GDI engine. SAE Technical Paper. 2008-01-0142.
- Lee, C.S., Chon, M.S., Park, Y.C., 2001. Spray structure of high pressure gasoline injector in a gasoline direct injection engine. International Journal of Automotive Technology.

- Lee, C.S., Lee, K.H., Chon, M.S., Kim, D.S., 2001. Spray structure and characteristics of high pressure gasoline injectors for direct injection engine application. *International Journal of Atomization and Sprays* 11.
- Lee, C.S., Suh, H.K., Kim, H.J., Park, S.H., 2009. Atomization and spray characteristics of bioethanol and bioethanol blended gasoline fuel injected through a direct injection gasoline injector. *International Journal of Heat and Fluid Flow* 30. Hanyang University, Republic of Korea.
- Powell, J.W., Lee, C.F., 2007. An investigation of multiple scattering in a hollow-cone spray. SAE Technical Paper. 2007-01-0648.
- Pulkrabek, W., W., 2004. *Engineering Fundamentals of Internal Combustion Engines*. Pearson Prentis Hall. New York.
- Wang, X., Gao, J., Jiang, D., Huang, Z., Chen, W., 2005. Spray characteristics of high pressure swirl injector fuelled with methanol and ethanol. *International Journal of Energy and Fuels* 19.
- Yuksel, F., Yuksel B., 2003. The use of ethanol–gasoline blends as a fuel in an SI engine. *International Journal of Renewable Energy* 29. University of Ataturk, Erzurum, Turkey.

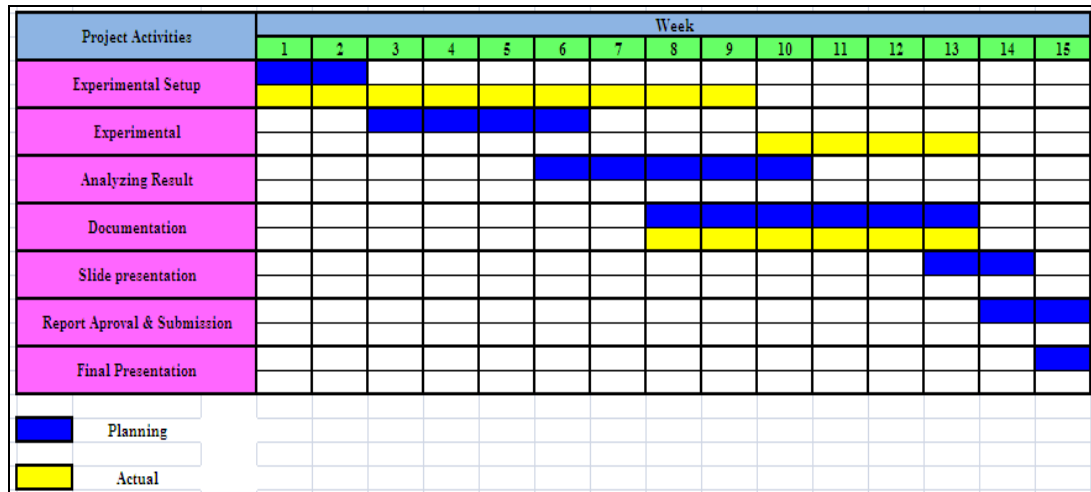
## APPENDIX A

### GANTT CHART

#### FYP 1



#### FYP 2





# APPENDIX B

## TEST RIG DESIGN DIMENSION

