

# CHAPTER 1

## INTRODUCTION

### 1.1 Background

During the author's eight months of industrial training at Plant Operation Division, PETRONAS Gas Kerteh, numerous shutdowns of the heat exchangers were attributed to failure of the heat exchanger tubes. One of the heat exchangers involved is designated as T-831 and this heat exchanger contains most of the tubes that failed.

During this internship program, various suspected cause of failures of the heat exchanger was discussed and this caught the author's attention to do a proper investigation.

### 1.2 Problem statement

The failures of tubes in heat exchanger T-831 in Kerteh resulted carry unnecessary downtime to GPP Kerteh. The heat exchanger is shown in Figure 1. The tubes failure occurs approximately once every two years. Various opinions and suggestions have been given as the possible cause of failure. However a proper failure analysis study has not been performed. There were no study done to analyze the relations between the possible causes of problem, the exercised maintenance, and the implemented operation.



Figure 1 : Heat exchanger T-831

### **1.3 Objective and Work Scope**

The objective of this project is to determine the causes of premature failures of heat exchanger tubes for Propane Refrigerant Condenser (T-831) in GPP Kerteh. This task consists of employing failure analysis methods in order to examine and investigate the possible causes of failure. Scope of work will include investigation of the material properties, review of regular operation parameter used, and inspection of maintenance activities conducted on the heat exchanger. It is anticipated that at the end of project, author will be provide suggestions in order to reduce the failures of the heat exchanger tubes.

### **1.4 Significance of Study**

Based on the author's experience during industrial training at GPP Kerteh, equipment's shutdown activity involves a large amount of manpower and money. The company needs to spend approximately RM 3,000,000 per equipment. In addition, maintaining or fixing problem and assembling the equipment need at least three workdays. It anticipated that by properly identifying the cause of failure of these heat exchanger tubes, the problem arising from production interruption can be reduced.

## **CHAPTER 2**

### **LITERATURE REVIEW**

#### **2.1 Failure Analysis Process**

According to ASM Handbook<sup>®</sup> Volume 11, Failure Analysis and Prevention (page 395-415), failure analysis practices consist of background data collection and sample selection, preliminary examinations, nondestructive examination (NDT), macroscopic examinations, microscopic examinations, metallographic examination, fracture mechanics, mechanical testing, chemical analysis, corrosion analysis, wear failure, formulating conclusion and report writing [1][2]. These practices are discussed in the following subsections.

##### **2.1.1 Background Data Collection and Sample Selection**

Service history data, photographic reports, samples, any abnormal condition, and wreckage analysis are gathered. The availability of a complete service history depends on how detailed the record keeping was prior to the failure. A complete service record greatly simplifies the assignment of the failure analyst. In collecting service histories, environment details such as normal and abnormal loading, accidental overloads, cyclic loads, temperature variation, temperature gradient, and operation in a corrosive environment should be given more attention.

Photograph of the failed component or structure are often times critical to an accurate analysis. A detail that appears almost inconsequential in a preliminary investigation may later be found to have serious consequences: thus, a complete, detailed photographic record of the scene and failed components can be essential.

For better results and reference, photographs should be of professional quality. Technique, lighting and proper type of camera should be used in increasing capability of producing excellent results. Some indication of size, such as scale, coin, hand, and so forth, should be included in the photograph.

Sample should be selected judiciously before starting the examination, especially if the investigation is to be lengthy or involved. The analyst must ensure that the

samples are fulfilling the requirement of the investigation in order to represent the characteristics of failure.

In addition to developing a history of the failed part it is also advisable to determine if any abnormal conditions prevailed. It is also necessary to inquire whether or not the failure was an isolated example or if others have occurred previously, either in the component under consideration or others.

### **2.1.2 Preliminary Examination**

Preliminary Examination consist of visual inspection and photography of the damaged or failed part, this part plays role as in establishing the cause of failure or in determining a sequence of events leading to the failure.

Unaided visual inspection has exceptional depth of focus, the ability to examine large area rapidly and to detect changes of colour and texture.

When fracture is involved, the entire fractured, including broken pieces should be examined and photographed to record their size and condition and to show how the fracture is related to the component. The examination should begin with the use of direct lighting and various angles of oblique lighting to delineate and emphasize the fracture characteristics.

### **2.1.3 Nondestructive Examination**

Nondestructive examination (NDT) is often used as a quality-control tool. Magnetic particle inspection, ultrasonic inspection, and eddy current inspection are several tests used in failure investigation. All test involved are used to detect surface crack and discontinuity. X-ray and radiography are used mainly for internal examination. This method can be used in failure analysis as a reveal any outstanding condition without damaging or destructing the sample. As the result, subsequent testing and examination can be executed according to the outcome of NDT.

### **2.1.4 Macroscopic Examination**

Performed at magnifications less than 100×, it may be conducted by the unaided eye, a handheld lens, a magnifier, a low-power stereoscopic microscope, or a scanning

electron microscope (SEM). Specimen can be coated with a thin layer (about 20nm) of vacuum deposited gold or carbon to improve their conductivity, or they may be shadowed at an angle to increase the contrast of fine details. Conductive coated replicas may be also examined with SEM.

### **2.1.5 Microscopic Examination**

Typically done using an SEM, it has advantage over light microscopy because of the large depth of field and very high magnifications attainable, typically 5000 to 10000 $\times$ . In addition, SEMs are often equipped with microanalytical capabilities, for example, energy-dispersive x-ray spectroscopy (EDS). Chemical analysis can be helpful in confirming the chemistry of microstructural features that may be confused with fracture features.

### **2.1.6 Metallographic Examination**

Metallographic examination of polished and polished-and-etched section by optical microscopy and by electron-optical technique is a vital part of failure investigation and should be carried out as a routine procedure when possible. This method can provide information about the class of material involved and its structure, effect of unsuitable composition or service, method of manufacture of the part, heat treatment, and deficiencies in heat such as decarburization at that surface.

### **2.1.7 Fracture Mechanics**

The application of fracture mechanics is often pertinent to the investigation of failure, as well as to the formulation of preventive measure. In general, there are two types of conditions that may lead to structural failure:

- Net-section instability where the overall structural cross section can no longer support the applied load
- The critical flaw size is exceeded by some preexisting discontinuity or when subcritical cracking mechanisms (for example, fatigue, SCC, creep) reach the critical crack size.

### **2.1.8 Mechanical Testing**

Hardness testing is the simplest of the mechanical test and is often the most versatile tool available to the failure analysis. Among its many application, hardness testing can be used to assist in evaluating heat treatment (comparing the hardness of the failed component with that prescribed by specification), to provide an estimate of tensile strength of steel, to detect work hardening, or to detect softening or hardening caused by overheating, decarburization, or by carbon or nitrogen pickup.

### **2.1.9 Chemical Analysis**

Analysis of surfaces and deposits normally used wavelength-disperse x-ray spectrometer (WDSs) and EDSs are frequently used for providing information regarding the chemical composition of surface constituents. They are employed as accessories for SEMs and permit simultaneous viewing and chemical analysis of a surface.

### **2.1.10 Corrosion Analysis**

There are many methods in investigating the main cause of failure such as on-site examination and sampling, preliminary laboratory examination, chemical analysis on corrosion and corrosion testing. Several types of corrosion are discussed briefly in Section 2.3.

### **2.1.11 Wear failure**

A system approach to wear is necessary to understand the interaction among:

- The system material component – the bulk and surface properties of the wearing parts, the properties of the material causing the wear, and the interface medium;
- The operating variables;
- The interaction among the material components of the system;
- The operating environment;

There are eight major forms or mechanism of wears such as abrasive wear, erosive wear, adhesive wear, fretting, cavitations, liquid-droplet impingement, rolling-contact fatigue and corrosive wear.

### **2.1.12 Formulating Conclusion and Report Writing**

Where extensive laboratory facilities are available to the investigator, maximum effort will be devoted to amassing the results of mechanical testing, chemical analysis, fractography, and microscopy before the formulation of preliminary conclusion is attempted. In addition, any tendency to curtail work essential to an investigation should be guarded against. In some instances, it is possible to form an opinion regarding the cause of failure from a single aspect of the investigation, such as visual examination of a single metallographic specimen. However, before final conclusion are reached, supplementary data confirming the original opinion, if available, should be sought.

A failure analysis report is summation of the entire individual test and analyses performed during the course of an investigation. The report coalesces the various results and presents them in a concise and logical format. It should be written to describe the particulars of the subject being studied, convey pertinent information gathered from testing and analysis, and logically and accurately interpret and explain data and result.

There are few elements of report writing which minimally consist of an introduction that includes background information of the subject, a section of investigation details and conclusion. While lengthier report can comprise a heading, abstract, table of content, introduction, section devoted to investigative procedure, result, discussion, conclusion, and recommendation; signature blocks, acknowledgement, reference and appendices.

## **2.2 Heat Exchanger design**

In designing heat exchangers, there are basics heat exchanger design topics concerning shell-and-tube heat exchangers (STHE) components, classification of STHEs according to construction and according to service, data needed for thermal design, tubeside design, shellside design, including tube layout, baffling, and shellside pressure drop, and mean temperature difference. The basic equations for tubeside and shellside heat transfer and pressure drop are well known. Here we focus on the application of these correlations for the optimum design of heat exchangers [3].

It is essential for the designer to have a good working knowledge of the mechanical features of STHEs and how they influence thermal design. The principal components of an STHE are shell, shell cover, tubes, channel, channel cover, tube sheet, baffles and nozzles. There are various designs of heat exchangers components described in Standards of the Tubular Exchanger Manufacturers Association (TEMA).

An STHE is divided into three parts such as the front head, the shell, and the rear head. Figure 2 illustrates the TEMA nomenclature for the various construction possibilities. Exchangers are described by the letter codes for the three sections; for example, a BFL exchanger has a bonnet cover, a two-pass shell with a longitudinal baffle, and a fixed-tubesheet rear head. According to construction, the type of heat exchanger is divided into fixed-tubesheet heat exchanger, U-tube heat exchanger and floating-head heat exchanger.



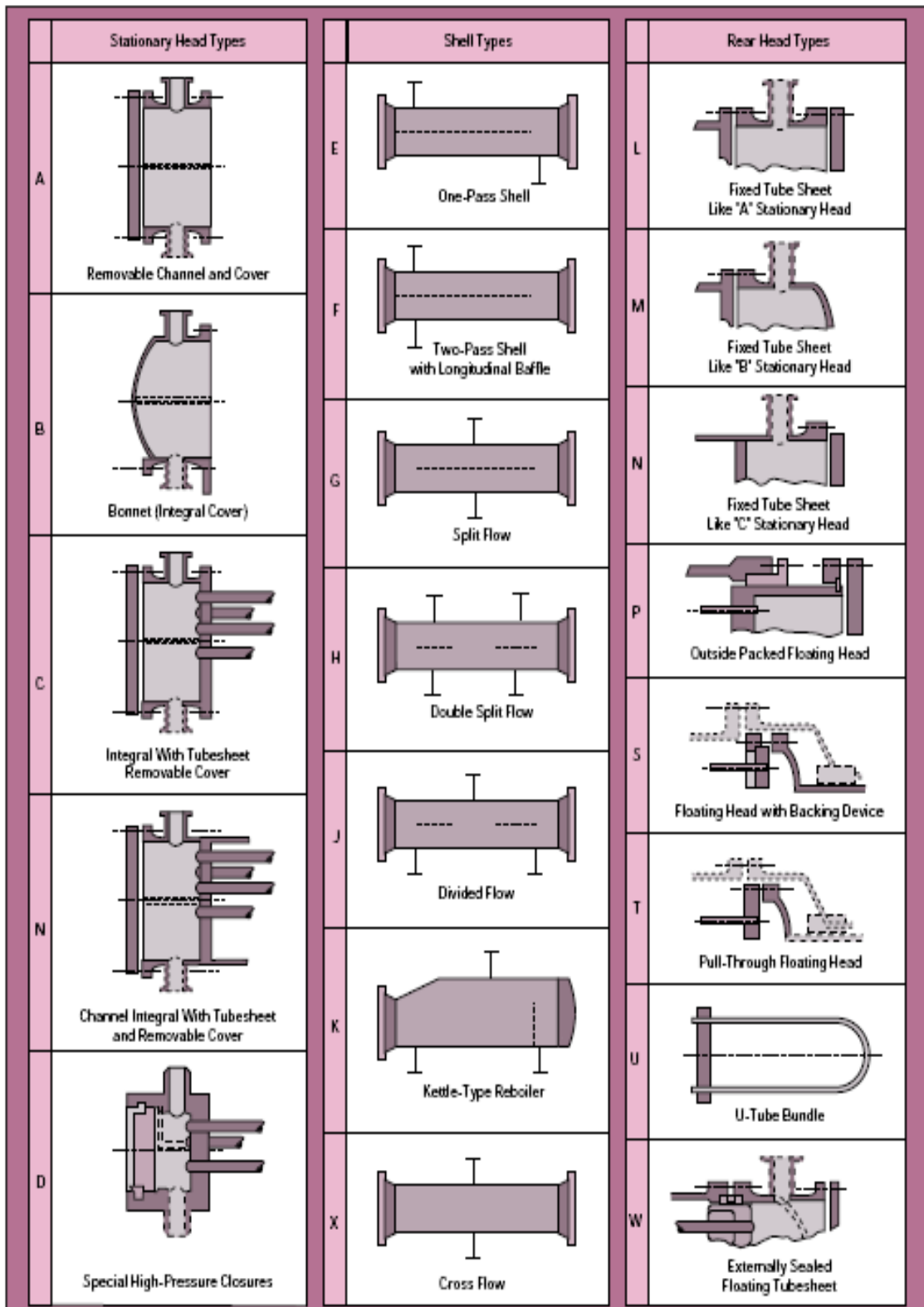

Figure 2 : TEMA designations for shell-and-tube heat exchangers [3].

The main data required in the design for the tubes of heat exchanger consists of tube layout pattern, tube pitch, and baffling. There are four tube layout patterns, as shown in Figure 3, triangular ( $30^\circ$ ), rotated triangular ( $60^\circ$ ), square ( $90^\circ$ ), and rotated square ( $45^\circ$ ).

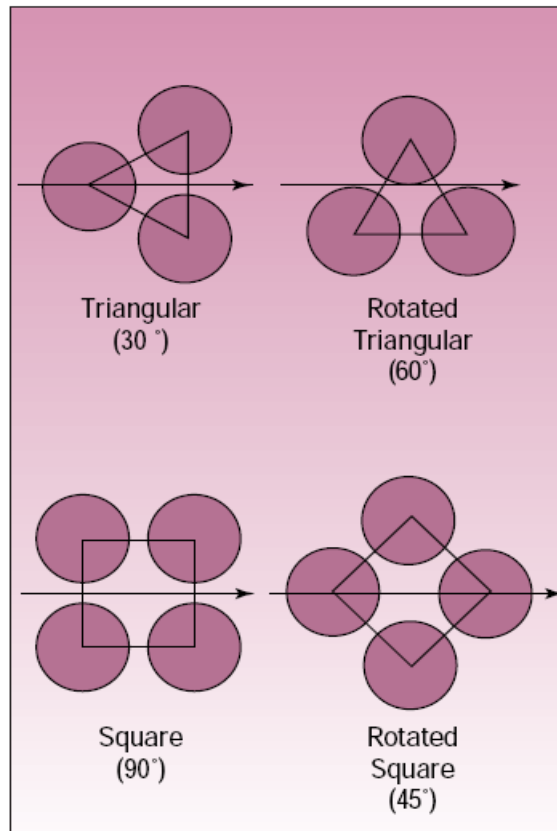

Figure 3 : Tube layout patterns [3]

A triangular (or rotated triangular) pattern will accommodate more tubes than a square (or rotated square) pattern. Furthermore, a triangular pattern produces high turbulence and therefore a high heat-transfer coefficient. However, at the typical tube pitch of 1.25 times the tube O.D., it does not permit mechanical cleaning of tubes, since access lanes are not available. Consequently, a triangular layout is limited to clean shellside services. For services that require mechanical cleaning on the shellside, square patterns must be used. Chemical cleaning does not require access lanes, so a triangular layout may be used for dirty shellside services provided chemical cleaning is suitable and effective.

For dirty shellside services, a square layout is typically employed. However, since this is an in-line pattern, it produces lower turbulence. Thus, when the shellside Reynolds

number is low ( $< 2,000$ ), it is usually advantageous to employ a rotated square pattern because this produces much higher turbulence, which results in a higher efficiency of conversion of pressure drop to heat transfer.

In addition, the tube pitch is defined as the shortest distance between two adjacent tubes. For a triangular pattern, TEMA specifies a minimum tube pitch of 1.25 times the tube O.D. Thus, a 25-mm tube pitch is usually employed for 20-mm O.D. tubes [4].

For square patterns, TEMA additionally recommends a minimum cleaning lane of 4 in. (or 6 mm) between adjacent tubes. Thus, the minimum tube pitch for square patterns is either 1.25 times the tube O.D. or the tube O.D. plus 6 mm, whichever is larger. For example, 20-mm tubes should be laid on a 26-mm (20 mm + 6 mm) square pitch, but 25-mm tubes should be laid on a 31.25-mm square pitch.

Designers prefer to employ the minimum recommended tube pitch, because it leads to the smallest shell diameter for a given number of tubes. However, in exceptional circumstances, the tube pitch may be increased to a higher value, for example, to reduce shellside pressure drop. This is particularly true in the case of a cross-flow shell.

While discussing about baffle, baffles are used to support tubes, enable a desirable velocity to be maintained for the shellside fluid, and prevent failure of tubes due to flow-induced vibration. There are two types of baffles: plate and rod. Plate baffles may be single-segmental, double-segmental, or triple-segmental, as shown in Figure 4.

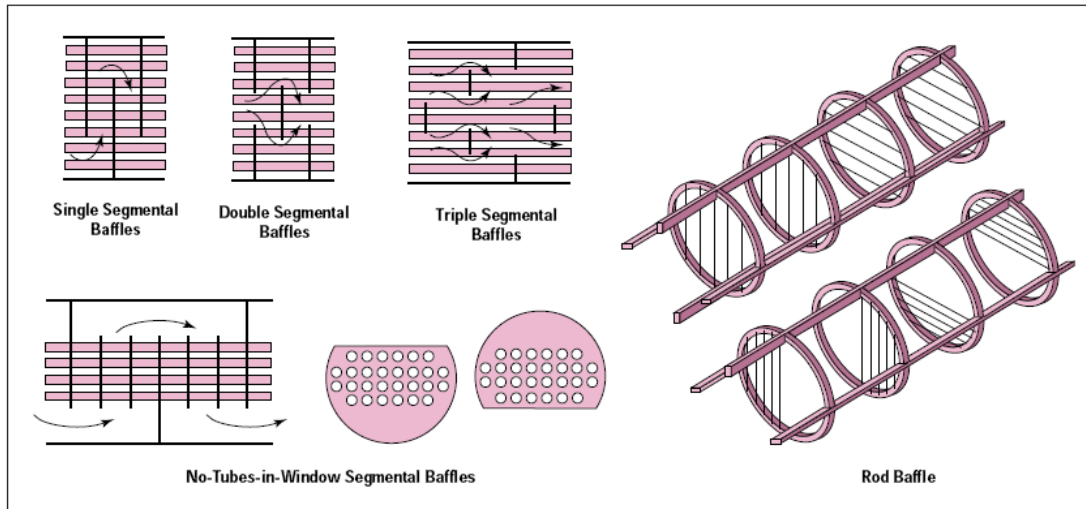

Figure 4 : Types of baffles [3].

Baffle spacing is the centerline-to-centerline distance between adjacent baffles. It is the most vital parameter in STHE design.

The TEMA standards specify the minimum baffle spacing as one-fifth of the shell inside diameter or 2 in., whichever is greater. Closer spacing will result in poor bundle penetration by the shellside fluid and difficulty in mechanically cleaning the outsides of the tubes. Furthermore, a low baffle spacing results in a poor stream distribution as will be explained later.

The maximum baffle spacing is the shell inside diameter. Higher baffle spacing will lead to predominantly longitudinal flow, which is less efficient than cross-flow, and large unsupported tube spans, which will make the exchanger prone to tube failure due to flow-induced vibration.

### 2.3 Corrosion

There are various types of corrosions on carbon steel including atmospheric corrosion, aqueous corrosion, soil corrosion, boiler service corrosion and liquid metal corrosion. Each type has its own specific condition and behavior.

Atmospheric corrosion attacks material in certain types of condition such as marine environment, rain, fog, dusts and temperature environment. Normally, corrodants

involve for these whole environment are specific element such as  $\text{SO}_x$ ,  $\text{NO}_x$ , Cl,  $\text{O}_2$  and Hydrogen Sulfide elements.

Marine condition corrosion is subjected to chloride attack resulting from the deposition of fine droplet or crystals formed by evaporation of spray that been carried by wind from the sea. The nearer the equipment are to the shore, the deposition and corrosive effects are greater.

In rainy conditions the corrosion rate is increased as the rain washed the corrosion promoter, such as  $\text{H}^-$  &  $\text{SO}_4^-$  from the air. Fogs normally form in high acidity and concentration sulfate and nitrate which reduce the pH to between 2.2 and 4.0. As the acidity is increased, corrosivity also increases.

Dust come in contact with metallic surfaces and then combines with moisture in the air. Afterwards it forms galvanic cell at differential aeration cells and result in an electrolyte on the surface. Dust which is soluble with water or an absorber of sulfuric acid consequently caused corrosion faster and easier.

There are specific elements which plays role as corrodant in causing corrosion on carbon steel in atmospheric condition. Elements such  $\text{O}_x$ ,  $\text{NO}_x$ , Cl,  $\text{O}_2$  and Hydrogen Sulfide have its own characteristics and sources. Below are some of brief descriptions about these elements shown in Table 1.

Table 1 : Element property involve in atmospheric condition[5].

Element	Source	Characteristic
SO <sub>x</sub>	<ul style="list-style-type: none"> <li>Burning of fossil, coals &amp; oil</li> </ul>	<ul style="list-style-type: none"> <li>SO<sub>2</sub> oxidized by water droplets which form sulfuric acid and highly concentrated. Compound deposition in:               <ol style="list-style-type: none"> <li>Dry – absorption on metal surface, impaction of particles</li> <li>Wet – precipitate in form of rain or fog</li> </ol> </li> </ul>
NO <sub>x</sub>	<ul style="list-style-type: none"> <li>Forms from energy production and road traffic</li> </ul>	<ul style="list-style-type: none"> <li>Combustion → emitted → NO → oxidized → NO<sub>2</sub> → oxidized → HNO<sub>3</sub></li> <li>NO<sub>2</sub> increased, concentration increased, corrosion effect faster.</li> </ul>
Chloride	<ul style="list-style-type: none"> <li>In form of droplet or crystals by evaporation of spray sea water</li> <li>Emission of gaseous HCl from coal burning &amp; municipal incinerator</li> </ul>	<ul style="list-style-type: none"> <li>Deposition decrease when distance increase from shore, filtered by through vegetation and gravity</li> <li>HCl soluble in water and form hydrochloric acid which is extremely corrosive.</li> </ul>
Oxygen	<ul style="list-style-type: none"> <li>Naturally from air, absorb from air to water.</li> </ul>	<ul style="list-style-type: none"> <li>Cause water film on metal surface, saturated compound will enhance oxidation reaction</li> </ul>
Hydrogen Sulfide	<ul style="list-style-type: none"> <li>Found in some contaminated atmosphere.</li> </ul>	<ul style="list-style-type: none"> <li>Cause tarnishing of silver and copper by formation of tarnish film</li> </ul>

Aqueous corrosion is due to the environment or surrounding conditions or is based on chemical compounds. Environmental conditions may involved river condition, seawater environments and situations occupied with processing and transferring of water.

In marine corrosion, factors that play role are consistency and the major ions composition, variability and effect of minor ions, effects of surrounding pollutant, and influence by biological organism.

Factor of consistency and major ions involved is evaluated according to the salinity and chlorinity of water profile. Salinity is usually determined by measuring either the chlorinity or the electrical conductivity of the seawater while chlorinity, Cl, is defined as the mass in gram of silver required to precipitate the halogen in 0.3285234 kg of seawater.

Table 2: Ions and major molecules in seawater and river water

Ions and molecules in seawater of 35% salinity		Ions and molecules in average river water	
Na <sup>+</sup>	Br <sup>-</sup>	Na <sup>+</sup>	HCO <sup>3-</sup>
K <sup>+</sup>	F <sup>-</sup>	K <sup>+</sup>	SO <sub>4</sub> <sup>2-</sup>
Mg <sup>2+</sup>	HCO <sup>3-</sup>	Mg <sup>2+</sup>	NO <sup>3-</sup>
Ca <sup>2+</sup>	SO <sub>4</sub> <sup>2-</sup>	Ca <sup>2+</sup>	Fe <sup>2+</sup>
Cl <sup>-</sup>	B(OH) <sub>3</sub>	Cl <sup>-</sup>	Si(OH) <sub>4</sub>

Table 3: Additional factors in marine condition corrosion [5].

<b>Variability and effect of minor ion</b>	<b>Effect of pollutant</b>	<b>Influence of biological organism</b>
<p>Dissolved oxygen</p> <ul style="list-style-type: none"> <li>• Influenced by air-sea exchange as well as by biochemical process</li> <li>• During high growth periods, intense photosynthesis can produce concentration as high as 200% saturation for period of up to a few week</li> <li>• Supersaturating oxygen forms and often found near-shore area.</li> </ul>	<p>Related to dissolved oxygen</p> <ul style="list-style-type: none"> <li>• Contain organic material</li> <li>• Organic material oxidized, oxygen concentration fall, carbon dioxide concentration increase, water become more acidic</li> </ul>	<p>Bacterial film</p> <ul style="list-style-type: none"> <li>• Colonization of bacteria on metal surface will from organic film.</li> <li>• Common chemical species, oxygen and hydrogen are important in metabolism of the bacteria. So they can be either source or sink for either oxygen or hydrogen. Provide spotty coverage on the surface and capable of inducing concentrated oxygen cells which will cause corrosion.</li> </ul>
<p>Dissolved carbon dioxide &amp; pH</p> <ul style="list-style-type: none"> <li>• Produced by photosynthesis activities</li> <li>• Presence of bicarbonate and carbonate ions.</li> <li>• Accelerate corrosion especially on aluminum</li> </ul>	<p>Sulfide</p> <ul style="list-style-type: none"> <li>• Form sulfide films on metal surface, which will continuously accelerate pitting corrosion.</li> </ul> <p>Heavy metal</p> <ul style="list-style-type: none"> <li>• Normally unpolluted seawater contains nearly very known element, normally in small concentration</li> <li>• Pollution increase concentration some element and accelerate corrosion.</li> </ul>	<p>Macrofouling films</p> <ul style="list-style-type: none"> <li>• Colonized by macrofouling organism after being colonized by bacteria</li> <li>• Weight and hydrodynamic drag will increased by fouling layer</li> <li>• May induce oxygen or chemical concentration cell, which leads to various types of localized corrosion.</li> </ul>



## CHAPTER 3

### METHODOLOGY

Failure analysis methods were utilized in this project. Several testing and examinations steps used were suitable for examining the tubes. The failure analysis methods are used summarized in Figure 5.

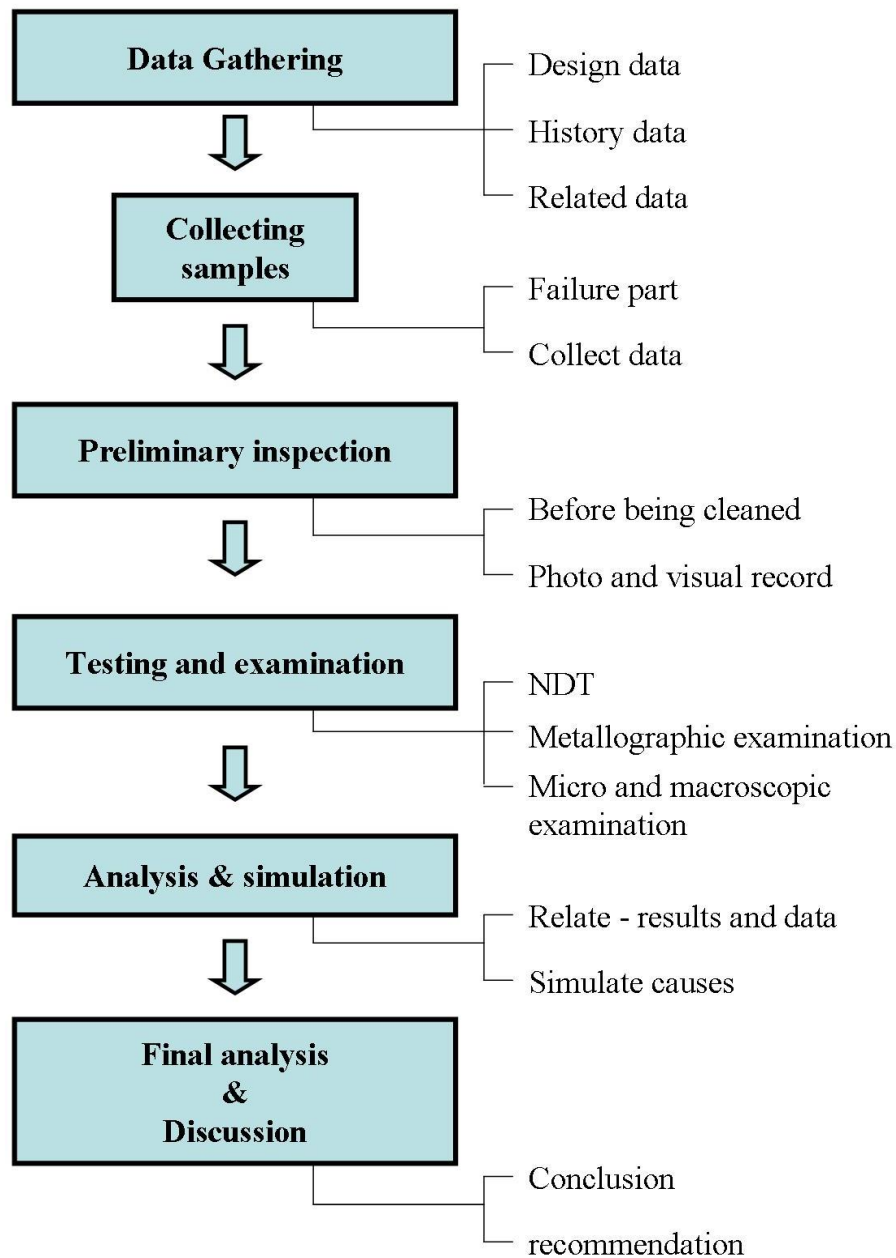

Figure 5 : Flow chart of methods used

### **3.1 Data Gathering**

At the beginning of the project, author has been collecting design and history data of the heat exchanger especially for the tube bundles. Related information gathered with assistance of respective personnel at GPP Kerteh. Design data collected consist of drawing design and characteristic of medium operated inside the heat exchanger (T-831). History data includes maintenance activities data and non-destructive examination (NDE) result data.

### **3.2 Collecting Sample**

Also in the same time at GPP Kerteh, author has picked out two rods of the heat exchanger's tubes. These two parts consist of an attachment part which connected onto the heat exchanger head and the middle part of the tubes bundle.

### **3.3 Preliminary inspection**

Before any cleaning or testing performed on the sample, preliminary inspection has been done onto the tubes. Photographs were captured in various angle of view. Physical conditions which could be seen by naked eye were also noted.

### **3.4 Testing and Examination**

Testing including nondestructive testing, metallographic examination, microscopic and macroscopic observation has been carried out. All this testing executed along week 4 till week 7 in the second semester as planned earlier. Equipment such as abrasive cutter, Real-time Micro-focus X-ray machine, Energy Dispersive Spectroscopy (EDS) and scanning electron microscope (SEM) were used. The failed part on the tubes been marked by respective plant personnel earlier. The tubes were divided into smaller parts by using abrasive cutter in order to mount and examine it in various machines.

#### **3.4.1 Non-destructive Testing (NDT)**

All this testing executed along week 4 until week 8 in the second semester as planned. Next is the non-destructing testing (NDT) which exposed the internal features of sample. Because of the tubes condition which has fins around the external surface, testing such as dye penetrant testing and magnetic particle inspection can not be done

properly. As the result, non-destructive x-ray testing performed and supervised by respective technician using real-time micro-focus X-ray machine. This test will reveal internal conditions of the sample if any differences in surface thicknesses occur. Thicker surface will result in brighter spot and vice versa.



Figure 6 : Abrasive cutter

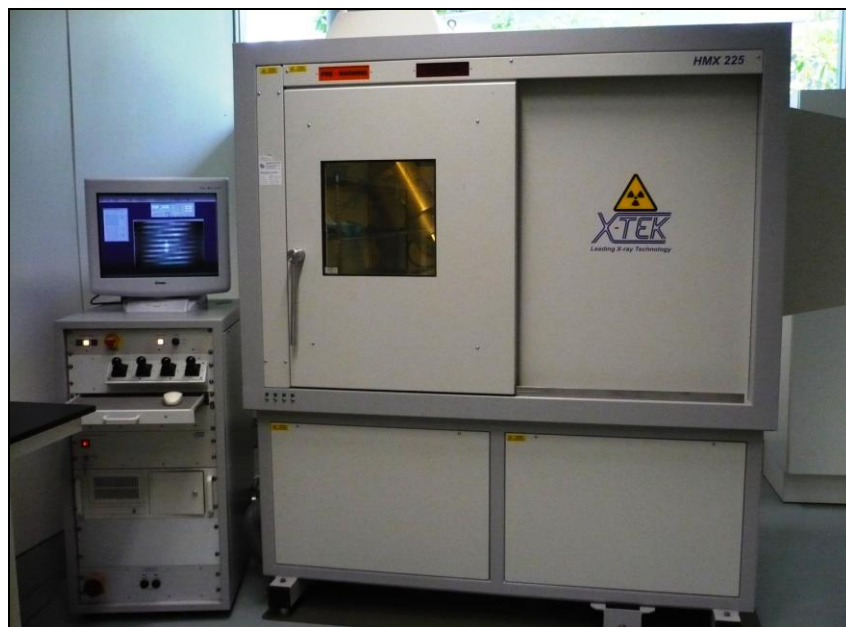

Figure 7 : Real-time Micro-focus X-ray machine

### 3.4.2 Metallographic Examination

Other cross-section parts mounted to make it easy to be handled by using automatic mounting machine. The microscopic examinations need to be done only after the sample preparations. The sample preparation steps are as the follows.

- Mounting process done for the sample using hot mounting technique (automatic mounting machine). Bakelite was used to form the mounted part.
- Grinding sample using abrasive paper or SiC papers. By assistance from technician, grinding started from paper number 120, 320, 400, 600, 800, 1200. The highest is the finest grade.
- Polishing process using diamond water paste starting from 6 $\mu$  and finally polishing using 1, 0.25 diamond.
- Etching done after the polishing process. This carbon steel sample etched using Nital solution. The sample quickly rinsed with water and then alcohol followed drying using dryer.



Figure 8 : Automatic mounting machine

The etched sample examined under a metallurgical microscope up to 100x magnifications. The generated microstructure images captured and analyzed as to recognize the material structure.

### **3.4.3 Micro and Macroscopic Examination**

Three specimens coated with a thin layer (about 20nm) of vacuum deposited gold to improve their conductivity. Specimens being coated for about 1 hour whereas larger the volume of sample, the duration would be increased. Conductive coated replicas examined with both EDX and SEM.



Figure 9 : Scanning Electron Microscopy

### **3.5 Final analysis, Conclusion and Discussion**

Finally, a report will be completed. All findings, results and discussions are included and final verification will be done with implementing comments and suggestions from author's superiors, examiners and experienced personnel.

**Milestone for the Second Semester for this project**

No.	Detail/ Week	1	2	3	4	5	6	7	8	9	10	11	12	13	14	
1	Collecting Preliminary Data										<b>Mid-Semester Break</b>					
2	Submission of Progress Report 1															
3	Experiment and Testing															
4	Submission of Progress Report 2															
5	Seminar															
5	Analysis and brainstorming result & conclusion															
6	Poster Exhibition															
7	Submission of Dissertation (soft bound)															
8	Oral Presentation															
9	Submission of Project Dissertation (Hard Bound)															

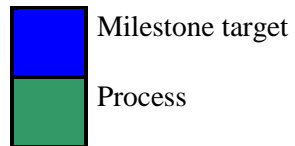

Figure 10: Gantt-chart of thesis planning

## CHAPTER 4

### RESULTS AND DISCUSSIONS

#### 4.1 Summary of Background Data

As the beginning of project, data has been collected for the tube bundles of this heat exchanger (T-831). Engineering drawings, maintenance schedules, inspection reports and operation parameters were obtained from the plant

Labeled as Water Cooled Refrigerant Condenser, heat exchanger T-831 is a fixed-tubesheet heat exchanger. It encountered shutdown activities similar to other equipment in GPP. Some data of the heat exchanger are as follows:

Heat Exchanger : Water Cooled Refrigerant Condenser (T-831)

Material : A 214 (carbon steel) – tube part

No. tubes in unit : 4178

Tube Dimension : 0.750” O.D, 0.083” Wall.

Tube length : 30 ft.

Design Pressure : 300 kPa/G

Design Temperature : 20/60 °C

Service and maintenance (shutdown) :

- Plant turnaround – every 3 years operation
- DOSH requirement - every year
  - reregister pressure vessel
  - renew Certificate of Fitness (CF)

Water cooled Refrigerant Condenser, T-831 was used to condense propane vapor from the gas engine compressor discharge R-806 for unit 3 Refrigeration System of Export Terminal. The heat exchanger uses cooling water from Export Terminal 2 (ET2) Cooling Tower for its cooling medium. The cooling water passes through tube side and propane vapor passes through the shell side.

The propane vapor inlet pressure of the shell side of T-831 is between 12 and 14 bar/G and temperature between 65 and 75 °C. While the pressure and temperature of propane outlet of the shell side was between 12 and 14 bar/G and temperature was between 30 and 35 °C respectively. The cooling water inlet pressure of the tube side of T-831 was about 45 bar/G and temperature of between 27 and 29 °C. Expected temperature of cooling water outlet of the tube side was between 30 and 32 °C.

Based on historical data gathered, issues of concerns can be listed as:

- Contaminated cooling water.
- Passivation process not executed properly before startup.

The drawing of the T-831 heat exchanger and the respective plant circuit are shown in the Figure 11 and Figure 12 respectively.



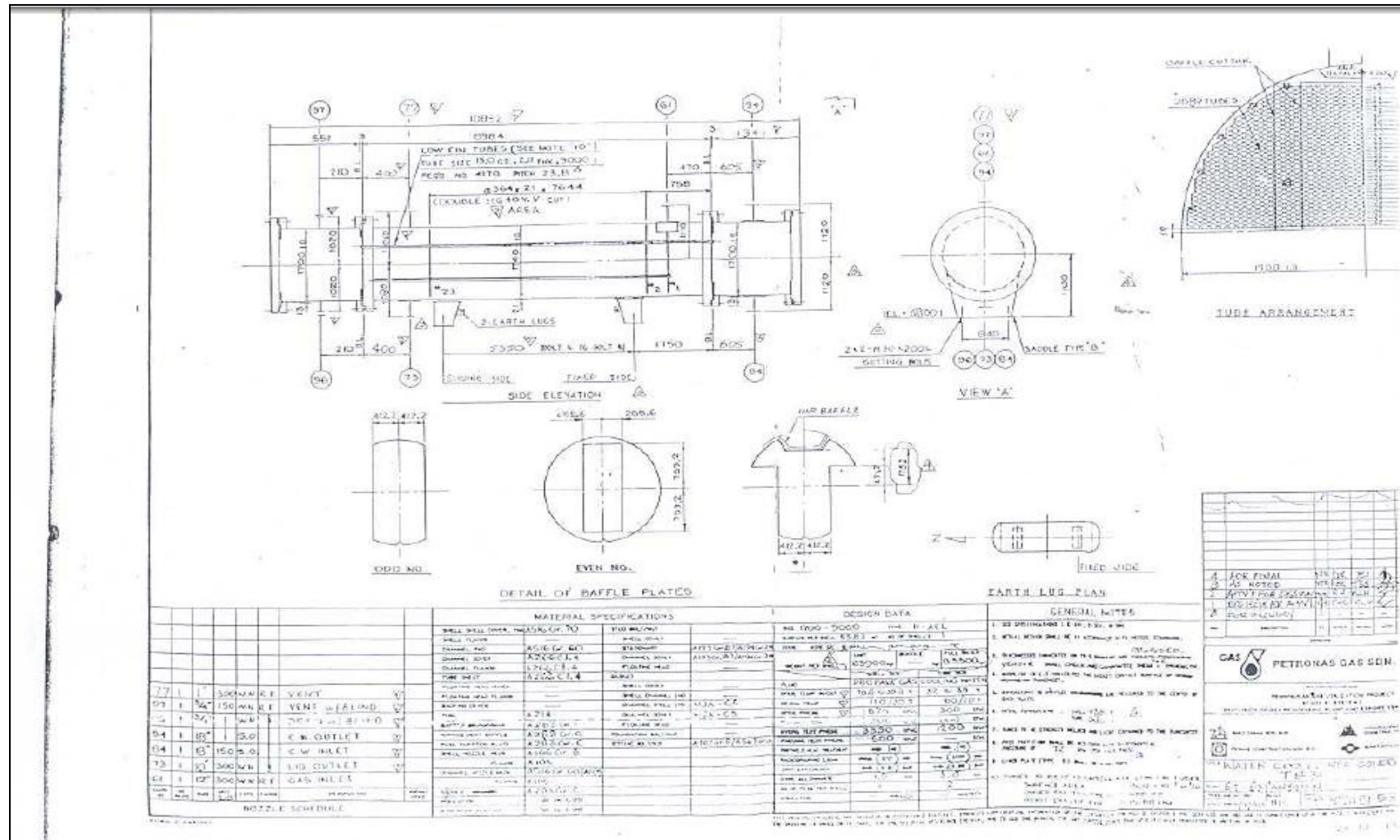

Figure 11 : One of the drawing designs for T

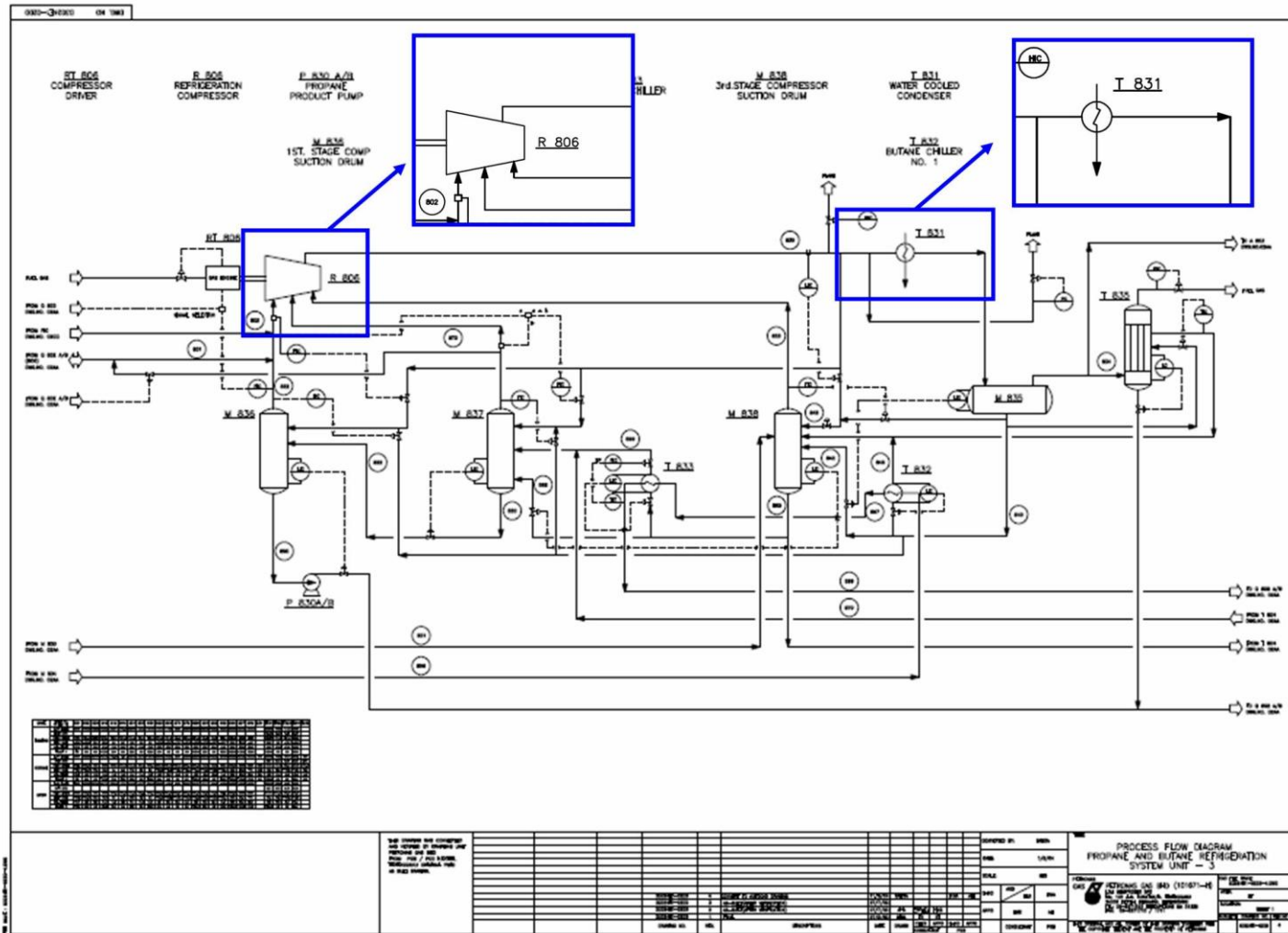

Figure 12 : Plant Circuit for T-831

## 4.2 Sample Collection

During the semester break of January 2008 semester, samples were obtained from GPP in Kerteh. Samples were stored in the Inspection Section office at GPP Kerteh. All the tubes were in highly corroded condition and two samples with white marking indicating failed regions were obtained. Author also performed snoop leak test on to the selected tubes, and no leakage was found. The two samples obtained are shown in Figure 14 and Figure 15.



Figure 13 : Tubes sample stored at Inspection Section, GPP Kerteh

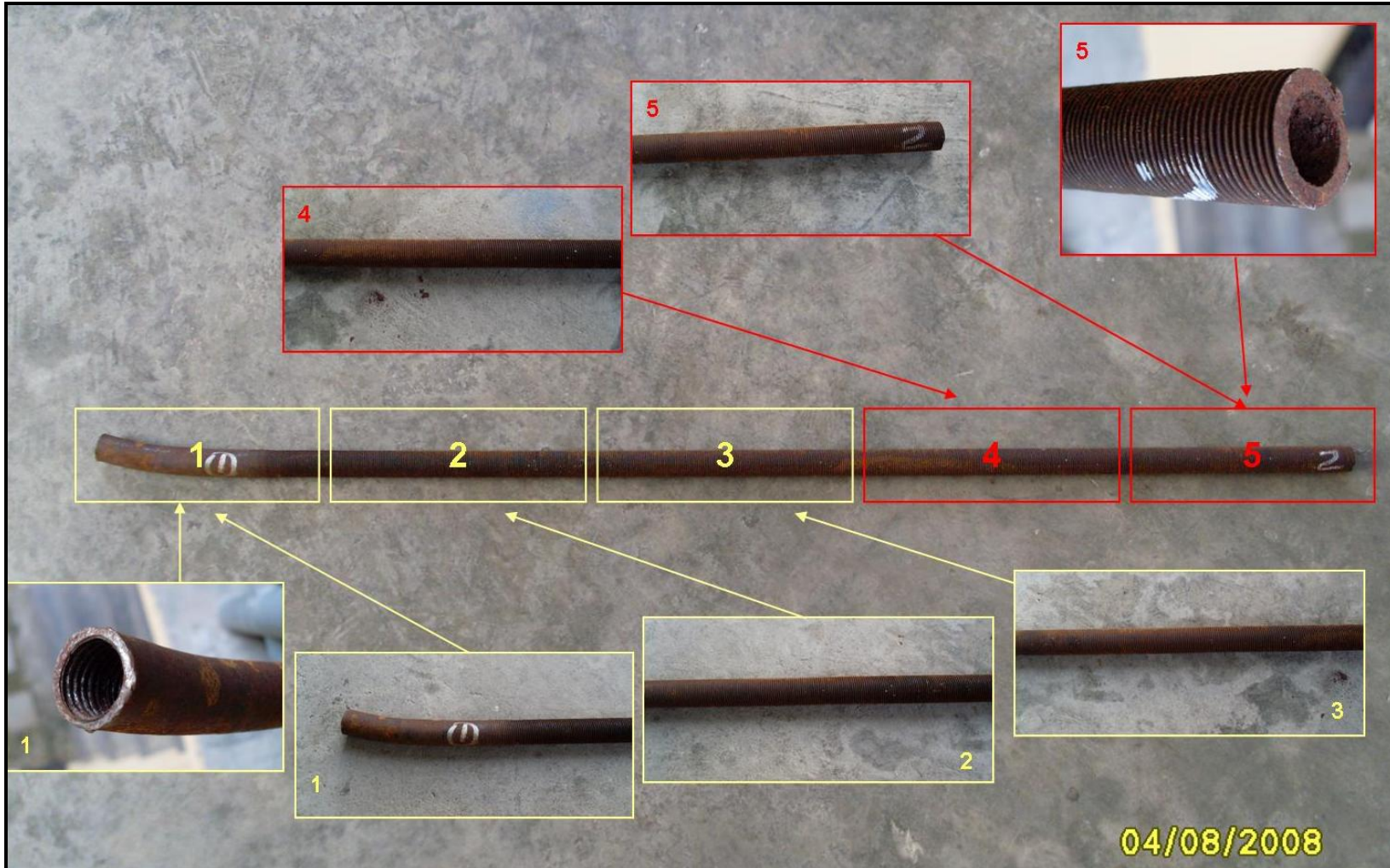

Figure 14 : Tube sample A

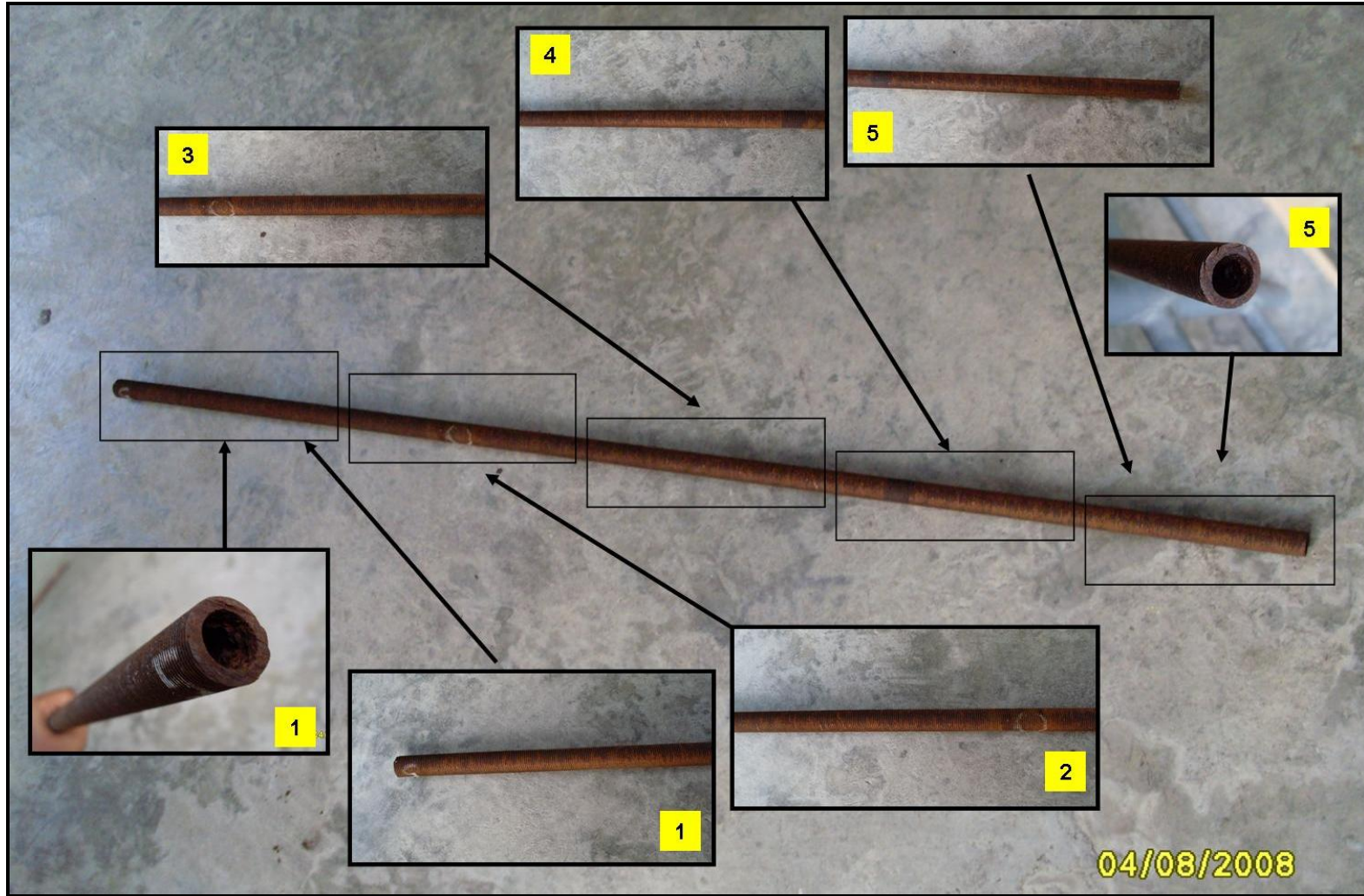

Figure 15 : TUBE B

### 4.3 Heat Exchanger T-831

Heat exchanger T-831 is located at Export Terminal (ET) GPP Kerteh and is used for temperature control of propane at the terminal. In addition, author also had collected some opinions and suggestions regarding the heat exchanger from several inspection and maintenance personnel.

Below are some of the assessments noted by author at GPP Kerteh:

Possible causes of failure
<ul style="list-style-type: none"><li>• Lack of monitoring GPP personnel during fabricating equipment.</li><li>• Cooling tower water quality not meeting requirement.</li><li>• Heat exchanger design not incorporating newer materials.</li><li>• Material used is not corrosion resistant.</li></ul>
Suggested prevention methods
<ul style="list-style-type: none"><li>• Fully monitor equipment during fabrication.</li><li>• Improve cooling tower water quality and monitor properly.</li><li>• Improve material selection for heat exchanger design.</li><li>• Improve passivation process before startup.</li></ul>

### 4.4 Non- destructive Examination

Before performing NDT, the samples were cut into shorter pieces and the rust on the surface were removed. Tube A was cut into five parts as shown previously in the Figure 12. Parts A-2 and A-4 were selected for NDE. Sample A-2 was selected because videoscope examination reveals excessive corrosion of the location. Sample A-4 show acceptable condition of the heat exchanger tubes.

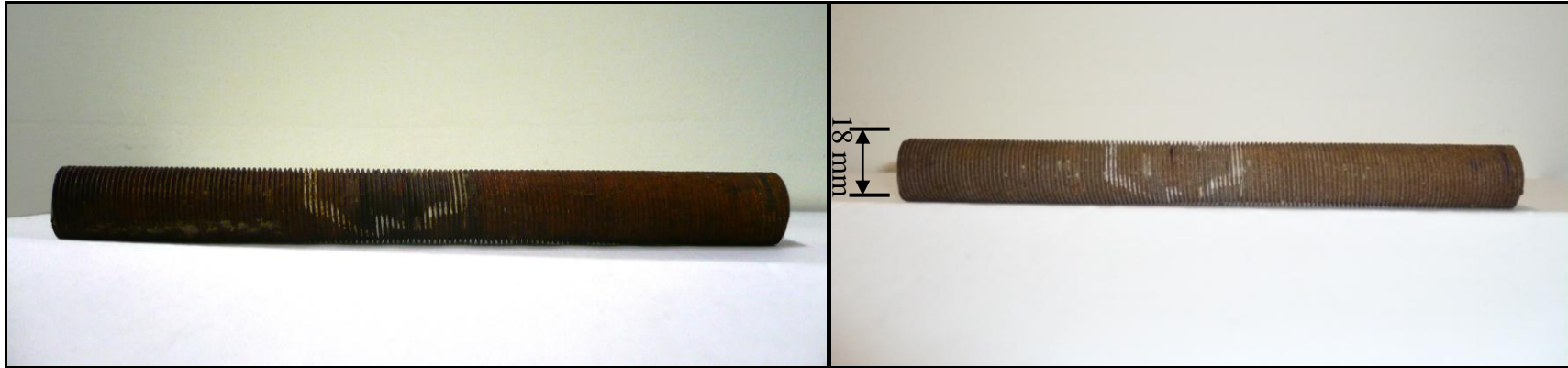

Figure 16 : A2 part before and after rust removal

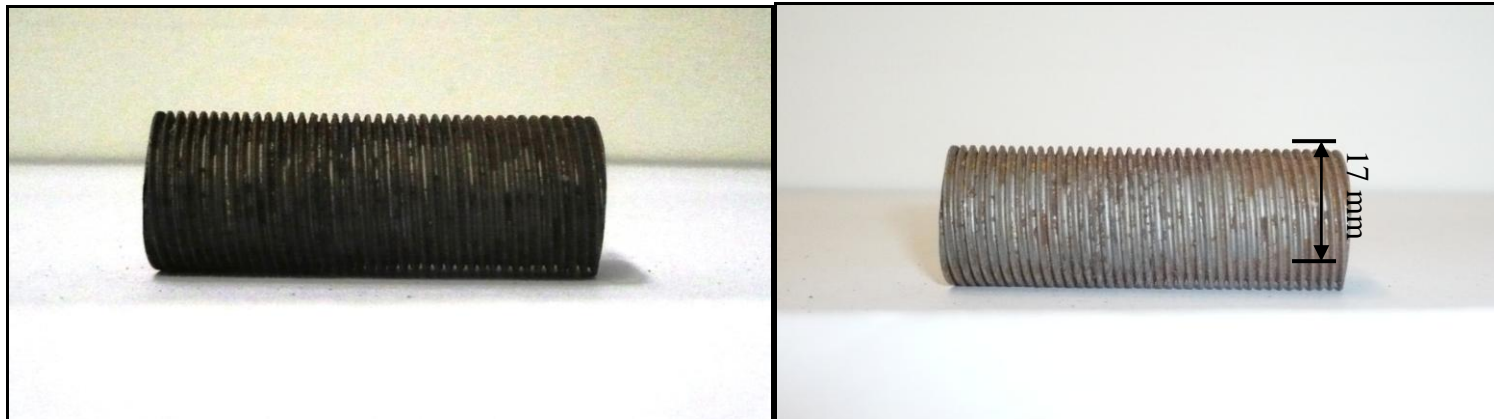

Figure 17 : Before and after rust removed of A4 part

Real-time X-ray testing has been done by using Real-time Micro-focus X-ray machine and the results obtained are shown in Figures 18 and 19.

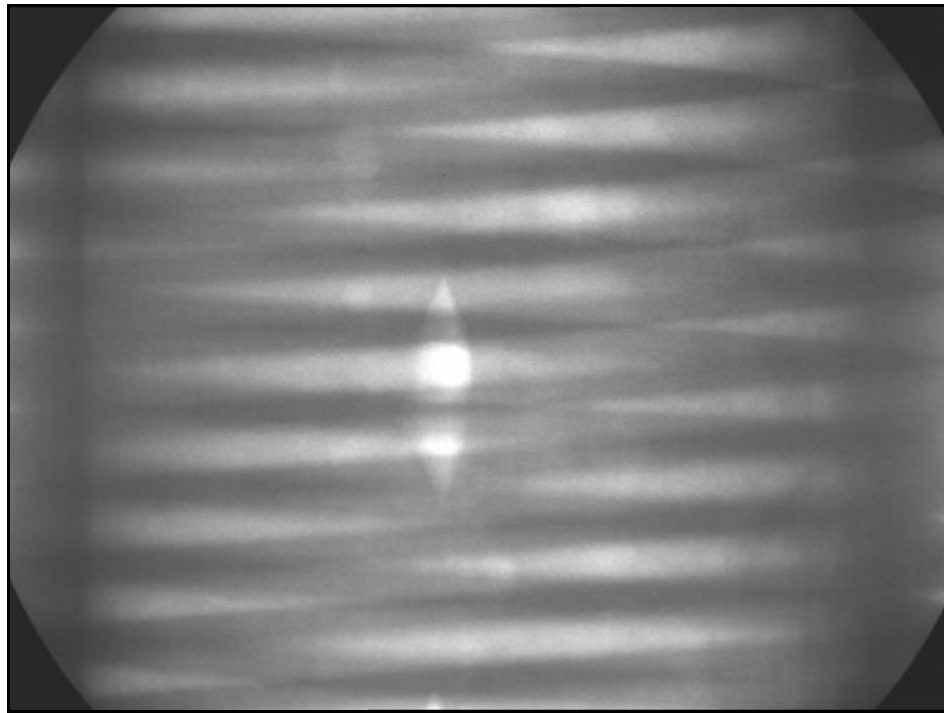

Figure 18 : A bright spot revealed. (Part A-2)

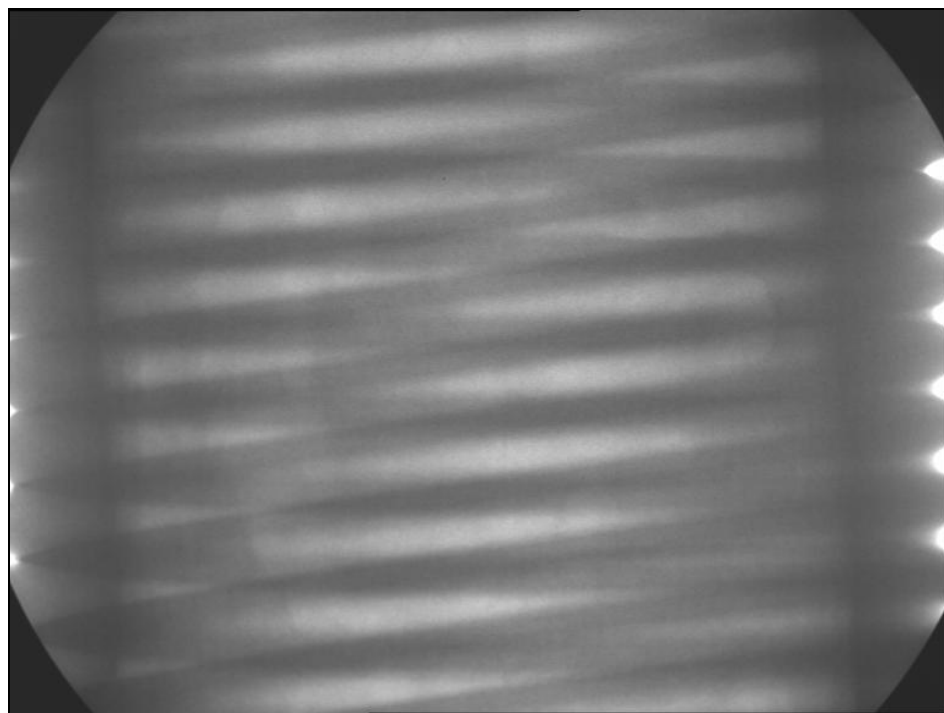

Figure 19 : Part A-4 found having good condition with less wall loss incident.



The X-ray examination revealed an elliptical pit in the tube. The elliptical pit is normally seen in failure of pressurize component which the shape propagation start at the middle shape and further increased at the edges of the shape.

#### 4.5 Metallographic and Fractography Examinations

For metallographic and fractography examination, the sample studied are shown in Figures 20, 21 and 22. The sample in Figure 20 is a cross section of tube A. the sample in Figure 21 is obtain from tube B. these two samples were mounted, grinded, polished, arched and examined using the proper equipment. Another sample from A2, Figure 22 was also obtained for fractography examinations. Three main samples used for these examinations consist of the following:



- A crossed-section from tube A been taken.
- Green color mount used.
- Used in metallographic examination
- Been grinded, polished and etched.

Figure 20: Mounted sample from tube A



- Part of tube B
- Mounted in blank color mount.
- Tested as same as sample above.

Figure 21: mounted sample of tube B

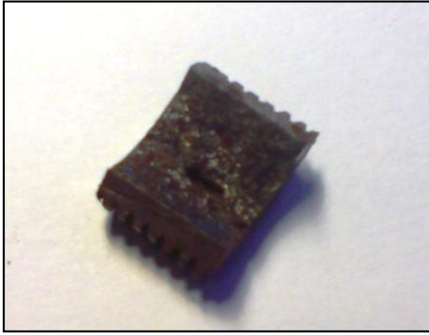

- A corrode section from A-2 part revealed by X-ray testing.
- Coated and tested by EDX and SEM machine.

Figure 22 : Sample of failed part

Below are some of the metallographic results of the samples with 20X and 50X magnification:

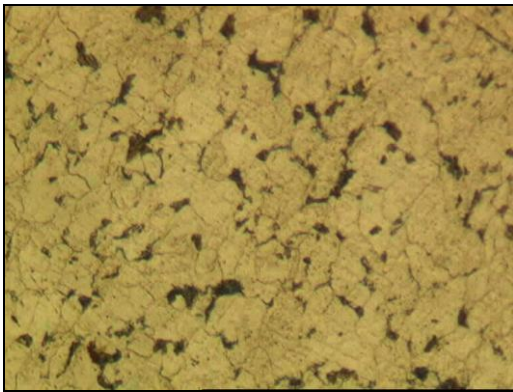

Figure 23: Sample A-20X

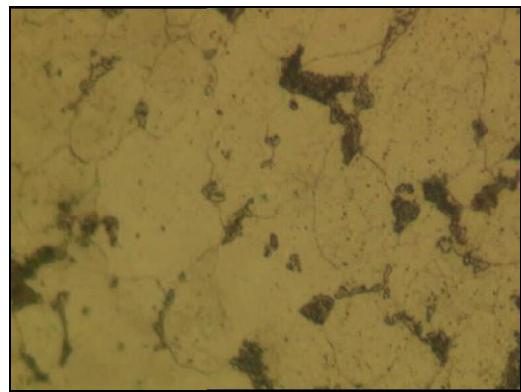

Figure 24: Sample A-50X

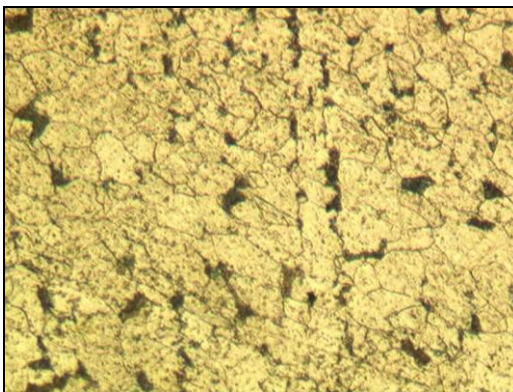

Figure 25: Sample B-20X

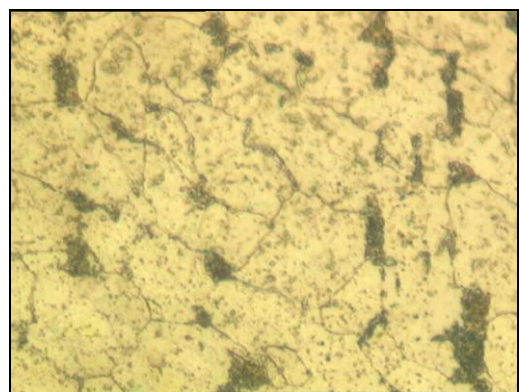

Figure 26: Sample B-50X

Presences of pearlites (dark region) in the presence of ferrite matrix show that the material is carbon steel-based material. Noted that grain boundary sample A is also look same in size and their arrangement as sample B which shown that heat treatment onto these two specimens are quite similar.

Scanning Electron Microscopic examination and Energy Disperse Spectroscopy examination have been done at the same time. The elliptical shape shown previously in the X-ray image in Figure 18 is again examined in the SEM. Figure 27 distinctly shows the elliptical shape almost 2mm in length. This pit is the reason for the tube to be out of specification because the wall thickness did not fulfill requirement.

Below are some of the results obtained:

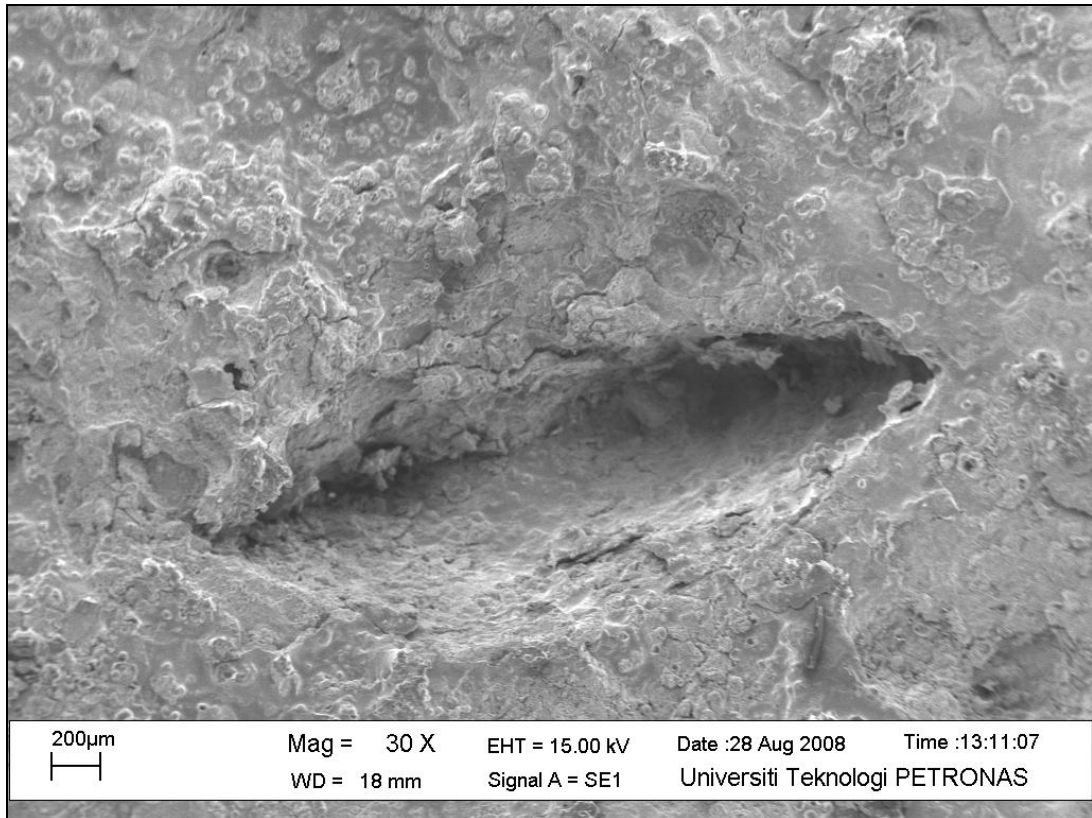

Figure 27 : Corroded part taken from part A-2

The ellipsoid shape examined showed that the pit could continue to propagate from the current condition. Darker region inside the ellipse show that these areas are deeper. There is the possibility that these areas will become a through wall rupture if operation of the tube continued.

Energy Disperse Spectroscopy (EDS) in Figures 28 and 29 also revealed that there were presences of Cl in the elliptical pit, whereas the normal sample did not contain Cl.

Project 1

5/25/2008 1:25:03 PM

Spectrum processing :  
Peak possibly omitted : 2.112 keV

Processing option : All elements  
analyzed (Normalised)  
Number of iterations = 3

Standard :  
C CaCO3 1-Jun-1999 12:00 AM  
Fe Fe 1-Jun-1999 12:00 AM

Element	Weight%	Atomic%
C K	7.16	26.39
Fe K	92.84	73.61
Totals	100.00	

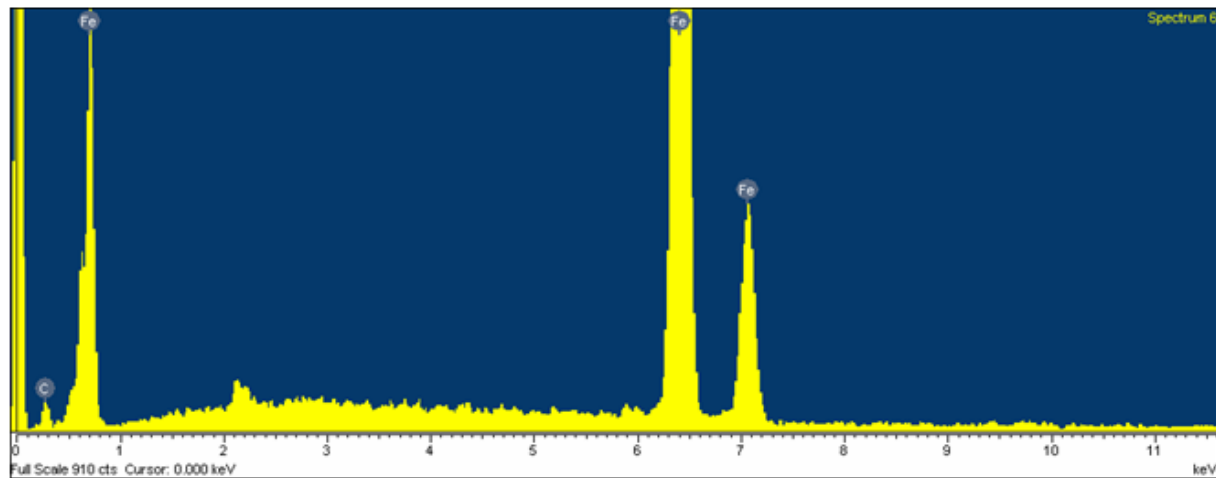

- Shown that high attendance of Fe element.
- Carbon steel was used as the tubes material

Figure 28 : result of Sample B (approximately same as Sample A)

Spectrum processing:  
No peaks omitted

Processing option: All elements analyzed (Normalised)  
Number of iterations = 5

Standard:

C CaCO3 1-Jun-1999 12:00 AM  
O SiO2 1-Jun-1999 12:00 AM  
Cl KCl 1-Jun-1999 12:00 AM  
Fe Fe 1-Jun-1999 12:00 AM

Element	Weight%	Atomic%
C K	9.17	18.32
O K	39.75	59.62
Cl K	0.48	0.32
Fe K	50.61	21.75
Totals	100.00	

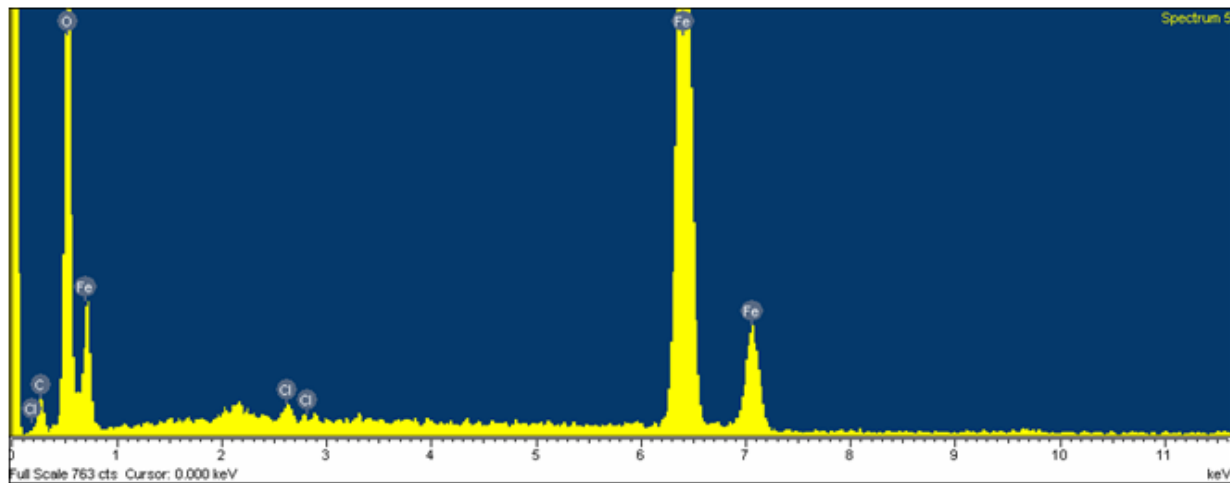

- Attendance of Cl element found on the sample surface
- Assume as one of the cause of corrosion

Figure 29 : EDX result of corroded sample

## CHAPTER 5

### CONCLUSIONS AND RECOMMENDATIONS

#### 5.1 Project Conclusions

Microstructure of the tubes indicated that the material conformed as one of carbon steel material, A 214 material specification.

Metallographic examination of the tubes material testify that no evidence of tubes being overheated, or having metallurgical deficiency. Local through-wall pitting attacks or any cracks were also not observed. From the EDS analysis, the presence of Cl indicated corrosion on the internal surface of tube.

Physically, no through wall rupture was detected. An elliptical pit was observed on the internal surface of the tube. This pit initiate as a result of a corrosion cell produced when shielding of the surfaces occurred. External regions outside the shield became cathodic and caused metal to dissolution there, at the same time within the shield, and vice versa outside the shield. An anodic reaction occurred in which a net positive charge is accumulated and attracted negatively charged ions dissolved in the water. Any anions such as sulphate spontaneously concentrate beneath the deposit. They became damaging by forming sulphuric acid via hydrolysis.



When acidic condition occurs internally, it leads to localize metal loss namely as pits. Once initiated, it normally would continue to grow by self-sustaining or by automatic catalytic process. As the result, it penetrates the tube wall until final fracture or through wall leak happened.

In addition, with respect to the history data collected, there would be side factors such as degradation of passive layer on the tubes and presence of foreign objects inside the tubes. The passive layer could prevents corrosive condition attacking carbon steel while presence of contamination inside the tubes definitely will disturb the smoothness of liquid flow, causing turbulence flow. As the disturbance of flow occurs, it will motivate pit to propagate.

## **5.2 Project Recommendations**

From the conclusions, the main cause of the heat exchanger failure is corrosion in the form of pitting. As the solution, based of the provided data, material selection in fabricating the tubes should be improved. Improved materials should be used in the manufacturing of the components.

### **5.2.1 Stainless Steel.**

Stainless steel is a well known material to encounter corrosion problem. Stainless steels in the series of AISI 300 is a little costlier than carbon steel but still within the reasonable price. In addition, this AISI 300 series steels are also capable in high-temperature applications and they also resistant to creep and oxidation. If the focus is to confront corrosion and lowering the cost investment, this group of stainless steel is acceptable. This material thermal conductivity is quite low while high thermal coefficients of expansion make this material unfavorably used.

Another suggested type of stainless steel is superduplex stainless steel. Their moderate ability in pitting corrosion and stress corrosion cracking resistance make them very useful in many applications. The fabricating cost which need control is welding in order to avoid the heat affected zone being degraded making the fabrication more expensive.

### **5.2.2 Nickel Alloy**

Briefly, nickel alloys are good in resisting wet corrosion especially to reduce acid, neutral salt solutions and alkalies. By increasing the content of nickel in austenitic alloy, it also will improve resistance from stress-corrosion cracking failure. It is the most useful stabiliser in austenitic structure while addition of molybdenum in alloying the metal. Molybdenum is expensive but effectively can increase mechanical properties of material and the strength both at ambient and high temperature. An alternative to achieve desired property of material, both in encounter corrosion failure and high cost of fabrication by composing 20% of nickel content in the material.

### **5.2.3 Passivation**

If the equipment has been shut down, there should be a proper task in producing the passive layer onto the tubes bundle at each time assembling activity is done. This layer is very importance in order to make sure the tubes are properly protected during operation.

### **5.3 Recommendation of Future Work**

As reported, this thesis performed the analysis of failure on the heat exchanger tubes in GPP. To further confirm the recommendation, future studies can be performed as follows:

- Study of the heat exchanger design by using real model,
- Design and fabricate the equipment using various fabrications method to study their effects,
- Investigation of equatorial environmental effects into the equipment operations.



## REFERENCES

- [1]. "Failure Analysis and Non-Destructive Examination," *FANDE lecture note*, Dr. Azmi Abdul Wahab, class on January 2008 semester (2008).
- [2]. ASM Handbook<sup>®</sup> Volume 11, "Failure Analysis and Prevention," (page 395-415).
- [3]. Effectively Design Shell-and-Tube Heat Exchangers. Rajiv Mukherjee, Engineers India ltd. February 1998.
- Mukherjee, R., "Don't Let Baffling Baffle You," *Chem. Eng. Progress*, **92** (4), pp. 72–79 (Apr. 1996).
- Mukherjee, R., "Use Double-Segmental Baffles in Shell-and-Tube Heat Exchangers," *Chem. Eng. Progress*, **88** (11), pp. 47–52 (Nov. 1992).
- [4]. Tubular Exchanger Manufacturers Association, "Standards of the Tubular Exchanger Manufacturers Association," 7th ed., *TEMA*, New York (1988).
- [5]. Metal Handbook Volume 13, Corrosion, formally 9<sup>th</sup> edition.
- [6]. Heat Exchanger Design Handbook 2002.
- [7]. Mohamad Zaid Muda, Team Leader Plant inspector of Inspection Section, GPP Kerteh, Kerteh, Terengganu. *Personal Interview*. 11<sup>th</sup> Jun 2008.
- [8]. Azman bin Md. Hashim, Plant inspector of Inspection Section, GPP Kerteh, Kerteh, Terengganu. *Personal Interview*. 12<sup>th</sup> Jun 2008.
- [9]. Intestmal Corporation Sdn Bhd, NDT and testing Company, *inspection report no V22 SEPT 2004*, ET turnaround 2004. Sept. 05, 2004.

## APPENDIX A

### Classification of heat exchanger based on construction

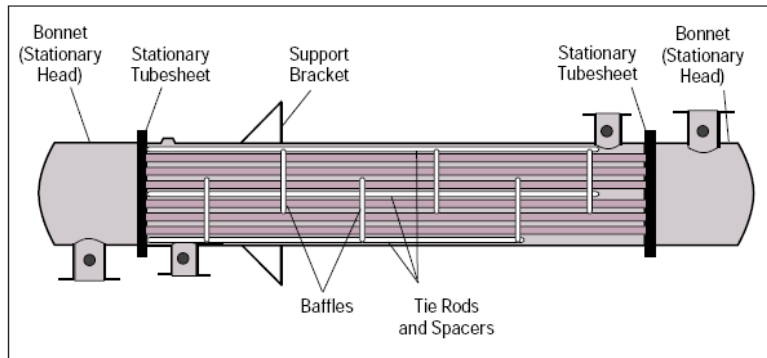

Figure A. Fixed-tubesheet heat exchanger.

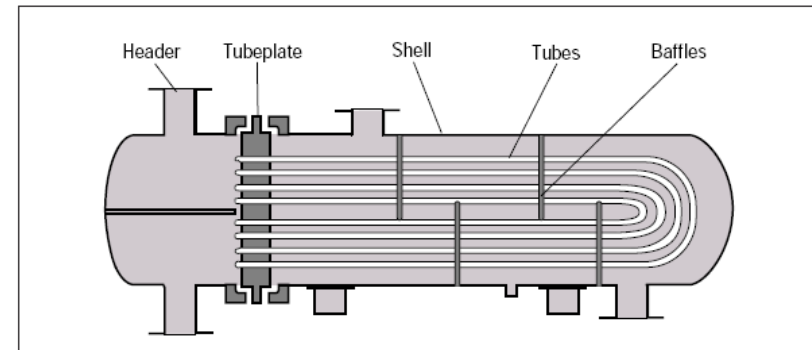

Figure B. U-tube heat exchanger.

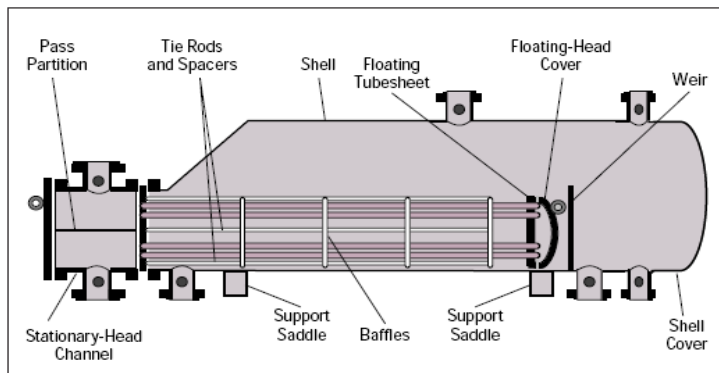

Figure C. Pull-through floating-head exchanger

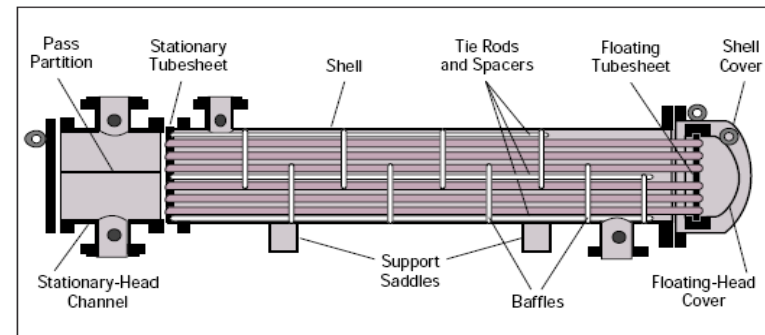

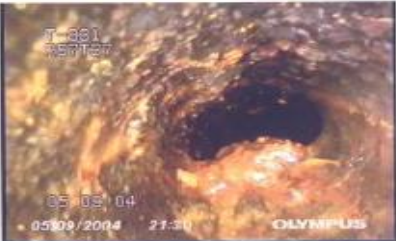

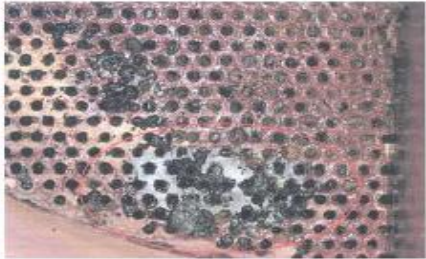



Figure D. Pull-through floating-head exchanger (TEMA T).

APPENDIX B – Inspection report

 <b>INTESTMAL CORPORATION SDN BHD</b> <small>(Co. No. 177256-A)</small>	
	
Photo Description	Photo 1 (Tube no 15 on row 14)
Finding	Deposit accumulate inside the tube
Recommendation	To be monitored
	
Photo Description	Photo 2 (Tube no 17 on row 57)
Finding	Deposit accumulate inside the tube
Recommendation	To be monitored / cleaned

		<b>PETRONAS GAS BERHAD</b>	
PLANT	EG	UNIT	3
EQUIP. NO.	T-831	PMT NO.	38753
DESCRIPTION	WATER COOLED REF. CONDENSER		
PHOTO NO	03	PHOTO DESCRIPTION	
		FINDINGS: HARD DEPOSITE FOUND AT THE TUBES SHEET AND MOST TUBES WAS FOUND CLOGGING WITH DEPOSITE.	
PHOTO NO	04	PHOTO DESCRIPTION	
		FINDINGS: TOP SIDE OF THE SOUTH SIDE PARTION PLATE WAS FOUND WITH PAINT BLISTERING AND LAYER OF DEPOSITE SCALE.	
INSPECTOR: AZMIR B. MOHAMD AMIN		REVIEWED BY: 	
DATE: 01.09.2004		DATE: 05.09.2004	

Some of previous report related on the tube of heat exchanger T-831

## APPENDIX C – Water quality sample data

123 Lotus **SMARTSuite** 1-2-3 - [D:\study\STUDY FINALE\FYP\Data\T-831\Water Quality sample\AIR2003\AIR1103]

File Edit View Create Range Sheet Window Help

A:P10

TITLE: COOLING WATER / EFFLUENT WATER ANALYSIS REPORT

DATE:	07/11/2008								
<b>ANALYTICAL PARAMETER</b>	<b>UNIT</b>	<b>MAKE UP WATER</b>		<b>EXPORT TERMINAL 1 COOLING WATER</b>		<b>EXPORT TERMINAL 2 COOLING WATER</b>		<b>EFFLUENT WATER*</b>	
		<b>SPEC</b>	<b>RESULT</b>	<b>SPEC</b>	<b>RESULT</b>	<b>SPEC</b>	<b>RESULT</b>	<b>SPEC</b>	<b>RESULT</b>
TEMPERATURE	DEG C							< 40 DEG C	
pH			7.3	7.2 - 8.5	8.1	8.0 - 8.4	7.0	5.5 - 9.0	7.3
TURBIDITY	NTU		2	30 MAX	12	15 MAX	16 MAX		
CONDUCTIVITY	Micro S/cm		42	700 - 1000	857	2000 MAX	409		
Ca HARDNESS	mg/l		15	100 - 300	40	50 - 800	75		
TOTAL HARDNESS	mg/l		17	300	51		90		
m - ALKALINITY	mg/l		9	100 - 200	43	50 - 200	22		
CHLORIDE	mg/l		11				100		
TOTAL IRON	mg/l		0.2	3 MAX	0.8	5 MAX	0.5	5 MAX	
FREE CHLORINE	mg/l		0.50	0.2 - 0.5	0.70	0.1 - 0.5	0.30	< 2	
C.O.D	mg/l							100	
SUSPENDED SOLID	mg/l							100	
OIL & GREASE	mg/l							10	
DISSOLVED SOLID	mg/l								
ZINC	mg/l					0.4 - 1.0	2.00	1 MAX	
UNFPHOSPHATE	mg/l			10 - 22	22.5	10 - 14	40.1		
FIL PHOSPHATE	mg/l			10 - 22	21.3	10 - 14	38.5		
TOTAL ZINC	mg/l						2.40		
CYCLE OF CONC				6 - 8	6	4 - 6	8		

\* Only pH is done daily  
Other analysis are done weekly

<b>CHEMICALS FEED RATE / BLOWDOWN / CORRECTIVE ACTION</b>								
<b>ET 1</b>	<b>PRESENT</b>	<b>CHANGE TO</b>	<b>REMARK</b>		<b>ET 2</b>	<b>PRESENT</b>	<b>CHANGE TO</b>	<b>REMARK</b>
NaOCl	18				NaOCl	10		
DN 2760	2			READING	NaOH	0	5	
PY 5204	5			IN	9674	3		READING
NX 1106				ML/MIN	5242	1	STOP	8hrs/Day
					23268	0		Stockout
					7330	0		
BLOWDOWN	0			PERCENT	BLOWDOWN	10	maintain	PERCENT

ANALYSED BY : MNMN VERIFIED BY IBM

ATTACHMENT NO : ET0-WP-05/F05 REVISIONS NO : 0 DATE : 18/05/2002

PAGE 1 OF 1 TITLE: COOLING WATER / EFFLUENT WATER ANALYSIS

Cooling water specification in 123 format data

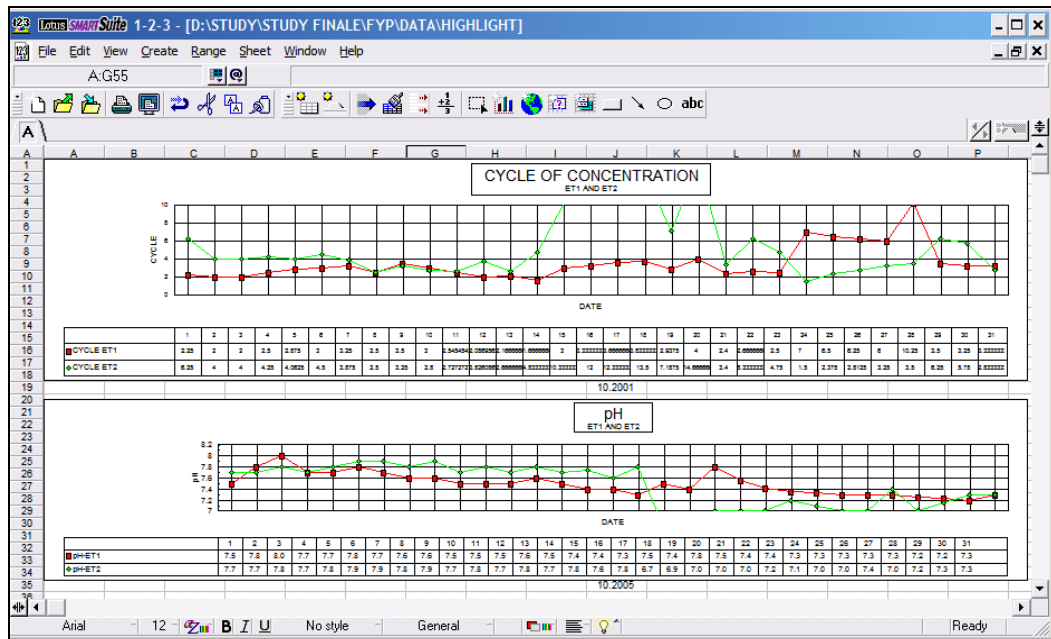

Some cooling water data record

## APPENDIX D – Passivation report data

	A	B	C	D	E	F	G	H	I	J	K	L
1	ET DEGREASING AND PASSIVATION											
2												
3	DATE	TIME	ACTIVITIES	RESULT	REMARK							
4	13-Aug	10:00	ET2 CW SAMPLE	Turb	8	Water to be use for degreasing						
5				pH	7.2	and passivation						
6				Cond	254							
7				Fe	0.5							
8				PO4	4.8							
9												
10	13-Aug	15:00	Filling T841	None								
11		15:30	Drain T841		Flushing HEX from large debris							
12		15:45	Filling T841									
13		16:00	Start circulation									
14		16:15	Sampling	Turb	21							
15				pH	7							
16				Fe	1.8							
17				Oil and Grease	< 1							
18		17:45	Add 15kg N7308									
19	14/8/2007	6:00	Drain and flushing T841									
20		8:30	Filling T841									
21		10:30	Start circulation									
22		12:00	Sampling									
23				Turb	5							
24				pH	6							
25				Fe	2.9							
26				Calcium	10							
27				Oil and Grease	< 1							
28				PO4	36							
29		12:30	Add 2 kg CaCl2		To boost Calcium hardness							
30		14:00	Sampling		Water for passivation							
31				Turb	5							
32				pH	6.3							
33				Fe	2.8							
34				Calcium	37							
35				PO4	35							
36				Conductivity	122							
37		14:30	Add 40kg Nalprep III									
38	Blowdown											

### Passivation activity record

S68	F	G	H	I	J	K	L	M	N	O	P	Q	R	S
37														
38														
39														
40														
41														
42														
43														
44														
45	PASSIVATION DATA													
46														
47					14-Aug-07				15-Aug-07					
48	PARAMETER	14:00	15:00	16:00	20:00	22:00	12:00	2:00	3:00	5:00	6:30	7:00	9:00	11:00
49	pH	6.3	7.2	7.5	7.9	8.2	8	7.7			6.1		11.2	11
50	Iron	2.8	24	28	30	33	78	81			3.1		5.2	5.3
51	Cond	122	315	332	320	334	285	357			111		2810	2750
52	TIP		517	420	370	350	314	300						
53	O-phosphate(Unfilter)	35	398	370	350	345	300	294			20.4		408	383
54	O-phosphate(Filter)												398	375
55	Delta O-Phosphate												10	8
56	Turbidity	5	8	8	10	11	34	51					5	6
57														
58														
59		15-Aug	16:00	Check corrosion coupon										
60		16-Aug	16:00	Check corrosion coupon										
61		17-Aug	16:00	Add 8 kg DN2760										
62													Suspected contaminated service water	

### Passivation data monitored