

INTEGRATED RENEWABLE ELECTRICITY GENERATING SYSTEM

By

LEE SHIN EN

FINAL PROJECT REPORT

Submitted to the Department of Electrical & Electronic Engineering
in Partial Fulfillment of the Requirements
for the Degree
Bachelor of Engineering (Hons)
(Electrical & Electronic Engineering)

Universiti Teknologi PETRONAS

Bandar Seri Iskandar

31750 Tronoh

Perak Darul Ridzuan

© Copyright 2012

by

Lee Shin En, 2012

CERTIFICATION OF APPROVAL

INTEGRATED RENEWABLE ELECTRICITY GENERATING SYSTEM

by

Lee Shin En

A project dissertation submitted to the
Department of Electrical & Electronic Engineering
Universiti Teknologi PETRONAS
in partial fulfilment of the requirement for the
Bachelor of Engineering (Hons)
(Electrical & Electronic Engineering)

Approved:

A.P. Dr. Balbir Singh Mahinder Singh
Project Supervisor

UNIVERSITI TEKNOLOGI PETRONAS
TRONOH, PERAK

May 2012

CERTIFICATION OF ORIGINALITY

This is to certify that I am responsible for the work submitted in this project, that the original work is my own except as specified in the references and acknowledgements, and that the original work contained herein have not been undertaken or done by unspecified sources or persons.

LEE SHIN EN

ABSTRACT

The main aim of this project is to design an effective hybrid solar-wind electricity generating system (W_Select) to ensure sustainable power supply. Electricity generated by photovoltaic (PV) panel and wind turbine is highly dependent on the availability of sunlight and wind respectively. Therefore, in order to ensure that the electricity supply is enough and sustainable, wind electricity generation system is needed to be combined with the solar electricity generating system to meet the load demand when sunlight is insufficient. In this project, solar photovoltaic panels, wind generators, electricity storage system and the methods of integration are studied. For the methodology of the project, PV panel and wind turbine is connected in parallel to the integrated system to regulate the electricity generated with the voltage of storage system. A prototype of W_Select was designed. The findings from the experiments on the prototype shown that the power contribution of wind electricity in W_Select is low, thus it can help solar electricity in generating electricity when there is no sunlight. Then, software is designed according to the findings. In conclusion, this project is successful. The efficiency of W_Select can be improved by improving the design and material of wind turbine.

ACKNOWLEDGEMENTS

First, I would like to acknowledge and offer my deepest appreciation to my project supervisor, A.P. Dr. Balbir Singh for his support and guidance throughout the two semesters of Final Year Project. His advices have helped me in completing this project successfully. I am grateful to my parents for their care and support. They have been there supporting and providing for me throughout my whole project. Besides, I would like to extend my gratitude to Mr. Shawari for his assistance and guidance. Next, I would like to thank Ms. Athirah for the help she extended. Finally, I would like to acknowledge the Electrical & Electronic Engineering Department and Fundamental & Applied Sciences Department, of Universiti Teknologi PETRONAS for the support in carrying out this Final Year Project, which is also partially financed by using the Fundamental Research Grant Scheme (FRGS) and Prototype Research Grant Scheme (PRGS), both from Ministry of Higher Education, Malaysia.

TABLE OF CONTENTS

LIST OF TABLES.....	viii
LIST OF FIGURES	ix
LIST OF ABBREVIATIONS	x
CHAPTER 1 INTRODUCTION.....	1
1.1 Background of Study.....	1
1.2 Problem Statement	2
1.3 Objectives	2
1.4 Scope of Study	3
CHAPTER 2 LITERATURE REVIEW	4
2.1 World Energy Outlook.....	4
2.1.1 The Price Environment	4
2.1.2 Energy Resources Used For Generating Electricity	5
2.1.3 Impact on Environment.....	6
2.2 Malaysia’s Energy Scenario	6
2.2.1 Malaysia’s Energy Resources For Generating Electricity	6
2.2.2 Impact on Local Environment	7
2.3 Potential of Renewable Energy.....	8
2.3.1 Renewable Energy Act 2011	8
2.3.2 Implementation Strategy by Government	8
2.3.2.1 Feed-in Tariff	9
2.4 Renewable Energy Based Solution.....	10
2.4.1 Solar Energy Technology.....	11
2.4.2 Optimization of PV Based System	12
2.4.3 Modelling of Photovoltaic Panel	13
2.4.4 Wind Energy Technology	13
2.4.5 Power of Wind.....	14
2.4.6 Modelling of Wind Turbine.....	14
2.5 Battery Storage.....	15
2.5.1 Lead-acid.....	15
2.5.2 Deep Cycle Batteries.....	16
2.5.3 Battery Bank.....	17
2.6 Charge Controller.....	18

CHAPTER 3 METHODOLOGY	19
3.1 Methodology	19
3.2 Project Activities	20
3.3 The Design of W_Select	21
3.4 Gantt Chart	22
3.5 Tools	23
CHAPTER 4 RESULTS AND DISCUSSION	24
4.1 The Layout of W_Select	24
4.2 Electrical Load Analysis	25
4.3 The Capacity of W_Select	25
4.4 Solar Power	26
4.5 Comparison of Wind Turbine Designs	26
4.5.1 Wind Turbine Design A	27
4.5.2 Wind Turbine Design B	28
4.5.3 Wind Turbine Design C	29
4.6 The Prototype of W_Select	30
4.7 Performance of W_Select	32
4.8 The Power Obtained from W_Select	33
4.9 Analysis Using Homer Software	33
4.10 The Software for W_Select	34
CHAPTER 5 CONCLUSION AND RECOMMENDATIONS	36
5.1 Conclusion	36
5.2 Recommendations	36
REFERENCES	37
APPENDICES	40
APPENDIX A SOFTWARE CODING	40

LIST OF TABLES

Table 1: Electricity Production Based On Different Sources	7
Table 2: Solar Energy and Surface Meteorology	11
Table 3: Comparison between Monocrystalline and Polycrystalline	11
Table 4: The Characteristics of Different Lead-Acid Batteries	16
Table 5: Gantt Chart and Key Milestone	22
Table 6: Tools Used	23
Table 7: Typical Power Consumption of Suburban Household	25
Table 8: Performance Of W_Select At Different Wind Speed	32
Table 9: COMPARISON OF TWO EXPERIMENTS	33

LIST OF FIGURES

Figure 1: Shares of Energy Sources in World Primary Demand	4
Figure 2: Key Crude Oil Spot prices in USD/barrel	5
Figure 3: Distribution of Energy Resources for Electricity Production	5
Figure 4: The Fuel Share of Carbon Dioxide Emission in 2009	6
Figure 5: Malaysian's Emission from Fossil Fuels Consumption	7
Figure 6 : FiT Rates for Solar PV	9
Figure 7 : Solar Insolation in UTP	10
Figure 8 : Wind Speed Measured at Pantai Teluk Lipat, Dungun, Terengganu	10
Figure 9: Zenith Angle and Azimuth Angle	12
Figure 10: Characteristics of Single-Stage and Multistage Battery Charging	18
Figure 11: Methodology	19
Figure 12 :Project Activities for FYP	20
Figure 13: Design of W_Select	21
Figure 14: Layout of W_Select	24
Figure 15: Graph of Power generated.....	26
Figure 16: Wind Turbine Design A.....	27
Figure 17 : The Voltage Produced by Wind Turbine Design A at 6.5m/s Wind Speed	27
Figure 18: The Voltage Produced by Wind Turbine Design A at 4.8m/s Wind Speed.....	28
Figure 19: Wind Turbine Design B	28
Figure 20: Wind Turbine Design C	29
Figure 21: The Voltage Produced by Wind Turbine Design C at 5.0m/s Wind Speed	29
Figure 22: The Voltage Produced by Wind Turbine Design C at 4.2m/s Wind Speed	30
Figure 23: Prototype of W_Select	31
Figure 24: Arrangement of W_Select.....	31
Figure 25: Monthly Average Electric Production	33
Figure 26: Example 1 of W_Select Software.....	34
Figure 27: Example 2 of W_Select Software.....	35

LIST OF ABBREVIATIONS

AGM	: Absorbed Glass Mat Electrolyte
ASEAN	: Association of Southeast Asian Nations
DC	: Direct Current
FiT	: Feed-in Tariff
FYP	: Final Year Project
HAWT	: Horizontal Axis Wind Turbine
PV	: Photovoltaic
SEDA	: Sustainable Energy Development Authority Malaysia
UNDP	: United Nation Development Programme
USD	: United States Dollar
VAWT	: Vertical Axis Wind Turbine
W_Select	: Solar-wind electricity generating system
WTI	: West Texas Intermediate

CHAPTER 1

INTRODUCTION

1.1 Background of Study

Global warming is a critical issue that needs the attention of every country. The combustion of fossil fuels in power generation will increase a country's carbon emission, air pollution, and leads to global warming. In Malaysia, fossil fuels such as gas and coal are the major portion of energy supply. It is vital to find alternative ways that are environmental friendly and sustainable. Therefore, Malaysia encourages the use of renewable resources as alternative sources to generate electricity by introducing Five-Fuel Diversification Strategy energy mix under Eighth Malaysia Plan (2001-2005), in order to be less dependent on fossil fuels [1].

The conventional method of electricity generating system, which is by combusting fossil fuels, has another issue that should be concern. The cost of fossil fuel is high and fluctuates according to the market. Moreover, fossil fuels are expected to run out after decades [2]. The decreasing global supply of fossil fuels is affecting its price to fluctuate. If the world is still highly dependent on fossil fuel, the fossil fuel supply will not be able to reach the level of demand in the future. Therefore, it is wise to choose renewable energies over fossil fuels as a solution for the future. Solar radiation that reaches the earth alone is able to generate an abundance amount of electricity. Unlimited wind energy is also flowing from high-pressure areas to low pressure areas. Thus, renewable sources like solar and wind are good alternatives over fossil fuels, as they are always free and unlimited.

In order to benefit from the unlimited solar and wind resources of the nature, solar-wind electricity generating system is needed to generate electricity from them. There are two methods to generate electricity from solar energy. The first is by using the relative movement of a magnetic field, a conductor and a turbine. The second method, which is also the most popular method, is by using photovoltaic cell. Photovoltaic technology uses the properties of doped semiconductor silicon to convert solar radiation into electricity directly without any moving parts. The power harvested

from the sunlight depends on the solar irradiance on the solar panel surface [3]. On the other hand, wind turbines are used to generate electricity from wind energy. Wind turbine extracts energy from the wind to spin a rotor that in turn, connects to a generator to produce electricity. The electricity produced from the wind is dependent on the wind speed and the area swept by the turbine blades [4]. Solar-wind electricity generating system (W_SELECT) will combine both solar and wind technologies to achieve adequate and sustainable electricity supply.

1.2 Problem Statement

Currently, there is no single renewable energy technology that is able to provide viable solution to green and clean electricity generation. In solar electricity generation, solar radiation fluctuates due to the apparent trajectory of the sun. The quality of solar radiation received on the surface of the earth during daytime is also subjected to other conditions, such as the meteorological condition, cloudiness and haziness of the environment can affect the quality of solar radiation received on the surface of the earth. A standalone solar power generator without any battery bank or diesel generator is unable to produce continuous electricity to the users. As for wind electricity generation, it is affected by the inconsistency of wind speed and wind direction. Hence, there is a need to find viable design that can overcome the problem associated with the transient nature of both solar and wind energy resources. Implementation strategies are also needed to match the load and supply of electricity from solar panels and wind generators.

1.3 Objectives

The objectives of this project are:

1. To design a viable renewable energy based electricity-generating system.
2. To analyse the performance of the integrated solar-wind hybrid system.
3. To develop a software for the integration of solar-wind electricity.

1.4 Scope of Study

The scope of study is basically revolving around the need to design an effective solar-wind electricity generating system (W_SELECT).

- There is a need to study the solar photovoltaic panels, wind generators and electricity storage system.
- There is a need to study the charge controllers and the method to dump excessive electricity.
- There is a need to study the existing integrating solution of solar and wind hybrid system.

CHAPTER 2

LITERATURE REVIEW

2.1 World Energy Outlook

Oil is the world's leading energy source, which consists of 33.6% of global energy demand, yet is decreasing for 11 years continuously. However, commercial renewable energy grew by 5.6% in year 2010 [5]. In World Energy Outlook 2011, renewable energy is expected to meet a two-third increment of energy demand from year 2010 to year 2035 [6]. These show that the energy industry of the world is diverting to renewable energy.

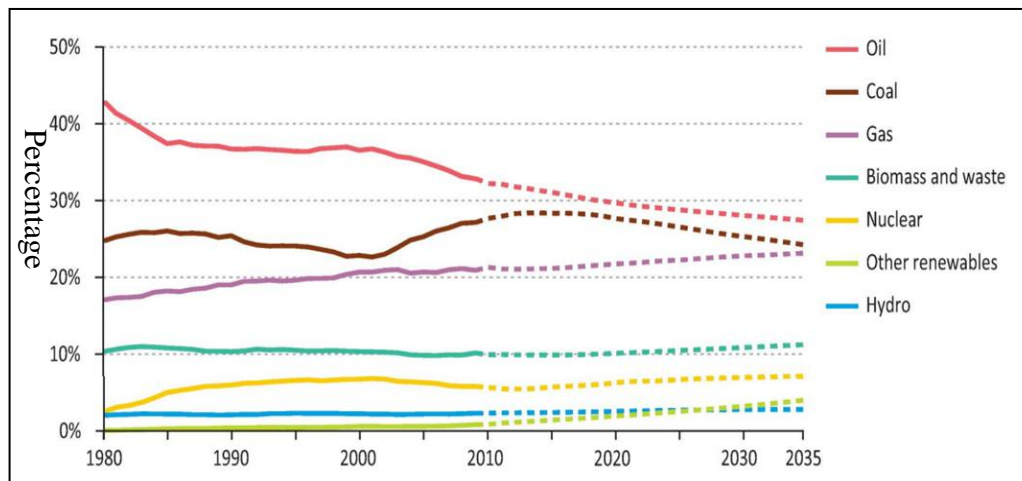

Figure 1: Shares of Energy Sources in World Primary Demand [6]

2.1.1 The Price Environment

Oil is the leading energy source. Therefore, it is important to have a stable and secure price environment that the oil producers and customers can estimate their budget [7]. However, Fig. 2 below shows that crude price has a record of high fluctuation [8]. Hence, alternate energy that has a more predictable and stable price is needed. Renewable energies such as solar energy and wind energy have more predictable price since the resources are free and unlimited.

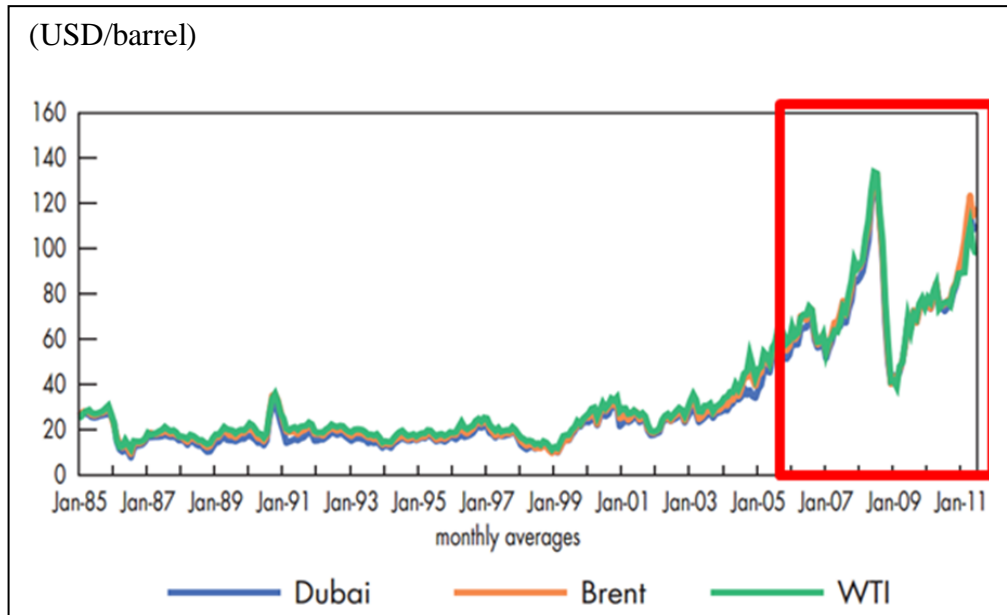
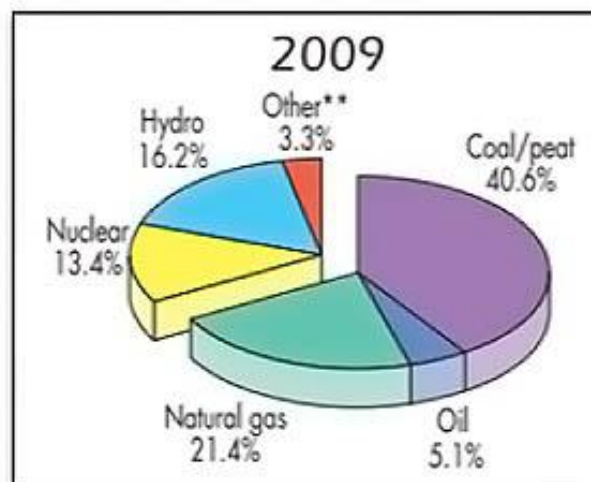

Figure 2: Key Crude Oil Spot prices in USD/barrel [8].

2.1.2 Energy Resources Used For Generating Electricity

In year 2009, the world has a total electricity production of 20055TWh. The pie chart in Fig. 3 shows the distribution of energy resources used for electricity production of the world. From the chart, renewable energy has only 19.5% share of total energy resources. The largest contributor in electricity generation is coal or peat, which consists of 40.6% of the total resources [8].



*Excludes pumped storage.
 **Other includes geothermal, solar, wind, biofuels and waste, and heat.

Figure 3: Distribution of Energy Resources for Electricity Production [8]

2.1.3 Impact on Environment

Fossil Fuels in energy generation have contributed in greenhouse gases emission and climate change. The high rising carbon dioxide emission from fuel combustion is a global challenge today. From year 2010 until year 2035, carbon dioxide emission from power sector is estimated to increase 6.2%, and the cumulative of carbon dioxide emission is expected to reach higher than three-quarters of the cumulative since 1900 until 2009 [6]. If the world does not change the direction of power generations, industries and transportations to renewable energy resources, the impact on the environment will be more severe. The rising incomes and populations will increase the energy demand, and increase the carbon dioxide emission [6]. The pie chart in Fig. 4 shows the fuel share of carbon dioxide emission of the total 28999Mt, in year 2009 [8].

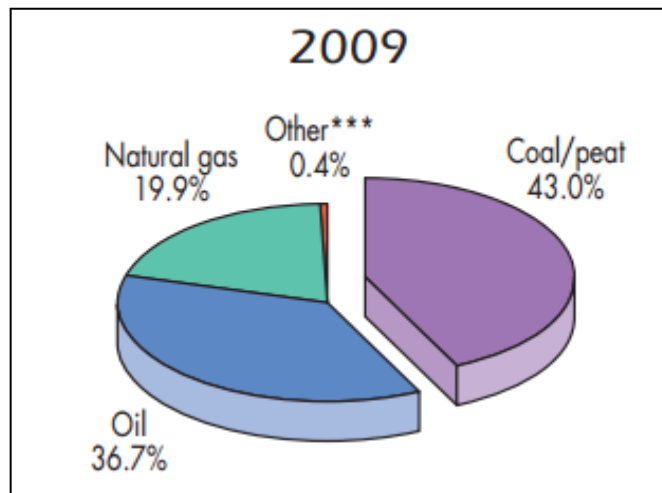

Figure 4: The Fuel Share of Carbon Dioxide Emission in 2009 [8]

2.2 Malaysia's Energy Scenario

In 2009, Malaysia has a total of 89.69Mtoe energy production [9]. The following subsections will provide the details.

2.2.1 Malaysia's Energy Resources For Generating Electricity

In Malaysia, 93.6% of total electricity productions is generated from fossil fuels reported that in year 2009. Table 1 shows that gas and coal are the largest source of power generation [10]:

Table 1 : Electricity Production Based On Different Sources [10]

Resources	Electricity Produced (GWh)
Coal and Peat	32495
Oil	2103
Gas	63812
Hydro	6671
Total	105081

2.2.2 Impact on Local Environment

According to UNDP Human Development Report 2007/2008, Malaysia contributes to 0.7% of the global carbon dioxide emissions. However, the country's emission intensity level, which is a ratio of greenhouse gases emissions to gross domestic product, is higher than global average in the energy sector [11]. In fact, Malaysia ranked 33 in carbon dioxide emission from fossil fuels in the world, with 149.84 Million Metric Tons emission [12]. Energy consumption grows as a country's economic and social development grows. Malaysia has the second highest electricity consumption in ASEAN members [13]. If the country continues to generate electricity mainly from fossil fuel resources, air pollution will be worsen as the country develops. Therefore, Malaysia should emphasize on generating green electricity from renewable energy to improve air quality and to stop climate change.

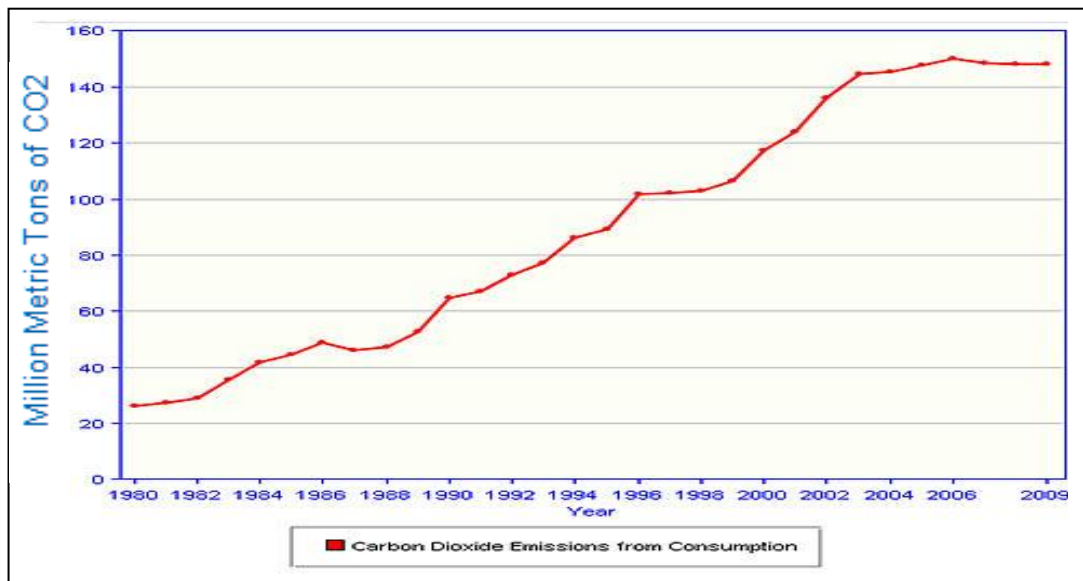

Figure 5: Malaysian's Emission from Fossil Fuels Consumption [12]

2.3 Potential of Renewable Energy

Coal reserves globally are approximated to last around 118 years at current production rate. Besides, oil and gas can only last for 46 and 59 years respectively at current rate of production [2]. Therefore, Malaysia needs to carve new route to generate electricity. Most countries have planned to develop nuclear power plant to generate electricity. However, after the nuclear disaster in Fukushima, safety measures are taken more severely and need to be strengthened [7]. Renewable resources have great potential comparing to uranium because nuclear energy needs very high technology and has a high risk of danger. Renewable energies are also known to have less harm toward the environment. Thus, research and developments are needed for renewable technologies that are not mature.

2.3.1 Renewable Energy Act 2011

Malaysian government has taken effort to encourage environmentally friendly townships and neighbourhoods. However, renewable energy needs government's law enforcement to grow. Renewable Energy Act is to push the interested parties to develop renewable energy effectively. The act has established Feed-in Tariff (FiT) system under the administration of Sustainable Energy Development Authority Malaysia (SEDA). Under the bill, Renewable Energy Fund is established to support renewable energy development. The fund is controlled by SEDA. The sums of the fund are provided by the parliament from time to time for distribution licensees to pay FiT for electricity feed-in [14]. The government is aiming for 985MW renewable energy by 2015 [11].

2.3.2 Implementation Strategy by Government

The Sustainable Energy Development Authority is a government body formed under the Laws of Malaysia Act 726. All functions of SEDA are granted under Renewable Energy Act 2011. The role of SEDA is to promote and implement renewable energy parallel to the sustainable energy law. SEDA also encourages private sector investment on sustainable energy and advises the Government on sustainable energy [15].

2.3.2.1 Feed-in Tariff

Malaysia is introducing Feed-in Tariff (FiT) to let the distribution licensees like Tenaga Nasional Berhad to buy renewable electricity feed-in to the national grid from feed-in approval holders for a specific period. FiT system will as well provide the connection to grid for the distribution of renewable electricity generated. The distribution licensees pay for each unit of renewable electricity based on the FiT rates. The renewable resources included in FiT are biogas, biomass small hydro plant and solar photovoltaic. Solar photovoltaic (PV) has the highest FiT rates among the options, which is at RM0.85-RM1.23 per kWh [15]. Thus, it is most profitable to install solar PV. However, wind electricity generation system should be combined to the photovoltaic system in hybrid to produce consistent and green electricity.

Description of Qualifying Renewable Energy Installation	FiT Rates (RM per kWh)		
	2011	2012	2013
(a) Basic FIT rates having installed capacity of :			
(i) up to and including 4kW	1.2300	1.2300	1.1316
(ii) above 4kW and up to and including 24kW	1.2000	1.2000	1.1040
(iii) above 24kW and up to and including 72kW	1.1800	1.1800	1.0856
(iv) above 72kW and up to and including 1MW	1.1400	1.1400	1.0488
(v) above 1MW and up to and including 10MW	0.9500	0.9500	0.8740
(vi) above 10MW and up to and including 30MW	0.8500	0.8500	0.7820
(b) Bonus FIT rates having the following criteria (one or more) :			
(i) use as installation in buildings or building structures	+ 0.2600	+ 0.2600	+ 0.2392
(ii) use as building materials	+ 0.2500	+ 0.2500	+ 0.2300
(iii) use of locally manufactured or assembled solar PV modules	+ 0.0300	+ 0.0300	+ 0.0276
(iv) use of locally manufactured or assembled solar inverters	+ 0.0100	+ 0.0100	+ 0.0092

Figure 6 : FiT Rates for Solar PV [15]

2.4 Renewable Energy Based Solution

In the project, solar-wind electricity generating system (W_Select) is chosen because a standalone solar power generation without diesel generator is not viable. The right implementation strategies need to have two or more renewable energy technologies. Electricity generated by PV panel is highly dependent on the availability of sunlight. Sunlight which is available during daytime is also subjected to other conditions, such as the meteorological conditions, cloudiness and haziness of the environment. These will affect the quality of solar radiation received on the surface of the earth. The graph in Fig. 7 shows the solar insolation taken in Universiti Teknologi PETRONAS from 7.00 am until 8.00pm. The insolation shown is very unstable. No insolation is

detected before 7.00 am and after 6.00pm. Therefore, solar panels alone are unable to generate continuous electricity to meet the demand when there is no sunlight.

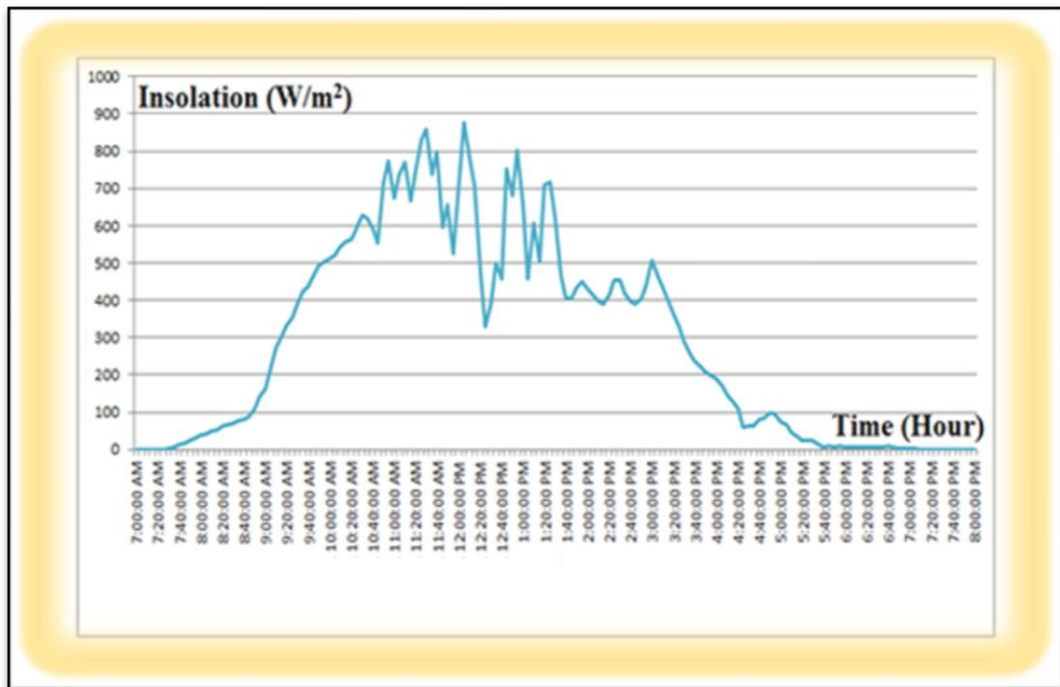

Figure 7 : Solar Insolation in UTP [16]

On the other hand, wind blows and wind speeds are unpredictable as shown in the graph in Fig. 8. Therefore, wind energy technology alone is similarly not a viable solution to provide continuous electricity. Wind turbines are unable to generate electricity when there is no wind. However, Wharton and Lundquist have proven that wind speeds are higher at night comparing to daytime, and night time has more stable wind over daytime [17].

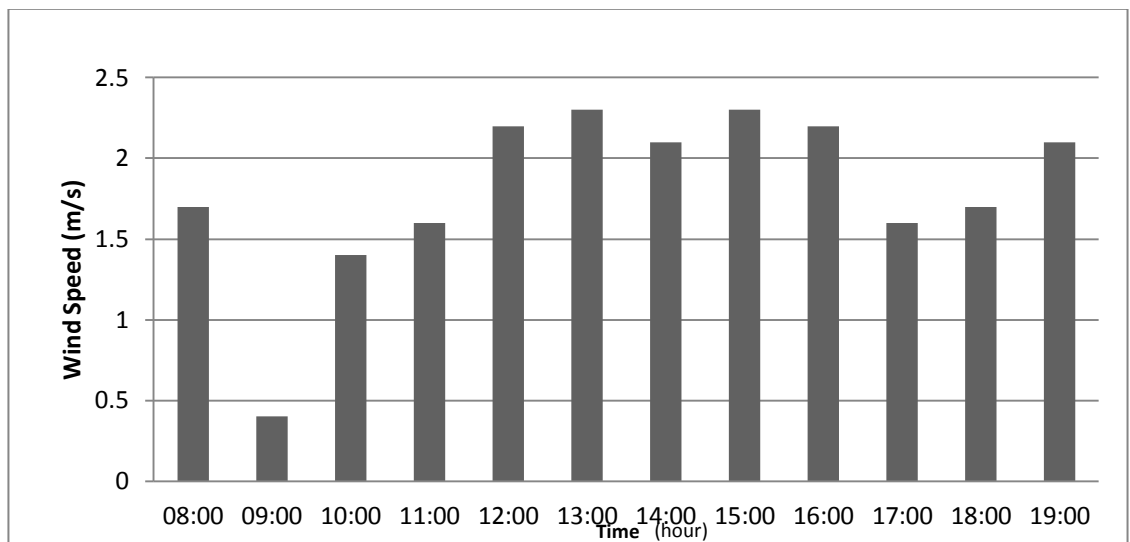

Figure 8 : Wind Speed Measured at Pantai Teluk Lipat, Dungun, Terengganu

Wind power is as green as solar power, as both of them do not produce greenhouse gases. As a result, solar and wind power generators should be combined and regulated to produce continuous and cheaper electricity.

Table 2 shows the solar insolation, clearness, temperature and wind speed in Kuala Lumpur, Malaysia. The information will be used in customizing Homer software to analyse the performance of the solar-wind electricity generating system.

Table 2: Solar Energy and Surface Meteorology [18]

Months	Jan	Feb	Mar	Apr	Ma y	Jun	Jul	Aug	Sep	Oct	Nov	Dis
Insolation, kWh/m²day	4.29	5.06	5.22	5.33	5.08	4.91	4.87	4.99	5.04	4.83	4.21	3.77
Clearness, 0-1	0.45	0.50	0.50	0.52	0.51	0.51	0.50	0.50	0.49	0.48	0.43	0.40
Temp, °C	24.3 5	24.9 8	25.6 2	26.0 7	26.1 0	25.7 3	25.3 4	25.3 9	25.5 0	25.7 3	25.2 6	24.5 8
Wind Speed, m/s	3.56	2.97	2.61	1.61	1.58	2.58	2.58	2.78	2.17	1.72	2.58	3.56

2.4.1 Solar Energy Technology

The solar electricity can be generated by using photovoltaic panels. There are several types of silicon PV cells in the market, such as monocrystalline silicon, polycrystalline silicon, thin film, amorphous silicon and dye-synthesized solar cell. They defer in efficiency, structure and price. Monocrystalline and polycrystalline has the highest efficiency among all types of solar panel, which are 13-17% and 12-15% respectively [19].

Table 3 : Comparison between Monocrystalline and Polycrystalline [19]

	Monocrystalline	Polycrystalline
Efficiency	13-17%	12-15%
Price	High	Slightly lower
Effect from Temperature	Better performance in cooler conditions	Better performance in warmer conditions
Life Span	Long	Long

In the project, polycrystalline solar panel is chosen because it is more cost effective. In addition, Malaysia is a tropical country with warmer climate, where the project could benefits from the better performance of polycrystalline.

2.4.2 Optimization of PV Based System

The angle between the sun and the line perpendicular to the earth's surface is called the zenith angle or the angle of incident (θ). The angle between the sun and the north-south axis is the azimuth angle (γ) [20].

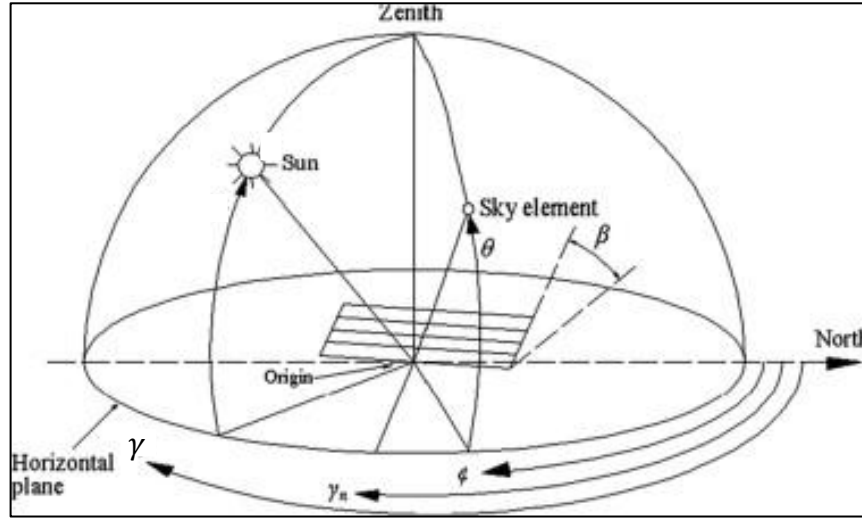

Figure 9: Zenith Angle and Azimuth Angle [20]

In a day without clouds or haze, noon is the time with most sunlight. The angle of incident θ needs to be equal to zero to achieve optimum solar electricity generation from the panel. The solar panel has to be tilted towards the equator with slope β of the panel is equal to the latitude ϕ . Besides, the azimuth angle γ should be 0 [3]. Since Malaysia is above the equator, therefore the solar panel should be oriented towards south.

The equation for angle of incident is [3]:

$$\cos \theta = (A - B) \sin \delta + [C \sin \omega + (D + E) \cos \delta] \quad (1)$$

Where,

$$A = \sin \phi \cos \beta$$

$$B = \cos \phi \sin \beta \cos \gamma$$

$$C = \sin \beta \sin \gamma$$

$$D = \cos \phi \cos \beta$$

$$E = \sin \phi \sin \beta \cos \gamma$$

The geographic coordination of Universiti Teknologi PETRONAS is latitude 4.38 N, longitude 100.97E. Therefore, the solar panel in Universiti Teknologi PETRONAS should be oriented with slope of 4.38°, facing South.

2.4.3 Modelling of Photovoltaic Panel

The daily output of the PV panel of certain power is estimated by using the average sunlight hours. In Malaysia, the average sunlight hours is 6 hours [21]. Therefore, the equation for daily output of PV panel is expressed as below.

$$P_o \text{ (Wh/day)} = P \times \text{Average sunlight hours} \times 0.77 \quad (2)$$

Where, P is the power of solar panel (W) and 0.77 is the derating factor of solar panel. Derating factor is calculating the factors affecting the efficiency of solar panel, such as shading, dust, temperature, tilt angle and power conversion loss [22].

2.4.4 Wind Energy Technology

Wind turbine is used to generate electricity from wind energy. Wind turbine normally has a rotor, gearbox and generator. There are two basic types of wind turbines, which are Horizontal Axis Wind Turbines (HAWT) and Vertical Axis Wind Turbines (VAWT). For large-scale turbines, the three-bladed HAWTs are the more popular to produce multi-megawatts. For small-scale turbines, VAWTs have more benefits than HAWTs. VAWTs theoretically need less maintenance due to lesser and slower moving parts. VAWTs also have less noise since tip speeds are lower and no air compression from blades. Besides, VAWTs can have lower rotational speed and no need of yaw control, which are good points for a location with low speed wind and constantly changing wind direction. However, HAWTs are cheaper because fewer materials per metre of 'swept area' are needed [23].

In this project, VAWT is seen as a better option since Malaysia has low average wind speed and the wind blows from different directions. The average wind speed at Pantai Teluk Lipat, Terengganu is recorded as 1.8 m/s, which is consider as low wind velocity. The focus of the project is on suburban and coastal areas, therefore no need of mega large-scale turbines.

2.4.5 Power of Wind

The electrical power that can be harvest from the wind can large, depending on the capacity of the generator. It is in fact proportional o the cube of wind speed. The calculations of the power of wind are as below [4]

$$\begin{aligned} Power &= \frac{Work\ Done}{Time\ Taken} \\ &= \frac{1}{2} \frac{mv^2}{t} \end{aligned} \quad (3)$$

Where,

m = mass of wind (kg)

v = wind speed (m/s)

t = time taken (s)

Since *mass flow*, $\frac{m}{t} = \rho Av$, therefore

$$Power = \frac{1}{2} \rho Av^3 \quad (4)$$

Where,

ρ = air density (kg/m^3)

A = swept area (m^2)

v = wind speed (m/s)

2.4.6 Modelling of Wind Turbine

The mathematical modelling of wind turbine, the power generation from the turbine is predicted. Wind turbine converts wind energy into electricity. The formula below shows the power that can be produced by VAWT [24].

$$P_t = \frac{1}{2} \rho_{air} AV^3 C_p \quad (5)$$

Where, ρ_{air} is the air density, A is the area of the blades, V is the mean wind speed and C_p is the optimal aerodynamic power coefficient of the rotor blades. In Malaysia, the air density is $1.225\text{kg}/\text{m}^3$ and average wind speed is at 3 m/s [4]. Besides, The theoretical maximum power coefficient or Betz limit, C_p is 0.59. However, for crude drag turbine, the coefficient C_p is 0.20 which is one-third of Betz limit [25].

2.5 Battery Storage

Solar and wind are irregular power sources, they cannot meet the load demand 24 hours continuously daily. Therefore, it is crucial to choose the suitable type of battery to supply power to the load when sunlight and wind are insufficient or during maintenance [26]. Batteries store energy in electrochemical form. There are six major types of secondary batteries available in the market, which are lead-acid, nickel-cadmium, nickel-metal hydride, lithium-ion, lithium-polymer and zinc-air. Lead-acid is the most common among all rechargeable batteries because it is less costly though it has the least energy density by weight and volume [27].

2.5.1 Lead-acid

The lead–acid battery has been dominant in the market especially automotive applications [28]. Lead-acid batteries are used widely in off-grid solar power system due to their long lifespan and cheaper price compare to other types of batteries. Statistics indicate that lead-acid batteries used in solar and wind systems stand 5% of the entire lead-acid battery market [26]. However, they need regular maintenance such as refilling water, equalizing charge and cleaning the terminals [29]. Water refilling is needed as the result of gassing, where decomposition of water into hydrogen and oxygen gases when the chemical reaction unable to keep up with the charging input.

For sealed electrolyte batteries, the most common types are Absorbed Glass Mat Electrolyte (AGMs) and Gelled Electrolyte. AGMs need less maintenance compare to flooded lead-acid batteries. AGMs are sealed, where there will be no spilling and no need of adding water or equalizing charge. In AGM, electrolytes do not deposit. Besides, AGM's self-discharge percentage is less than 2% during storage. Even though AGMs are convenient, they are more expensive than other types of batteries. Gelled electrolyte sealed lead acid batteries contain acid that turned into gel solid state by adding silica gel. The batteries will not spill and no watering or charge equalizing needed. However, charging of batteries is very slow because gas bubbles will form on the metal plates when being charged too fast. Therefore, the batteries' capacities will temporarily decrease until the bubbles escape because the bubbles block electrolyte contacts [30].

2.5.2 Deep Cycle Batteries

For renewable energy applications, it is important that the batteries chosen can be deeply discharged. Deep cycle batteries can sustain repeatedly discharge up to 80% of their depth of discharge and can be recharged without damage. Deep cycle batteries have thicker lead plates and smaller area of contact with electrolyte, which can sustain the current longer, yet at a lower current than shallow cycle batteries. However, deep discharging shortens the batteries lifespan. Therefore, it is best to use deep cycle batteries for renewable electricity storage without deeply discharging [29]. Table 4 shows the characteristics of different lead-acid batteries [31].

Table 4 : The Characteristics of Different Lead-Acid Batteries [31]

	TYPE	COST	AVAILABILITY	DEEP CYCLE PERFORMANCE
Flooded Electrolyte	Lead-antimony	Low	Very good	Good
	Lead-calcium opened-vent	Low	Very good	Poor
	Lead-calcium sealed-vent	Low	Very good	Poor
	Lead-antimony/ lead-calcium	Low	Limited	Good
Captive electrolyte	Lead-calcium sealed-vent	Medium	Limited	Fair
	Lead-antimony/ lead-calcium	Medium	Limited	Fair

Therefore, flooded lead-antimony electrolyte is the most suitable for renewable energy due to its low cost and high deep cycle performance and good temperature tolerance, though regular maintenance is needed [31].

2.5.3 Battery Bank

In order to provide sufficient voltage and capacity for the load requirements, batteries are connected together in series and in parallel. Battery bank must not use batteries of different types or ages. For series connection of batteries with similar voltage and current, circuit voltage is the sum of all batteries voltage, while current is the same as single battery. However, when batteries with different capacities are connected in series, the circuit capacity will be the same as the lowest capacity battery. For parallel connection of batteries with similar voltage and current, circuit capacity is the sum of the currents from different batteries. The circuit voltage is the same as the voltage a single battery. It is better to have few parallel strings, because slight differences of voltage between the strings will cause inconsistent charge received by each string. This will leads to unequal currents in the system. The batteries that receive less charge will have premature sulfation. Hence, it is better to connect large batteries in series than to have several parallel strings. If the load is large, it is recommended to use higher voltage and lower circuit current. Lower circuit current means lower size and cost of conductors, fuses and other current handling components [31].

2.6 Charge Controller

The electricity generated by solar and wind systems varies due to irradiance and wind speed. In the solar and wind power system, power conditioning is needed for safety purposes and minimizing losses. Charge controller is used to prevent overcharging of the batteries. Overcharging will cause gassing and faster wearing out. Charge controller regulates battery charge by managing the electricity flows between solar power system, wind turbine, battery and load. Batteries can be charged with single-stage battery charging or multistage battery charging. Single-stage charging is simple to control and low cost because charging is either on or off. When the battery is fully charged, charge controller will stop charging and recharge when the voltage of the battery drops to a preset level. Whereas, multistage battery charging method charges the battery in multiple steps where charge current is reduced when the battery charge reaches certain level. This is to maintain the battery in fully charged [31].

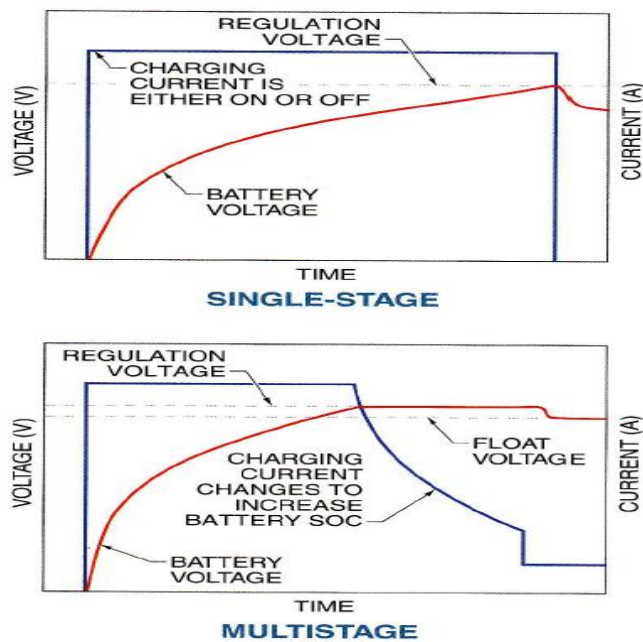

Figure 10: Characteristics of Single-Stage and Multistage Battery Charging [31]

Besides, there are two major types of charge controller, which are parallel charge controller and series charge controller. Series regulation is commonly used in photovoltaic applications [31].

CHAPTER 3

METHODOLOGY

3.1 Methodology

The methodology of this final year project is shown as Fig. 11.

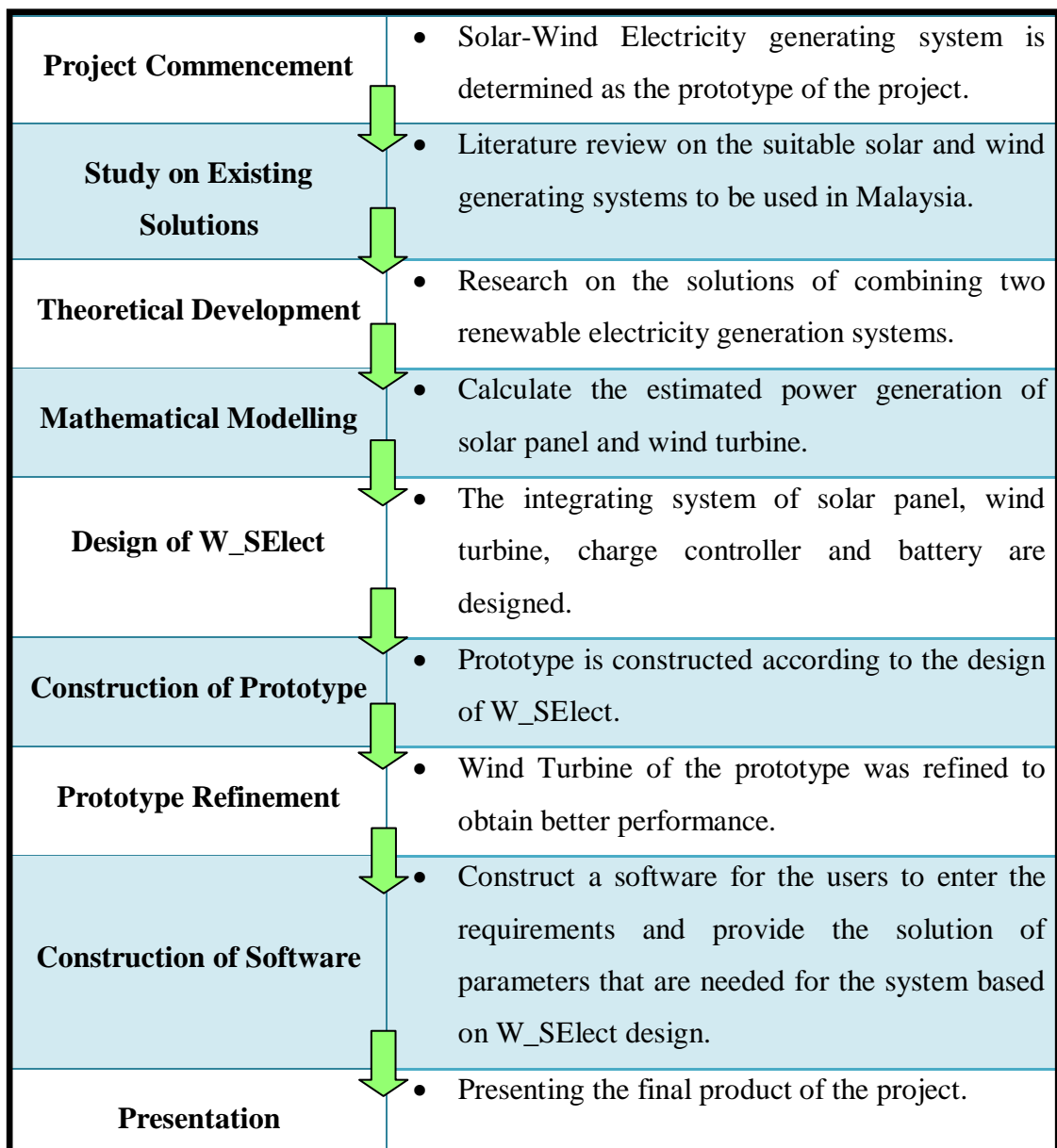

Figure 11: Methodology

3.2 Project Activities

The project activities of final year project are distributed into two parts, as shown in Fig. 12.

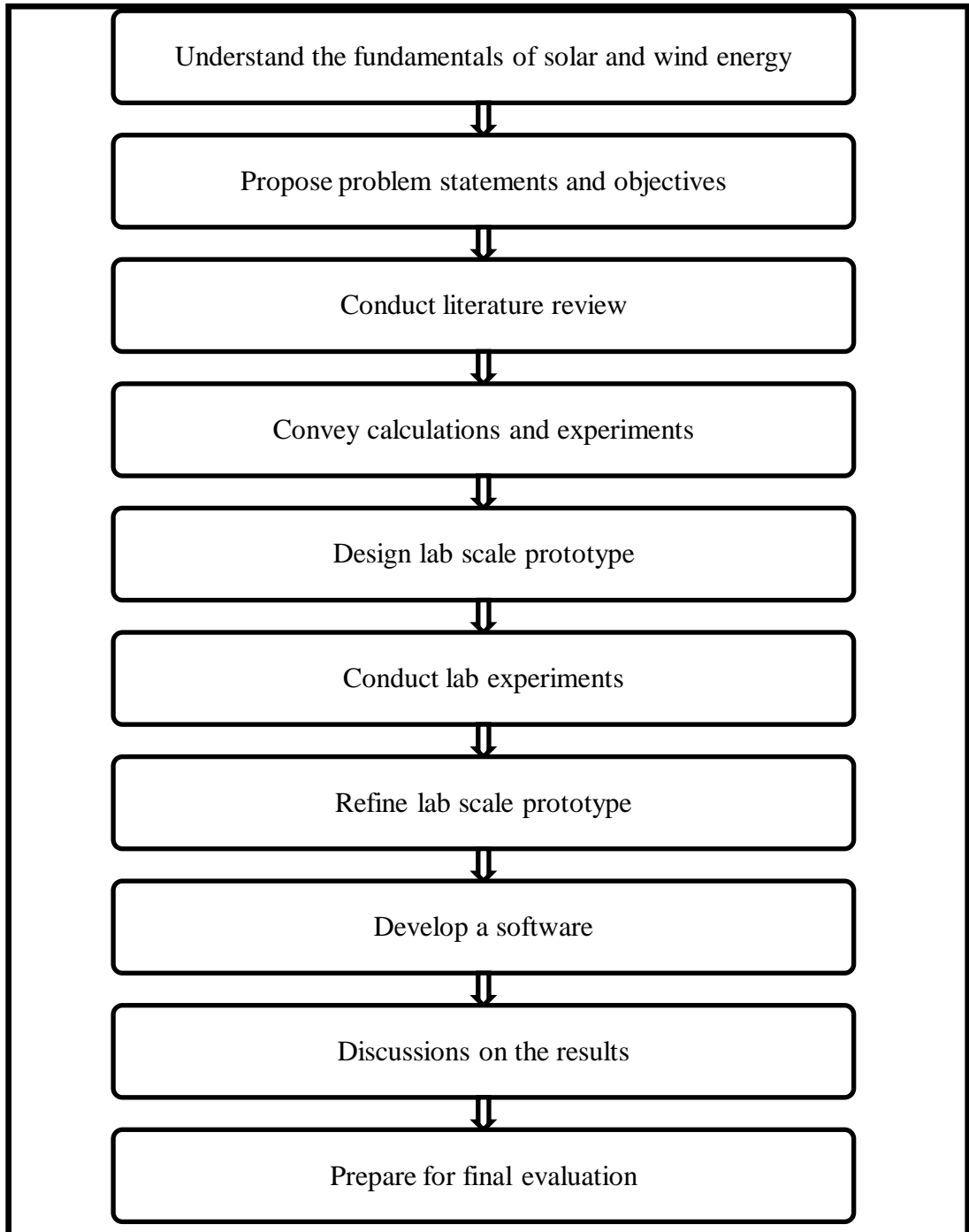

Figure 12 :Project Activities for FYP

3.3 The Design of W_SELECT

The process flow to design W_SELECT is as shown in Fig. 13:

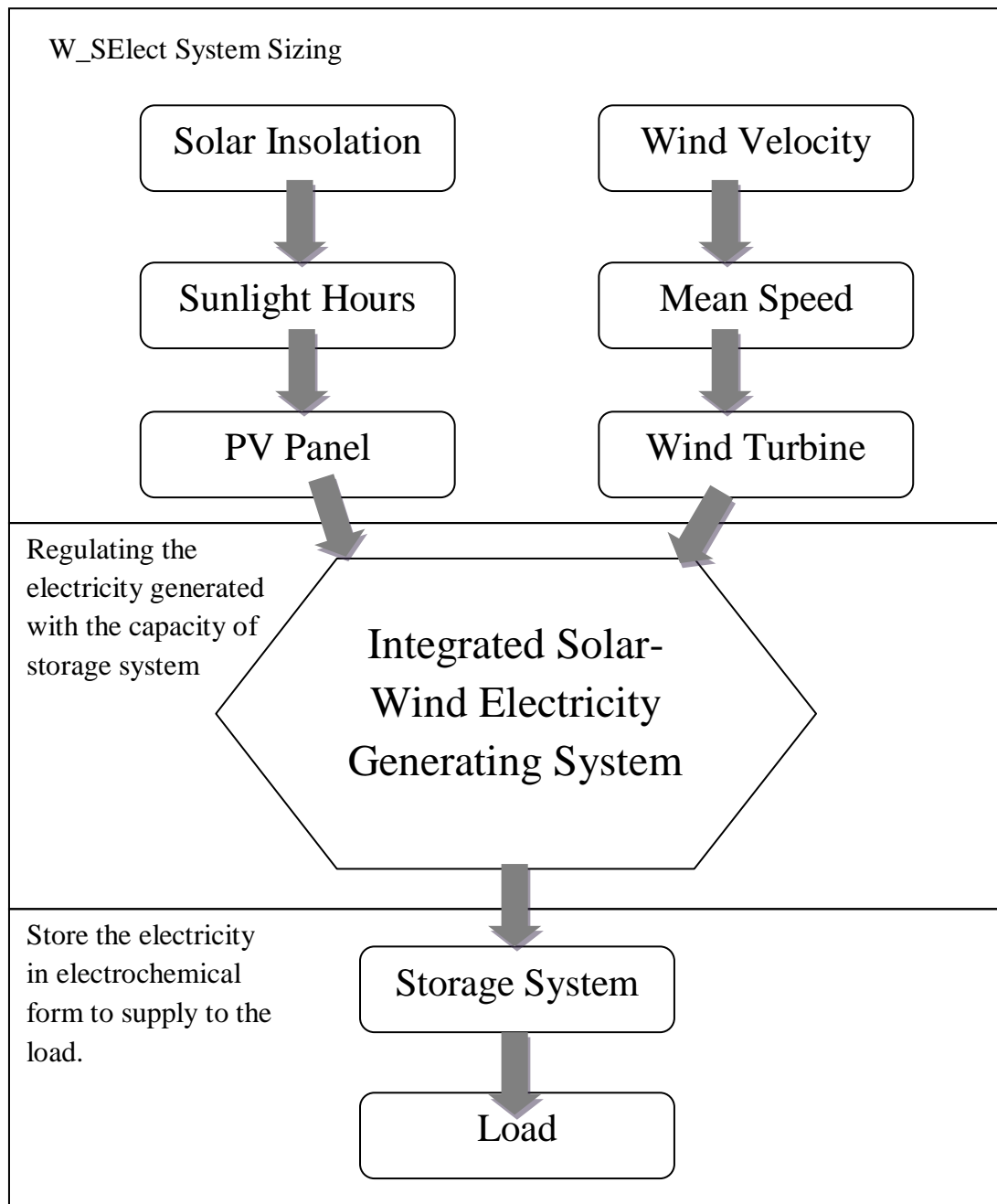



Figure 13: Design of W_SELECT

3.4 Gantt Chart

Table 5 below shows the gantt chart and key milestone of this project.

Table 5: Gantt Chart and Key Milestone

No	Details	Week														
		1	2	3	4	5	6	7	8	9	10	11	12	13	14	15
1.	Project Work Continues	■	■	■	■	■	■	Mid-Semester Break								
2.	Submission of Progress Report								■							
3.	Project Work Continues									■	■	■	■			
4.	Pre-SEDEX											■				
5.	Submission of Draft Report												■			
6.	Submission of Dissertation (Soft bound)													■		
7.	Submission of Technical Paper													■		
8.	Oral Presentation														■	
9.	Submission of Project Dissertation (Hard bound)															■

 **Key Milestone**
 **Process**

3.5 Tools

The tools used in this project are given in the table 6 below.

Table 6: Tools Used

Tools used for Experiments	Anemometer	<ul style="list-style-type: none"> • To measure wind speed
	Pasco Data Logger	<ul style="list-style-type: none"> • Computerised Data Acquisition System
	500W halogen spotlight	<ul style="list-style-type: none"> • To simulate solar insolation
	Industrial fan	<ul style="list-style-type: none"> • To provide the wind for simulation power generation using W_SELECT
Software tools	Homer Software	<ul style="list-style-type: none"> • To analyse the monthly electric production of W_SELECT
	Data Studio	<ul style="list-style-type: none"> • Data acquisition, display and analysis software program
	Microsoft Visual Basic 2010	<ul style="list-style-type: none"> • To develop W_SELECT Software

CHAPTER 4

RESULTS AND DISCUSSIONS

4.1 The Layout of W_Select

The layout of this project is shown as Fig. 14.

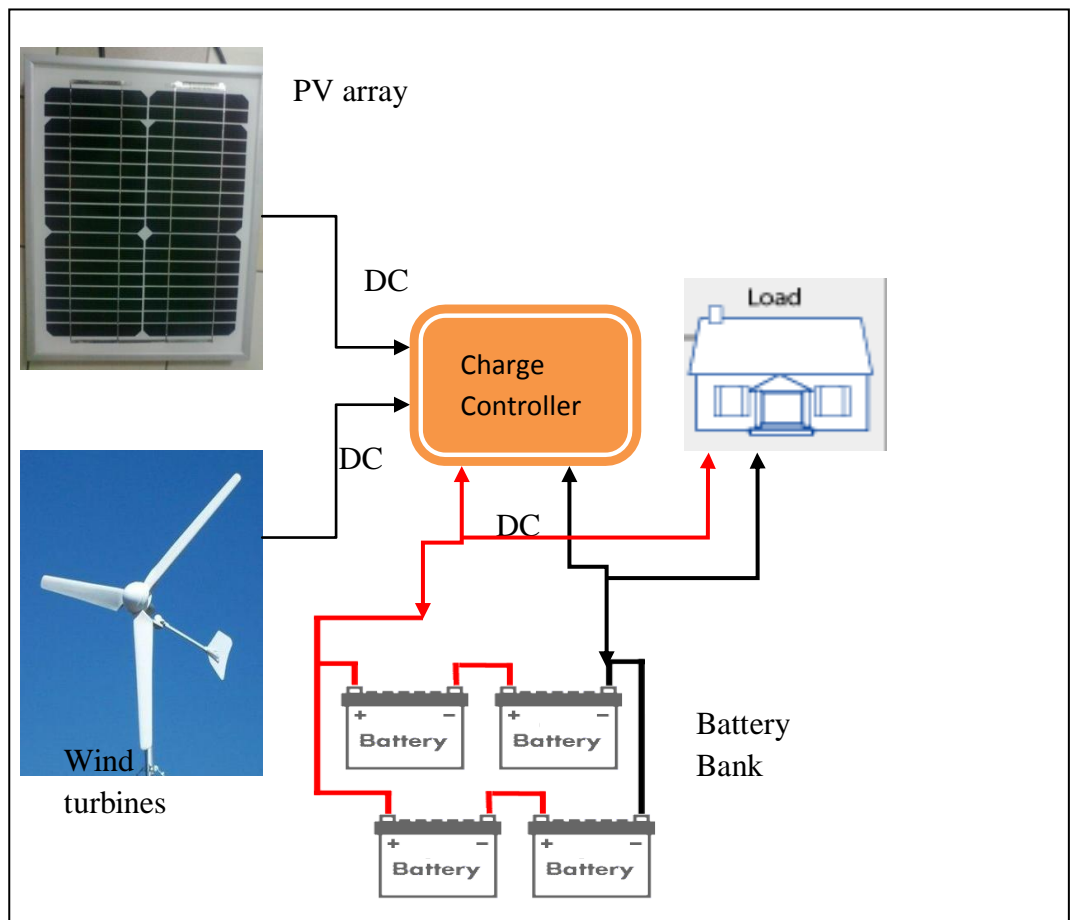

Figure 14: Layout of W_Select

Experiments were carried out for solar panel and wind turbine to analyse the performance of both of the power generators.

4.2 Electrical Load Analysis

In this project, the estimation of power consumption in a suburban household is calculated as shown in the Table 7 below:

Table 7 : Typical Power Consumption of Suburban Household

ITEMS	kW	No. of units	Peak load	Hours per day	Hrs/yr	KWh per day	kWh per year
Refrigerator	0.065	1	0.065	24.00	8760.00	1.56	569.40
Rice Cooker	0.650	1	0.650	0.70	255.50	0.46	166.08
Water Heater	1.200	1	1.200	1.00	365.00	1.20	438.00
Fan	0.045	3	0.135	8.00	2920.00	1.08	394.20
Iron	1.100	1	1.100	0.30	109.50	0.33	120.45
Hair Dryer	1.000	1	1.000	0.10	36.50	0.10	36.50
Washing Machine	0.600	1	0.600	0.20	73.00	0.12	43.80
Television	0.060	1	0.060	3.00	1095.00	0.18	65.70
Radio	0.013	1	0.013	3.00	1095.00	0.04	14.24
Air Conditioner	0.800	1	0.800	8.00	2920.00	6.40	2336.00
Fluorescent Lamps 18w	0.032	5	0.160	5.00	1825.00	0.80	292.00
Total	5.565	13	5.783	53.30	19454.50	12.26	4476.36

The calculations for a suburban residential area are:

Number of houses = 100

Estimated consumption = 4,500 kWh/year

Total estimated consumption = 4,500 kWh/year x 100
= 450 MWh/year

In case of increase of load and power consumption, the estimated power consumption of the suburban residential area would be 500 MWh/ year.

4.3 The Capacity of W_Select

Peak Load could be obtained as below:

$$\begin{aligned} \text{Peak Load} &= 5.783\text{kW} \times 100 \\ &= 578.3\text{kW} \end{aligned}$$

According to the World Bank, the electric power transmission and distribution loss in Malaysia is 4% in year 2009 [32]. Assume that the percentage of transmission losses in the suburban is the same as the percentage in Malaysia.

$$\begin{aligned} \text{The total capacity of power needed} &= 578.3 \text{ kW} \times 104 / 100 \\ &= 601.432 \text{ kW} \end{aligned}$$

4.4 Solar Power

An experiment was carried out to collect the data of power generated by a 10W photovoltaic panel from 7am until 2.30pm. Pasco data acquisition unit is used to measure the voltage generated by the panel.

The graph below shows the power generated by the photovoltaic panel. The data shows that PV panel in lower sunlight will generate lower electricity. The power generated is inconsistent due to the clearness of the sky.

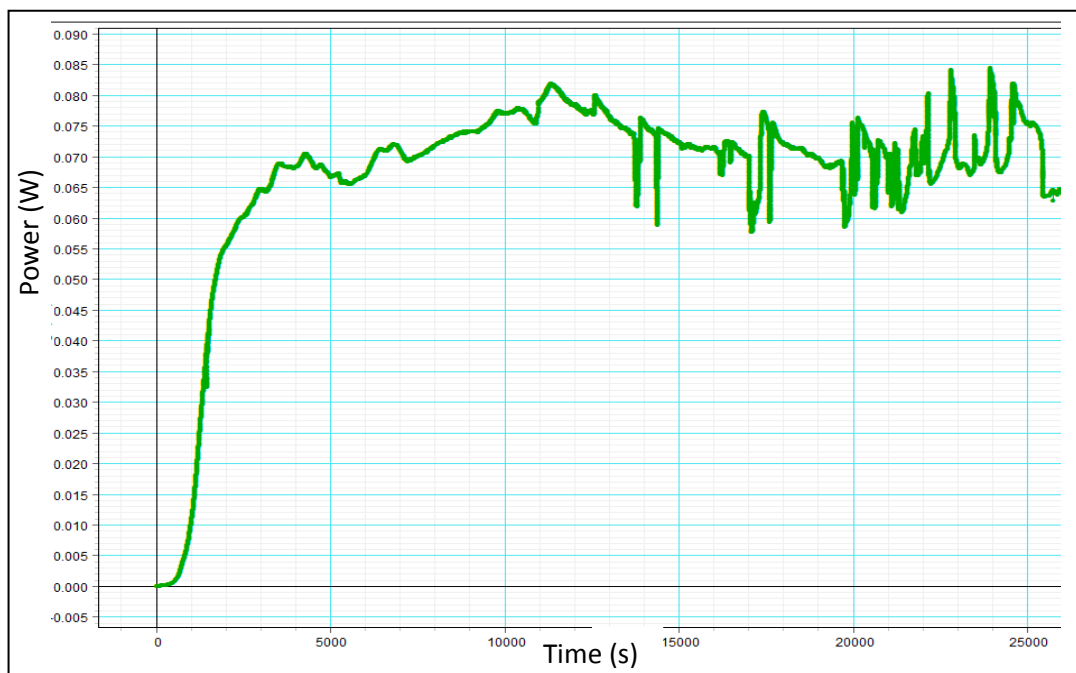

Figure 15: Graph of Power generated

4.5 Comparison of Wind Turbine Designs

Vertical axis wind turbine (VAWT) is chosen in this project because, VAWT has more benefits than Horizontal axis wind turbine (HAWT). VAWT theoretically needs less maintenance due to lesser and slower moving parts. VAWT also has less noise since tip speed is lower and no air compression from blades. Besides, VAWT can has lower rotational speed and no need of yaw control, which are good points for a location with low speed wind and constantly changing wind direction [23]. VAWT is seen as a better option since Malaysia has low average wind speed of 3 m/s and the wind blows from different directions.

4.5.1 Wind Turbine Design A

This wind turbine uses aluminium sheet to create a drag turbine. All of the blades surfaces are covered up. The turbine is shown as the Fig. 16. From the figure, it is shown that the blades of the wind turbine consist of 2 parts, which are the inner part and the outer part.



Figure 16: Wind Turbine Design A

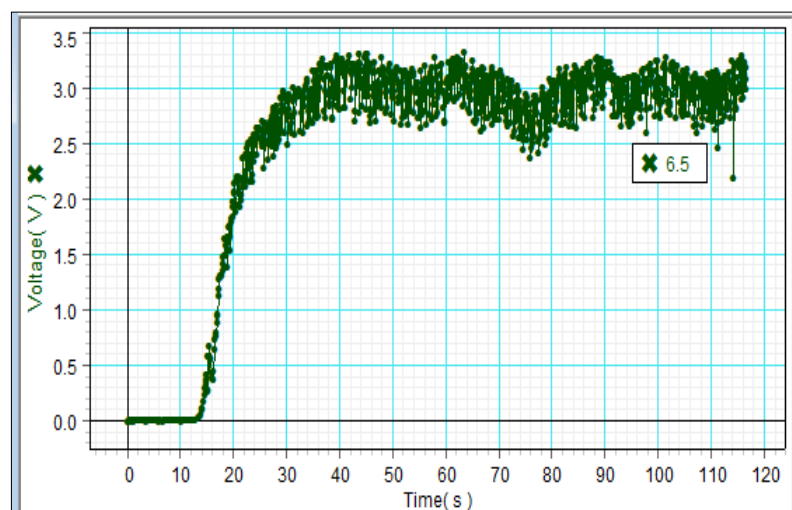

Figure 17 : The Voltage Produced by Wind Turbine Design A at 6.5m/s Wind Speed

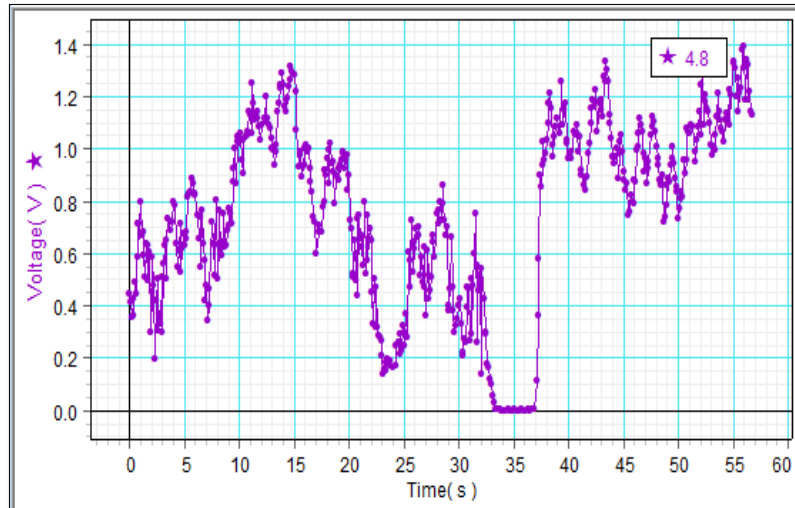

Figure 18: The Voltage Produced by Wind Turbine Design A at 4.8m/s Wind Speed

Fig. 17 shows that the wind turbine needs some time to kick off to rotate the wind blades and continue to produce a round 3V. Fig 18 shows that the rotor can spin at 4.8 m/s but slows down or stops from time to time. Fig. 17 and Fig. 18 show that wind turbine design A can generate electricity at high wind speed. However, it cannot rotate smoothly to generate electricity at 4.8 m/s which is a lower wind speed, due to heavy blades.

4.5.2 Wind Turbine Design B

In wind turbine design B, the outer parts of the blades are removed. Hence, the diameter of the turbine is reduced. In the experiments, the turbine is unable to rotate due to the decrease of torque as length of the blades is reduced.



Figure 19: Wind Turbine Design B

4.5.3 Wind Turbine Design C

In wind turbine design C, the inner parts of the blades of wind turbine design A is removed.



Figure 20: Wind Turbine Design C

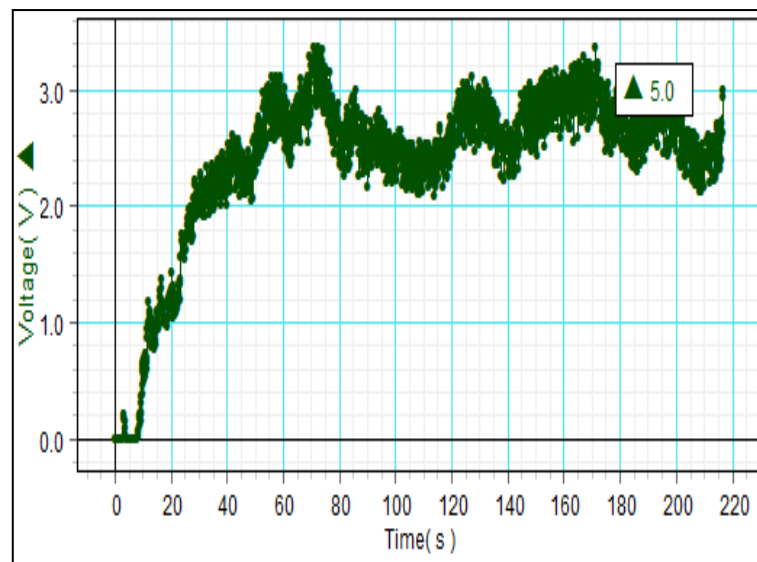

Figure 21: The Voltage Produced by Wind Turbine Design C at 5.0m/s Wind Speed

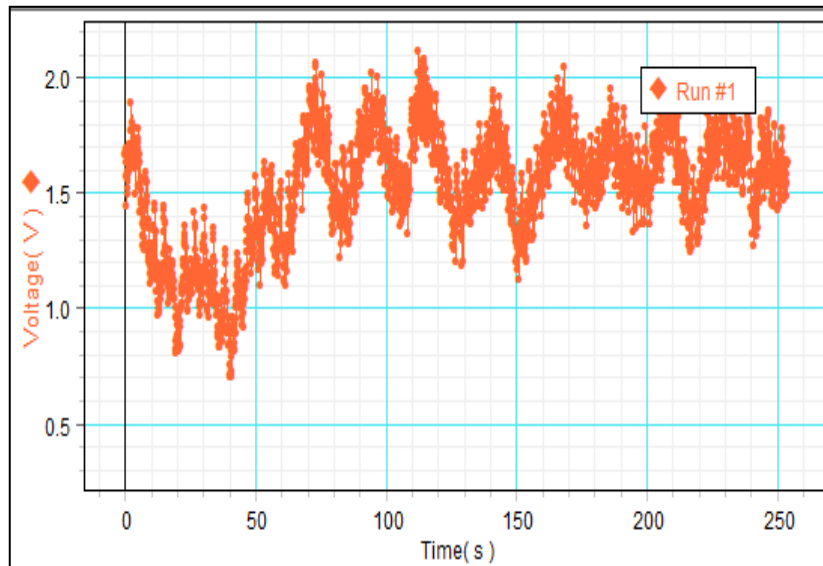

Figure 22: The Voltage Produced by Wind Turbine Design C at 4.2m/s Wind Speed

Fig 21. shows that wind turbine design C is more efficient than wind turbine design A. At wind speed 5.0 m/s, it can produce voltage as high as wind turbine design A at 6.5m/s. Besides, Fig. 22 shows that wind turbine design C at 4.2 m/s is able to produce electricity with higher voltage than wind turbine design A at 4.8 m/s. Besides, wind turbine design C can rotate smoother at lower wind speed. This is because the reduction of the weights of the blades after removing the inner part of the blade.

4.6 The Prototype of W_Select

The figure 23 below shows the prototype of W_Select, it consist of a 20W solar panel, a VAWT, blocking diodes, charge controller and a 12V battery. In figure 24, it shows the arrangement of the components for the prototype. Blocking diodes are connected between the charge controller and the two power sources to prevent reverse charging between the sources. This is because when two sources with different voltage is connected in parallel, the source with higher voltage will charge the source with lower voltage and causes current flow that could damage the source with lower voltage. Besides, blocking diode is also used to block battery from

providing current to the wind turbine [33]. Wind generator operates both ways, it will generate electricity by rotating the generator but when electricity is supply to the generator, it will spin the rotor. Therefore, blocking diode is important to prevent wind turbine from spinning wildly or even damaged.



Figure 23: Prototype of W_Select

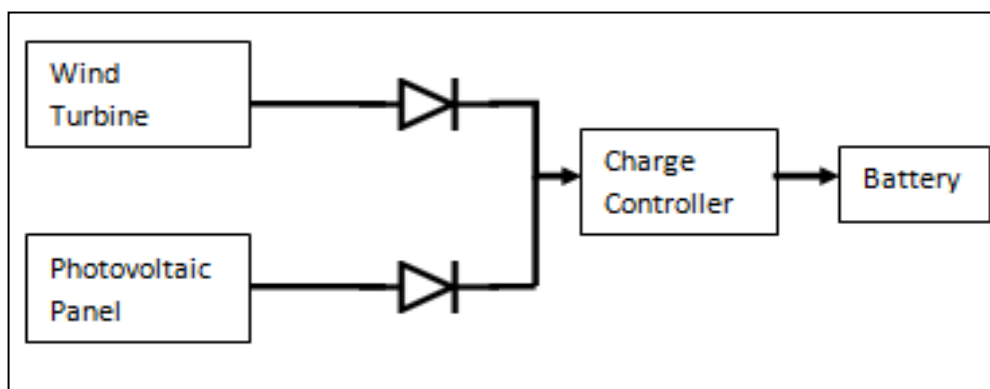

Figure 24: Arrangement of W_Select

4.7 Performance of W_Select

Experiments are performed to test the performance of W_Select. In W_Select, a PV panel of 20W/12V with rated voltage 17.28V and rated current 1.16A is used. Besides, Wind turbine design C is used since it has the highest efficiency compared to the other two options. PV panel is tested by using a 500W halogen spotlight to simulate sunlight, while wind turbine is tested by using an industrial fan to produce wind. An anemometer is used to measure the wind speed near towards the wind turbine.

Table 8: Performance Of W_Select At Different Wind Speed

Wind Speed (m/s)		4.3	4.6	4.8	5.0
Solar Panel	<i>Average Voltage (V)</i>	13.11	13.13	13.12	13.07
	<i>Average Current (A)</i>	0.184	0.183	0.177	0.171
	<i>Average Power (W)</i>	2.412	2.403	2.322	2.235
Wind Turbine	<i>Average Voltage (V)</i>	1.37	2.24	2.45	2.69
	<i>Average Current (A)</i>	0.403	0.547	0.570	0.717
	<i>Average Power (W)</i>	0.552	1.225	1.397	1.929
Combined at Charge Controller	<i>Average Voltage (V)</i>	12.46	12.48	12.47	12.44
	<i>Average Current (A)</i>	1.00	1.00	1.00	1.00
	<i>Average Power (W)</i>	12.46	12.48	12.47	12.44

The charge controller has limited the voltage of solar panel to be around 13V to prevent battery from overcharging. When the spot light is not ON, with wind turbine turning at 4.2 wind speed, the combined voltage at the charge controller is measured as 12.36V. Therefore, the voltage after combining both power sources is the same as the voltage of the battery. The voltages of the both sources is stabilised by the battery connected by the charge controller. In that way, stable DC power can be supplied to the load by the battery. Since the solar energy simulated by the spotlight is constant, therefore, the power of the solar panel is almost constant. The power of the wind turbine increases as the wind speed increases.

4.8 The Power Obtained from W_SELECT

When the parallel solar panel and wind turbine with blocking diode disconnected to the charge controller and the battery, the maximum voltage of the combined sources should be based on the source with higher voltage. However, there is back-biased voltage due to the internal resistance of the sources. It is proven by two experiments, where the first with solar panel as higher voltage source and the second with wind turbine as the higher voltage source.

Table 9: COMPARISON OF TWO EXPERIMENTS

Experiments	Solar	Wind	Combined
	<i>Average Voltage(V)</i>	<i>Average Voltage (V)</i>	<i>Average Voltage (V)</i>
1	18.23	2.57	17.64
2	0.88	2.18	1.69

According to the comparison shown in Table 7, the average total voltage of the solar panel and wind turbine in parallel is slightly less than the highest voltage source. The difference is 0.59V in experiment 1 and 0.49V in experiment 2.

The total current of parallel sources is the summation of all currents. Therefore, the power of both solar panel and wind turbine combined is calculated by multiplying the highest voltage and the summation of the current of both power sources.

4.9 Analysis Using Homer Software

Homer software is used to design and analyze hybrid power system. Homer is used in this project to analyze the power that is able to be produced by the hybrid solar and wind electricity generating system. The characteristics of the solar panel and wind turbine from the previous experiments are inserted in the software.

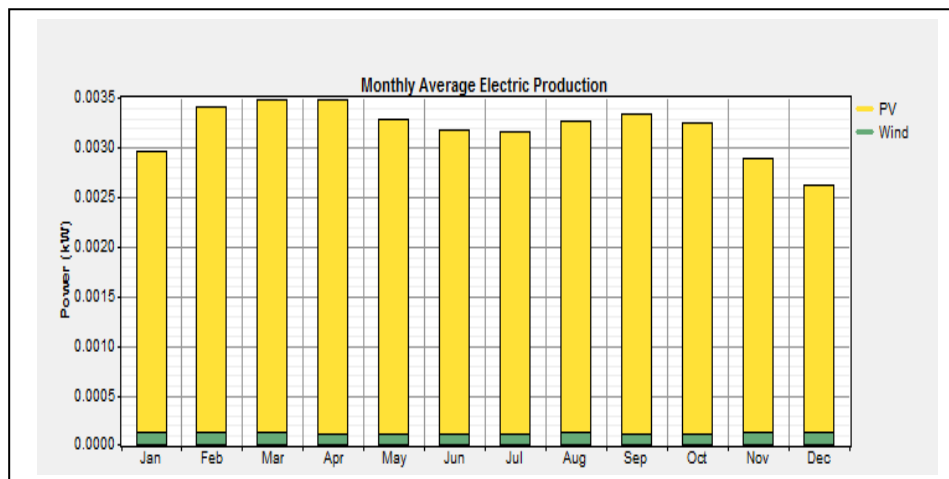

Figure 25: Monthly Average Electric Production

Fig. 25 is generated by using the data gathered from the experiments of W_Select. Fig. 25 shows the estimated monthly average electricity production of W_Select at latitude 4.38 N, longitude 100.97E. The electricity can be obtained from the wind turbine is only 4% of the total electricity production. Therefore, wind turbine of higher efficiency needs to be used to increase the electricity production from wind turbine.

4.10 The Software for W_Select

This software is built by using Microsoft Visual Basic 2010 to help to calculate the requirement of solar panels and wind turbines to achieve the daily energy requirement. This software is constructed according to the performance analysis of solar panel and wind turbine of W_Select, where wind turbine are contributing 10 % of the total electricity generation with power coefficient 0.04424. The coding of the software is shown in Appendix A.

The user can enter the daily energy requirement, sunlight hours, mean wind speed, the type of panel and the number of wind turbine to calculate the number of solar panels needed, and the diameter and height of wind blades. The figure 26 below shows the parameters of W_Select prototype, which has a 20W solar panel and a wind turbine of 0.5m x 1.0m.

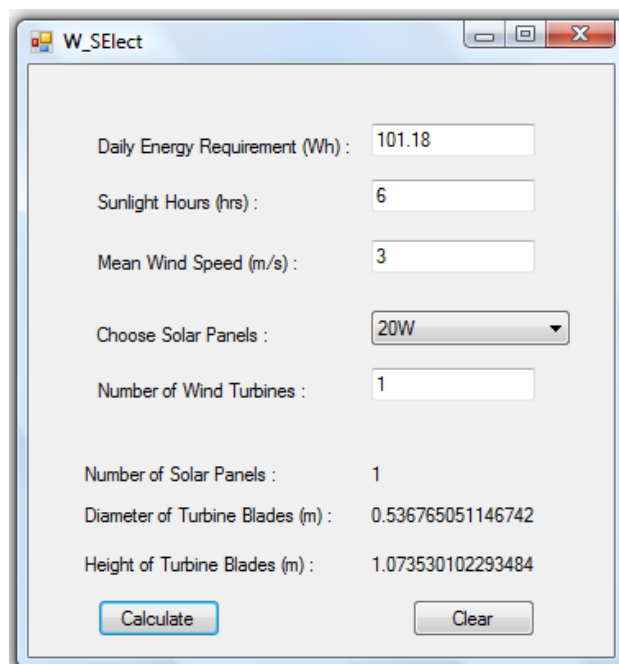
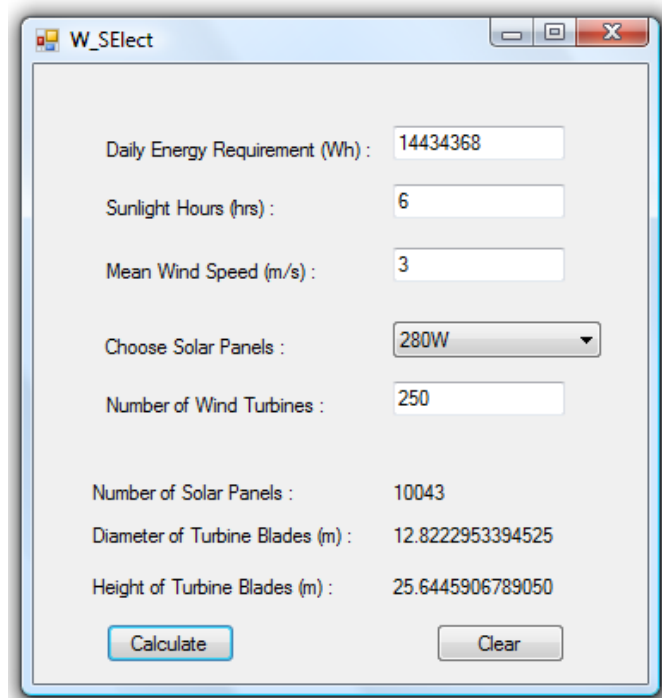

Figure 26: Example 1 of W_Select Software

The figure 27 below shows the parameters of the solar-wind hybrid generating system needed for suburban usage discussed in section 4.3. In Section 4.3, the suburban area was assumed to have 100 houses, with total power needed as 601.432kW. Therefore, the daily energy requirement of the suburban area is 601.432 kW x 24 hours, which is 14434.368kWh. The software has generated the answer of the number of solar panels needed to produce 90% of total electricity and the required diameter and height of turbine blades.



The screenshot shows a software window titled "W_Select" with the following parameters and results:

Parameter	Value
Daily Energy Requirement (Wh) :	14434368
Sunlight Hours (hrs) :	6
Mean Wind Speed (m/s) :	3
Choose Solar Panels :	280W
Number of Wind Turbines :	250
Number of Solar Panels :	10043
Diameter of Turbine Blades (m) :	12.8222953394525
Height of Turbine Blades (m) :	25.6445906789050

Buttons: Calculate, Clear

Figure 27: Example 2 of W_Select Software

CHAPTER 5

CONCLUSION AND RECOMMENDATIONS

5.1 Conclusion

In conclusion, this final year project is completed successfully. All of the objectives of this project were met. A viable renewable energy based electricity-generating system is designed, which is W_Select. The performance of the integrated solar-wind hybrid system was analysed and a software for the integration of solar-wind electricity is developed. In this project, it is proven that solar-wind electricity generating system is a good implementation of renewable energies. Solar energy is suitable for this country since Malaysia has abundance sunlight all year round. However, experiment has also proven that power generated by PV panel fluctuates and no electricity produced when no sunlight. Therefore, wind electricity is added as an alternative in the system to top off the battery bank to solve the electricity limitation of solar panel when sunlight is insufficient. Homer Software is used to analyze the total electricity capable to be produced by the W_Select at a specified location like UTP. The software has shown that the electricity from the wind turbine tested is low. Therefore, further improvement is needed in the efficiency of wind turbine.

5.2 Recommendations

Since the wind turbine is tested to have low efficiency, wind turbine with high efficiency should be used in future works. The design and the material of the wind turbine are very important in improving the efficiency of the wind turbine. The wind turbine should be able to operate at low wind speed and the material of the rotor should light but strong. Other than that, a better charge controller or two charge controllers can be used to increase the control of charging.

References

- [1] World Resources Institute. (2005). *Energy Policy in the 8th Malaysia Plan/Five Fuel Policy* [Online]. Available: <http://projects.wri.org/sd-pams-database/malaysia/energy-policy-8th-malaysia-plan-five-fuel-policy>
- [2] World Coal Association. (2012). *Where Is Coal Found?* [Online]. Available: <http://www.worldcoal.org/coal/where-is-coal-found/>
- [3] J. Twidell and T. Weir, "Solar Radiation" in *Renewable Energy Resources*, New York, USA: Taylor & Francis, pp. 85-96.
- [4] T. Wizelius, "The Power of Wind" in *Developing Wind Power Project*, UK: Earthscan, 2007, pp. 48.
- [5] BP(2011). *BP Statistical Review of World Energy June 2011* [Online]. Available: <http://www.bp.com/>
- [6] International Energy Agency. (2012). *World Energy Outlook 2011* [Online]. Available: http://www.worldenergyoutlook.org/docs/weo2011/homepage/WEO2011_Press_Launch_London.pdf
- [7] World Energy Council. (2011). *World Energy Insight 2011* [Online]. Available: http://www.worldenergy.org/documents/wec_wei2011.pdf
- [8] International Energy Agency. (2012). *2011 Key World Energy Statistics* [Online]. Available: http://www.iea.org/textbase/nppdf/free/2011/key_world_energy_stats.pdf
- [9] International Energy Agency. *Selected 2009 Indicators for Malaysia* [Online]. Available: http://www.iea.org/stats/indicators.asp?COUNTRY_CODE=MY
- [10] International Energy Agency. (2012), *Electricity/Heat in Malaysia in 2009* [Online]. Available: http://www.iea.org/stats/electricitydata.asp?COUNTRY_CODE=MY
- [11] The Government of Malaysia. "*Tenth Malaysia Plan*", Malaysia, 2012. Available: <http://www.epu.gov.my>
- [12] Energy Information Administration. "*International Energy Statistics*" [Online]. Available: <http://www.eia.gov/countries/country-data.cfm?fips=MY&trk=c#cde>
- [13] H.A. Bekhet and N.S. Othman, "*Assessing the Elasticities of Electricity Consumption for Rural and Urban Areas in Malaysia: A Non-linear Approach*", Universiti Tenaga Nasional, Malaysia, 2011.
- [14] The Government of Malaysia. "*Laws of Malaysia Act 725 Renewable Energy Act 2011*", Malaysia, 2011.

- [15] Sustainable Energy Development Authority Malaysia. (2012). *Feed-in Tariff (FiT) Rates* [Online]. Available: <http://seda.gov.my/>
- [16] Balbir Singh Mahinder Singh, Mohamad Shawari Abu Bakar, Nursyarizal Mohd Nor and Nor Athirah Zainal. “Development of Two-Axis Sun Tracking System” in International Conference on Fundamental and Applied Sciences, ESTCON 2012.
- [17] Sonia Wharton and Julie K Lundquist. Atmospheric stability affects wind turbine power collection. *Environmental Research Letters*, 2012; 7 (1): 014005 DOI: 10.1088/1748-9326/7/1/014005
- [18] GAISMA. (2002). *Solar Energy and Surface Meteorology*. Available: <http://www.gaisma.com/en/location/kuala-lumpur.html>
- [19] Angus Gemmell. (2009). *Which Solar Panel Type Best Suits Your Needs – Monocrystalline, Polycrystalline or amorphous thin film?* [Online]. Available: <http://www.solarchoice.net.au/>
- [20] M.Benghanem, “Optimization of Tilt Angle for Solar Panel: Case Study for Madinah, Saudi Arabia”, *Applied Energy*, Volume 88, Issue 4, April 2011, 1427-1433, 2011.
- [21] Malaysian Meteorological Department. (2012). *General Climate of Malaysia* [Online]. Available: <http://www.met.gov.my>
- [22] J.den Haan, (2009). *Derating Your Panels* in Solar Panels. Available: <http://www.solarpower2day.net>
- [23] S. Stankovic et al. “*Turbine Technology,*” in *Urban Wind Energy*, UK: Earthscan 2009, pp. 114-116.
- [24] Pragya Nema et al, “A current and future state of art development of hybrid energy system using wind and PV-solar: A review,” Department of Energy, Energy Centre, Maulana Azad National Institute of Technology, Bhopal 462007, M.P., India, *Renewable and Sustainable Energy Reviews* 13(2009) 2096-2103, 2008.
- [25] G. Martin and J. Roux, “*Prediction Vertical Axis Wind Turbine Behavior*” in *Wind Turbines Types, Economics and Development*, New York, USA: Nova Science Publishers, 2009, pp. 3-23
- [26] Yu Chang et al., “Lead- Acid Battery Use in The Development of Renewable Energy System in China,” in 7th International Conference on Lead Acid Batteries, Varna Bulgaria, 9-12 June 2008.
- [27] John Greenspan. *How to choose suitable batteries for your solar panels* [Online]. Available: <http://www.diysolarpanelsworld.com/>

- [28] P.C. Frost, "Developments in Lead-Acid Batteries: A Lead Producer's Perspective," Britannia Refined Metals, Northfleet, Kent, UK, *Journal of Power Sources*, Volume 78, Issues 1-2, March 1999, pp. 256-266.
- [29] Bright Green Energy. *Absorbed Glass Matt (AGM) and Gel Batteries For Renewable Energy Systems* [Online]. Available: <http://www.wirefreedirect.com/>
- [30] M. R. Patel, "Energy Storage" in *Wind and Solar Power System.*, USA: CRC Press, 2000, pp. 161-183.
- [31] J Dunlop, 2007. *Photovoltaic System.*, US: ATP Production, pp. 145-223.
- [32] The World Bank. (2011). *Electric Power Transmission and Distribution Losses (% of output)*[Online]. Available: <http://data.worldbank.org/indicator/EG.ELC.LOSS.ZS>
- [33] L. Castaner and S. Silvestre, *Power Conditioning and Inverter Modelling in Modelling Photovoltaic Systems using PSpice.*, UK: Wiley, 2002, pp. 133-174.

APPENDIX A – SOFTWARE CODING

Public Class Form1

```
Private Sub ComboBox1_SelectedIndexChanged(sender As System.Object, e As System.EventArgs)
```

```
End Sub
```

```
Private Sub ComboBox1_SelectedIndexChanged_1(sender As System.Object, e As System.EventArgs)
```

```
Handles ComboBox1.SelectedIndexChanged
```

```
End Sub
```

```
Private Sub Label2_Click(sender As System.Object, e As System.EventArgs)
```

```
Handles Label2.Click
```

```
End Sub
```

```
Private Sub btnCalc_Click(sender As System.Object, e As System.EventArgs)
```

```
Handles btnCalc.Click
```

```
Dim intNum1, intNum2, intNum3, intSolar, intDia, intHeight As Decimal
```

```
Dim intNum4 As Integer
```

```
intNum1 = Val(txtNum1.Text)
```

```
intNum2 = Val(txtNum2.Text)
```

```
intNum3 = Val(txtNum3.Text)
```

```
intNum4 = Val(txtNum4.Text)
```

```
Select Case ComboBox1.SelectedIndex
```

```
Case 0
```

```
intSolar = intNum1 * 90 / 100 / intNum2 / 0.77 / 20
```

```
Case 1
```

```
intSolar = intNum1 * 90 / 100 / intNum2 / 0.77 / 50
```

```
Case 2
```

```
intSolar = intNum1 * 90 / 100 / intNum2 / 0.77 / 90
```

```
Case 3
```

```
intSolar = intNum1 * 90 / 100 / intNum2 / 0.77 / 185
```

```
Case 4
```

```
intSolar = intNum1 * 90 / 100 / intNum2 / 0.77 / 200
```

```
Case 5
```

```
intSolar = intNum1 * 90 / 100 / intNum2 / 0.77 / 280
```

```
End Select
```

```
intDia = (intNum1 * 10 / 100 / 0.5 / 1.225 / 2 / intNum3 / intNum3 / intNum3 /  
0.04424 / intNum4 / 24) ^ (1 / 2)
```

```
intHeight = 2 * intDia
```

```
intSolar = -Int(-intSolar)
```

```
lblSolar.Text = intSolar
```

```
lblDia.Text = intDia
```

```
lblHeight.Text = intHeight
```

```
End Sub
```

```
Private Sub btnclear_Click(sender As System.Object, e As System.EventArgs)
Handles btnclear.Click
    txtNum1.Clear()
    txtNum2.Clear()
    txtNum3.Clear()
    txtNum4.Clear()

    lblDia.Text = "?"
    lblHeight.Text = "?"
    lblSolar.Text = "?"

    ComboBox1.SelectedIndex = -1
End Sub

Private Sub Form1_Load(sender As System.Object, e As System.EventArgs)
Handles MyBase.Load

    End Sub
End Class
```