

CHAPTER 1 : INTRODUCTION

1.1. BACKGROUND STUDY

Water served an essential substance in our everyday life. It represents 70% of our whole body composition and also 70% of the earth's surface. This kind of statistical values signifies the importance of water as a crucial material in continuing life. In industrial application, water is being used as a heat transfer medium in order to regulate temperature of raw materials before entering other reactions or processes. Cool or hot water is used in heat exchangers mostly for heat transfer process while steam on the other hand, are used for line purging or cleaning purposes. Therefore, a continued supply of cool water is essential to ensure the efficiency and also the availability of the equipment—and to achieve this objective, the specific equipment must operate properly with according to their respective operating temperature since the raw material must undergo the cooling or heating process in a heat exchanger before heading towards the stated equipment. When supply of water is disrupted, major problems will occur inside the equipment and thus affecting the reliability and also the operational flow of the industrial plant.^{[1][2]}

To assess the reliability of the cooling water system, one of the famous methods that can be utilized is the Fault Tree Analysis (FTA). FTA analysis is a failure analysis method in which an undesired state of a system is analyzed with the objective of determining the probability of the system failure.

This study emphasizes on the FTA of the cooling water system failure due to cutoff of electrical supply. To add relevancy value towards the project, the author will implement the failure distributions into the basic events of the FTA so that the resultant result will be easily quantify and justify. The analysis is developed in Microsoft Excel 2010 to diverse the application of FTA as the spreadsheet software is widely available and compatible regardless of geographical boundary compared to other software that are available in the market now. Therefore, it can be implemented anywhere for any use regarding reliability aspect.

1.2. PROBLEM STATEMENT

Continuation supply of cooling water in an industrial plant is one of the key points in maintaining a good stream of finished products. It is because cooling water controls and regulates the temperature of raw materials before they are heading into a reaction or a process. Failure or disruption in the supply of cooling water will leads to a much bigger problem to the plant. The main problem that the author tackles in this project is the disturbance in cooled water supply during a power outage.

Analytical software that can analyze these problems can be found in the market today. However, software's manufacturers imply a high amount of fees for the license in order for the software to be used and utilized. Therefore, there is a need of compatible, widely available and inexpensive software for FTA analysis in order to analyze an uncomplicated system.

1.3. OBJECTIVES

The objectives of this project are:

1. To develop a Quantitative Fault Tree Analysis for failure of cooling water supply due to electrical power outage.
2. To develop the said Fault Tree Analysis in Microsoft Excel 2010.
3. To apply statistical distributions on the values of the Fault Tree Analysis for a diverse application.
4. To validate the results obtained by in the proposed spreadsheet model with the results from BlockSim 8.

1.4. SCOPE OF WORK

In this project, the scope of work is defined below :

1. The Piping and Instrumental Diagram (P&ID) of the cooling water supply system is obtained from a case study in the Internet.
2. The resulting Fault Tree Analysis is developed from the P&ID.
3. The probability of failure is calculated and simulated with respect to three statistical distributions, which are lognormal distribution, exponential distribution and 2-parameter Weibull distribution.
4. The resulted values are validated using BlockSim 8 software.

CHAPTER 2 : LITERATURE REVIEW

This section of the proposal will show the ample amount of study done by the author in preparing for this project. Sources of literature review vary from books, journals, and the Internet. Sources are then filtered and the best results are posted here and the others are kept for future reference.

2.1. FAULT TREE ANALYSIS

In an event of a failure, analyst will gather all the data of the failure and will developed an analysis based on the data taken. Data can be presented in many ways, and with that engineers will develop full analysis regarding the event. It covers the failures and causes of failures. In handling such data, proper way of presenting can avoid confusion and increasing the efficiency of the analysis. One of the tools used is the Fault-Tree Analysis.

2.1.1. UNDERSTANDING FAILURES

Failure occurs when an equipment has suffered incapability to perform one or more of its designed functions. It is also defined that an equipment does not need to be completely disable for it to suffer failure. Failures can be contributed by problem in the raw materials itself, or problem that rooted during the manufacturing and/or assembly stages, or problem cause when it operates out of its design parameters, or just a course of nature. Justification in why failure occurs will lead to improvement of equipment life and prediction of the next failure event to occur.^[3]

2.1.2. FAILURE ANALYSIS

Failure analysis is the process of collecting and analyzing data to determine the cause of a failure. It is an important discipline in many branches of manufacturing industry, such as the electronics industry, where it is a vital tool used in the development of new products and for the improvement of existing products. It relies on collecting failed components for subsequent examination of the cause or causes of failure using a wide array of methods, especially microscopy and spectroscopy. The NDT or nondestructive testing methods are valuable because the

failed products are unaffected by analysis, so inspection always starts using these methods.^{[4][5]}

2.1.3. FAULT TREE ANALYSIS

Fault Tree Analysis is a graphical interpretation of the combinations of possible causes that contribute to a failure event of an item or a system. The causes are connected through Boolean logic gates, mainly the AND and OR gates. The input events passing through the AND gate are necessary but not sufficient and should occur simultaneously to produce the output event. Any one of the input events passing through an OR gate is sufficient to produce the output event of that gate. An AND gate increases the size of a branch of the fault tree whereas the OR gate increases the number of branches. The analysis starts at the top and goes downward until the most basic failure is identified. The tools emphasizes on a single worse undesired event and will provide the analyst on how the event can occur and what results it leads to and at the same time allowing the analyst to identify all the components which play a major role in defining the system failure.^{[6][7]}

2.1.4. DEVELOPMENT OF FAULT TREE ANALYSIS

In developing fault-tree analysis, several concepts need to be taken into accounts. The concepts will ensure the analysis produced is not too redundant or too confusing. Several concepts of fault-tree analysis are :

1. The fault-tree analysis is a tool that emphasizes on a single worse undesired event. It is an event of worst-case scenario in which to be prevented at all cost. The system can fail to do what it is supposed to do; the system can do something it is intended to do but at the wrong time; or the system can do what it was designed to do but in some out-of-specification manner. The failure analysis team should define the fault-tree top undesired event to be consistent with the problem definition.
2. Fault-tree analysis does not evaluate all potential failure modes of all parts. But the fault-tree analysis considers all these modes which include form human error, manufacturing error, structural error, assembly error and others.



Advantage of the fault-tree analysis apart from other analysis is that by considering all the modes of failures, it widens the aspect of how an undesired event can occur. By taking consideration of all aspects, engineers and analysts can tackle the problem down to the root.^[7]

2.1.5. GRAPHIC SYMBOLS IN FAULT TREE ANALYSIS

A Fault Tree Analysis by definition is a graphical interpretation of possible events that led up to a failure event. In developing the analysis, analysts gather information and arrange the data in event symbols and connect them via Boolean logic gates as shown in Table 2.1.^[8]

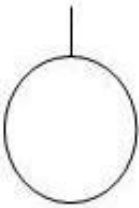
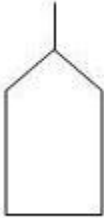
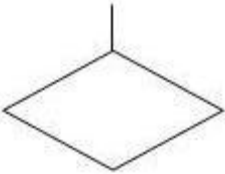
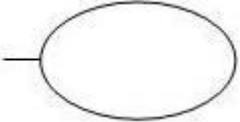
Table 2.1: List of logic gates applied in fault tree analysis

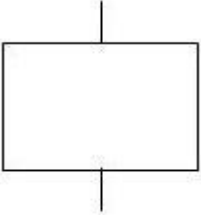
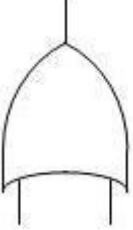
	<p>1. Basic event symbol</p> <ul style="list-style-type: none"> • Failure or error in a system component or element.
	<p>2. Initiating event symbol</p> <ul style="list-style-type: none"> • An external event that took place that affects the system.
	<p>3. Undeveloped event symbol</p> <ul style="list-style-type: none"> • An event about which insufficient information is available, or which is of no consequence.
	<p>4. Conditioning event symbol</p> <ul style="list-style-type: none"> • Conditions that restrict or affect logic gates.

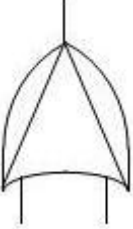
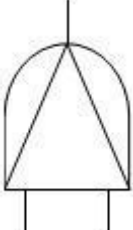
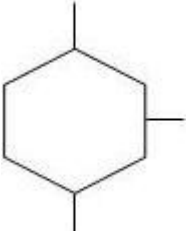
	<p>5. Intermediate event gate</p> <ul style="list-style-type: none"> • Can be used immediately above a primary event to provide more room to type the event description.
	<p>6. OR gate</p> <ul style="list-style-type: none"> • Output will occur if any inputs listed occur.
	<p>7. AND gate</p> <ul style="list-style-type: none"> • All of the independent inputs must occur for the resulting output to occur.
	<p>8. XOR (Exclusive OR) gate</p> <ul style="list-style-type: none"> • Output occurs if and only if one specified input occurs in the sequence.
	<p>9. Priority AND gate</p> <ul style="list-style-type: none"> • Output occurs if the inputs occur in a specific sequence specified by a conditioning event.
	<p>10. Inhibit gate</p> <ul style="list-style-type: none"> • Output occurs if the input occurs under an enabling condition specified by a conditioning event.

2.1.6. QUANTITATIVE ANALYSIS

In Fault Tree Analysis, each block represents an event that sooner or later will contribute to the failure of the whole system. Each of the blocks also has their own failure rate, rate in which the failure will occur in time. Quantitative analysis of the Fault Tree Analysis applies the statistical and probability calculation to figure out the reliability and the probability of failure of the event/component. The quantitative analysis of the Fault Tree Analysis also depends on failure data to calculate the failure rate and is restricted to other limitations. Applicable formulas are shown to describe the calculation process of Fault Tree Analysis.^[9]

$$\text{Reliability, } R = \frac{\text{Success}}{\text{Success} + \text{Failure}}$$

$$\text{Probability of Failure, } P_f = \frac{\text{Failure}}{\text{Success} + \text{Failure}}$$

Always remember that $R + P_f = 1$

In the OR gate connection, where only when either one or all of the subsequent failures occur will contribute to the system failure;^[9]

$$\text{Total Reliability, } R_t = R_a R_b$$

$$\text{Total Probability of Failure, } P_{f,t} = P_{f,a} + P_{f,b} - P_{f,a} P_{f,b}$$

In the AND gate connection, where only when all of the subsequent events occurs will contribute to the system failure;^[9]

$$\text{Total Reliability, } R_t = R_a + R_b - R_a R_b$$

$$\text{Total Probability of Failure, } P_{f,t} = P_{f,a} P_{f,b}$$

2.1.7. LIMITATIONS

In all failure analysis, there are always limitations with an analytical tool that can either constrict or enhance the effectiveness of the tool. In Fault Tree Analysis, the analysis can only be done on a non-repairable system. Non-repairable system is defined by a system that failed and it cannot be repaired or altered back towards its original condition. Human factors or sabotages are also another limitation to Fault Tree Analysis. Human factor is an unsolved factor that cannot be predicted by any tool and the outcome of the factor may be vary and thus unspecific. Fault Tree Analysis also limit on an item that only poses a constant rate of failure, which mean that the failure can be predicted that it might occur again within certain timeframe.^[9]

2.2. COOLING WATER SYSTEM

Water cooling has been used as a method of heat removal from components and equipment in industrial application. Comparing water cooling and air cooling system, water cooling system uses water instead of air as the heat removal medium. Water cooling system is widely found in automobile internal combustion engine and also large industry facilities such as electric power plants, hydroelectric generator, petroleum refineries and chemical plants. There are also other uses for cooling water system, more recently found in high-end personal computers. The principal method for water cooling is convective heat transfer.^[10]

In removing heat from components and equipment in an industrial plant, the cooling water system rely on two systems, either recycled through a recirculating system or used in a single pass once-through cooling system. Recirculating system depends on cooling tower or cooling ponds for water supply (open system), or it is accomplished with negligible evaporative loss of cooling water (closed system).^[10]

Advantages of applying the cooling water system are that water is inexpensive, widely available and non-toxic. In comparison to cooling air system is that water has higher specific heat capacity, density, and thermal conductivity. This will increase the efficiency of the cooling system as water allows for higher heat transfer over greater distance with much less volumetric flow and reduced temperature difference. However, the cooling water system also poses some disadvantages in its implementation. Bacteria, such as E-coli build up will endangers life of surrounding human and animal alike. Scales build up and corrosion in equipment helps in the likelihood of the equipment to fail. These disadvantages are overcome by applying chemical treatment to the water before being used throughout an industrial plant.^[11]

In a typical industrial plant, the cooling water system operates with supply of water coming from a seawater reservoir, or a freshwater reservoir, or both seawater and freshwater reservoir. The cooling water are distributed throughout the plant using assembly of pumps (electric-powered or diesel powered or both), valves and pipes. This assembly can be interpreted on a Piping and Instrumental Diagram

(P&ID) as shown in **Figure 2.2**. From the P&ID, the Fault Tree Analysis can be developed.^[12]

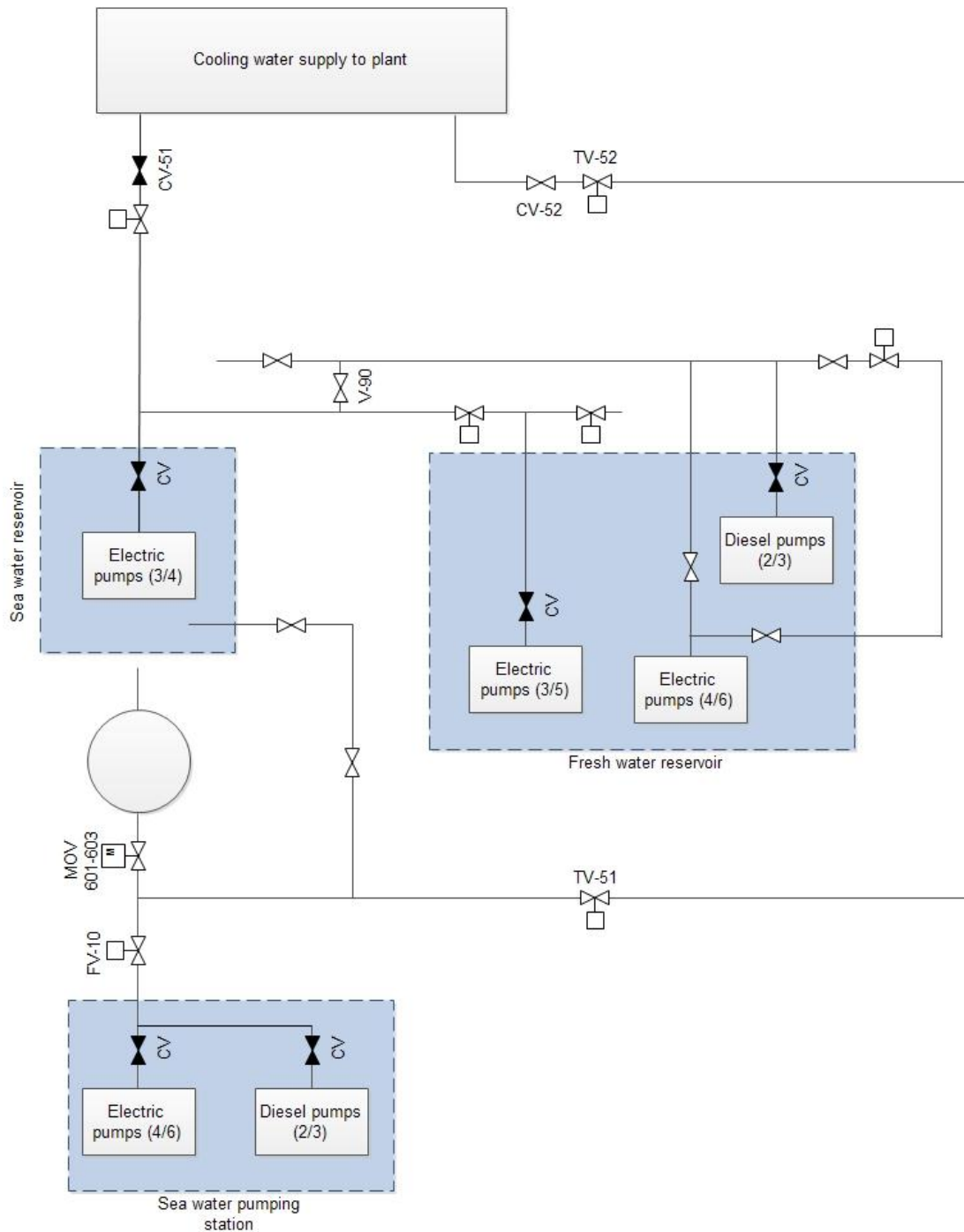

Figure 2.2 : The simplified process and instrumentation diagram of cooling water system using freshwater and seawater reservoir^[12]

2.3. RELIABILITY ENGINEERING

Reliability engineering is an engineering field that focuses on the study, evaluation, and life-cycle management of items, components, equipment, or systems reliability. Reliability here is defined as the ability of an item, component, equipment, or system to perform its required function for a specified period of time. By theory, reliability engineering emphasizes on the probability to failure of the item, as well as the remaining life, maintenance planning and maintenance cost. The steps that a reliability engineer will undergo in doing reliability analysis are applying knowledge of non-destructive examinations to collect failure data and the data is then undertaken failure analysis such as Fault Tree Analysis. The results from these analyses will tell the reliability of a system and thus further maintenance plan can be charted to focus on the critical problem first. With proper planning, maintenance work can be done with optimum cost usage.^{[13][14][15]}

2.3.1. FAILURE DISTRIBUTION

Failure data of equipment can be obtained through non-destructive examination or destructive testing (NDT). Data from NDT can be in terms of thickness, which comes from ultrasonic thickness measurement of a vessel or temperature hotspot from a thermography scan of a boiler. After the data is obtained, engineer will revise and analyze the data to come up with remaining life calculation, corrosion rate and also the failure rate. This batch of data is considered as failure data of an equipment. However, with low risk equipment, this criterion is hard to achieve. Therefore, reliability engineers will rely on software to predict the failure probability and reliability of the equipment. These software implement the calculation of random number which mimics the failure rate of the equipment that follows certain distribution. In this project, the author focuses on three most commonly used distributions which are Weibull distribution, lognormal distribution and exponential distribution.^[16]

2.3.1.1. WEIBULL DISTRIBUTION

Weibull distribution was introduced by Waloddi Weibull in 1951 to American Society of Mechanical Engineers using seven case studies as references. Weibull distribution is widely used today in a lot of fields, mainly reliability

engineering due to its versatility. It can be described as a 3-parameters function, with beta, β (shape parameter, slope), eta, η (scale parameter, characteristic life) and gamma, γ (location parameter, location of distribution along the abscissa) or 2-parameters function, with beta, β (shape parameter, slope), and eta, η (scale parameter, characteristic life). In this project, the author will mainly focus on the application of the 2-parameters Weibull distribution. The probability density function of 2-parameters Weibull distribution is ;^{[17][18][19][20]}

$$f(t) = \frac{\beta}{\eta} \left(\frac{t}{\eta}\right)^{\beta-1} e^{-\left(\frac{t}{\eta}\right)^\beta}$$

where β is shape parameter,

η is scale parameter,

t is time to failure (in seconds or minutes or hours or years)

The integration of the probability density function will produce the cumulative density function, F(t), commonly known as the probability to failure.^[28]

$$F(t) = 1 - e^{-\left(\frac{t}{\eta}\right)^\beta}$$

where β is shape parameter,

η is scale parameter,

t is time to failure (in seconds or minutes or hours or years)

The resulting reliability of the data t, is given by :

$$R(t) = 1 - F(t)$$

Equation 2.3 : General reliability function

Beta, β , represents the shape parameter of the Weibull distribution. It is a dimensionless figure which represents the condition of the failure rate of an item under Weibull distribution. The conditions are .^[28]

$\beta < 1$ represents decreasing failure rate.

$\beta = 1$ represents constant failure rate

$\beta > 1$ represents increasing failure rate

Figure 2.3 until figure 2.6 shows on how changing these parameters will affect the probability density function curve, reliability and failure rate.

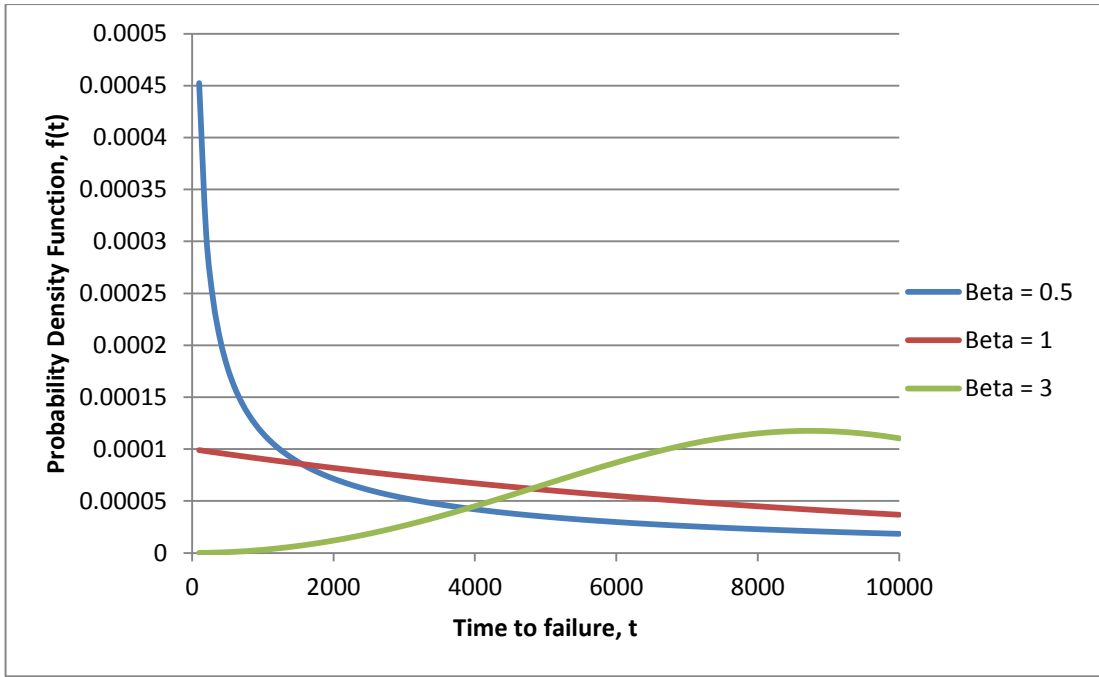

Figure 2.3 : Difference of probability density function with changing beta(Weibull distribution)

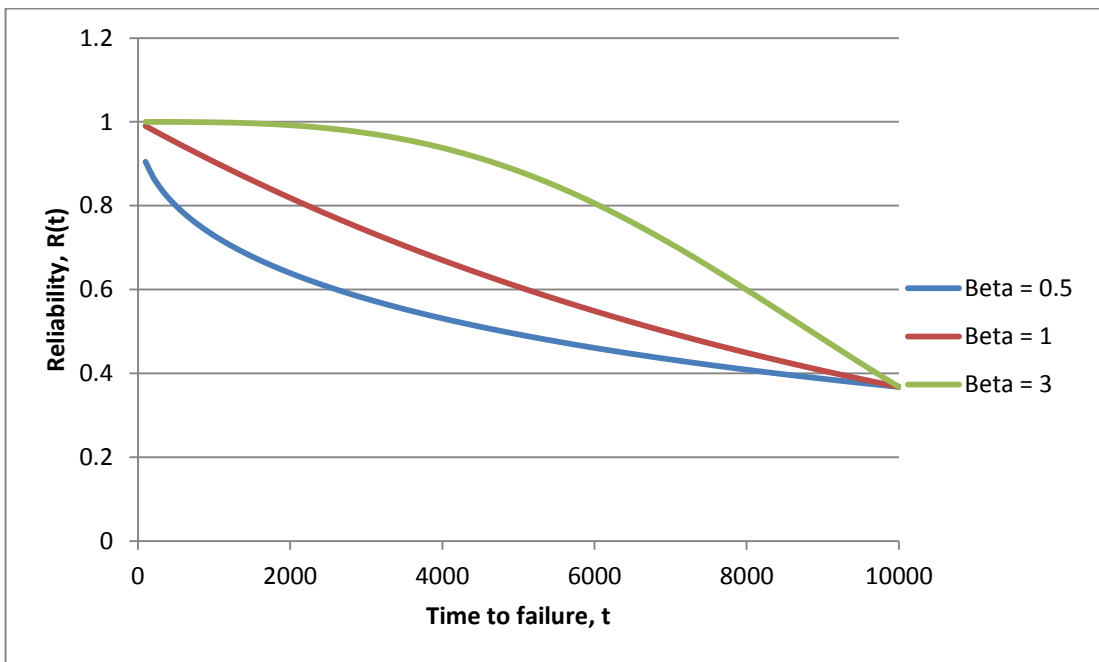

Figure 2.4 : Difference of reliability with changing beta(Weibull distribution)

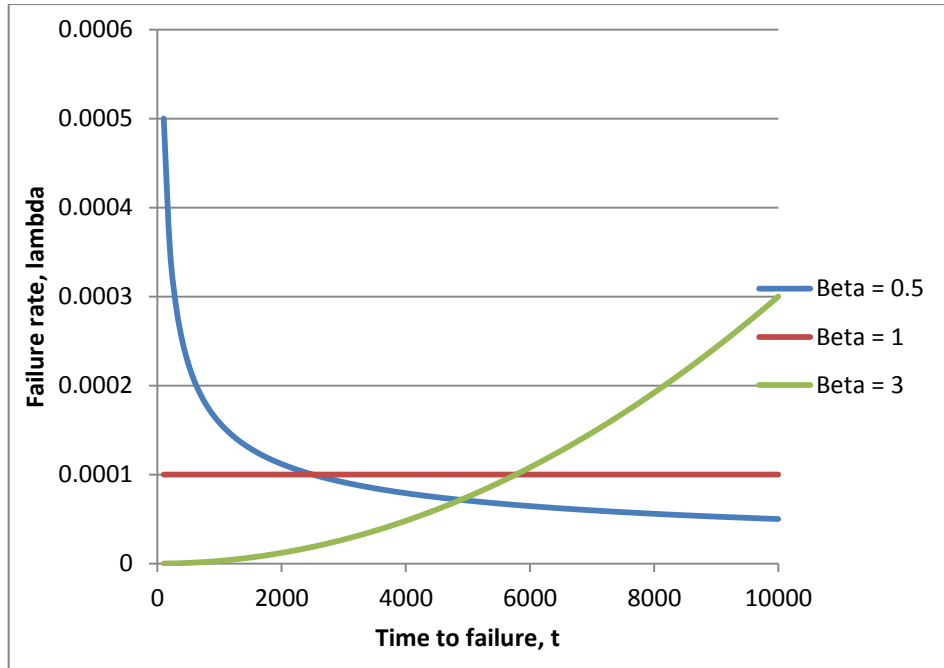

Figure 2.5: Difference of failure rate with increasing beta(Weibull distribution)

Eta, η , represents scale parameter affects the distribution characteristics such as the shape of the probability density function, the reliability and the failure rate. Eta represents which 63.2% of the population will failed. Therefore, the unit of eta is the same as the time and it can be whether seconds, minutes, hours or years.^[28]

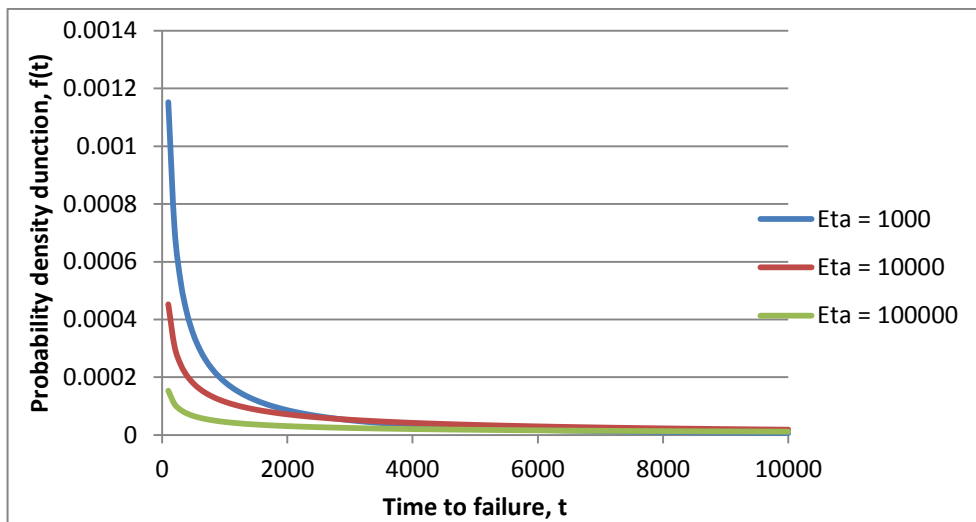

Figure 2.6 : Difference of probability density function with increasing eta(Weibull distribution)

2.3.1.2. LOGNORMAL DISTRIBUTION

In probability theory, a log-normal distribution is a continuous probability distribution of a random variable whose logarithm is normally distributed. If X is a random variable with a normal distribution, then $Y = \exp(X)$ has a log-normal distribution; likewise, if Y is log-normally distributed, then $X = \log(Y)$ has a normal distribution. The log-normal distribution is the distribution of a random variable that takes only positive real values. The data in a lognormal distribution obeys a certain mean and standard deviation and changes in these parameters will affect the shape of the lognormal probability density function curve.^{[20][25][26][27]}

The probability density function of lognormal distribution can be written down as follow :^[28]

$$f(t') = \frac{1}{\sigma' \sqrt{2\pi}} e^{-\frac{1}{2} \left(\frac{t' - \mu'}{\sigma'} \right)^2}$$

Where; t is time in seconds, minutes, hours or years,
 σ (sigma) is the standard deviation, and
 μ (mu) is the mean.

The integration of the probability density function will produce the cumulative density function or also known as the probability of failure.^[28]

$$F(t') = \frac{1}{\sigma' \sqrt{2\pi}} \int_{-\infty}^t e^{-\frac{1}{2} \left(\frac{t' - \mu'}{\sigma'} \right)^2} dy$$

Where; t is time in seconds, minutes, hours or years,
 σ (sigma) is the standard deviation, and,
 μ (mu) is the mean.

With the changes in the mean and standard deviation, it will affect the probability density function curve, the failure rate and the reliability function as shown in **figure 2.7 until figure 2.8**.

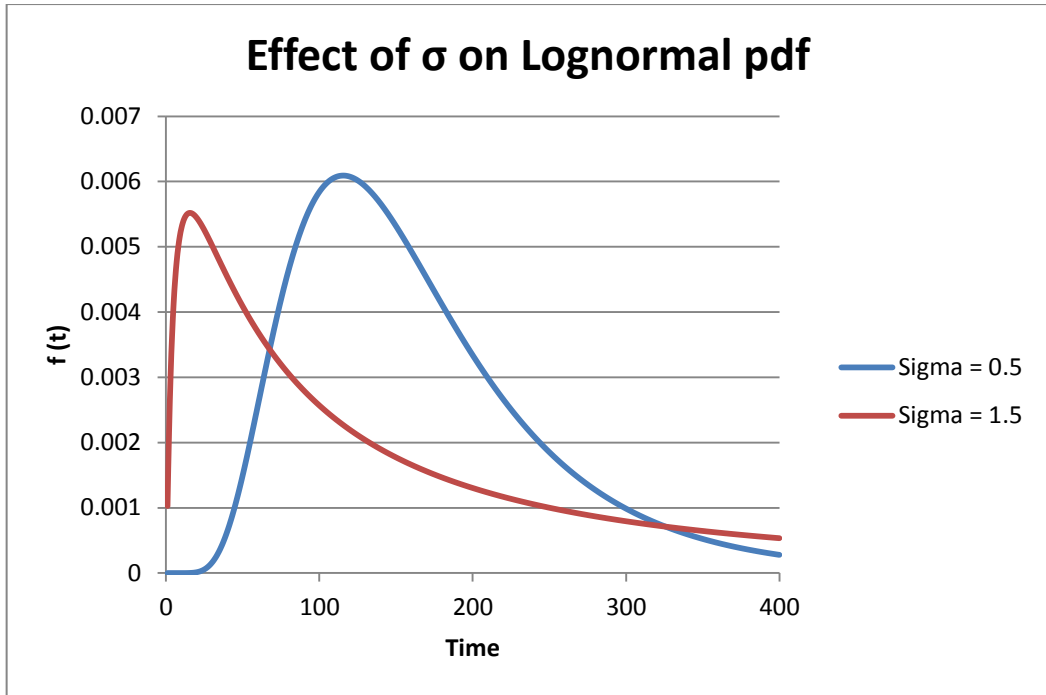

Figure 2.7 : Difference in probability density function with changing sigma(Log-normal distribution)

With increasing standard deviation, the degree of skewness of the probability density function will increase for a constant mean.

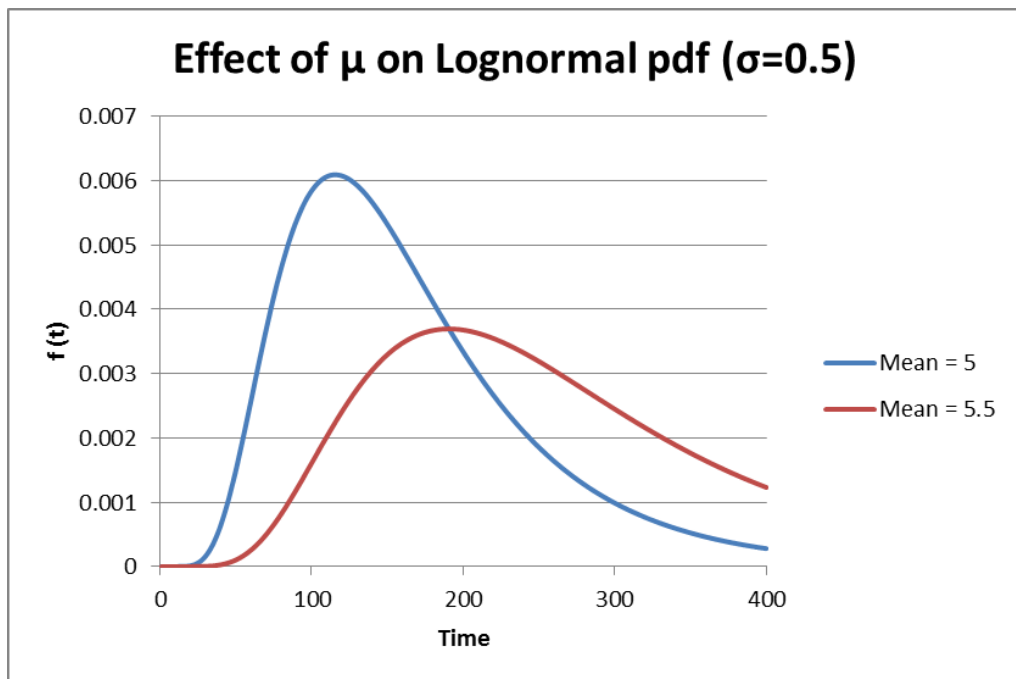

Figure 2.8 : Difference in probability density function with changing mean (Log-normal distribution)

With increasing mean, the probability density function skewness will increase with constant standard deviation.

2.3.1.3. EXPONENTIAL DISTRIBUTION

In probability theory and statistics, the exponential distribution is a family of continuous probability distributions. It describes the time between events in a Poisson process, which is a process in which events occur continuously and independently at a constant average rate. It is the continuous analogue of the geometric distribution. It is commonly used in reliability engineering analysis even though in cases which it does not apply due to its simplicity. It is described for equipment which has constant failure rate.^{[21][22][23]}

The probability density function of exponential distribution can be described as below :^[28]

$$f(t) = \lambda e^{-\lambda t} = \frac{1}{m} e^{-\frac{1}{m}t}$$

Where : λ is the equipment failure rate,

m is mean time to failure, or mean time between failure in seconds, minutes, hours or years, and,

t is operating time in seconds, minutes, hours or years.

The integration of the probability density function will produce the cumulative density function, also known as the probability to failure, F(t).^[28]

$$F(t) = 1 - e^{-\lambda t} = 1 - e^{-\frac{1}{m}t}$$

Where : λ is the equipment failure rate,

m is mean time to failure, or mean time between failure in seconds, minutes, hours or years, and,

t is operating time in seconds, minutes, hours or years.

The probability density function of exponential distribution is affected by 2 parameters, which are the failure rate (λ , lambda) and the location parameter. As shown in **figure 2.9** and **figure 2.10**.

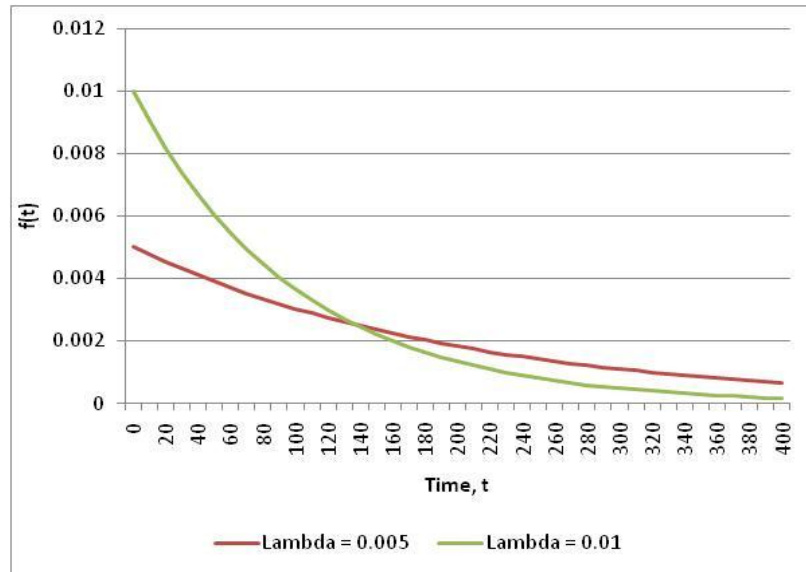

Figure 2.9 : Difference in probability density function with changing lambda(Exponential distribution)

With increasing failure rate, the probability density function will increase in its slope.

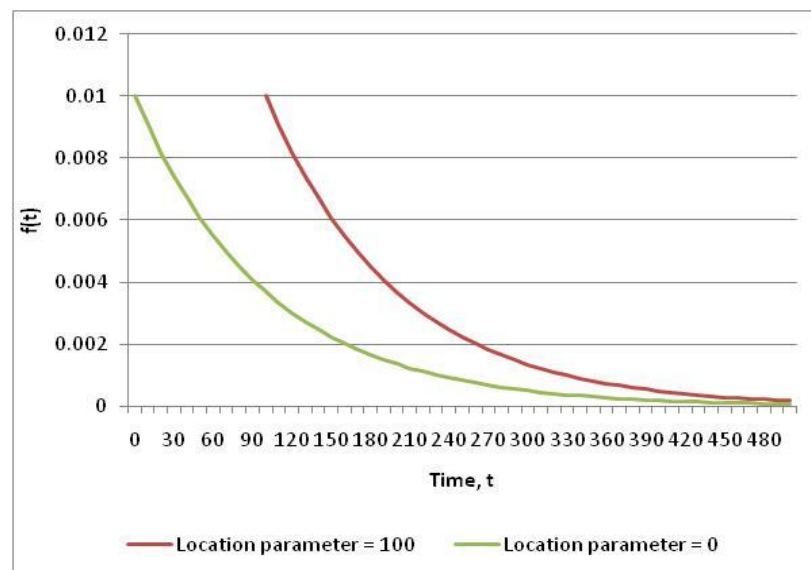

Figure 2.10 : Difference in probability density function with changing location parameter(Exponential distribution)

Changing the value of the location parameter (location parameter value > 0) will create an offset to the probability density function curve.

2.4. MICROSOFT EXCEL 2010

Microsoft Excel 2010 is the current version of a paid spreadsheet application released by Microsoft Windows in the Microsoft Office 2010 pack. Microsoft Excel is famous because of its ability in performing calculations, graphing tools, pivot table and a macro programming language called Visual Basic for Applications. It is widely used as the standard spreadsheet application worldwide and has been considered to be an ordinary skill to be mastered in engineering field.

Microsoft Excel 2010 has all the features from its predecessor Excel 2007, using grid of cells arranged in numbered rows and letter named columns that allows user to manipulate the data for any mathematical operations. Within the application itself, it has numerous supplied functions to guide the user in statistical, engineering and financial problems. Furthermore, the data inserted and calculated can be represented in graphical forms with charts, histograms, and graphs, both in two-dimensional or three-dimensional configuration.^[29]

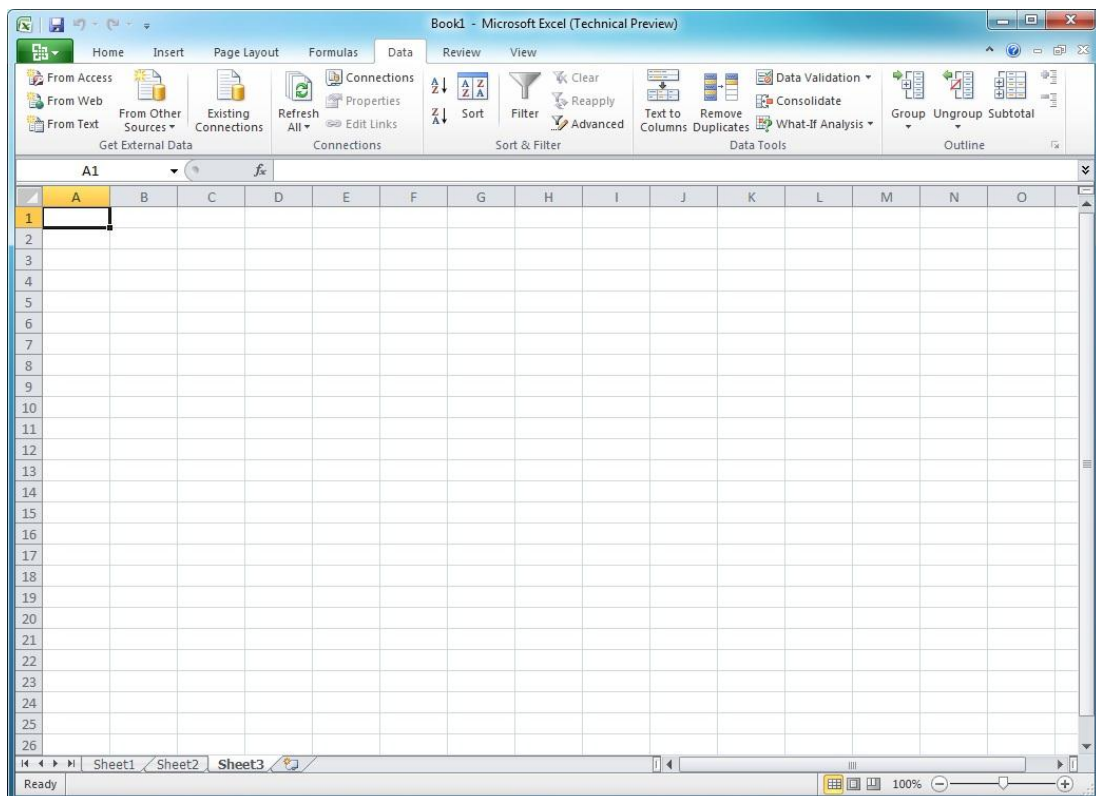

Figure 2.11 : Screenshot of Microsoft Excel 2010^[31]

In reliability engineering perspective, Microsoft Excel is proven to be a useful tool in analyzing data as it has the capability to store thousands of data in a single spreadsheet. However, the user has to come up with formulas written in line to further the analyzing steps, rather than some more expensive applications such as ReliaSoft Weibull++ or BlockSim where the formulas are already built-in and user can just click it for results. Yet, Microsoft Excel comes with versatility that is compatible in any personal computer worldwide that makes it preferable than any other applications available in the market nowadays. The data is then can be presented in graphical manner which helps the reliability engineers predict and planned further action for the reliability and maintenance planning.^[30]

2.5. RELIASOFT BLOCKSIM 8

Reliasoft BlockSim 8 is the latest version from ReliaSoft that supports an extensive array of reliability block diagram configurations and fault tree analysis gates and events, including advanced capabilities to model complex configurations, load sharing, standby redundancy, phases and duty cycles. Using exact computations and/or discrete event simulation, BlockSim facilitates a wide variety of analyses for both repairable and non-repairable systems. This includes system reliability analysis, identification of critical components, reliability optimization, system maintainability analysis, system availability analysis, throughput calculation, resource allocation for maintenance planning, and life cycle cost analysis.

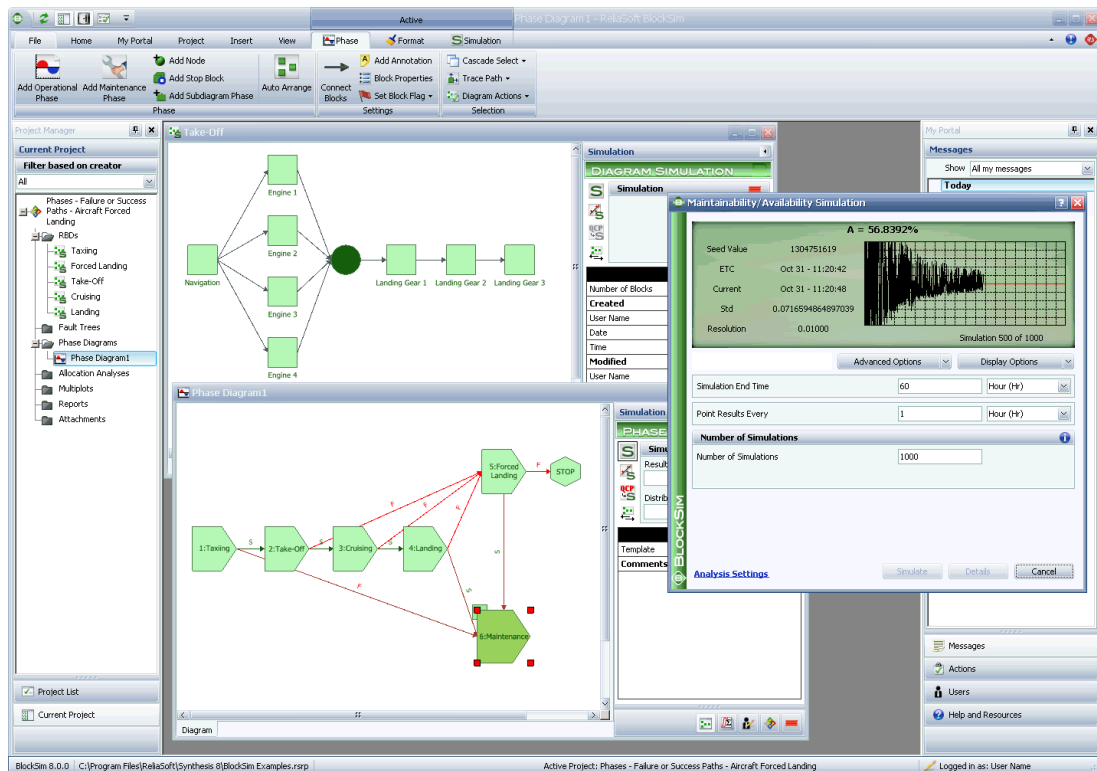

Figure 2.12 : Screenshot of Reliasoft BlockSim 8 user interface^[33]

Reliasoft BlockSim software provides an extensive array of tools to help the user model and analyze systems and/or processes, which can support the needs of both product designers and equipment operators or asset managers. ReliaSoft's BlockSim software helps the user to identify critical components or failure modes and determine the most effective ways to improve system performance through design improvements and/or maintenance planning. Furthermore, it also use

simulation to obtain estimated performance metrics that can facilitate decision-making in a variety of areas, such as scheduling planned maintenance, planning for spares, identifying bottlenecks in production throughput and estimating life cycle costs. Lastly, it can aid the user in identifying vulnerabilities in a system and determine the most effective ways to reduce the risk.^[32]

CHAPTER 3 : METHODOLOGY

This section will emphasize on the methods planned for this project. With timeframe of 28 weeks, the author has planned several works to accomplish this project.

3.1. PROJECT MILESTONES

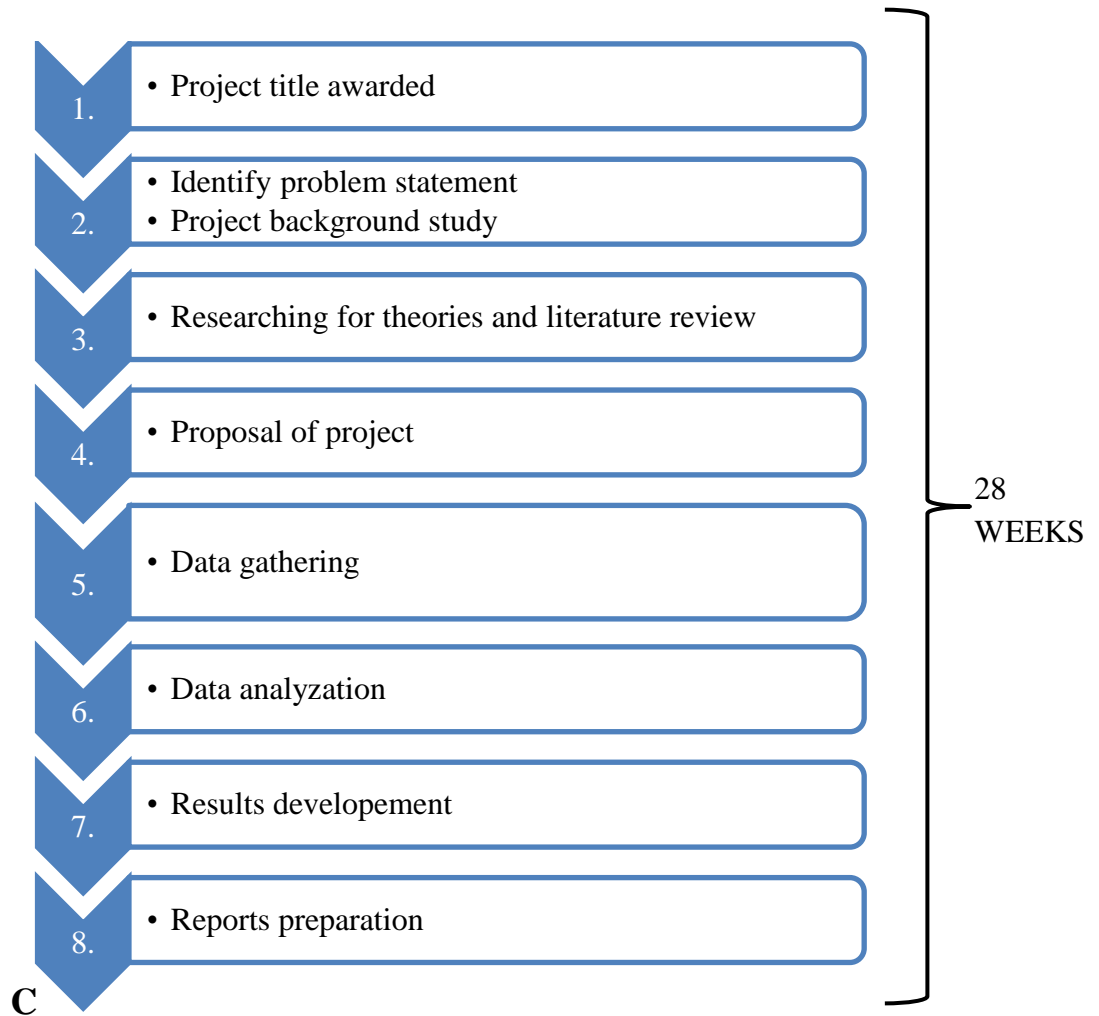

Figure 3.1 : Project milestones during the course of project

3.2. DATA GATHERING AND ANALYZATION

In collecting and presenting the data and results for the project, the author uses specific methods in ensuring the data collected is certified and validated correctly.

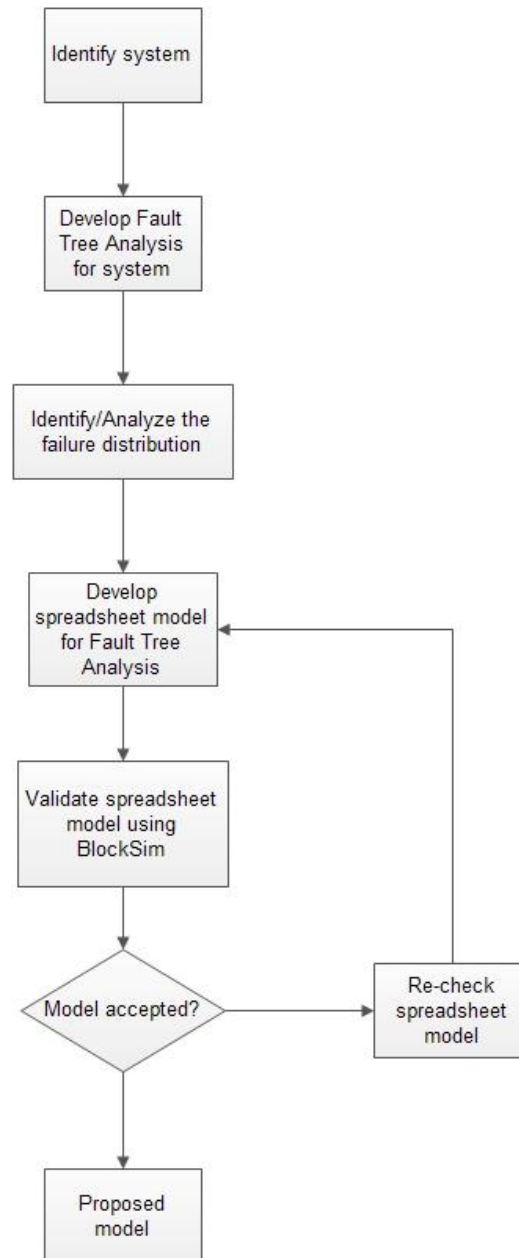

Figure 3.2 : Data gathering, analyzation and results production methodology flowchart

3.3. GANTT CHART

This section emphasizes on the works and tasks that the author undertake in fulfillment of the requirements of final year project. The Gantt chart displayed in **figure 3.3** and **figure 3.4** shows the tasks for the period of 29 weeks.

3.3.1. FINAL YEAR PROJECT I

ACTIVITIES	WEEKS													
	1	2	3	4	5	6	7	8	9	10	11	12	13	14
Project title selection	■	■												
Literature review			■	■	■	■								
Extended proposal preparation & submission				■	■	■								
Proposal defense and progress evaluation								■	■					
Draft interim report										■	■	■	■	
Final interim report review and submission														■

Figure 3.3 : Gantt Chart for final year project 1 (May 2012-September 2012)

3.3.2. FINAL YEAR PROJECT II

ACTIVITIES	WEEKS														
	1	2	3	4	5	6	7	8	9	10	11	12	13	14	15
Data gathering & analyzation	■	■	■	■	■	■	■	■	■	■					
Progress report preparation & submission								■	■						
Poster preparation										■					
Pre-Sedex presentation											■				
Dissertation (soft bound) & technical report preparation & submission												■	■		
Oral presentation														■	
Dissertation (hard bound) preparation & submission														■	■

Figure 3.4 : Gantt Chart for final year project 2 (September 2012 – December 2012)

CHAPTER 4 : RESULTS AND DISCUSSIONS

In this chapter, the author focuses on the results obtained by following the literature and methodology mentioned earlier. However, the results obtained are still up for improvement as they were created with constraints from the work scope. By widening these scopes, the result will be more accurate and can be applied in all applications in reliability engineering field.

Following the project's objectives, the final result is an analytical fault tree analysis diagram developed in Microsoft Excel. The resultant value from the spreadsheet is validated using ReliaSoft BlockSim 8. The fault tree analysis was developed from a simplified schematic diagram obtained and validated by the project's supervisor. Before the analytical fault tree analysis was acquired, it is first being created normally for qualitative analysis. From the spreadsheet, further discussions are made to justify the relevancy of the result.

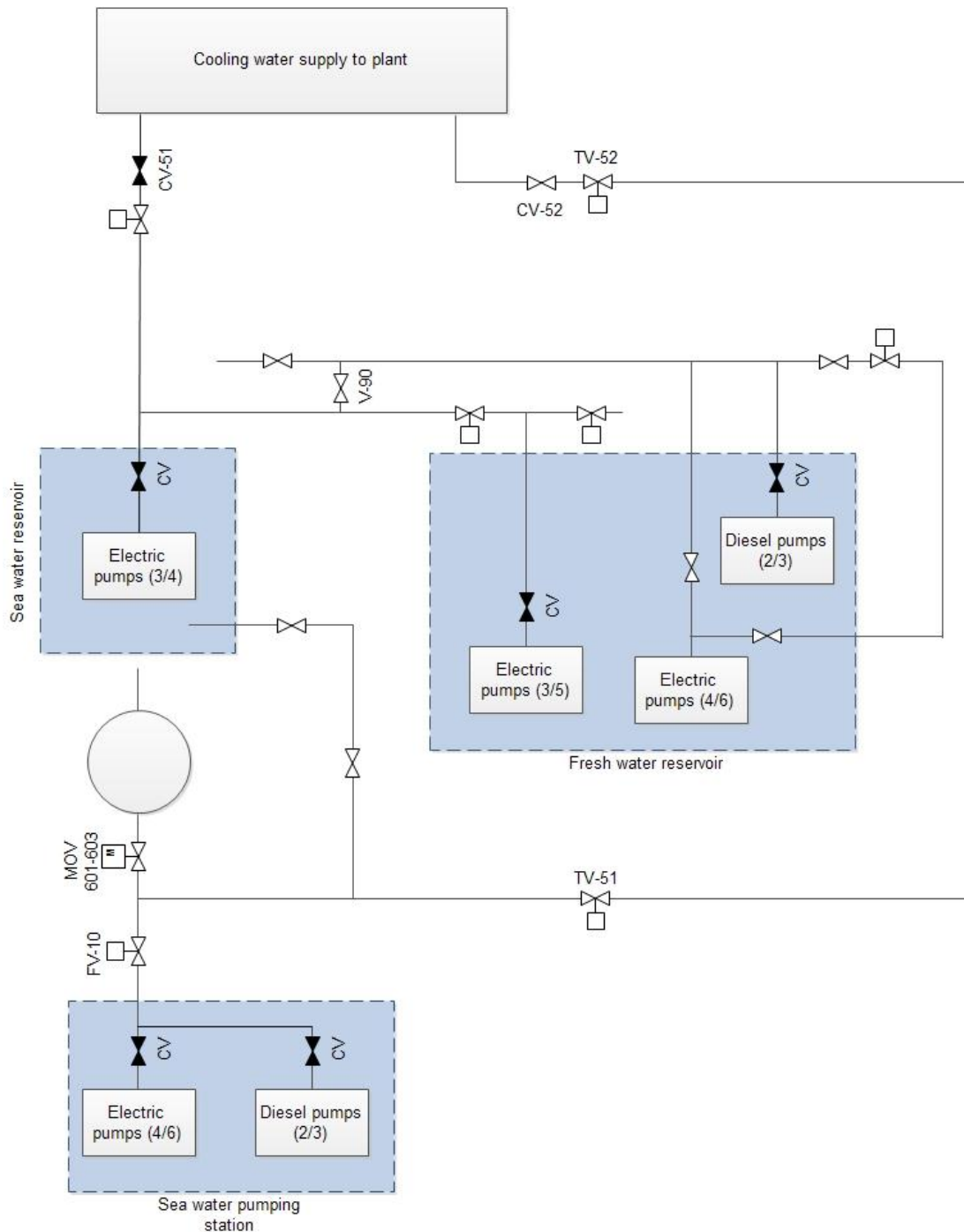

Figure 4.1 : Simplified schematic diagram of the cooling water system^[12]

The fault tree analysis of the cooling water system emphasizes the loss of cooling water due to loss of electrical power. In the schematic shown in **figure 4.1**, the dependency of the system relies on the electrical pumps that supply the power to drive the cooling water from the freshwater and seawater reservoir into the plant operation. In an event of power failure, all the electric pumps will be disabled and thus cutting off the supply from the reservoirs. To counter that, diesel pumps are

installed at the reservoirs to back up the loss of pumping ability from the electric pumps.

Therefore, the undesired event that is chosen as the top event is when the cooling water system failed to deliver due to a power outage. To make sure that during a power outage the supply of cooling water is continuous; diesel pumps are installed to overcome this matter. However, the diesel pumps are also prone to failure. These are the key points in the fault tree analysis, as it will focus on how does the system is affected by the reliability of the diesel pumps and its components.

As shown in **figure 4.9**, the basic events of the fault tree analysis are assumed experiencing failure according to a rate that follows a certain distribution. Based on the literature review and the scope of study, author assumed that it may follow 2-parameters Weibull distribution, or exponential distribution, or log-normal distribution. These three distributions were chosen as it were the most applied distribution in performing failure analysis. Author applies the equation for cumulative density function for 2-parameter Weibull distribution, lognormal distribution and exponential distribution, and equation 2.3 in developing the spreadsheet. According to the equations, the user-input value is implied to time of failure, t , of each equation. Only the cumulative density functions were used as it will produce the probability to failure values. The spreadsheet template of the fault tree analysis is shown in Figure 4.10.

However, inserting the formulas into spreadsheet requires different setup. The formulas were written in line to obey the requirements from the applications and also the constraints that the author applied. Therefore, the formula were re-written and stated as follows :

```
=IF(AH14="log-normal",LOGNORM.DIST(AH18,IF(AG15="mean
:",AH15,0),IF(AG17="standard deviation
:",AH17,0),TRUE),IF(AH14="exponential",1-(EXP(-((IF(AG15="failure rate
:",AH15,0))*(AH18))))),IF(AH14="weibull",1-(EXP(-(((AH18)/(IF(AG17="eta
:",AH17,0))))^(IF(AG15="beta :",AH15,0))))),"
```

Equation 4.1 : Function of 2-parameters Weibull distribution, Lognormal distribution, and Exponential distribution in Microsoft Excel 2010 with several constraints

The values are constricted to a specific cell in the spreadsheet and therefore cannot be applied to other spreadsheets. The values that the **equation 4.1** generates are the probability of failure that follows the chosen distribution.

	Diesel pumps (2/3) failure to start
Failure Distribution :	Weibull
Beta :	Exponential Log-normal Weibull
Eta :	1000
Time to failure, Hour :	2
Probability to failure :	0.043736101

Figure 4.2 : User chose the failure distribution that fits the basic events of failure

In choosing the failure distribution, the user must also provide input of the parameters of the distribution chosen as shown in **Figure 4.3**. For exponential distribution, the user must provide the failure rate, λ . For lognormal distribution, the user must provide the mean and standard deviation. For 2-parameters Weibull distribution, the user must provide shape parameter, β (beta) and the scale parameter, η (eta). Furthermore, the user also must insert the time to failure, in hour to satisfy the function.

Event 2	Diesel pumps (2/3) failure to start
Failure Distribution :	Weibull
Beta :	0.5
Eta :	1000
Time to failure, Hour :	1
Probability to failure :	0.031128006

Event 2	Diesel pumps (2/3) failure to start
Failure Distribution :	Exponential
Failure rate :	0.5
	1000
Time to failure, Hour :	1
Probability to failure :	0.39346934

Event 2	Diesel pumps (2/3) failure to start
Failure Distribution :	Log-normal
Mean :	0.5
Standard Deviation :	1000
Time to failure, Hour :	1
Probability to failure :	0.499800529

Figure 4.3 : User must insert certain inputs according to the chosen failure distribution

After inserting the respective value, the generated value is the probability of failure of each event. In combining all the events, the AND gate and the OR gate are applied. Equations that are applied when value move through these gates are :

For OR gate,

$$\text{Total Probability of Failure, } P_{f,t} = P_{f,a} + P_{f,b} - P_{f,a}P_{f,b}$$

Where subscript a and b denotes the events.

For AND gate,

$$\text{Total Probability of Failure, } P_{f,t} = P_{f,a}P_{f,b}$$

Where subscript a and b denotes the events.

In implementing the equations into the spreadsheet, considering the user approach, the following lines replace the equations.

$$=IF(D14="and gate",F20*B20,B20+F20-(B20*F20))$$

Equation 4.2 : Functions of logic gate (AND and OR) in Microsoft Excel 2010

Again, the function is constricted to specific cells in the spreadsheet and therefore this equation cannot be applied in another spreadsheet.

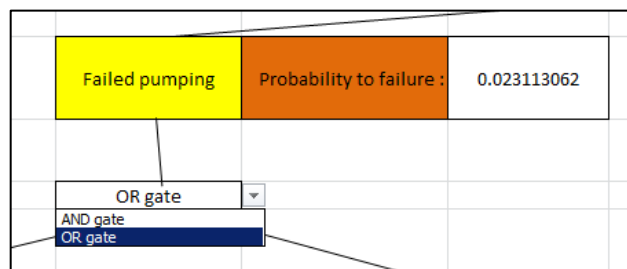

Figure 4.4 : User will choose the appropriate logic gate according to given situation

In validating the spreadsheet template with ReliaSoft BlocksIm 8, the controlled values are the failure rates for all basic events, specified to certain distributions with unit for failure rate is failure per hour. Furthermore, all the logic gates are specified to OR gate except for the top event. The data plot shape from the spreadsheet template in **figure 4.6** is compared to the data plots developed in BlockSim 8 shown in **figure 4.5(a)** and **4.5(b)**. It is observed that all data plot represents the same shape accurately and thus validating the spreadsheet template.

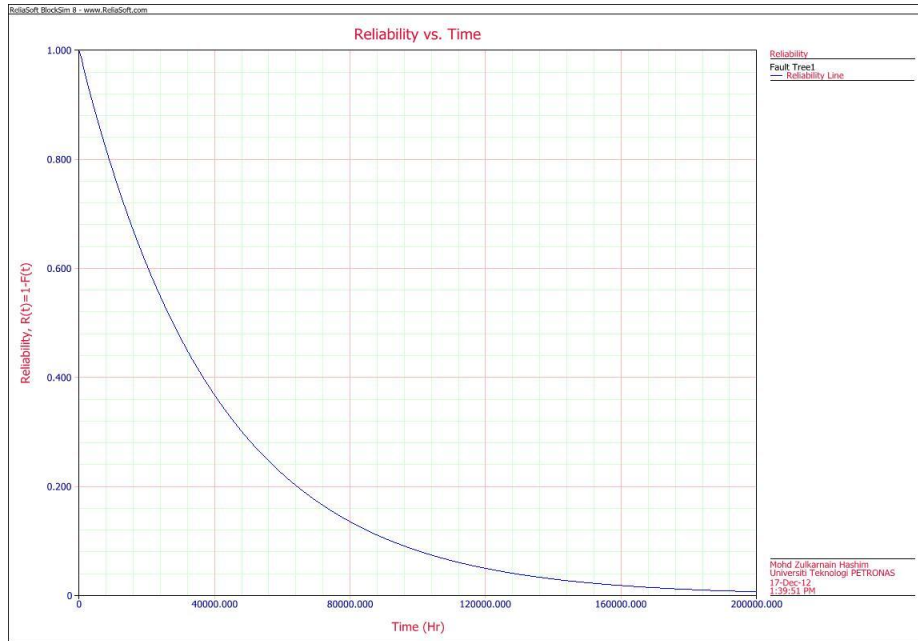

Figure 4.5(a) : Reliability versus time plot developed using BlockSim 8

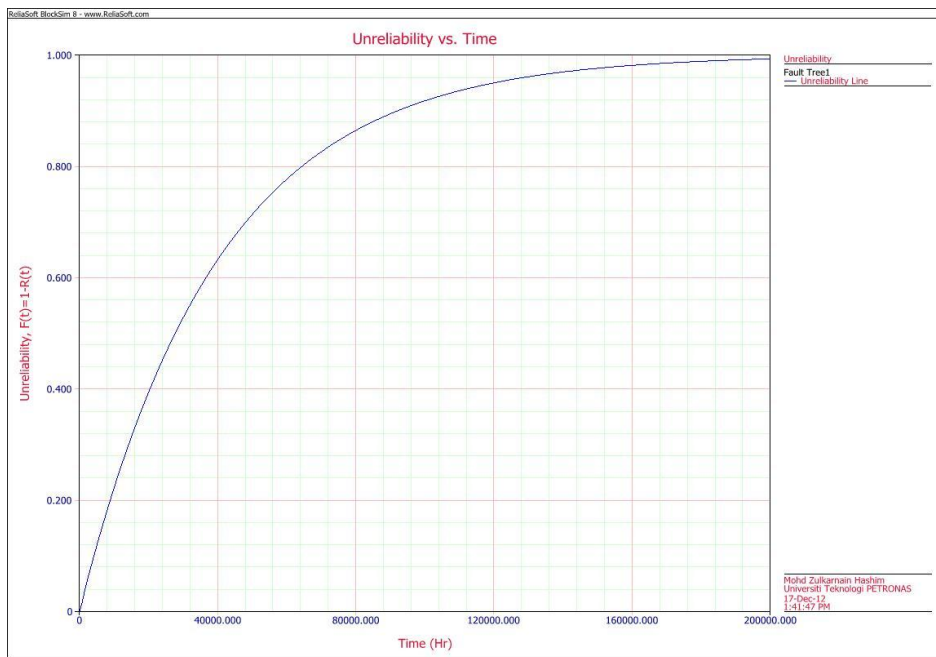

Figure 4.5(b) : Unreliability versus time plot developed using BlockSim 8

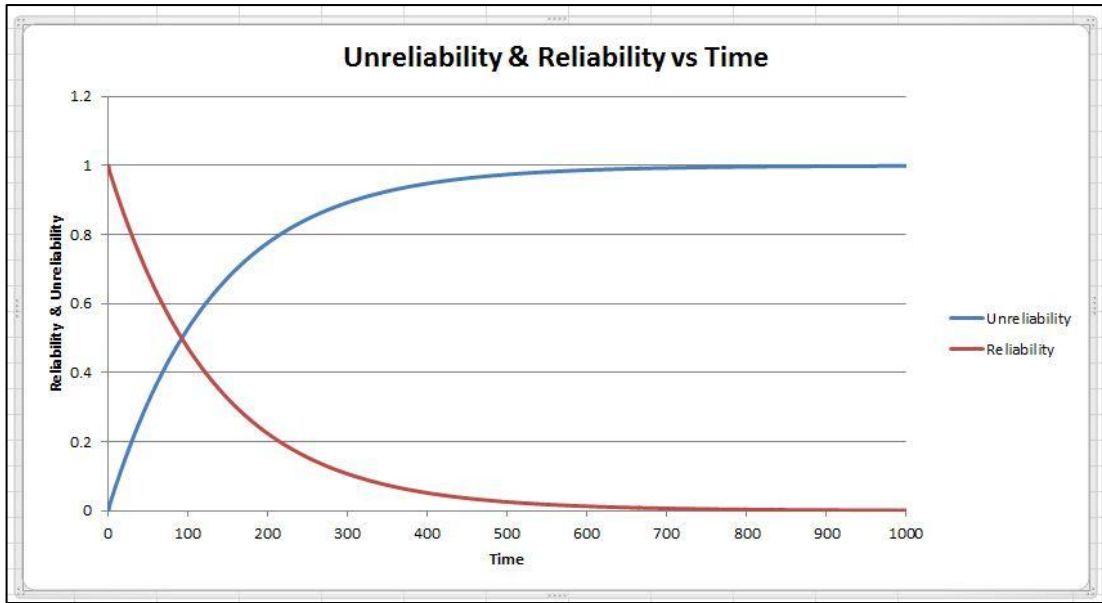

Figure 4.6 :Reliability and unreliability versus time plot developed using Microsoft Excel 2010 template

To improve the utilization of Microsoft Excel 2010, the spreadsheet will also develop the graph plotting for the system reliability and unreliability. With certain modifications, the graph plotting for each event are also available as all the data of all events are obtained until the 1000th hour as shown in **Figure 4.7** and **Figure 4.8**.

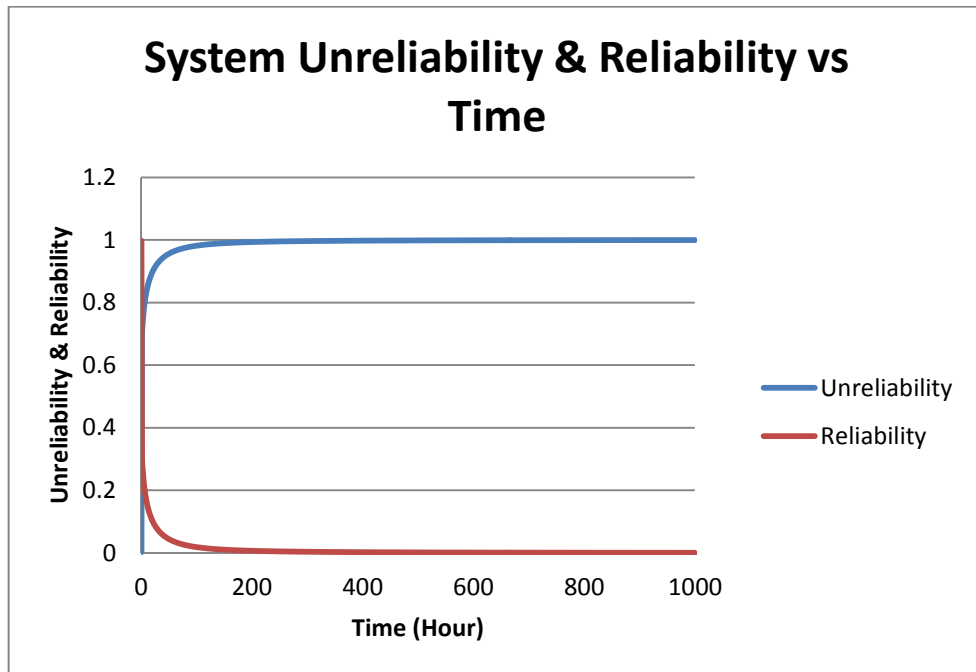

Figure 4.7 : Plotting of the whole system reliability and unreliability versus time until 1000th hour

Event 17			Event 18			Total System		
Logic Gate : OR gate			Logic Gate : OR gate			Logic Gate : AND gate		
Time-to-failure, Hour	Probability to fail	Reliability	Time-to-failure, Hour	Probability to fail	Reliability	Time-to-failure, Hour	Probability to fail	Reliability
1	0.58775727	0.41224273	1	0.118699245	0.881300755	1	0.002171687	0.997828313
2	0.619702949	0.380297051	2	0.163470985	0.836529015	2	0.695784228	0.304215772
3	0.642490825	0.357509175	3	0.19616028	0.80383972	3	0.727937074	0.272062926
4	0.660623057	0.339376943	4	0.222625721	0.777374279	4	0.752346024	0.247653976
5	0.675826473	0.324173527	5	0.245132436	0.754867564	5	0.771997791	0.228002209
6	0.688979535	0.311020465	6	0.264840084	0.735159916	6	0.788392781	0.211607219
7	0.700600246	0.299399754	7	0.282436367	0.717563633	7	0.802404897	0.197595103
8	0.711023763	0.288976237	8	0.298368593	0.701631407	8	0.814592767	0.185407233
9	0.720481331	0.279518669	9	0.312946933	0.687053067	9	0.825337243	0.174662757
10	0.729140219	0.270859781	10	0.326396835	0.673603165	10	0.834910599	0.165089401
11	0.737125901	0.262874099	11	0.338888206	0.661111794	11	0.843514712	0.156485288
12	0.744535247	0.255464753	12	0.350552819	0.649447181	12	0.851303671	0.148696329
13	0.751444482	0.248555518	13	0.361495291	0.638504709	13	0.858397887	0.141602113
14	0.75791632	0.24208368	14	0.371800298	0.628199702	14	0.86489332	0.13510668
15	0.764000291	0.235999709	15	0.381537507	0.618462493	15	0.870867714	0.129132286
16	0.769738724	0.230261276	16	0.390765042	0.609234958	16	0.876384955	0.123615045

Figure 4.8 : Screenshot of the data of each event showing the probability to fail and reliability until the 1000th hour

With these data and graphs, the user can identify and predict the critical events, identify the most suitable time for maintenance works, and approximate the time to failure for each event with respect to a specific distribution. The versatility of

Microsoft Excel is that the data inside the spreadsheet can always be altered to suit the user's preference.

Focusing back towards the cooling water system case study, the reliability and unreliability of the system and each event totally depend on the correct failure distribution chosen. In order to achieve that, further inspection works and previous failure analysis study need to be taken into consideration. Although the spreadsheet produces ample and almost accurate data with validation from an established reliability analysis software, the correct assumption from the user is needed in order to yield a far more accurate and applicable results.

CHAPTER 5 : CONCLUSION

Following the scope of study and with guide from the aim and objectives, the project can be concluded. The fault tree analysis spreadsheet template has been proven to be accurate with validation from established reliability analysis software, ReliaSoft BlockSim 8. Even though the data generated from the spreadsheet is 99.9987% accurate; several modifications can be done to improve the accuracy of data and also the adaptable aspect of the template. For now, the template is proven to serve most of the features that are available in expensive reliability analysis software, with further modification and recommendation, the template can be used in any aspect of reliability engineering in the fault tree analysis scope.

Regarding the case study; the cooling water system failure due to power outage, study shown that the failure can be predicted and measure by the fault tree analysis tool developed. To improve on the accuracy and the relevancy of the results obtained, proper assumptions and further expert opinions on the matter are required. The results obtained from this study can serve as a baseline as it covers most of the important failure distributions that are currently implemented by the reliability engineers in the field work.

Therefore, the project can be considered as successful as all the objectives are achieved and further improvements are needed to increase the value of this study.

CHAPTER 6 : REFERENCES

1. Water - Wikipedia, the free encyclopedia
<http://en.wikipedia.org/wiki/Water>
2. Gleick, P.H., ed. (1993). Water in Crisis: A Guide to the World's Freshwater Resources. Oxford University Press. p. 13, Table 2.1 "Water reserves on the earth".
3. "Maintenance Terminology - Some Key Terms", The Reliability Revolution, Sandy Dunn, Webmaster, Plant Maintenance Resource Center
<http://www.maintenanceresources.com/referencelibrary/maintenancemanagement/keyterms.htm>
4. Failure Analysis – Wikipedia, the Free Encyclopedia
http://en.wikipedia.org/wiki/Failure_analysis
5. P. L. Clemens (1993). Fault Tree Analysis, 4th Edition
6. Zio, Enrico (2007). Introduction to the Basics of Reliability and Risk Analysis.. World Scientific. (Chapter 7)
7. Ramachandran, V.; Raghuram, A.C.; Krishnan, R.V.; Bhaumik, S.K. (2005). Failure Analysis of Engineering Structures - Methodology and Case Histories.. ASM International. (Chapter 5, Sub-topic 5.6 : Fault Tree Analysis)
8. Berk, Joseph (2009). Systems Failure Analysis. ASM International. (Chapter 5)
9. Failure Analysis – Wikipedia, the Free Encyclopedia
http://en.wikipedia.org/wiki/Fault_tree_analysis#Graphic_Symbols
10. Water cooling - Wikipedia, the free encyclopedia
http://en.wikipedia.org/wiki/Water_cooling
11. King, James J. The Environmental Dictionary (3rd Edition) John Wiley & Sons (1995)
12. Training - Fault Tree – S2S – A Gateway for Plant and Process Safety
http://www.safety-s2s.eu/modules.php?name=s2s_wp4&op=v&idp=1476
13. What's the role of the reliability engineer?
<http://www.reliableplant.com/Read/23083/role-reliability-engineer-operations>

14. Society of Reliability Engineers
<http://www.sre.org/>
15. Ebeling, Charles E., (1997), An Introduction to Reliability and Maintainability Engineering, McGraw-Hill Companies, Inc., Boston.
16. Leemis, Lawrence, (1995) Reliability: Probabilistic Models and Statistical Methods, 1995, Prentice-Hall.
17. Weibull Distribution -- from Wolfram MathWorld
<http://mathworld.wolfram.com/WeibullDistribution.html>
18. Wayne Nelson (2004) Applied Life Data Analysis. Wiley-Blackwell.
19. Weibull plot
<http://www.itl.nist.gov/div898/handbook/eda/section3/weibplot.htm>
20. Johnson, Norman L.; Kotz, Samuel; Balakrishnan, N. (1994), Continuous univariate distributions. Vol. 1, Wiley Series in Probability and Mathematical Statistics: Applied Probability and Statistics (2nd ed.), New York: John Wiley & Sons.
21. Engineering statistics handbook. National Institute of Standards and Technology. 2008.
22. Exponential distribution - Wikipedia, the free encyclopedia
http://en.wikipedia.org/wiki/Exponential_distribution
23. Exponential Distribution -- from Wolfram MathWorld
<http://mathworld.wolfram.com/ExponentialDistribution.html>
24. Hazewinkel, Michiel, ed. (2001), "Exponential distribution", Encyclopedia of Mathematics, Springer.
25. Log-normal distribution - Wikipedia, the free encyclopedia
http://en.wikipedia.org/wiki/Log-normal_distribution
26. Log Normal Distribution -- from Wolfram MathWorld
<http://mathworld.wolfram.com/LogNormalDistribution.html>
27. Aitchison, J. and Brown, J.A.C. (1957) The Lognormal Distribution, Cambridge University Press.
28. Session 2 – Reliability Mathematics.ppt, 2012, MBB 4123, Reliability and Maintenance, Mechanical Engineering Department, Universiti Teknologi PETRONAS.
29. Microsoft Excel - spreadsheet - office.com
<http://office.microsoft.com/en-us/excel/>

30. Microsoft Excel - wikipedia, the free encyclopedia
http://en.wikipedia.org/wiki/Microsoft_Excel
31. Image source :
http://static.wix.com/media/10ea99_8f8a059602b86e4994c4ccd2d17065a1.jpg
32. reliasoft blocksim - wilde analysis
<http://wildeanalysis.co.uk/reliability/software/reliasoft/blocksim>
33. image source :
http://wildeanalysis.co.uk/system/photos/2142/original/blocksim_mdi.gif?1343822173