

**THE EFFECT OF POLYVINYL ALCOHOL (PVA) FIBER  
TO THE TENSILE STRENGTH OF CONCRETE**

by

**MUHAMAD SAFRIZAL BIN ABDULLAH**

FINAL YEAR PROJECT REPORT  
Submitted to the Civil Engineering Programme  
in partial fulfillment of the requirements  
for the Degree  
Bachelor of Engineering (Hons)  
(Civil Engineering)

JULY 2008

Universiti Teknologi PETRONAS  
Bandar Seri Iskandar  
31750 Tronoh  
Perak Darul Ridzuan

## TABLE OF CONTENTS

<b>CERTIFICATION OF APPROVAL</b> .....	vii
<b>CERTIFICATION OF ORIGINALITY</b> .....	viii
<b>ABSTRACT</b> .....	ix
<b>ACKNOWLEDGEMENT</b> .....	x
<b>1. INTRODUCTION</b>	
1.1. Problem Statement .....	1
1.2. Objectives and Scope of Study .....	2
<b>2. LITERATURE REVIEW</b>	
2.1. Introduction of PVA fiber.....	3
2.2. Properties of PVA fiber	
2.2.1. Average diameter of fiber.....	7
2.2.2. Fiber aspect ratio.....	7
2.2.3. Volumetric concentration of fiber.....	7
2.2.4. Dispersion of fiber.....	8
2.2.5. The angle of fiber.....	8
2.3. Theories of PVA fiber behaviour.....	9
2.4. Comparison of PVA, PP and carbon fibers.....	10
2.5. Splitting Tensile Strength.....	11
2.6. Concrete Mixing.....	11
<b>3. METHODOLOGY</b>	
3.1. Planning and details.....	13
3.2. Mix Design (British Standard).....	14
3.3. Flow Chart of Methodology.....	16
3.4. Sieving	
3.4.1. Coarse Aggregate.....	17
3.4.2. Fine Aggregate.....	17
3.5. Preparing SSD.....	17
3.6. Concrete mixing	
3.6.1. Dry mixing.....	18
3.6.2. Wet mixing.....	19
3.6.3. Improved wet mixing.....	20
3.7. Slump Test.....	21

3.8. Casting & curing.....	22
3.9. Tensile Test (Splitting Tensile Test).....	23
3.10. Key Milestone	
3.10.1. Milestone for Final Year Project 1.....	24
3.10.2. Milestone for Final Year Project 2.....	25
<b>4. HSE REQUIREMENTS</b>	
4.1. Introduction .....	26
4.2. Safety Equipments Provided in Concrete Laboratory.....	27
4.3. HSE Analysis.....	28
<b>5. RESULT AND DISCUSSION</b>	
5.1. Slump Test .....	29
5.2. Tensile Strength Test Result.....	30
5.3. Scanning Electron Microscope (SEM).....	35
5.3.1. Bonding between PVA fiber and cement.....	35
5.3.2. Changes of PVA fiber surface in concrete with time.....	36
5.4. Mixing Process.....	39
5.5. Vibrating.....	40
5.6. Slump Test .....	42
5.7. Tensile Strength Testing.....	43
<b>6. CONCLUSION.....</b>	<b>45</b>
<b>7. RECOMMENDATIONS.....</b>	<b>46</b>
<b>8. REFERENCES.....</b>	<b>47</b>
<b>9. APPENDICES</b>	
APPENDIX A : Tables and graphs for concrete mix design.....	49
APPENDIX B : Scanning Electron Microscope (SEM).....	52
APPENDIX C : Line of failure for cylindrical tensile test (example).....	56
APPENDIX D : Cross section of sample (example)	
A) Sample using hand vibrator.....	57
B) Sample using vibrating table.....	58
APPENDIX E : Superplasticizer.....	59

## LIST OF TABLES

<b>Table 3.1:</b> No of samples for each test .....	13
<b>Table 3.2:</b> Properties of PVA fiber (RF 4000) .....	14
<b>Table 4.1:</b> The Health Safety and Environment in the concrete laboratory .....	28
<b>Table 5.1 :</b> Results of slump test of fresh concrete without superplasticizer .....	29
<b>Table 5.2 :</b> Results of slump test of fresh concrete with superplasticizer .....	29
<b>Table 5.3 :</b> Max tensile load capacity and tensile strength for 0% fiber content .....	30
<b>Table 5.4 :</b> Max tensile load capacity and tensile strength for 0.5% fiber content...	30
<b>Table 5.5 :</b> Max tensile load capacity and tensile strength for 1.0% fiber content...	31
<b>Table 5.6 :</b> Max tensile load capacity and tensile strength for 1.5% fiber content...	31
<b>Table 5.7 :</b> Max tensile load capacity and tensile strength for 2.0% fiber content...	32
<b>Table 5.8 :</b> The summarized result of tensile strength test .....	32

## LIST OF FIGURES

<b>Figure 1.1</b> : Steel reinforcement in beam .....	1
<b>Figure 2.1</b> : PVA Fiber .....	2
<b>Figure 2.2</b> : PVA fiber before it is mixed into the matrix (600X mag.) .....	5
<b>Figure 2.3</b> : PVA fiber extending out from a fracture surface (600X mag.) .....	5
<b>Figure 2.4</b> : Schematic load-deflection relationship of fiber reinforced concrete ...	10
<b>Figure 3.1</b> : Flow chart of the main procedure of project .....	16
<b>Figure 3.2</b> : Sieving pans .....	17
<b>Figure 3.3</b> : Fine aggregate .....	17
<b>Figure 3.4</b> : SSD aggregate .....	17
<b>Figure 3.5</b> : Flow chart of wet mixing procedure .....	18
<b>Figure 3.6</b> : Flow chart of wet mixing procedure .....	19
<b>Figure 3.7</b> : Flow chart of improved wet mixing procedure .....	20
<b>Figure 3.8</b> : Slump test illustrations .....	21
<b>Figure 3.9</b> : Cylinder moulds (200x100) .....	22
<b>Figure 3.10</b> : Specimen holder for tensile strength test of cylinder .....	23
<b>Figure 3.11</b> : The arrangement for tensile strength test of cylindrical sample .....	23
<b>Figure 4.1</b> : Safety Equipments Provided in Concrete Laboratory .....	27
<b>Figure 5.1</b> : Tensile strength development of PVA reinforced concrete .....	33
<b>Figure 5.2</b> : The effect of PVA fiber to the tensile strength of the concrete .....	34
<b>Figure 5.3</b> : The bond between the PVA fiber and cement .....	36
<b>Figure 5.4</b> : Original PVA fiber surface (100X magnification) .....	36
<b>Figure 5.5</b> : PVA fiber surface after 30 days in concrete (100X magnification) ...	37
<b>Figure 5.6</b> : PVA fiber surface after 60 days in concrete (100X magnification) ...	37
<b>Figure 5.7</b> : PVA fiber surface after 90 days in concrete (70X magnification) .....	38
<b>Figure 5.8</b> : Drum type concrete mixer .....	39
<b>Figure 5.9</b> : Vibrator .....	40
<b>Figure 5.10</b> : The coarse aggregate is concentrated at the outer side of sample .....	41

<b>Figure 5.11 : Vibrating Table .....</b>	<b>41</b>
<b>Figure 5.12 : The cross section of the sample using vibrating table .....</b>	<b>42</b>
<b>Figure 5.13 : Slump of concrete with 0% fiber .....</b>	<b>42</b>
<b>Figure 5.14 : Slump of concrete with 2% fiber .....</b>	<b>43</b>
<b>Figure 5.15 : Cylindrical sample holder for tensile test .....</b>	<b>43</b>
<b>Figure 5.16 : Line of failure of tensile test .....</b>	<b>44</b>

# CERTIFICATION OF APPROVAL

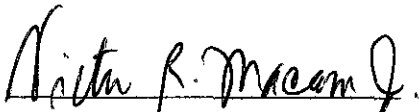
## THE EFFECT OF POLYVINYL ALCOHOL (PVA) FIBER TO THE TENSILE STRENGTH OF CONCRETE

by

Muhamad Safrizal bin Abdullah

A project dissertation submitted to the  
Civil Engineering Programme  
Universiti Teknologi PETRONAS  
in partial fulfillment of the requirement for the  
Bachelor of Engineering (Hons)  
(Civil Engineering)

Approved by:

  
( Victor R. Macam, Jr., PhD )

Project Supervisor

UNIVERSITI TEKNOLOGI PETRONAS  
TRONOH, PERAK

December 2008

## **CERTIFICATION OF ORIGINALITY**

This is to certify that I am responsible for the work submitted in this project, that the original work is my own except as specified in the references and acknowledgements, and that the original work contained herein have not been undertaken or done by unspecified sources or persons.



---

(MUHAMAD SAFRIZAL ABDULLAH)



## ABSTRACT

This study is focusing on the tensile strength of PVA (polyvinyl alcohol) fiber-reinforced concrete. By designing mix compositions, a high performance composite can be produced with a small amount of short fibers. Concrete is a material which has high compressive strength, but the tensile strength is only about 10 per cent of the compressive strength. The project includes the study of PVA fiber by doing research through journals and books and laboratory experimental works. For each percentage of PVA fiber (0%, 0.5%, 1.0%, 1.5% and 2.0%), 12 cylindrical specimens with dimension of 200 x 100 are made for split tensile test. The specimens are fairly distributed for tests at 3<sup>rd</sup> day, 7<sup>th</sup> day, 28<sup>th</sup> day and 60<sup>th</sup> day. The specimens were subjected to wet curing for hydration process. The polyvinyl alcohol fibers form a strong bond with cementitious matrix due to their hydrophilic nature and geometric characteristics. The experimental results show that formulations containing PVA fibers presented higher tensile strength. The optimum PVA content in achieving the highest tensile strength of the concrete is found to be 1% of the cement content. The addition of 1% PVA fiber results to the tensile strength enhancement of 27% at 28<sup>th</sup> day. The workability of the concrete mix decreases with higher PVA fiber content based on research done.

## **ACKNOWLEDGEMENT**

The author would like to express the gratitude to Dr Victor R. Macam, Jr., (Final year project supervisor) who mostly guided and supervised on the accomplishment of this final year project titled “The effect of polyvinyl alcohol (PVA) fiber to the tensile strength of concrete”.

The author also would like to thank the technicians of concrete laboratory and mechanical laboratory for their cooperation in finishing this project.

Regretting to miss, a highly appreciation to the management of Universiti Teknologi Petronas for providing the test equipments in the laboratories and also the allowance in buying the raw materials that used in the project.

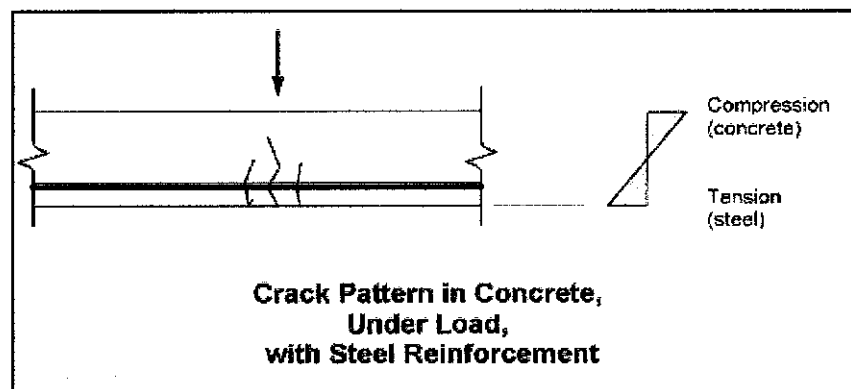


## CHAPTER 1

### INTRODUCTION

#### 1.1 Problem Statement

Reinforced concrete is generally a strong material that used in many structure constructions. It is a highly durable and can be formed into various shapes and size ranging from a simple rectangular column, to a slender curved dome or shell. The tensile strength of concrete is approximately 10 per cent of the compressive strength. In application, the concrete is reinforced together with steel in order to govern the tensile force as shown in **Figure 1.1**. All designs of concrete elements, the tensile strength of concrete is not taken into consideration and commonly taken as zero for the safety factor.



**Figure 1.1:** Steel reinforcement in beam

Generally, microcracks start to generate in the concrete at about 10-15 percent of the ultimate load and it propagates into macrocracks at about 25-30 percent of the ultimate load. As the consequence, concrete structural element cannot be expected to sustain large transverse loading without the addition of reinforcement bar in the tensile zone of



supported member such as beams or slabs. However, by using the steel reinforcement bar alone cannot arrest or slow down the development of microcracks and macrocracks.

## **1.2 Objectives and Scope of Study**

The main objectives of this project are as follow:

- To study the characteristic of PVA fiber.
- To determine the behaviour of concrete with PVA content through experiment.
- To study the properties of PVA fiber-reinforced concrete in freshly mixed state and hardened state.

The scope of study for this project includes the following:

- Conducting research through journals and books published which are closely related to PVA fiber in concrete.
- Laboratory experimental assessment towards the properties of concrete infused with PVA fiber. Generally, the tests include split tensile test and compression test with static loads.



## CHAPTER 2

### LITERATURE REVIEW

#### 2.1 Introduction of PVA fiber

Concrete technology is subject to an increasing degree in specialization. One of the specializations is the incorporation of fibers into concrete design. The concept of reinforcing brittle building materials with various forms of fiber has been known since a long time ago. Mud huts made using baked clay reinforced with straw and masonry mortar reinforced with animal hair are early example of fiber-reinforced materials in construction.

Nowadays, fiber reinforced concrete has been widely used such as airport runways, slabs on grade, shotcrete for slope and tunnel stabilisation, pre-cast concrete products, coastal structures, machine foundations, defence shelter, etc. Banthia N et al. had reported that 150,000 metric tonnes is used worldwide annually [14]. The common fiber used is steel fibers.

Fibers are used to enhance the properties of the weak, brittle and crack-prone cementitious matrix. The enhancement may include in improving the tensile or flexural strength, ductility, toughness, resistance to cracking, permeability, and durability. The amount of fibers present is a major factor influencing the extent and degree of property enhancement.

The steel reinforcement bar (continuous reinforcing element) cannot stop the development of the microcracks. Fibers, on the other hand, are discontinuous and randomly distributed in the matrix both in the tensile and compressive zones of concrete structural element. The use of fibers will increase the stiffness and enhance the crack



control performance through preventing the microcracks from propagating and widening.

Composite properties are affected by fibers in both freshly mixed and hardened states. Increasing the fiber content naturally tends to improve the degree of enhancement of many properties in the hardened state, but at the same time, the mixture fluidity which is commonly known as mixture workability decreases in the freshly mixed state. According to Josef P. Kaufmann (2005), much stiffer mix is formed because the skeleton blocking of the fiber constraints the free flow of the mix [8]. Y. Mohammadi et al. had reported that the workability of the fiber reinforced concrete mix decreased uniformly with the increase in fiber content [12].

Polyvinyl alcohol (PVA) fiber (as shown in **Figure 2.1**) is an organic material which is made from carbon, hydrogen and oxygen. Degrades only approximately 1 percent over 20 years makes this material potentially increases the durability of the concrete structural elements. PVA is highly resistant to UV radiation and abrasion. This material has a high tensile strength and generally suitable to enhance the tensile strength of concrete in the hardened state.



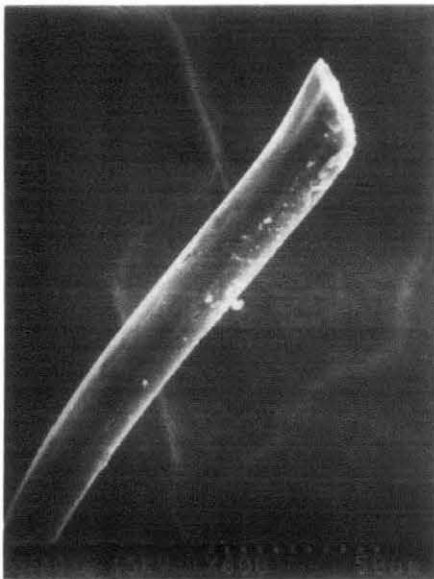
**Figure 2.1** : PVA Fiber



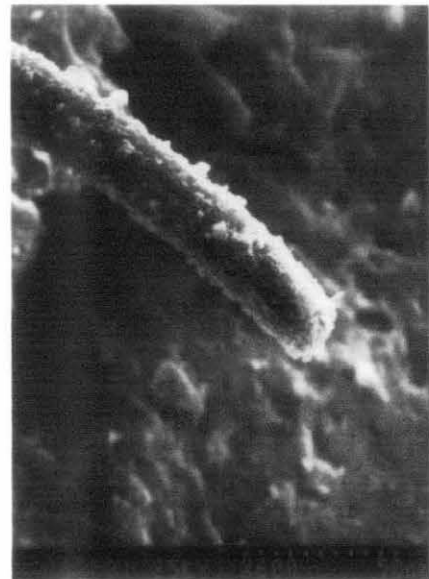
In term of shrinkage control, other fibers such as polypropylene, nylon and other synthetic fibers only restrain plastic shrinkage for the first 24 hours after the concrete poured. Due to the high elongation (stretchiness), these fibers are useless for drying shrinkage control and other sorts of cracking that all concrete suffers from. PVA fiber is a structural fiber which is less stretchy (fibers are known as structural fibers if the Young's Modulus of Elasticity of the fibers are greater than 25 GPa).

PVA fiber develops molecular and chemical bonding with cement during hydration and curing. This bond is due to the hydroxyl groups on the carbon backbone that leads to a hydrogen intermolecular bond and the strong hydrophilic characteristics of PVA fiber is the result (Akers et al. 1989).

L.R. Betterman et al. (1994) observed the bond between the PVA fiber and matrix by using electron microscope scanner (Hitachi S-570LB) [18]. They managed to scan the failure mechanism the fibers had undergone during direct tension testing. Comparison has been made between the fiber extensions from a fracture surface and the unused PVA fiber (see **Figure 2.2** and **Figure 2.3**).



**Figure 2.2:** PVA fiber before it is mixed into the matrix (600X magnification)



**Figure 2.3:** PVA fiber extending out from a fracture surface (600X magnification)



This fiber is used about  $0.9 \text{ kg/m}^3$  for crack control and may be used up to 1.4 percent for steel reinforcement reduction (Kuraray America Inc.). PVA can be used together with steel reinforcement. The concrete will be more durable if the concrete permeability is reduced. The PVA's micro-crack control helps to prevent water from reaching steel reinforcement by reducing the permeability of the concrete. The usage of PVA fiber will improve the toughness and stiffness of concrete structural elements.

Generally, PVA fiber is effective in controlling:

- Plastic shrinkage cracking
- Drying shrinkage cracking
- Autogenous cracking
- Fatigue cracking
- Spalling

## **2.2 Properties of PVA fiber**

There are several properties of PVA fiber that affect the properties of concrete as follow:

- Average diameter of fiber
- Fiber aspect ratio
- Volumetric concentration of fiber
- Dispersion of fiber
- The angle of fiber





### **2.2.1 Average diameter of fiber**

Small average diameter fibers will correspond to low flexural stiffness. However, the small size makes the fibers able to conform the shape of the space between the aggregates particles. Eduardo et al. (2004) says that smaller diameter of fiber is the main factor that gives shrinkage and cracking resistance to the concrete [1]. Higher average diameter will give higher flexural stiffness and it leads to greater effect on consolidation of aggregates in mixing and placement process.

### **2.2.2 Fiber aspect ratio**

Aspect ratio of fibers affects the difficulty in dispersion. Fiber aspect ratio can be classified as a measure of the slenderness of the fibers. Higher aspect ratio will make the fibers difficult to disperse and tends to produce non-permeable pore spaces in the composite. Thanasak and Antoine (2005) had reported that this property greatly influence the mechanical properties of the hardened concrete composite but less influence the plastic shrinkage cracking [6]. Conclusion has been made by Chen and Carson (1971) that higher compressive strength is achieved by using shorter fibers [15]. Mohammadi Y et al. (2006) had reported that short fibers are more effective in controlling micro-cracks whereas, the longer fibers are effective in controlling macro-cracks in concrete [12]. Longer fibers have better bond to the matrix due to its length and give more resistance to the pull out of fibers out of the matrix.

### **2.2.3 Volumetric concentration of fiber**

Concentration of PVA fiber in concrete significantly influences the properties of the concrete. At 0.2% fibers by volume, the plastic shrinkage cracking is reduced up to 90%. According to Thanasak and Antoine (2005), the plastic shrinkage cracking is vanished if the concrete is added with 0.4% fibers by volume [6]. Bezerra et al. (2006) reported that concrete with fiber higher than 2% by mass (from 4% to 5% by volume of the composite), synthetic fiber was unable to improve further the mechanical performance at the age of 28 days [3]. Mohammadi Y et al. (2006) concluded that best performance of hardened concrete is achieved at a fiber volume fraction of 2% [12].



### 2.2.4 Dispersion of fiber

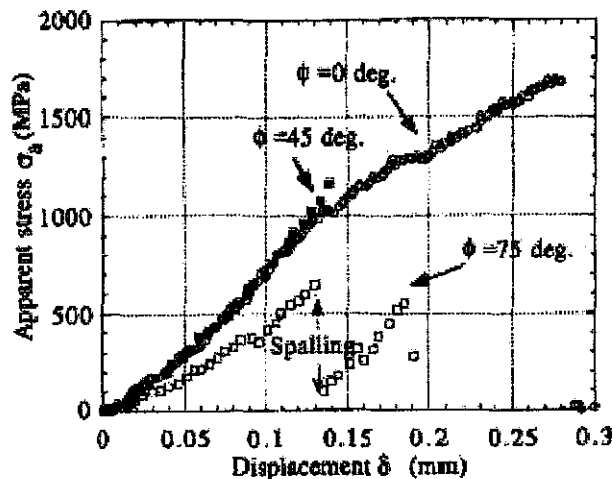
Shin-ichi et al. (2003) said that in term of fiber dispersion, more ductile composite is achieved if the fiber dispersion is uniform [9]. In order to have a clear view of fiber distribution inside concrete, fluorescence microscope and image processing are used. X-ray method cannot be used since it shows very low contrast between fibers and concrete. Inhomogeneous distribution of fibers leads to variation in ultimate tensile strain of the composite. Shin-ichi et al. (2003) had proved that distribution coefficient has a linear correlation with the ultimate tensile strength [9]. In addition, smaller fibers give more uniform dispersion compared to larger fibers as reported by Y. Mohammadi et al. (2006) [12].

### 2.2.5 The angle of fiber

According to Tetsushi and Victor (1998), the angle of fibers also affects the tensile strength of the composite. An investigation has been made and it shows that the tensile strength of the composite is reduced significantly when the fiber is inclined to  $75^\circ$  [10].

The effect is obvious and spalling is the evidence as shown in the following graph :

**Graph Apparent Stress versus Displacement**





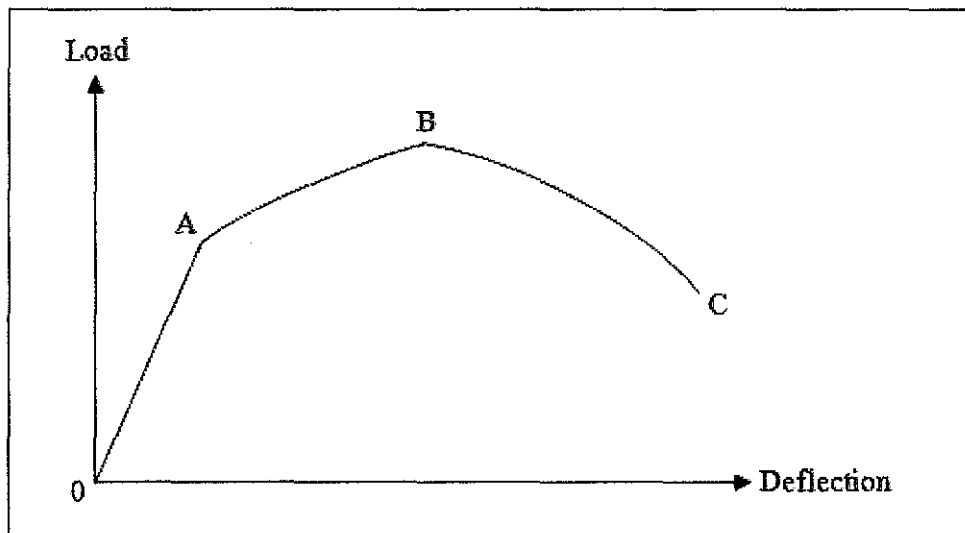
### 2.3 Theories of PVA fiber behaviour

Plastic shrinkage is a common problem encountered in concrete structure with large surface area. The rapid changes of temperature and humidity lead to the significant water evaporation and may result to the existence of tensile stresses in concrete structure. Cracking will take place when the tensile stresses exceed the tensile strength. The cracks allow the penetration of carbon dioxide, oxygen, and any other aggressive external substances that will contribute to the concrete deterioration.

Pseudostrain hardening or also can be identified as multiple cracking is a usual phenomenon in fiber reinforced concrete. The theory is related to the bridging effect of the fiber itself. During the formation of the first macro crack, the load resist by the matrix at the beginning is transferred to the fiber. In bridging theory, the fiber transfers back the load that it carries to other part of the matrix. Eventually, another parallel macro crack is formed. This process is repeating and leads to the formation of multiple cracking.

In hydrated water, there are free water, chemically combined water and also gel water. Free water can be classified as the water that fills the capillaries and outside the surface forces of the solid particles. Chemically combined water is the water that used in hydration process. And the gel water is the adsorbed water and held between the C-S-H sheets surfaces. From these three phases of water, only free water is evaporated. In connection to the PVA fiber addition, it does not affect water evaporation as reported by Thanasak and Antoine (2005) [6].

Fiber reinforced concrete undergoes trilinear deformation behaviour as shown in **Figure 2.4**. Point A on the load-deflection diagram represents the first cracking load or can be classified as first-crack strength. It is the same load level where a non-reinforced concrete element cracks. In the other words, the slope OA in the load-deflection diagram is the same for both plain and fiber reinforced concrete.



**Figure 2.4 :** Schematic load-deflection relationship of fiber reinforced concrete

During cracking, the applied load is transferred to the fibers which bridge and tie the crack from opening further. As the fibers deform, additional narrow cracks develop and continued cracking of the matrix takes place until the maximum load reaches point B of the load-deflection diagram. In this stage, debonding and pullout of some of the fibers occur. However, the yield strength of most of the fibers is not reached.

For the slope BC of the load-deflection diagram, matrix cracking and fiber pullout continue. The fibers may fail by yielding or by fracture of the fibers if the fibers are long enough to be able to maintain their bond with the surrounding gel depending on their size and spacing.

#### **2.4 Comparison of PVA, PP and carbon fibers**

In term of modulus, PVA and carbon fibers are 4 and 30 times greater than polypropylene (PP). Carbon fibers have the highest tensile strength compared to PVA and PP fibers. However, PVA fiber has very high bond to concrete. Even though the carbon fibers have the highest tensile strength, corrosion might reduce the strength over time. In addition to that, brown spots might appear on the concrete surface after sometime.



## 2.5 Splitting Tensile Strength

The splitting tensile strength of a concrete cylinder can be computed by using the following formula:

$$T = \frac{2P}{\pi ld}$$

where,

$T$  = Tensile splitting strength in kPa

$P$  = Applied load at the time of failure of the specimen in kN

$l$  = Length of the cylindrical specimen in m

$d$  = Diameter of the specimen in m

## 2.6 Concrete Mixing

Cengiz and Okan (2007) mentioned about how they did the concrete mixing for their research [16]. The following procedure was used:

1. The gravel and sand were placed in a concrete mixer and dry mixed for 1 min.
2. The cement and fiber were spread and dry mixed for 1 min.
3. 90% water was added and mixed for approximately 2 min.
4. The remaining 10% water and plasticizer were added and mixed for 3 min.

However, there was fluctuation in the compressive strength of cube concrete specimens produced. Regarding this matter, they have stated that this fluctuation might be due to the physical difficulties in providing a homogeneous distribution of the fiber.



Other researchers, Sivakumar and Santhanam (2007) had applied roughly the same procedure with some modification [17]. The procedure that they used is as follows:

1. Coarse aggregate, fine aggregate, cement, and silica fume were dry mixed for 2 min.
2. The mixture of superplasticizer and water was mixed thoroughly to the mixer.
3. Fibers were uniformly dispersed by hand into the mixer to achieve uniform distribution and mixed for 4 min.

From these two concrete mixing procedures, dry mixing consisting of coarse aggregate, fine aggregate, cement is made first before water is added into the mix. The fiber should be distributed uniformly into the concrete mix. Since the PVA fiber is solid, it is advised that the PVA fiber is to be included in the dry mixing. For superplasticizer, it should be mixed in the water first before being poured into the concrete mix.

Instead of pouring all the fiber at a time, Edward G. Nawy has stated the different procedure by mixing the fiber part by part as follows:

1. Part of the fiber and aggregate are blended before charging into the mixer.
2. Fine and coarse aggregate are blended in the mixer, then more fibers are added at the mixing speed. Lastly, cement and water are added simultaneously or cement followed immediately by water and additives.
3. The balance of the fiber is added to the previously charged constituents. The remaining cementitious materials and water are added.
4. Mixing is continued as required by normal practice.



## CHAPTER 3

### METHODOLOGY

#### 3.1 Planning and details

Main test	: Tensile strength test
Additional tests	: Slump test and SEM
Extra investigation	: Fiber dispersion by different mixing procedures
Sample	: Concrete grade 30
Type of sample	: Cylinder
Size of sample	: 200 x 100
Test days	: 3 <sup>rd</sup> day, 7 <sup>th</sup> day, 28 <sup>th</sup> day and 60 <sup>th</sup> day

No of samples is shown in **Table 3.1**.

**Table 3.1** : No of samples for each test

PVA volume percentages, $V_f$ (%)	Test days			
	3 <sup>rd</sup> day	7 <sup>th</sup> day	28 <sup>th</sup> day	60 <sup>th</sup> day
0	3	3	3	3
0.5	3	3	3	3
1.0	3	3	3	3
1.5	3	3	3	3
2.0	3	3	3	3

Scanning Electron Microscope (SEM) test would be conducted and the following subjects are to be magnified:

- 1) Bonding between PVA fiber and cement.
- 2) The original surface of PVA fiber.
- 3) The surface of PVA fiber in the concrete at 30<sup>th</sup> day, 60<sup>th</sup> day and 90<sup>th</sup> day.



The type of fiber that is used in this project is RF 4000 manufactured by Kuraray.Co.Ltd. which is a Japanese company. The properties of the fibers are indicated in **Table 3.2** as follows:

**Table 3.2:** Properties of PVA fiber (RF 4000)

Fiber type	Diameter (mm)	Thickness (dtex)	Cut length (mm)*	Tensile Strength (N/mm <sup>2</sup> )	Elongation (%)	Young's Modulus (kN/mm <sup>2</sup> )	Specific Gravity	Primary Applications
RF4000	0.66	4444	30	900 (0.9GPa)	7	23	1.3	Aggregate above 3/4" (20mm) and shotcrete

### 3.2 Mix Design (British Standard)

Target compressive design at 28 days = 30 MPa

Water/cement ratio is 0.63.

Slump is 60-180 mm and maximum aggregates size is 20mm uncrushed. Hence, the water content is 195 kg/m<sup>3</sup>.

The cement content:

$$\begin{aligned} \text{Water cement / wc ratio} &= 195 / 0.63 \\ &= 309.52 \text{ kg/m}^3 \end{aligned}$$

Fresh density of concrete mix is 2361.11 kg/m<sup>3</sup>.

Total aggregates content:

$$\begin{aligned} &= 2361.11 \text{ kg/m}^3 - 309.52 \text{ kg/m}^3 - 195 \text{ kg/m}^3 \\ &= 1865.59 \text{ kg/m}^3 \end{aligned}$$

Fine aggregates content is 38.5% from total aggregates content:

$$\begin{aligned} &= 0.385 \times 1865.59 \text{ kg/m}^3 \\ &= 714.79 \text{ kg/m}^3 \end{aligned}$$

Coarse aggregates content:

$$\begin{aligned} &= (1 - 0.385) \times 1865.59 \text{ kg/m}^3 \\ &= 1141.80 \text{ kg/m}^3 \end{aligned}$$





The design can be summarized as follows:

W/C	= 0.63
Cement	= 309.52 kg/m <sup>3</sup>
Coarse aggregates	= 1141.80 kg/m <sup>3</sup>
Fine aggregates	= 714.79 kg/m <sup>3</sup>
Water content	= 195.00 kg/m <sup>3</sup>
Superplasticizer	= 3.00 l/m <sup>3</sup>

For each sample 200x100 cylinder ( 0.00157 m<sup>3</sup>):

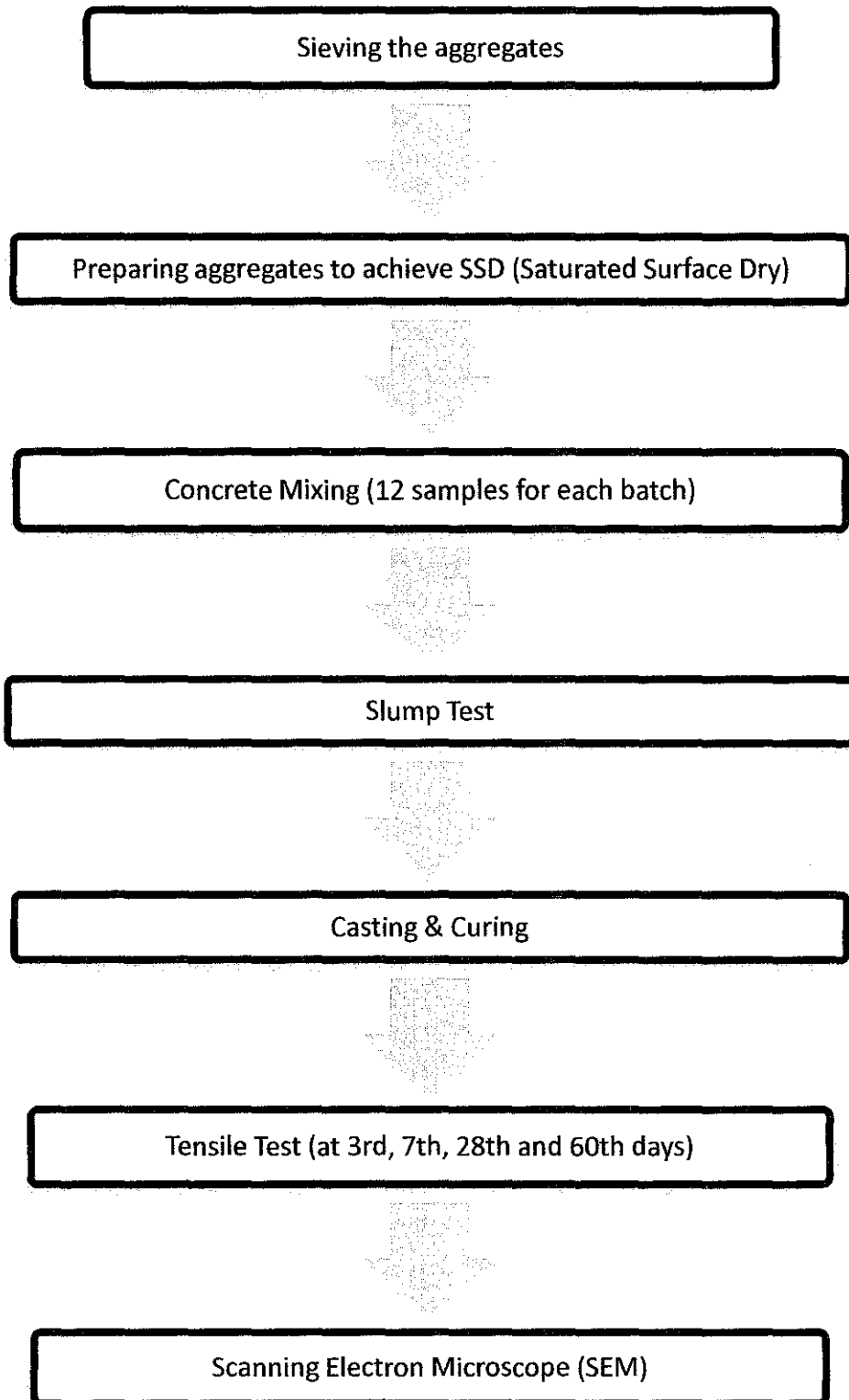
Cement	= 309.52 kg/m <sup>3</sup> x 0.00157 m <sup>3</sup> = 0.4862 kg
Coarse aggregates	= 1141.80 kg/m <sup>3</sup> x 0.00157 m <sup>3</sup> = 1.7935 kg
Fine aggregates	= 714.79 kg/m <sup>3</sup> x 0.00157 m <sup>3</sup> = 1.1228 kg
Water content	= 195.00 kg/m <sup>3</sup> x 0.00157 m <sup>3</sup> = 0.3063 kg
Superplasticizer	= 3.00 l/m <sup>3</sup> x 0.00157 m <sup>3</sup> = 0.0047 l

Type of superplasticizer used : Sikament-NN (detailed in **Appendix E**)



### 3.3 Flow Chart of Methodology

The main project procedure is divided into several phases as shown below:



**Figure 3.1 :** Flow chart of the main procedure of project



### 3.4 Sieving

#### 3.4.1 Coarse Aggregate

1. The aggregates are filled into the sieving pan with 20mm holes. Sieving pans are shown in **Figure 3.2**.
2. The sieving process continues for 5 minutes.
3. All aggregates that pass the sieve are taken for making the specimens.



**Figure 3.2** : Sieving pans

#### 3.4.2 Fine Aggregate

1. The fine aggregate as shown in **Figure 3.3** is dried in room temperature.
2. Sieving pan of 2mm holes is used to sieve the fine aggregate.
3. All aggregates that pass the sieve are taken for making the specimens.



**Figure 3.3** : Fine aggregate

### 3.5 Preparing SSD

1. The aggregates are rinsed with clean water to remove lumps and coatings on particles.
2. The aggregates are soaked in water for  $24 \pm 2$  hours.
3. The aggregates are then rewashed to remove slaked material.
4. After rewashing, the aggregates are left in room temperature as shown in **Figure 3.4** for several hours until the surface of the aggregates are dry.



**Figure 3.4** : SSD aggregate

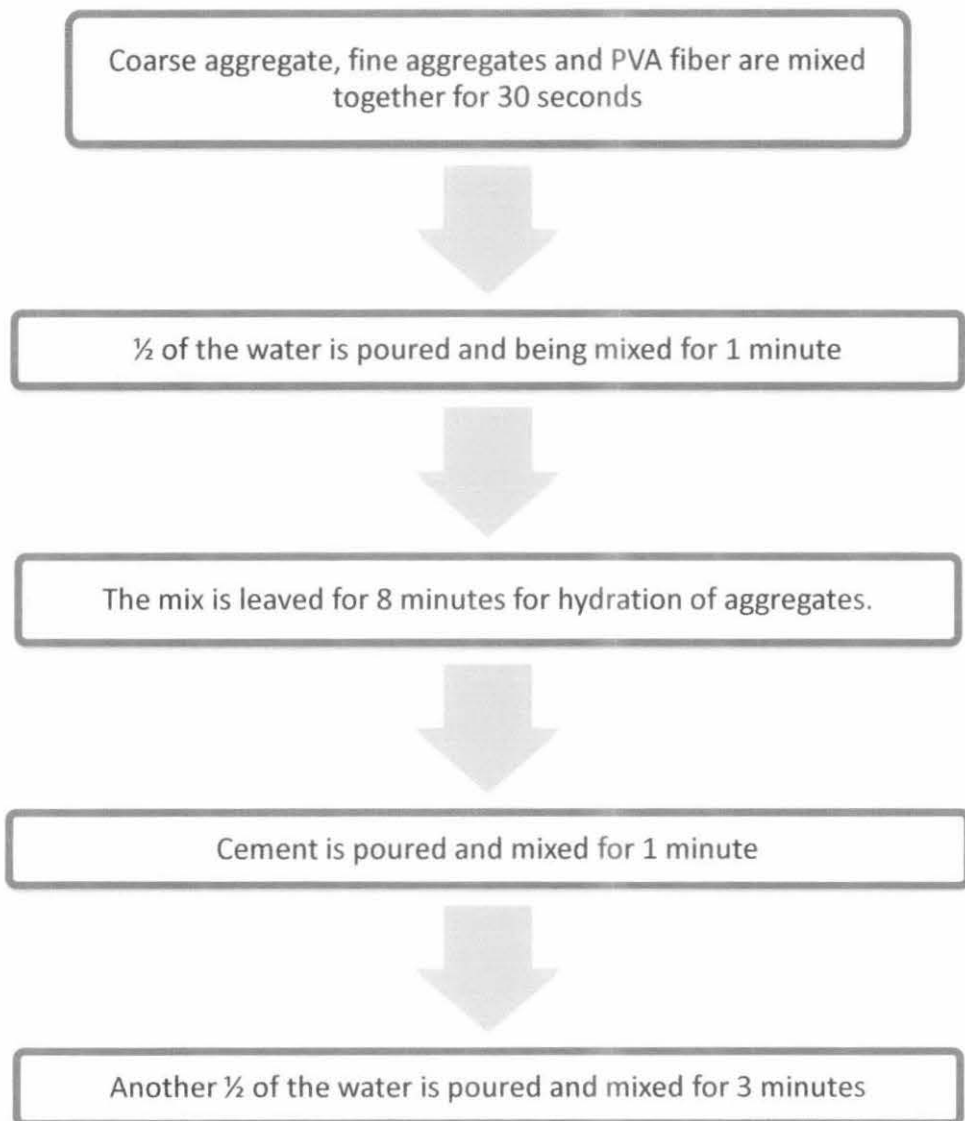


### 3.6 Concrete mixing

There are 3 different methods of concrete mixing used in analyzing the distribution of PVA fiber inside the concrete specimens. The methods are dry mixing, wet mixing and improved wet mixing.

#### 3.6.1 Dry mixing

The dry mixing procedure is shown as follows:

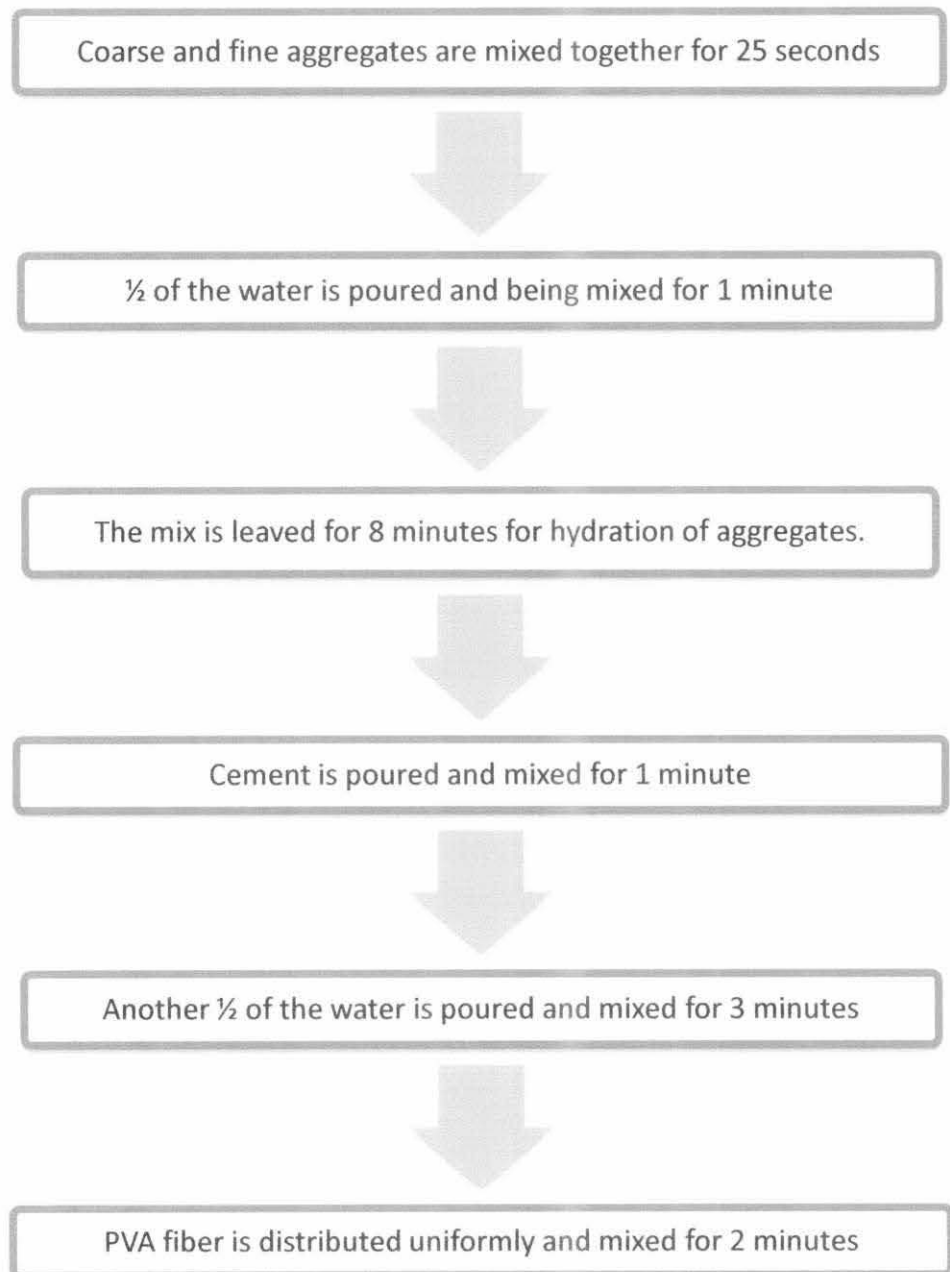


**Figure 3.5 :** Flow chart of wet mixing procedure



### 3.6.2 Wet mixing

The wet mixing procedure is shown as follows:

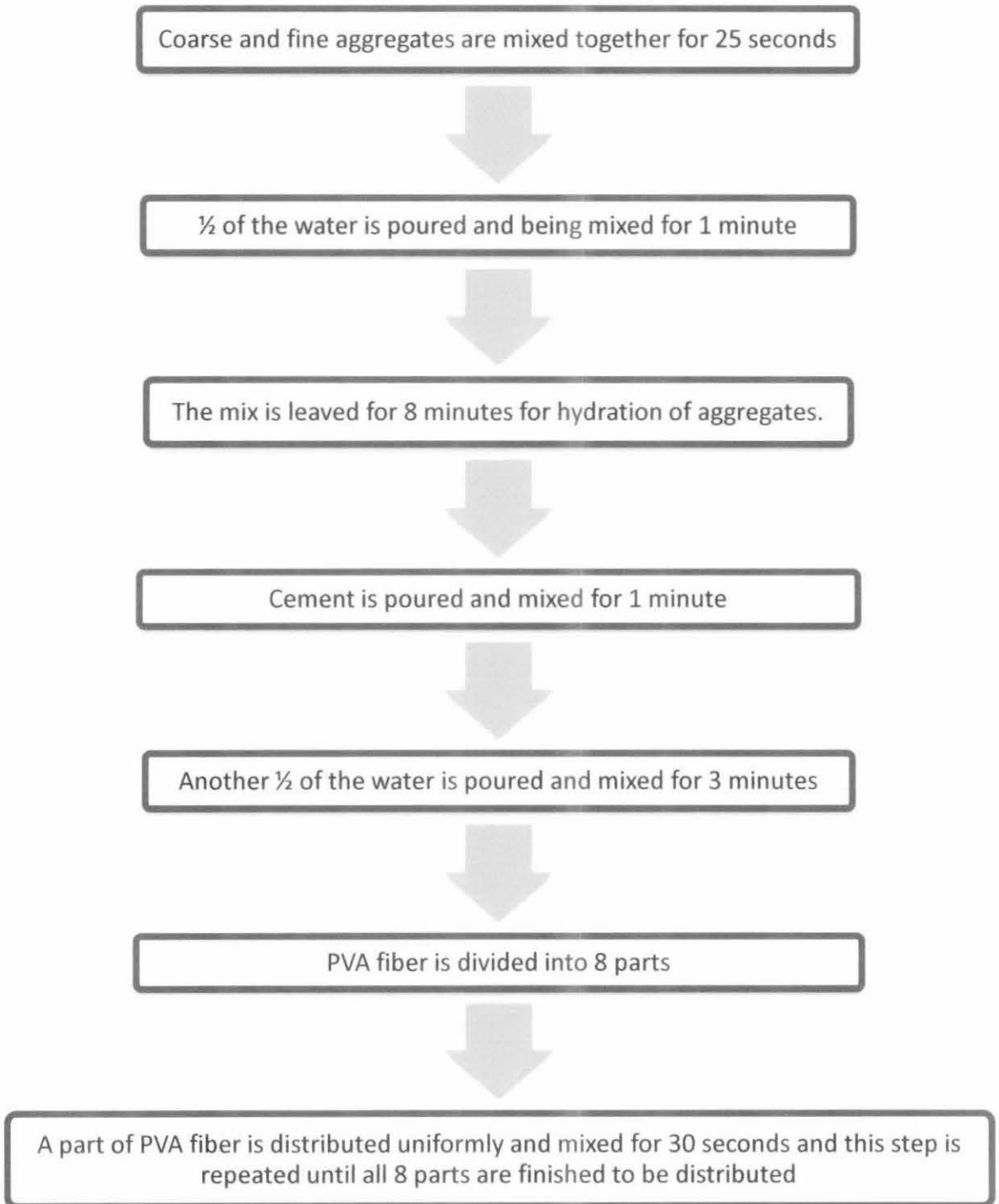


**Figure 3.6 :** Flow chart of wet mixing procedure



### 3.6.2 Improved wet mixing

The improved wet mixing procedure is shown as follows:



**Figure 3.7 :** Flow chart of improved wet mixing procedure



### 3.7 Slump Test

1. The mould is moisturized with water.
2. The mould is placed on a smooth surface with a smaller opening at the top.
3. The mould is then filled with concrete in 3 layers. Each layer is tamped 35 times with a standard 16mm (5/8 inch) diameter steel rod, rounded at the end, and the top surface is struck off.
4. After filling, the cone is immediately lifted slowly as shown in **Figure 3.8**. The decrease in the height of the slumped concrete is called slump, and is measured to the nearest 5mm (the decrease is measured to the highest point according to BS 1881:Part 102:1983)

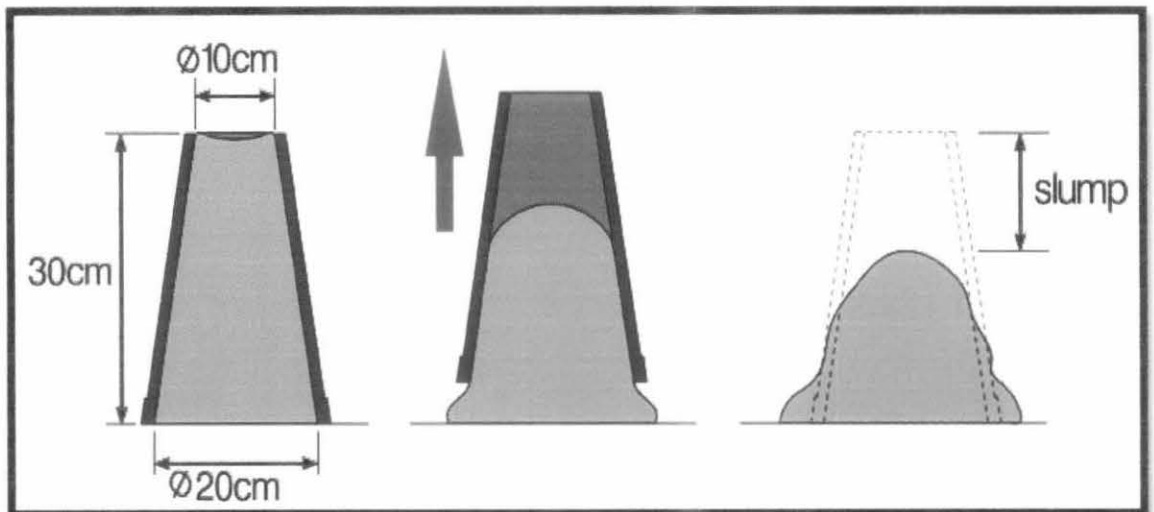


Figure 3.8 : Slump test illustrations



### 3.8 Casting & curing

1. The moulds (as shown in **Figure 3.9**) and its base are clamped together during casting to prevent leakage of mortar.
2. The fresh concrete mix is cast by using 200x100 cylinder moulds.
3. Before assembling the moulds, its mating surface is covered with oil to prevent the development of bond between the mould and the concrete.
4. Each mould is filled with in 3 layers. Each layer is compacted by a vibrating hammer or using a vibrating table or by not fewer than 35 strokes of a 25mm square steel punner.
5. The cube samples are stored undisturbed for 24 hours at room temperature.
6. Then, the samples are stripped from the moulds and put in the water for further curing.



**Figure 3.9** : Cylinder moulds (200x100)





### 3.9 Tensile Test (Splitting Tensile Test)

1. The sample, while still wet, is placed in specimen holder (as shown in **Figure 3.10**).
2. 2 pieces of hardboards are placed between the holder and the sample (as shown in **Figure 3.11**).

**NOTE :** The size of the hardboard is 4mm thick and 15mm wide as specified by BS 1881:117:1983.

3. The load on cube is applied at a constant rate of stress equal to 0.2-0.4 MPa/second until it fails.
4. The maximum load before the cube fails is taken and the tensile strength is calculated by using the following equation:

$$T = \frac{2P}{\pi ld}$$

where,

$T$  = Tensile splitting strength in kPa

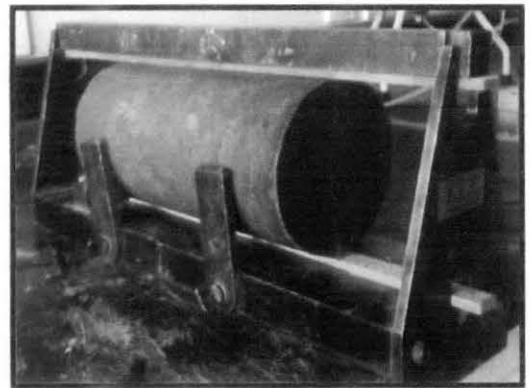
$P$  = Applied load at the time of failure of the specimen in kN

$l$  = Length of the cylindrical specimen in m

$d$  = Diameter of the specimen in m



**Figure 3.10 :** Specimen holder for tensile strength test of cylinder.



**Figure 3.11 :** The arrangement for tensile strength test of cylindrical sample.

### 3.10 Key Milestone

The progress of **Final Year Project 1** and **Final Year Project 2** are represented in separate bar charts.

#### 3.10.1 Milestone for Final Year Project 1

The progress of **Final Year Project 1** is shown in **Chart 3.1**.

**Chart 3.1** : Milestone for Final Year Project 1

No.	Detail/ Week	1	2	3	4	5	6	7	8	9	10	11	12	13	14
1	Selection of Project Topic	■													
	-Propose Topic														
	-Topic assigned to students														
2	Research Work		■	■											
	-Introduction														
	-Objective														
	-List of references/literature														
	-Project planning														
3	Submission of Preliminary Report			●											
4	Project Work				■	■	■	■							
	-Reference/Literature														
	-Practical/Laboratory Work														
5	Submission of Progress Report								●						
6	Project work continue								■	■	■	■	■	■	■
	-Practical/Laboratory Work														
7	Submission of Interim Report Final Draft											●			
8	Oral Presentation														
9	Submission of Interim Report													●	

● Milestone  
 ■ Process

### 3.10.2 Milestone for Final Year Project 2

The progress of **Final Year Project 2** is shown in **Chart 3.2**.

**Chart 3.2 : Milestone for Final Year Project 2**

No.	Detail/ Week	1	2	3	4	5	6	7	8	9	10	11	12	13	14
1	Project Work Continue	■	■	■	■	■									
2	Submission of Progress Report 1						●								
3	Project Work Continue					■	■	■	■	■					
4	Submission of Progress Report 2										●				
5	Seminar (compulsory)								■	■	■	■	■		
5	Project work continue									■	■				
6	Poster Exhibition										●				
7	Submission of Dissertation (soft bound)											●			
8	Oral Presentation														
9	Submission of Project Dissertation (Hard Bound)													●	

● Milestone  
 ■ Process



## **CHAPTER 4**

### **HSE REQUIREMENTS**

#### **4.1 Introduction**

In order to avoid any accident that might occur in the concrete laboratory, HSE regulation must be followed at all time. The HSE requirements include the procedure on how to operate machines in the laboratory, the actions which are forbidden and also safety measures that need to be considered for any activity.

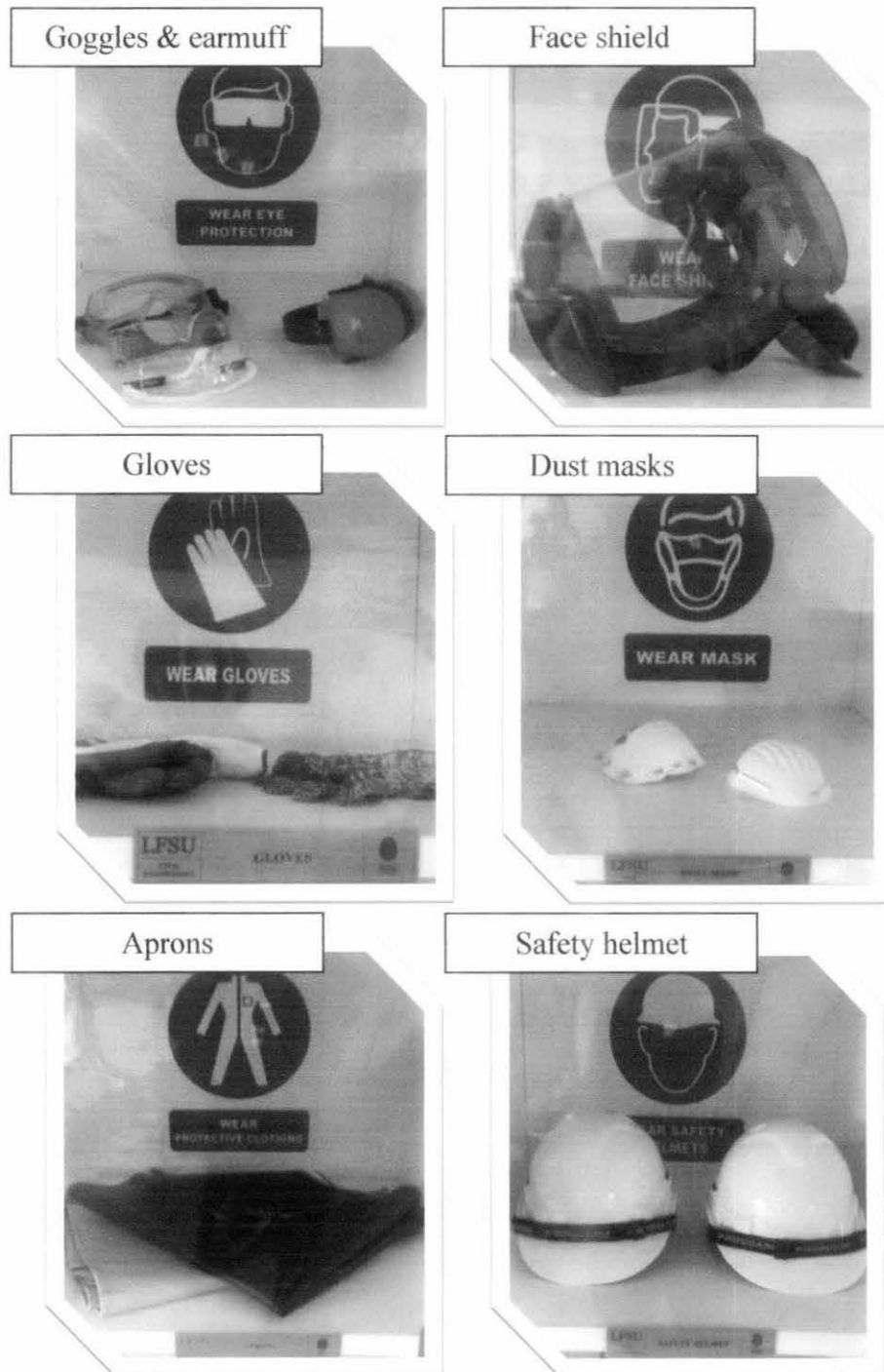
In the laboratory, students are given HSE briefing first by the technicians before starting any work. This is mandatory to all students and failing to attend the briefing would make any work which need to be done becomes illegal. Before starting any work, students are required to do HSE analysis regarding the activities which will be completed in the laboratory.

Safety equipments are provided inside the laboratory and need to be used for any activity that needs to be conducted in the laboratory. First aid also provided for any minor injury and needs to be reported to technician.



## 4.2 Safety Equipments Provided in Concrete Laboratory

The safety equipments that provided in the concrete laboratory are shown in **Figure 4.1**:



**Figure 4.1** : Safety Equipments Provided in Concrete Laboratory

### 4.3 HSE Analysis

The Health Safety and Environment in the concrete laboratory is summarized in **Table 4.1**.

**Table 4.1** : The Health Safety and Environment in the concrete laboratory

<b>INSTRUMENT/MATERIAL</b>	<b>ACTIVITY</b>	<b>HAZARDS</b>	<b>SAFE PROCEDURE</b>
Sieving Machine	Switching the machine	Electricity Shock	Wear gloves & rubber shoes
	Sieving aggregates	Hearing Hazard	Wear earmuff
Concrete Mixer	Switching the machine	Electricity Shock	Wear gloves & rubber shoes
	Mixing concrete	Body Injuries	Always close the container during the mixing process
Compression Machine	Switching the machine	Electricity Shock	Wear gloves & rubber shoes
	Conducting tests	Body Injuries	Isolate the testing zone by closing the gate of the machine
Vibrator	Switching the machine	Electricity Shock	Wear gloves & rubber shoes
	Vibrating the matrix	Electricity Shock	Wear gloves & rubber shoes
Cement	Handling the cement	Harmful to lung if inhaled	Wear dust mask



## CHAPTER 5

### RESULT AND DISCUSSION

#### 5.1 Slump Test

The results of slump test of fresh concrete without superplasticizer and fresh concrete with superplasticizer are shown in **Table 5.1** and **Table 5.2** respectively.

**Table 5.1** : Results of slump test of fresh concrete without superplasticizer

Mix	Slump (mm)
PVA 0%	150.0
PVA 1%	62.00
PVA 2%	25.00
PVA 3%	0.000

**Table 5.2** : Results of slump test of fresh concrete with superplasticizer

Mix	Slump (mm)
PVA 1%	97.50
PVA 2%	41.00
PVA 3%	30.00

The result shows that the slump of the fresh concrete decreases uniformly as the PVA fiber content in the concrete mix increases. Much stiffer mix is formed because the skeleton blocking of the fiber constraints the free flow of the mix. In order to achieve recommended slump, superplasticizer is added into the concrete mix and the slump increases as shown in **Table 5.2**.

## 5.2 Tensile Strength Test Result

The tensile test result of the project is shown in **Table 5.3**, **Table 5.4**, **Table 5.5**, **Table 5.6** and **Table 5.7**.

**Table 5.3** : Maximum tensile load capacity and tensile strength for 0% fiber content

3rd			7th			28th			60th		
1	max load	70.400	1	max load	71.800	1	max load	118.000	1	max load	128.700
	stress	2.241		stress	2.287		stress	3.759		stress	4.099
2	max load	60.300	2	max load	92.500	2	max load	121.100	2	max load	134.100
	stress	1.920		stress	2.945		stress	3.856		stress	4.269
3	max load	57.900	3	max load	77.700	3	max load	117.300	3	max load	124.700
	stress	1.844		stress	2.474		stress	3.735		stress	3.970
Average	max load	62.867	Average	max load	80.667	Average	max load	118.800	Average	max load	129.167
	stress	2.002		stress	2.569		stress	3.783		stress	4.113

**NOTE** : Unit for max load and stress are kN and N/mm<sup>2</sup> respectively.

**Table 5.4** : Maximum tensile load capacity and tensile strength for 0.5% fiber content

3rd			7th			28th			60th		
1	max load	81.700	1	max load	86.200	1	max load	134.700	1	max load	151.200
	stress	2.601		stress	2.744		stress	4.287		stress	4.812
2	max load	69.800	2	max load	98.200	2	max load	121.700	2	max load	159.600
	stress	2.221		stress	3.127		stress	3.874		stress	5.082
3	max load	81.700	3	max load	107.500	3	max load	128.200	3	max load	134.800
	stress	2.610		stress	3.422		stress	4.081		stress	4.289
Average	max load	77.733	Average	max load	97.300	Average	max load	128.200	Average	max load	148.533
	stress	2.477		stress	3.098		stress	4.081		stress	4.728

**NOTE** : Unit for max load and stress are kN and N/mm<sup>2</sup> respectively.



**Table 5.5 : Maximum tensile load capacity and tensile strength for 1.0% fiber content**

3rd			7th			28th			60th		
1	max load	95.000	1	max load	114.600	1	max load	152.300	1	max load	159.300
	stress	3.023		stress	3.647		stress	4.847		stress	5.072
2	max load	105.700	2	max load	120.700	2	max load	147.800	2	max load	157.300
	stress	3.364		stress	3.843		stress	4.706		stress	5.008
3	max load	96.800	3	max load	119.200	3	max load	153.800	3	max load	171.500
	stress	3.081		stress	3.793		stress	4.894		stress	5.458
Average			Average			Average			Average		
	max load	99.167		max load	118.167		max load	151.300		max load	162.700
	stress	3.156		stress	3.761		stress	4.816		stress	5.179

**NOTE :** Unit for max load and stress are kN and N/mm<sup>2</sup> respectively.

**Table 5.6 : Maximum tensile load capacity and tensile strength for 1.5% fiber content**

3rd			7th			28th			60th		
1	max load	91.600	1	max load	114.300	1	max load	157.000	1	max load	163.200
	stress	2.915		stress	3.637		stress	4.998		stress	5.195
2	max load	110.200	2	max load	111.700	2	max load	144.600	2	max load	158.100
	stress	3.508		stress	3.556		stress	4.602		stress	5.032
3	max load	95.100	3	max load	113.100	3	max load	151.300	3	max load	157.300
	stress	3.027		stress	3.600		stress	4.816		stress	5.007
Average			Average			Average			Average		
	max load	98.967		max load	113.033		max load	150.967		max load	159.533
	stress	3.150		stress	3.598		stress	4.805		stress	5.078

**NOTE :** Unit for max load and stress are kN and N/mm<sup>2</sup> respectively.

**Table 5.7 :** Maximum tensile load capacity and tensile strength for 2.0% fiber content

3rd			7th			28th			60th		
1	max load	89.100	1	max load	100.400	1	max load	121.200	1	max load	129.200
	stress	2.837		stress	3.197		stress	3.858		stress	4.113
2	max load	81.400	2	max load	97.200	2	max load	114.900	2	max load	118.700
	stress	2.590		stress	3.093		stress	3.658		stress	3.779
3	max load	102.100	3	max load	108.100	3	max load	117.300	3	max load	127.900
	stress	3.251		stress	3.442		stress	3.734		stress	4.072
Average	max load	90.867	Average	max load	101.900	Average	max load	117.800	Average	max load	125.267
	stress	2.893		stress	3.244		stress	3.750		stress	3.988

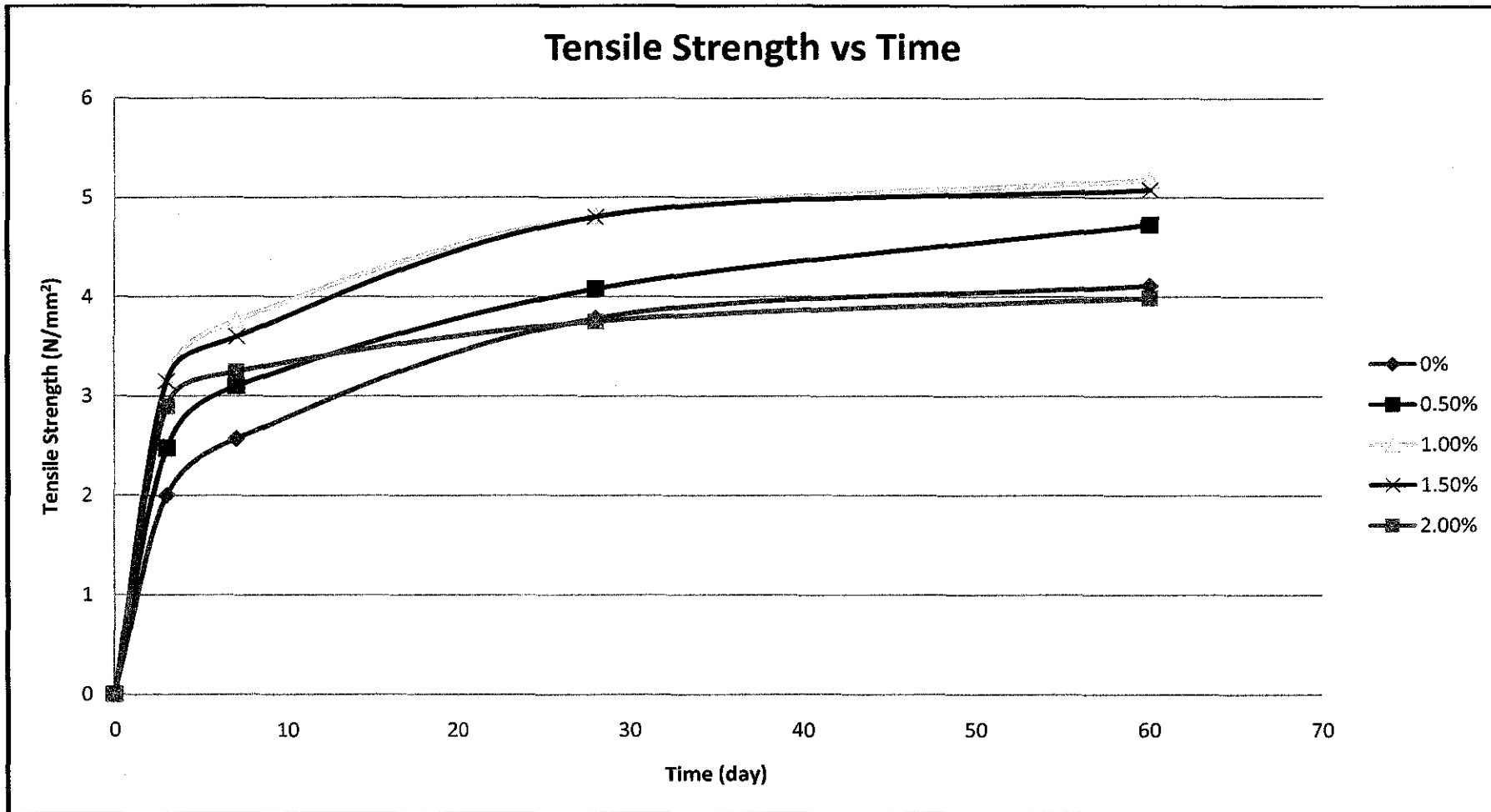
**NOTE :** Unit for max load and stress are kN and N/mm<sup>2</sup> respectively.

The tensile strength of PVA fiber reinforced concrete is summarized in **Table 5.8**.

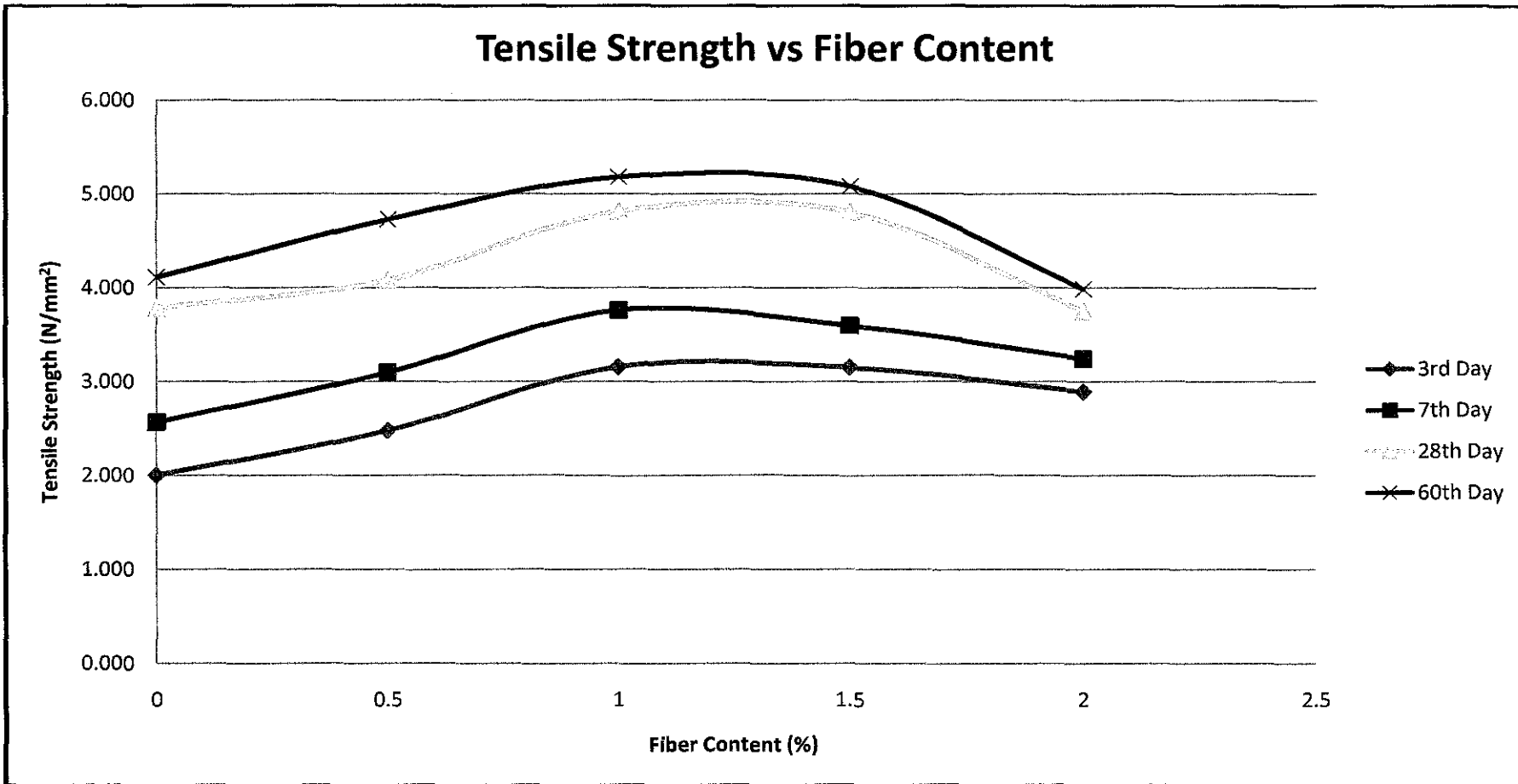
**Table 5.8 :** The summarized result of tensile strength test

Time (day)	Fiber Content (%)				
	0	0.5	1	1.5	2
3	2.002	2.477	3.156	3.150	2.893
7	2.569	3.098	3.761	3.598	3.244
28	3.783	4.081	4.816	4.805	3.750
60	4.113	4.728	5.179	5.078	3.988

The summarized tensile strength result is represented by graphs in **Figure 5.1** and **Figure 5.2**.



**Figure 5.1** : Tensile strength development of PVA reinforced concrete.



**Figure 5.2 :** The effect of PVA fiber to the tensile strength of the concrete.



**Figure 5.1** shows the tensile strength development of concrete with PVA fiber content of 0%, 0.5%, 1.0%, 1.5% and 2.0%. From the graph, the tensile strength of concrete which reinforced with 1.0% is the highest with the improvement of tensile strength of 27% of normal concrete (0% fiber content). This value somehow can be improved further if better fiber distribution is achieved.

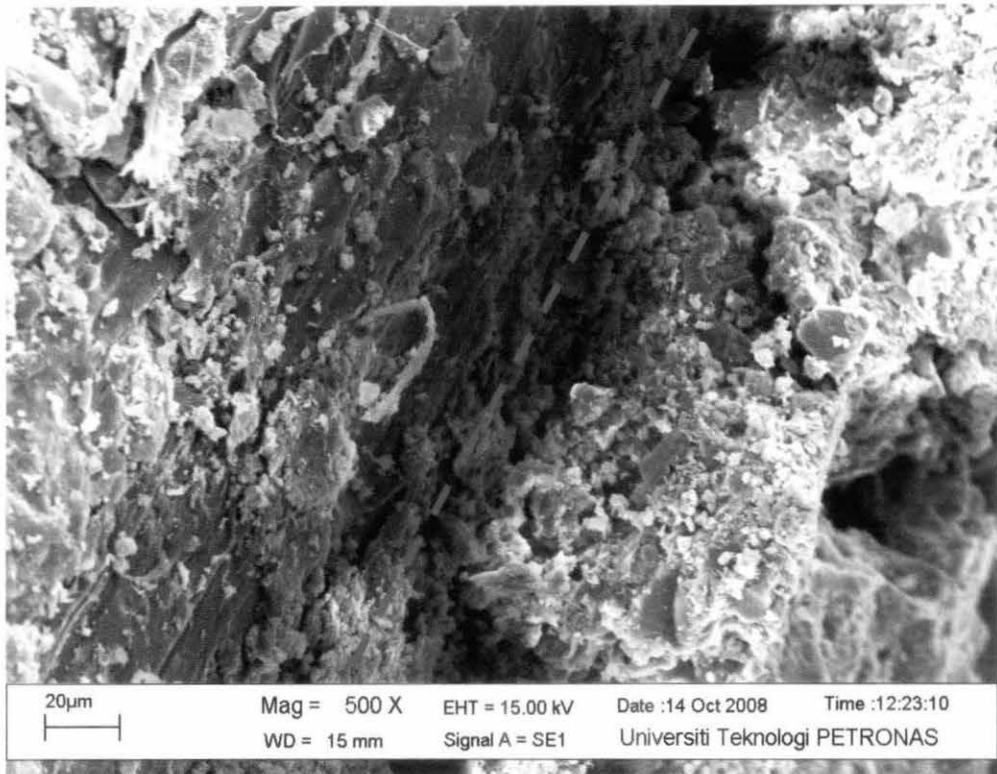
**Figure 5.2** shows the effect of PVA fiber to the tensile strength of concrete. From the graph, the tensile strength of concrete increases as the fiber content increases from 0% to 1.0%. However, the tensile strength of concrete decreases as the PVA fiber content exceeds 1.0%. It is because of the excessive air entrapment inside the concrete when the PVA fiber content is more than the optimum value. The optimum value of PVA fiber content is in the range of 1.0% to 1.5%.

### **5.3 Scanning Electron Microscope (SEM)**

Scanning Electron Microscope (SEM) is used to identify the bonding between the PVA fiber and the cement, and also to analyze the changes on the PVA fiber surface with time.

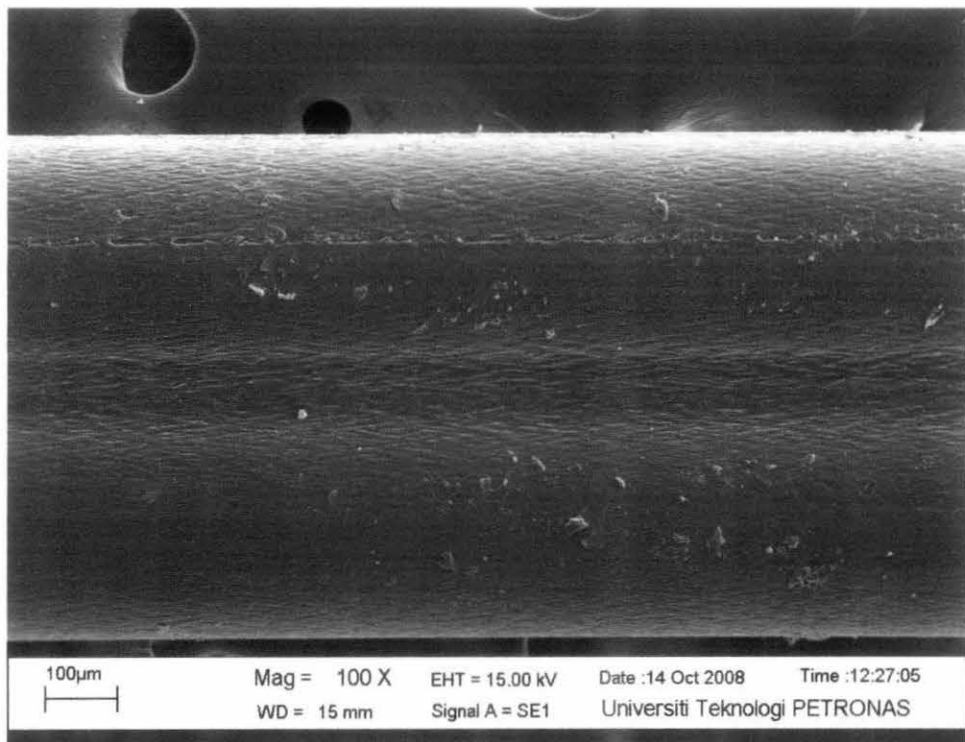
#### **5.3.1 Bonding between PVA fiber and cement**

**Figure 5.3** shows the connection between the PVA fiber and the cement. The red line is the location where the PVA fiber (at the left) is connected to the cement (at the right). It proves that the PVA fiber has molecular bonding with the cement since the gap between the PVA fiber and the cement cannot be seen even though it has been magnified up to 500 times.

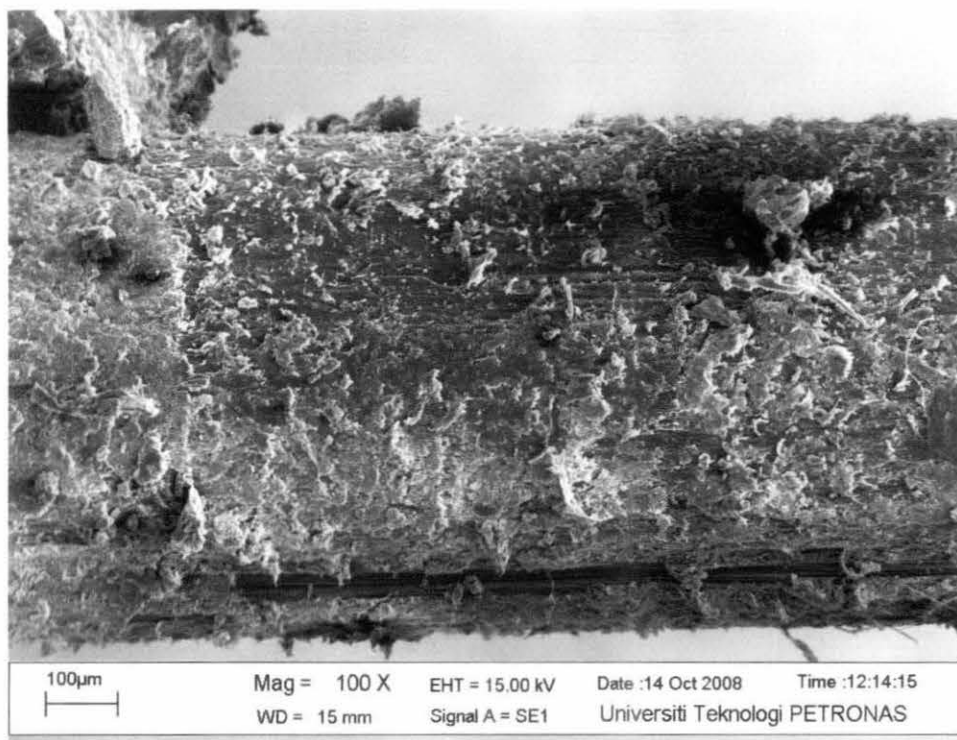


**Figure 5.3 :** The bond between the PVA fiber and cement.

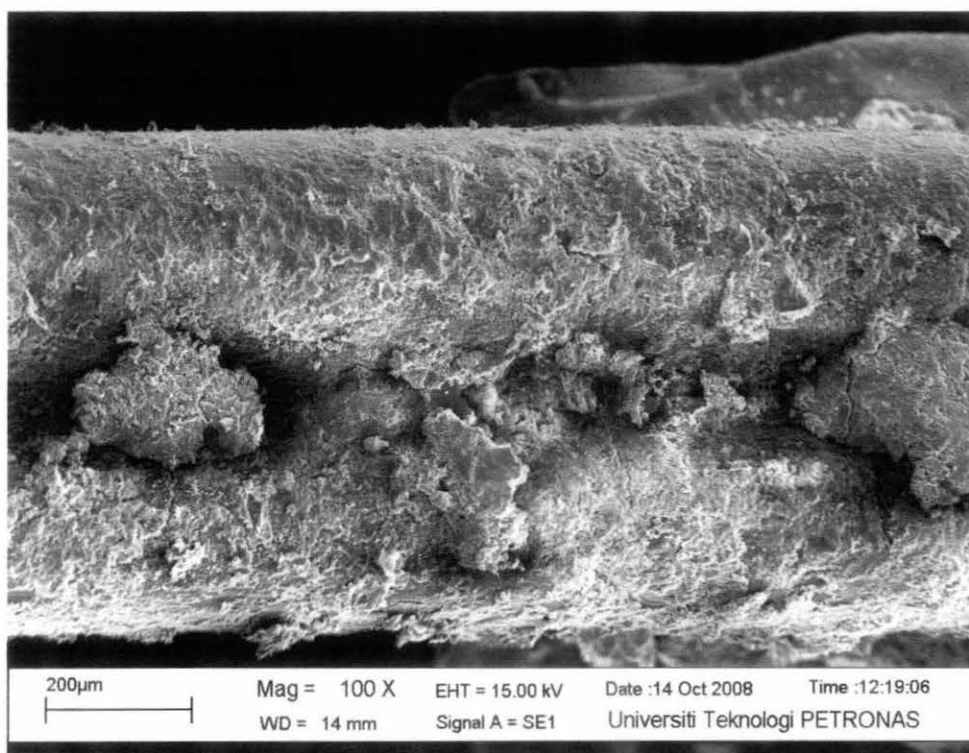
### 5.3.2 Changes of PVA fiber surface in concrete with time



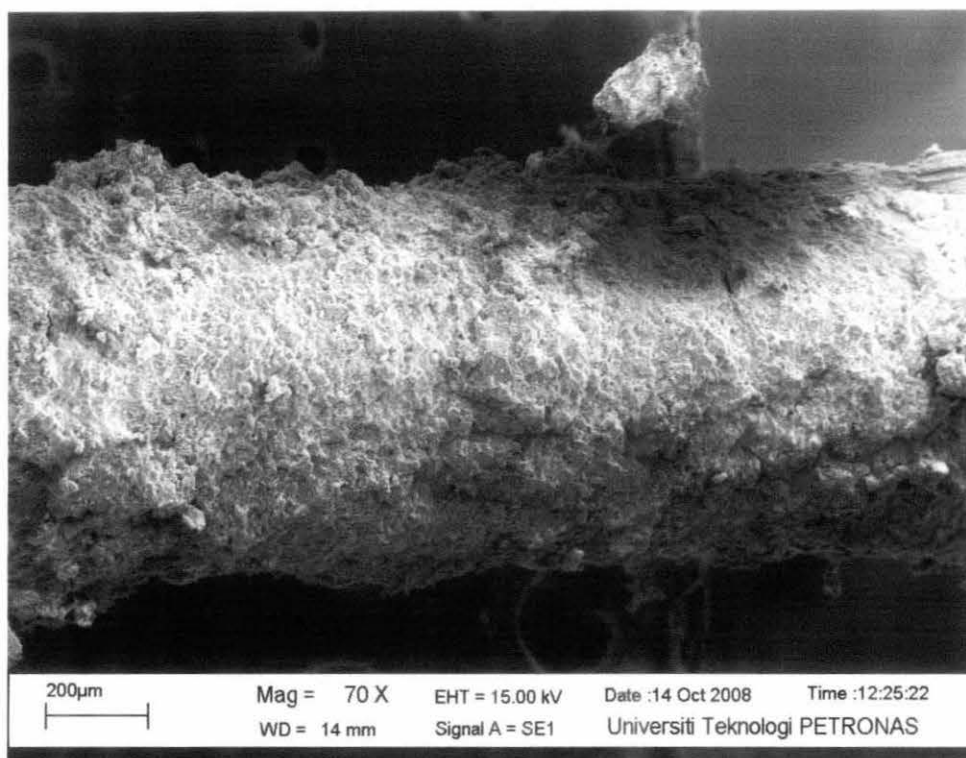
**Figure 5.4 :** Original PVA fiber surface (100X magnification).



**Figure 5.5 :** PVA fiber surface after 30 days in concrete (100X magnification).



**Figure 5.6 :** PVA fiber surface after 60 days in concrete (100X magnification).



**Figure 5.7 :** PVA fiber surface after 90 days in concrete (70X magnification).

**Figure 5.4 to 5.7** show the changes on the surface of PVA fiber in time. These figures prove that there is chemical reaction between the PVA fiber and the concrete. Since the concrete is added with superplasticizer, the reaction can be either with the cement or superplasticizer.





## 5.4 Mixing Process

In preparing the fiber reinforced concrete, the most important thing to be considered is the fiber distribution in the mix. Initially, there are 2 types of concrete mixings have been done which are dry mixing and wet mixing. In dry mixing process, the fine aggregate, coarse aggregate and the fiber are mixed first followed by cement and water. For this type of mixing process, it is not suitable since the concrete mixer is a drum type as shown in **Figure 5.8**.



**Figure 5.8** : Drum type concrete mixer.

By applying dry mixing using this type of mixer, the aggregates and fiber are influenced with the centrifugal force that pulls the aggregates and fiber to the edge of the drum. After 30 seconds of mixing, it is found out that the fine aggregate and the fiber concentrated at the edge of drum. The coarse aggregate remains at all over the drum. This inhomogeneous mix leads to the poor fiber distribution in the sample.

Second type of mixing process is wet mixing by which the fiber is added at the end of the mixing process. The centrifugal force due to rapid rotation does not significantly



affect the concrete since the mortar holds the aggregates and fiber. However, since the fiber is poured all in one time on the surface of the concrete, the fiber concentration is high at the concrete surface initially and also leads to the poor fiber distribution in the sample.

The wet mixing process is then improved by dividing the fiber into 8 parts. The fiber is poured part by part with 30 seconds mixing in between parts. This procedure improves the fiber distribution. It has been proposed that the fiber is poured bit by bit while mixing takes place to have the best fiber distribution. But it cannot be done since the blades that mix the concrete attached to the gate that closes the drum.

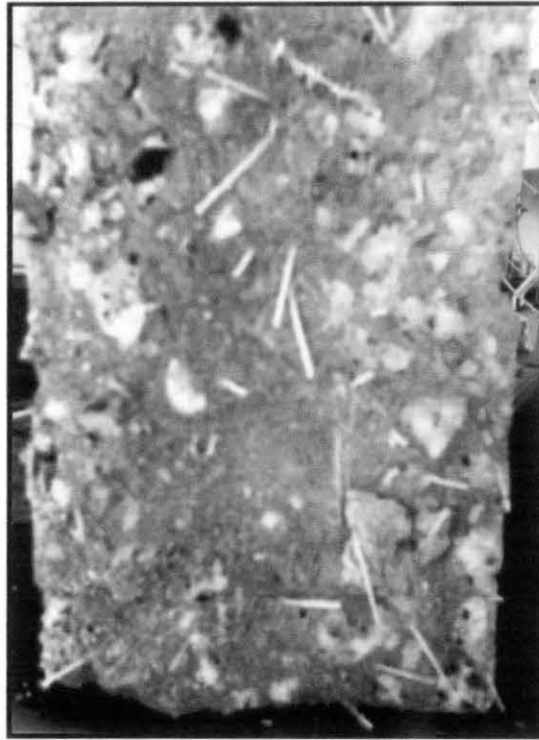
### 5.5 Vibrating

The other sample preparation procedure that affects the fiber distribution is the use of vibrator. Vibrator (as shown in **Figure 5.9**) is used to remove the air inside the mould.



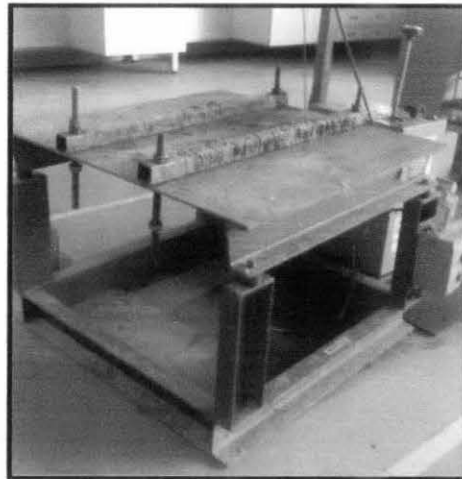
**Figure 5.9** : Vibrator

The vibrator is merged at the center of the mould during the vibrating process. As the result, the coarse aggregate is concentrated at the outer side of the specimen as shown in **Figure 5.10**. It reduces the strength of the concrete, hence affecting the result of the experiment.



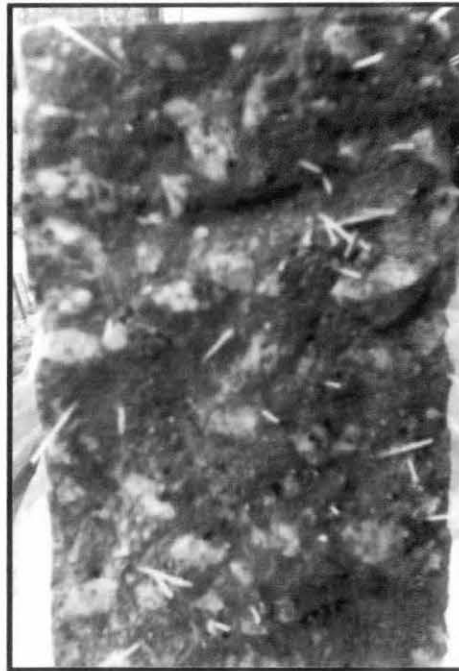
**Figure 5.10** : The coarse aggregate is concentrated at the outer side of sample.

In order to solve the problem, vibrating table as shown in **Figure 5.11** is used instead of vibrator.



**Figure 5.11** : Vibrating Table.

By using the vibrating table, the sample produced is shown in **Figure 5.12**.



**Figure 5.12** : The cross section of the sample using vibrating table

The distribution of aggregates and fiber inside the sample are significantly improved. However, there is still part inside the sample where the fiber is concentrated.

### 5.6 Slump Test

The addition of fiber inside the concrete reduces the slump of the fresh concrete. **Figure 5.13** shows the slump of concrete with 0% fiber and **Figure 5.14** shows the slump of concrete with 2% fiber.



**Figure 5.13** : Slump of concrete with 0% fiber

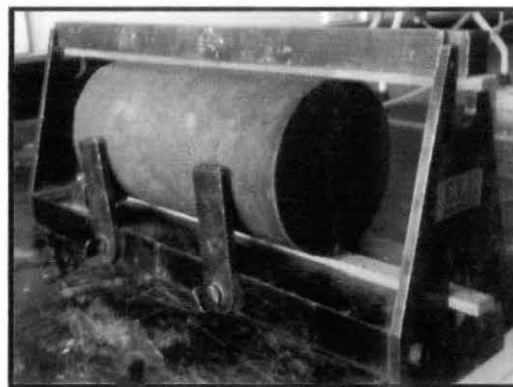


**Figure 5.14 :** Slump of concrete with 2% fiber

From the **Figure 5.13** and **Figure 5.14**, it can be concluded that the addition of fiber makes the fresh concrete becomes stiffer. By looking at the surface of both slumps, it looks wet for fresh concrete with 0% and dry for fresh concrete with 2%. The addition of 2% fiber into the fresh concrete is considered excessive since the slump is zero and there are many air voids inside the concrete.

### **5.7 Tensile Strength Testing**

For tensile testing of cylindrical concrete sample, the following holder as shown in **Figure 5.15** is used and 2 pieces of hardboards are placed between the holder and the sample (where the load is applied). The size of the hardboard is 4mm thick and 15mm wide as specified by BS 1881 : 117 : 1983.

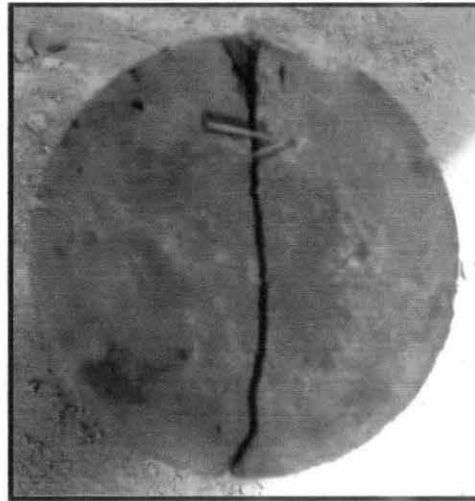


**Figure 5.15 :** Cylindrical sample holder for tensile test.



S. Nilsson (1961) states that the cube test, covered by BS 1881:Part 117:1983, gives the same result as the splitting test on a cylinder [21]. Since the cube holder for tensile test is not available in Concrete Laboratory of Universiti Teknologi Petronas, cylindrical tensile strength test is used instead of cubic tensile strength test.

The holder together with the sample is then put into the compression machine to apply the load. **Figure 5.16** shows the failure line at the surface of the sample.



**Figure 5.16** : Line of failure of tensile test.

From this figure, it can be concluded that the tensile test is succeeded since the line of failure is along the middle part of the sample.



## CHAPTER 6

### CONCLUSION

The optimum PVA fiber content that gives the highest tensile strength to the concrete is in the range of 1.0% to 1.5%. By adding 1.0% PVA fiber into the concrete, the tensile strength of concrete increased by approximately 27%. However, the tensile strength of the concrete can be further improved if the better fiber dispersion could be achieved during the sample preparation process.

In the sample preparation process, improved wet mixing process is the best mixing option compared to other mixing processes that have been used in this project. The fiber dispersion is better for this method of concrete mixing. For vibrating procedure, vibrating table should be used instead of hand vibrator to avoid disturbance of aggregates and fiber composition inside the concrete sample.

Scanning Electron Microscope (SEM) shows that there is no gap between the PVA fiber and the concrete. It proves the theory that the PVA fiber develops the molecular and chemical bonding with the cement. The test also shows that there is reaction takes place at the surface of the PVA fiber and this reaction could be caused by the cement or superplasticizer.



## REFERENCES

- [1] Eduardo Marcelo Bezerra 1,MSc., Ana Paula Joaquim 2, Dr., Holmer Savastano Jr.3, Prof. Dr. Some properties of fiber-cement composited with selected fibers, November 2004.
- [2] Bin Mua,\*, Zongjin Lib, Jun Pengb. Short fiber-reinforced cementitious extruded plates with high percentage of slag and different fibers, June 2000.
- [3] E.M. Bezerra a, A.P. Joaquim b, H. Savastano Jr. b,\*, V.M. John c, V. Agopyan c. The effect of different mineral additions and synthetic fiber contents on properties of cement based composites, February 2006.
- [4] Bengi Arisoy a,\*, Hwai-Chung Wu b. Material characteristics of high performance lightweight concrete reinforced with PVA, February 2006.
- [5] Shuxin Wang and Victor C. Li. Polyvinyl alcohol fibre reinforced engineered cementitious composites: Material Design and Performances, Universiti of Michigan, USA.
- [6] Thanasak Wongtanakitcharoen · Antoine E. Naaman. Unrestrained early age shrinkage of concrete with polypropylene, PVA, and carbon fibers, January 2005.
- [7] Victor C. Li, Shuxin wang, and Cynthia Wu. Tensile Strain-Hardening Behavior of Polyvinyl Alcohol Engineered Cementitious Composite (PVA-ECC), December 2001.
- [8] Josef P. Kaufmann · Frank Winnefeld · Daniela Hesselbarth · Walter Trindler. Evaluation of the consistency of fiber reinforced cementitious composites, June 2005.
- [9] Shin-ichi Torigoe, Tetsuo Horikoshi, Atsuhisa Ogawa, Tadashi Saito and Toshihiro Hamada. Study on Evaluation Method for PVA Fiber Distribution in Engineered Cementitious Composite, February 2003.





- [10] Tetsushi Kanda and Victor C. Li, Member, ASCE. Interface Property and Apparent Strength of High-Strength Hydrophilic Fiber in Cement Matrix, February 1998.
- [11] K.C.G. Ong \*, M. Basheerkhan, P. Paramasivam. Resistance of fiber concrete slabs to low velocity projectile impact, November 1998.
- [12] Y. Mohammadi, S.P. Singh, S.K. Kaushik. Properties of steel fibrous concrete containing mixed fibers in fresh and hardened state, September 2006.
- [13] A. M. Neville (2002). *Properties of Concrete*. Fourth edition. England, Pearson Education Limited.
- [14] Bantia N, Bentur A, Mufti A, editors. Fiber reinforced concrete: Present and future, Canadian Society for Civil Engineering, October 1998.
- [15] Chen WF, Carson JL. Stress-strain properties of random wire reinforced concrete. *ACI J* 1971;68(12):797-804.
- [16] Cengiz Duran Atis, Okan Karahan. Properties of steel fiber reinforced fly ash concrete, November 2007.
- [17] A. Sivakumar, Manu Santhanam. Mechanical properties of high strength concrete reinforced with metallic and non-metallic fibers, March 2007.
- [18] L.R. Betterman, C. Ouyang, and S.P. Shah. Fiber-Matrix Interaction in Microfiber-Reinforced Mortar, February 1994.
- [19] Edward G. Nawy. *Fundamentals of High Strength High Performance Concrete*, Longman Group Limited 1996.
- [20] Irving Kett. *Engineered Concrete : Mix Design and Test Methods*. CRC Press 1999.
- [21] S. Nilsson, The tensile strength of concrete determined by splitting tests on cubes, *RILEM Bull. No. 11*, pp. 62-7 (Paris, June 1961).



## APPENDICES

### APPENDIX A : Tables and graphs for concrete mix design

**Table 14.9** Approximate Compressive Strengths of Concretes Made with a Free Water/Cement Ratio of 0.5 According to the 1988 British Method<sup>10, 11</sup>

Type of cement cement	Type of coarse aggregate	Compressive strength* (MPa (psi)) at the age of (days):			
		3	7	28	91
Ordinary Portland (Type I)	Uncrushed	22 (3200)	30 (4400)	42 (6100)	49 (7100)
		Crushed	27 (3900)	36 (5200)	49 (7100)
Rapid-hardening Portland (Type III)	Uncrushed		29 (4200)	37 (5400)	48 (7000)
	Crushed	34 (4900)	43 (6200)	55 (8000)	61 (8900)

\*Measured on cubes.

Table I: Approximate compressive strength of concrete

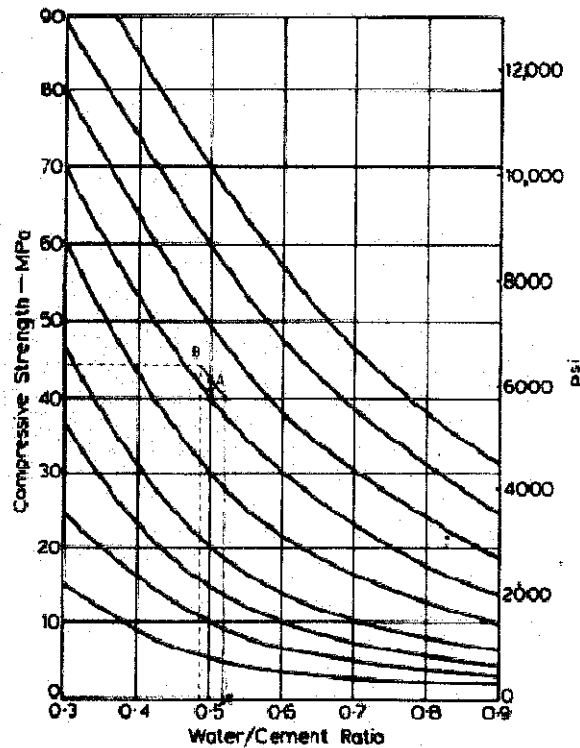


Figure I: Relation between compressive strength and free water/cement



**Table 14.10** Approximate Free Water Contents Required to Give Various Levels of Workability According to the 1988 British Method<sup>14 11</sup> (Crown copyright)

Aggregate		Water content, kg/m <sup>3</sup> (lb/yc <sup>3</sup> ) for:				
Max size, mm (in.)	Type	Slump, mm (in.)	0-10 (0- $\frac{1}{2}$ )	10-30 ( $\frac{1}{2}$ -1)	30-60 (1-2 $\frac{1}{2}$ )	60-180 (2 $\frac{1}{2}$ -7)
		Vegetime, s	> 12	6-12	3-6	0-3
10 ( $\frac{3}{8}$ )	Uncrushed		150 (255)	180 (305)	205 (345)	225 (380)
	Crushed		180 (305)	205 (345)	230 (390)	250 (420)
20 ( $\frac{3}{4}$ )	Uncrushed		135 (230)	160 (270)	180 (305)	195 (330)
	Crushed		170 (285)	190 (320)	210 (355)	225 (380)
40 (1 $\frac{1}{2}$ )	Uncrushed		115 (195)	140 (235)	160 (270)	175 (295)
	Crushed		155 (260)	175 (295)	190 (320)	205 (345)

Table II: Approximate free water contents required for various levels of workability

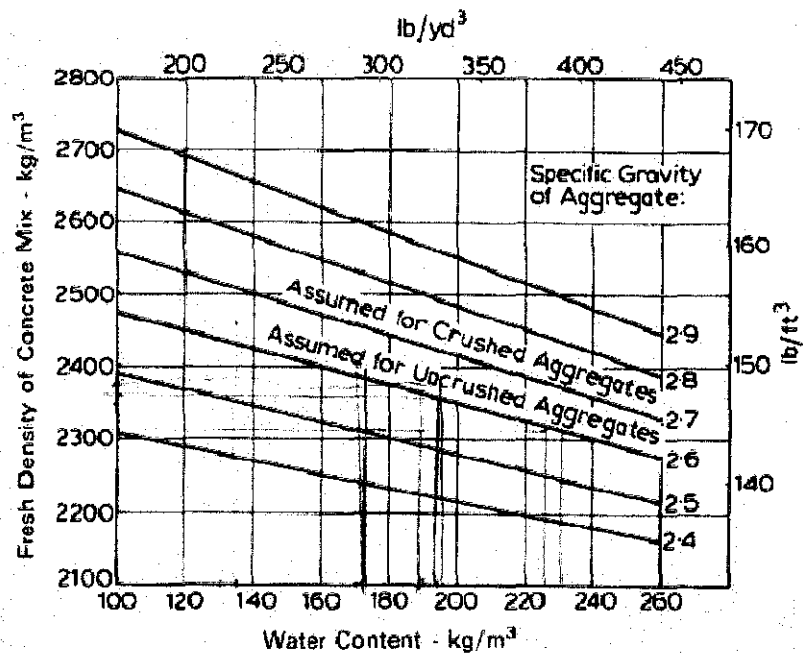


Figure II: Estimate wet density for fully compacted concrete

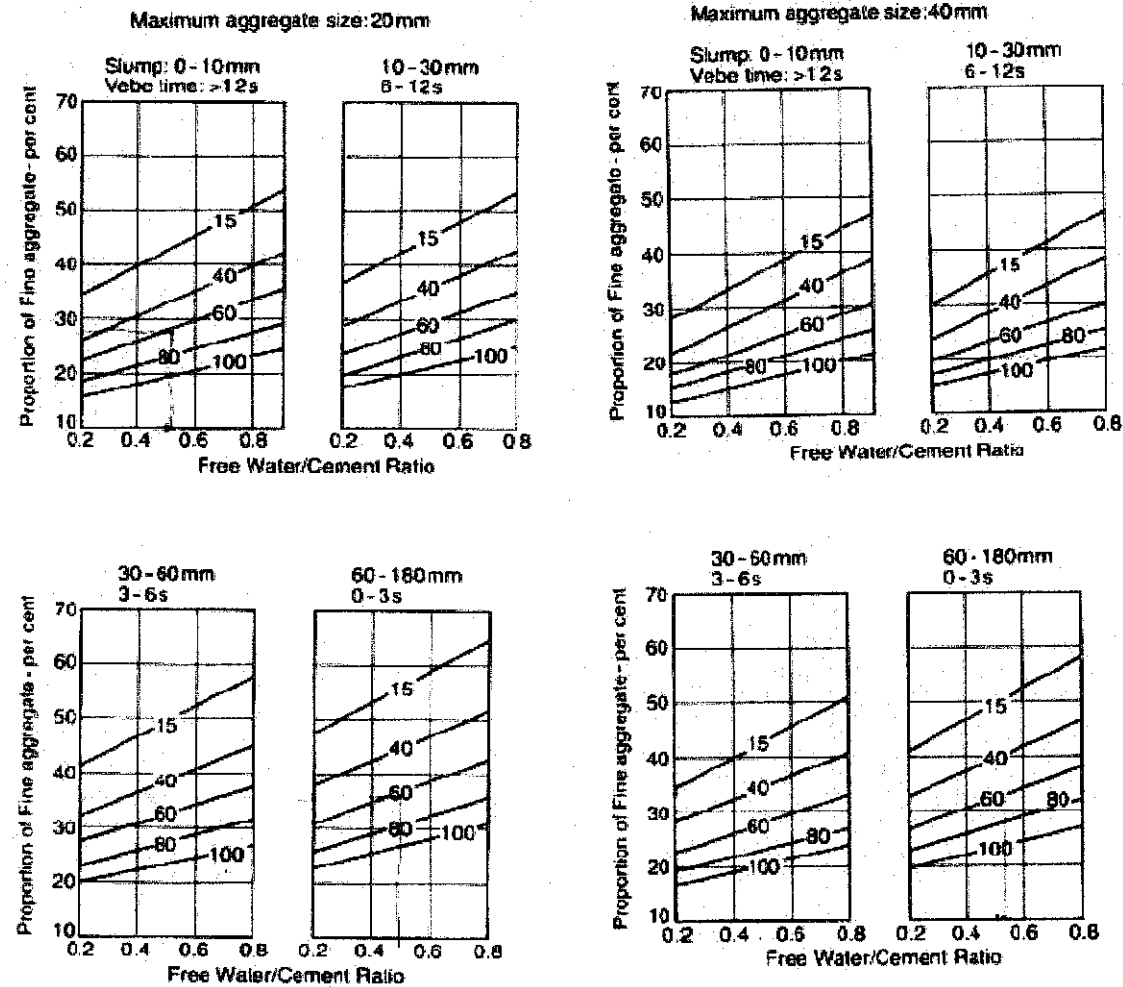
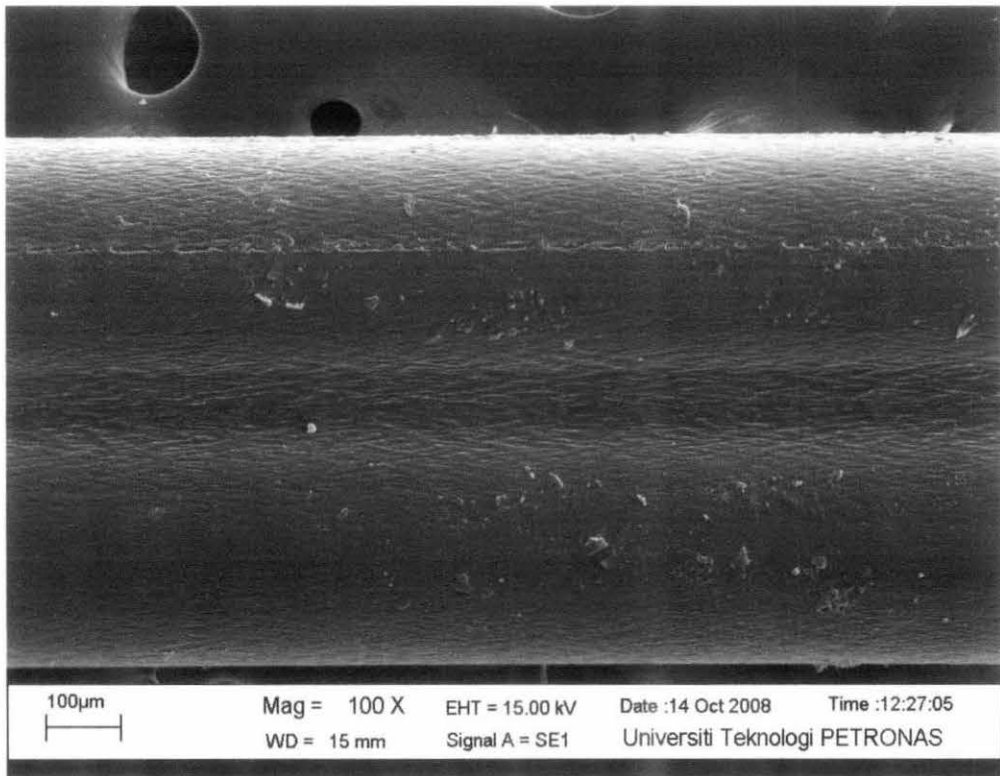
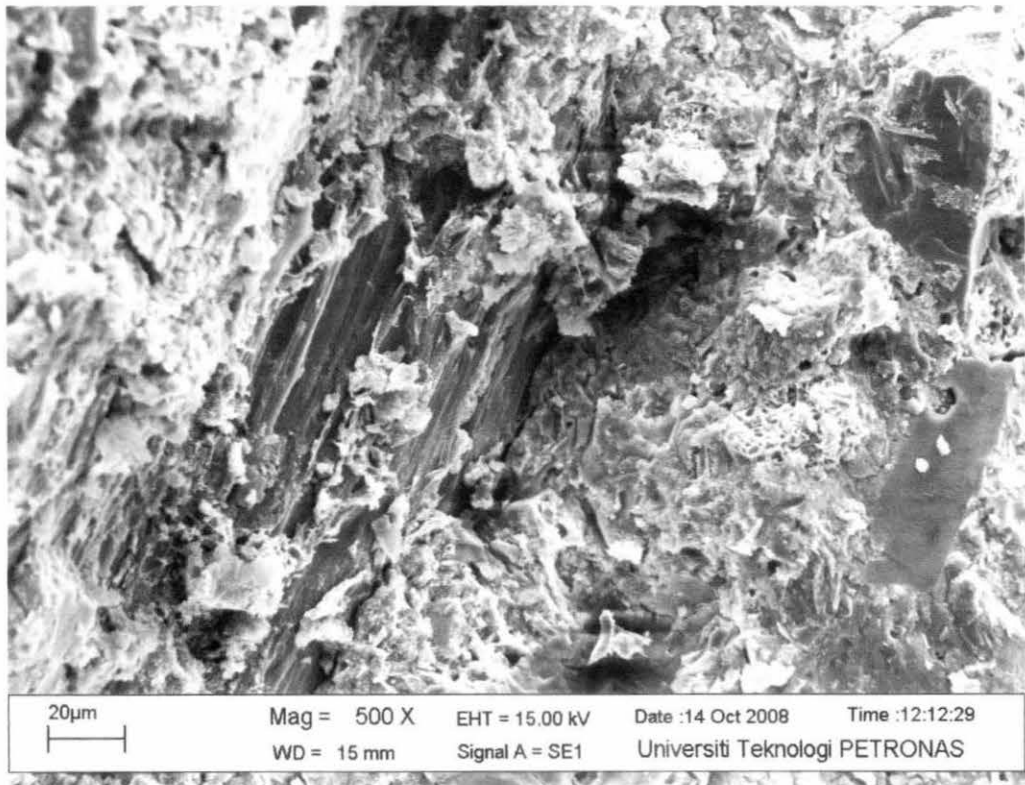
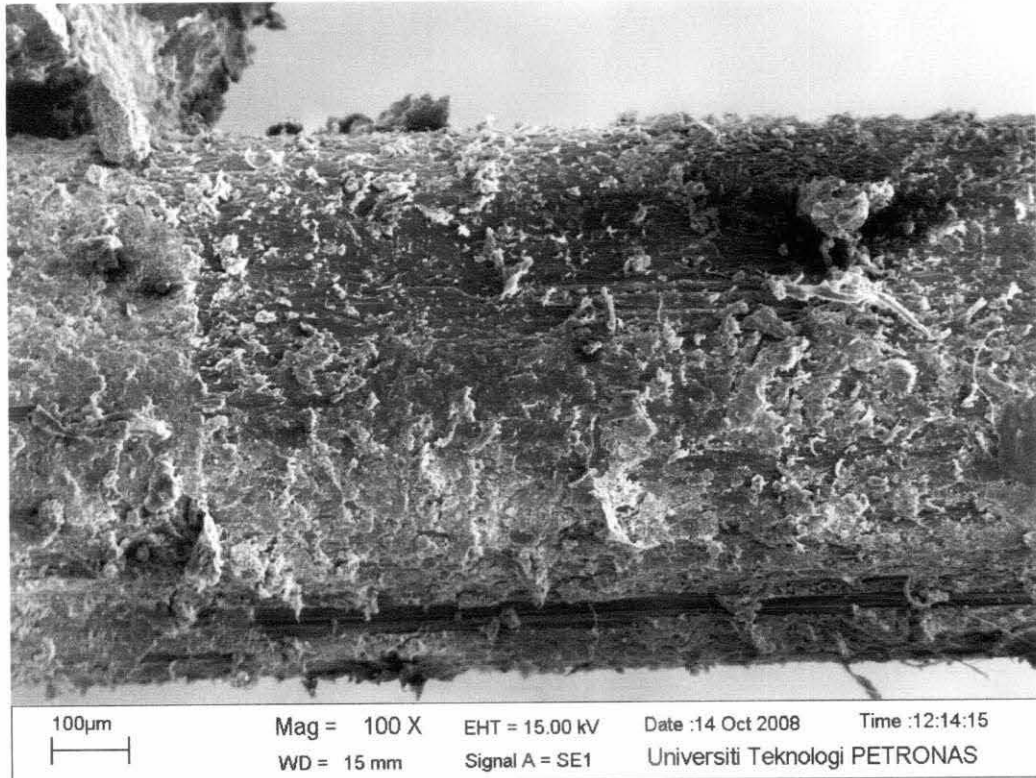


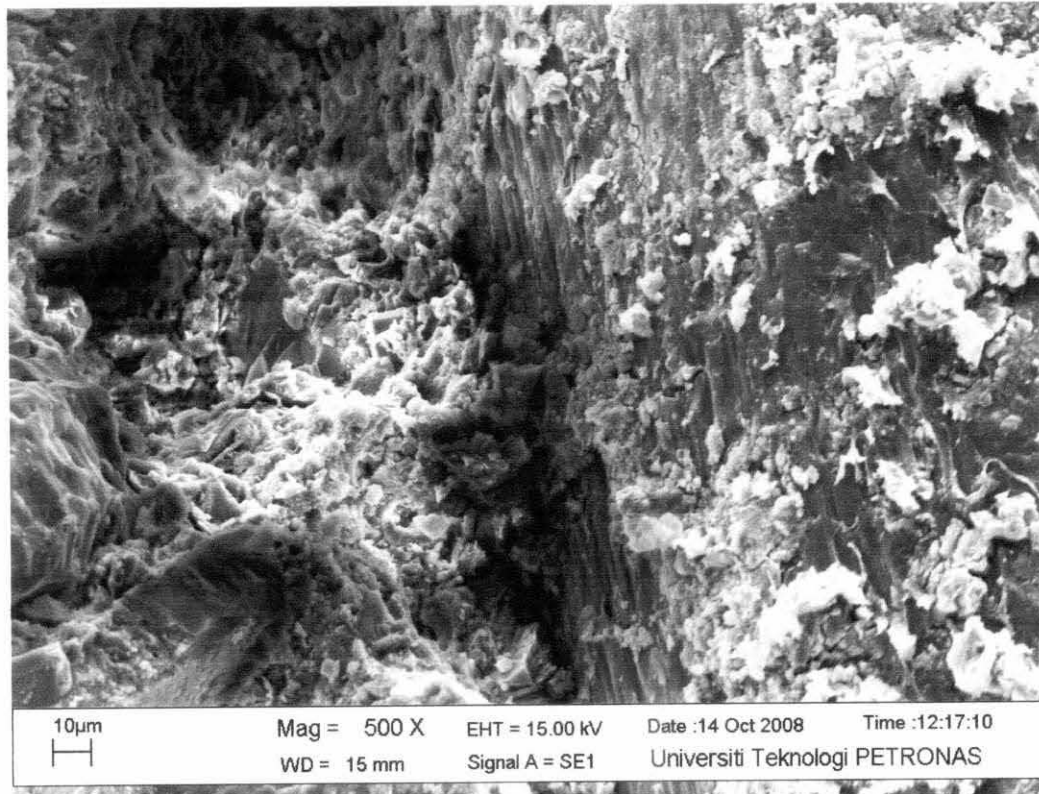
Figure III: Recommended proportion of fine aggregate as a function of free water/cement ratio for various workabilities and maximum sizes



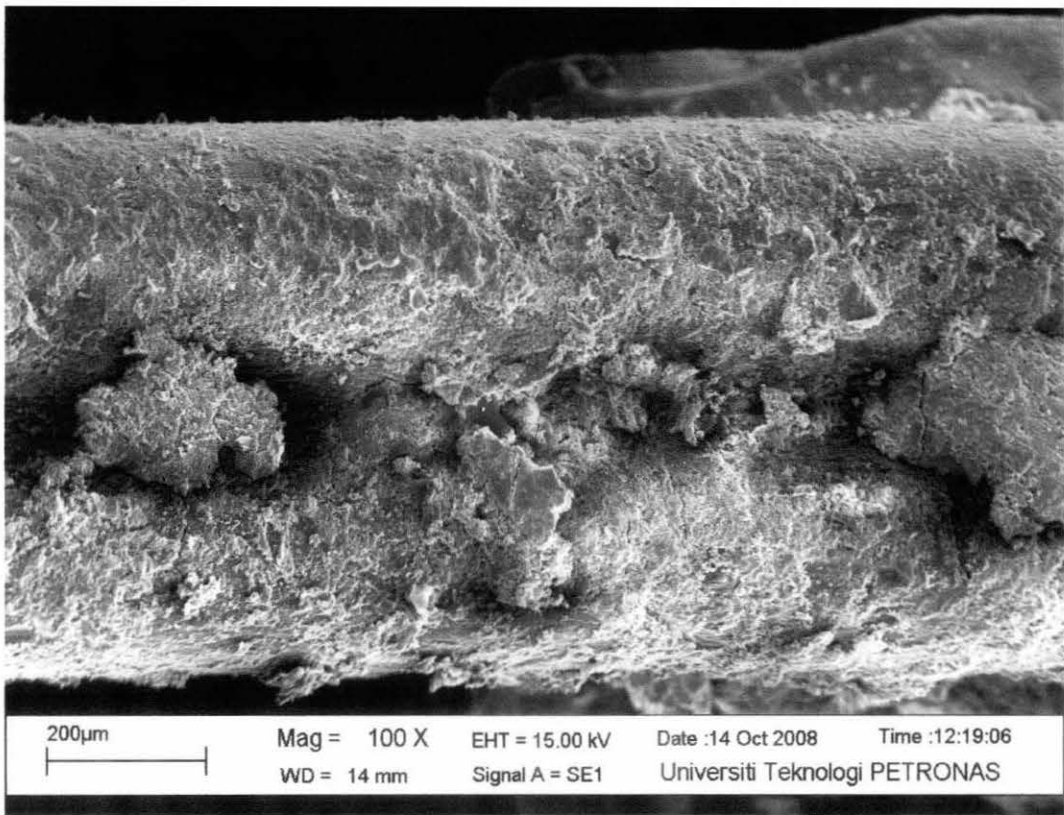
**APPENDIX B : Scanning Electron Microscope (SEM)****Figure IV** : Original PVA fiber surface**Figure V** : Bonding between PVA fiber and cement at 30<sup>th</sup> day



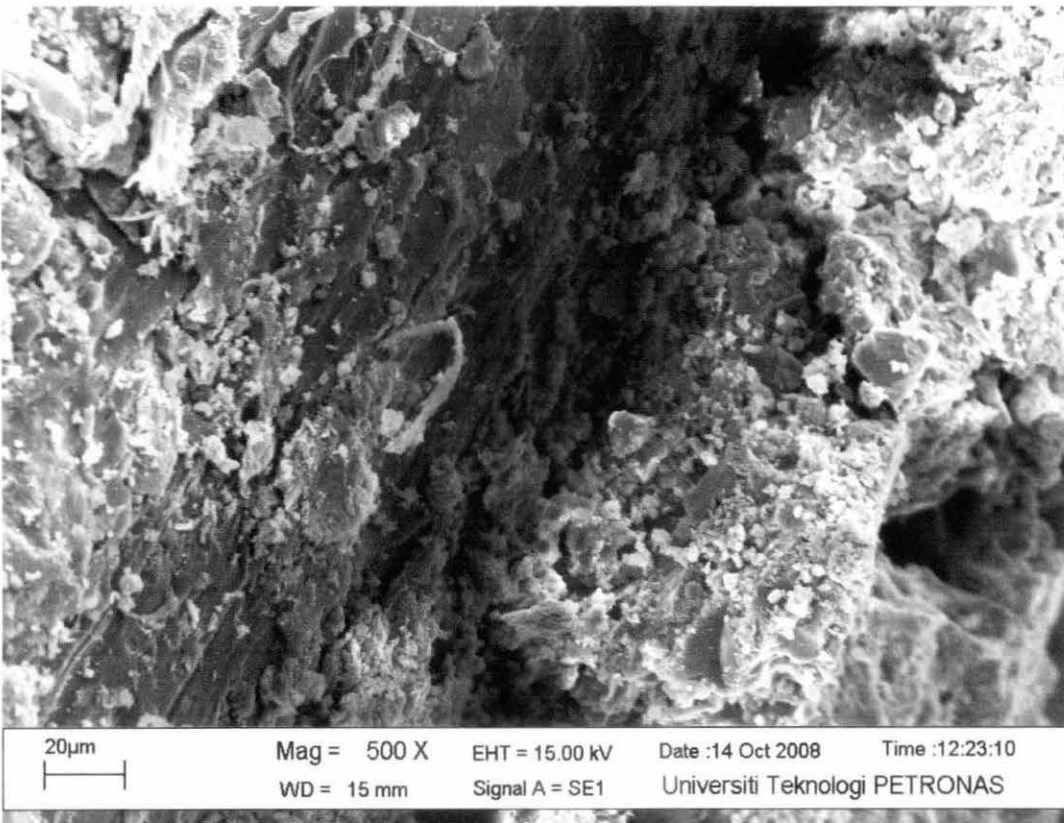
**Figure VI** : PVA fiber surface in concrete at 30<sup>th</sup> day



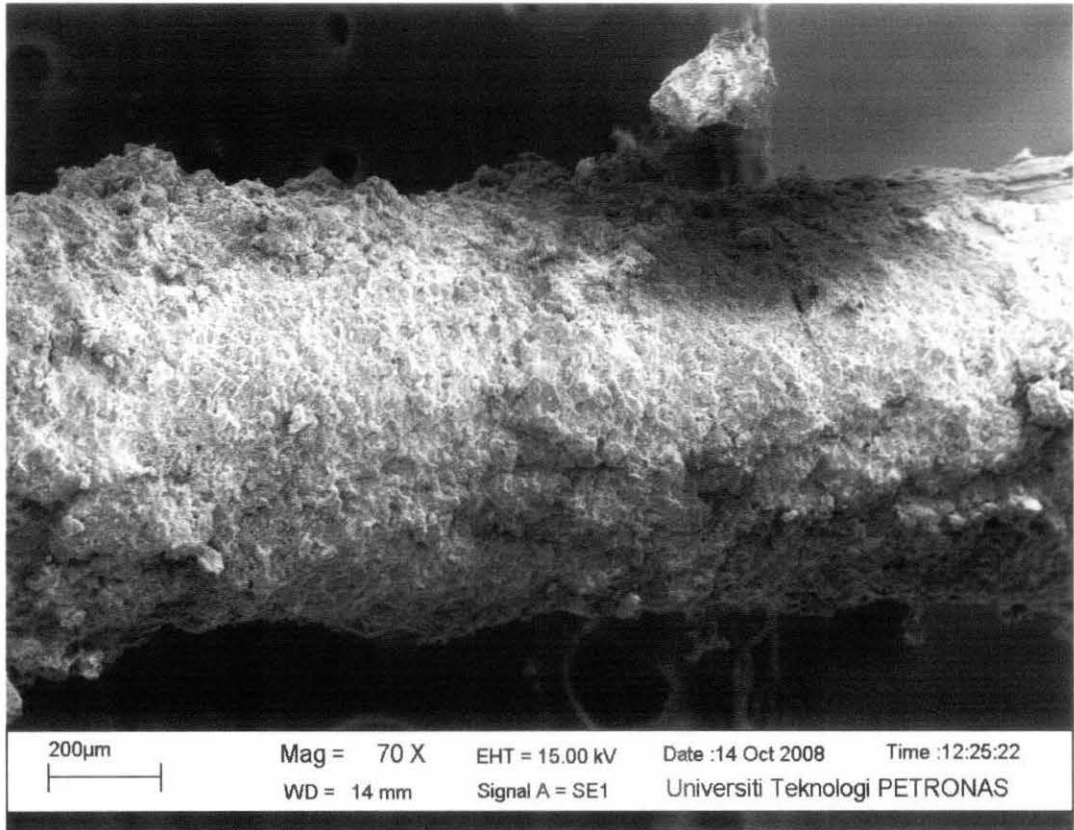
**Figure VII** : Bonding between PVA fiber and cement at 60<sup>th</sup> day



**Figure VII** : PVA fiber surface in concrete at 60<sup>th</sup> day



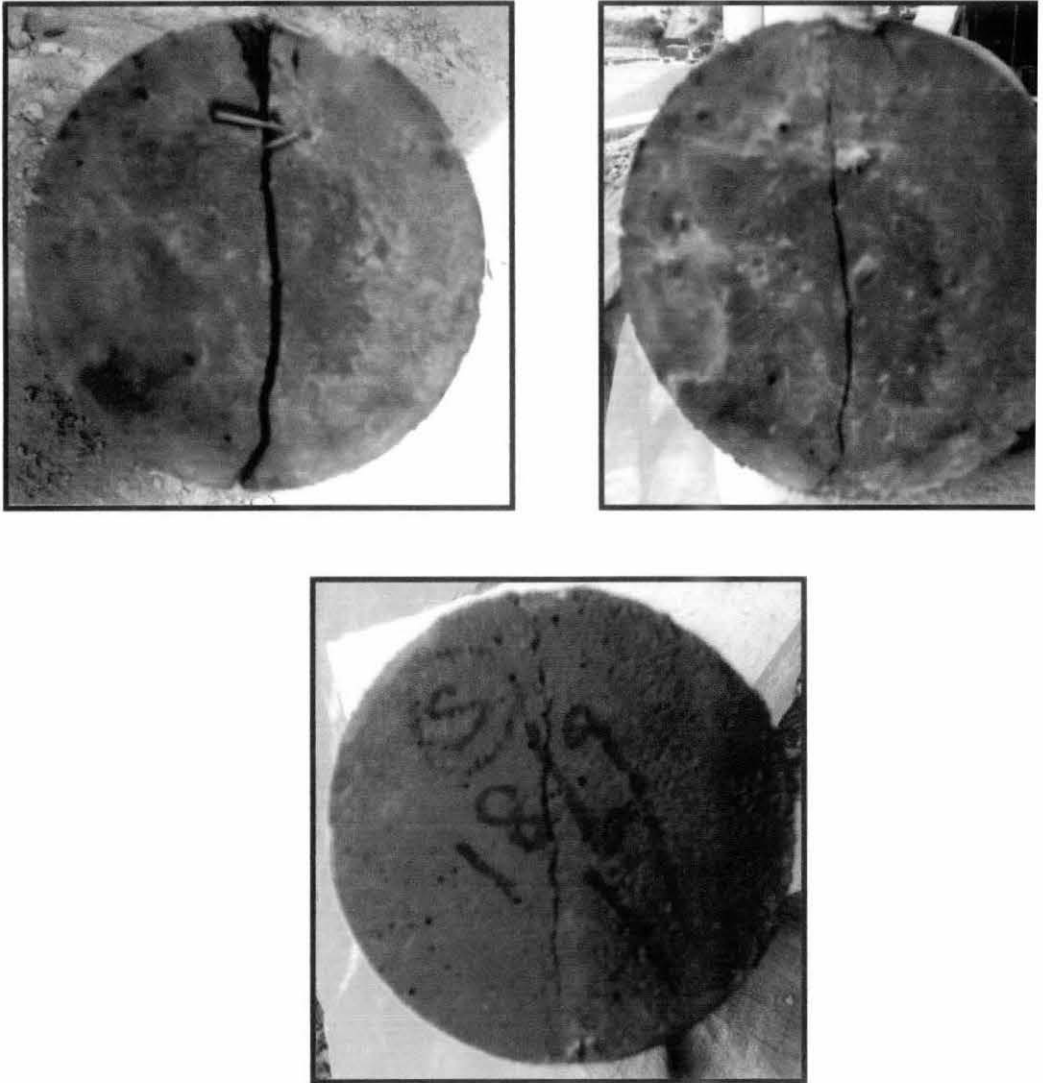
**Figure VIII** : Bonding between PVA fiber and cement at 90<sup>th</sup> day



**Figure IX** : PVA fiber surface in concrete at 90<sup>th</sup> day



**APPENDIX C : Line of failure for cylindrical tensile test (example)**

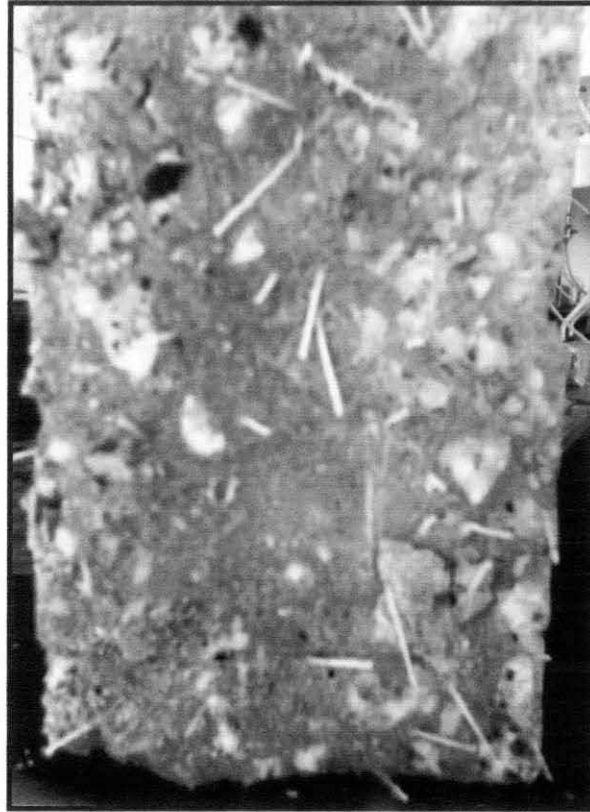


**Figure X** : Example line of failure after tensile test



## APPENDIX D : Cross section of sample (example)

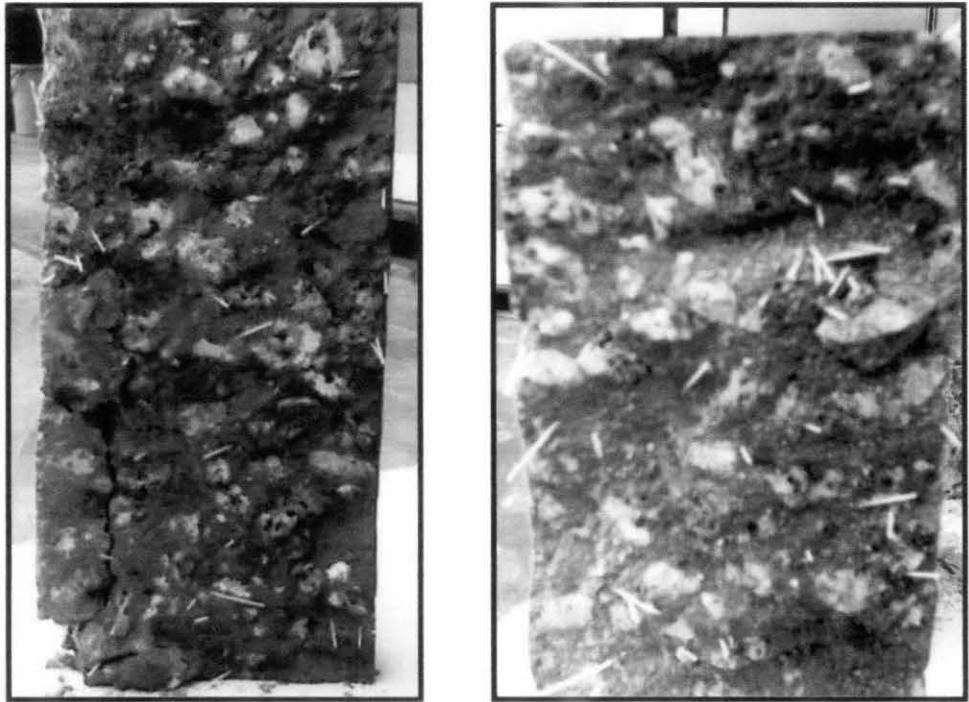
### A) Sample using hand vibrator



**Figure XI** : Example cross section of sample that made using hand vibrator (PVA fiber content 1.0%)



## B) Sample using vibrating table



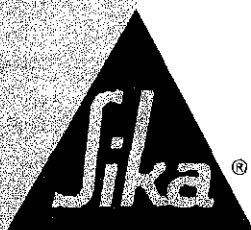
**Figure XII** : Example cross section of sample that made using vibrating table (PVA fiber content 1.0%)

# Sikament NN

## HWR - High Range Water Reducer

Construction

<b>Description</b>	A highly effective dual action liquid superplasticiser for the production of high slump concrete or as a substantial water reducing agent for promoting high early and ultimate strengths.
<b>Uses</b>	<p><b>Sikament NN</b> is used as a superplasticiser in the production of concrete such as:</p> <ul style="list-style-type: none"> <li>• Sprayed concrete</li> <li>• Slabs and foundations</li> <li>• Walls, columns and piers</li> <li>• Slender components with densely packed reinforcements</li> <li>• Textured surface finishes.</li> </ul>
<b>Advantages</b>	<p>It is also used as a water reducing agent leading to high early strengths in:</p> <ul style="list-style-type: none"> <li>• Prestressed concrete</li> <li>• Bridges and cantilever structures</li> </ul>
<b>Storage and Shelf life</b>	Stored at temperatures between 5°C and 35°C in unopened original containers protected from direct sunlight and from frost, shelf life is at least two (2) years.
<b>Application</b>	
<b>Dosage</b>	Depending on the workability required, <b>Sikament NN</b> is normally added at dose rates between 500 to 1500mls per 100kg of cement. Exact dosage rate should be determined by site trials.
<b>Mixing</b>	<p><b>Sikament NN</b> is best added directly to the freshly mixed concrete.</p> <p><b>Sikament NN</b> can also be added to the readymix truck on site. In this case, concrete should then be mixed for a further three minutes before placement.</p>
<b>Application Method</b>	Concrete mixed with <b>Sikament NN</b> is mixed on site in the precast yard, or is transported to site in readymix trucks. Concrete should be placed according to good concrete practices and proper curing procedures should take place.
<b>Specification Type</b>	<p><b>Sikament NN</b> meets and exceeds all requirements of Australian Standard 1478.1-2000 for High Range Water Reducing Admixture (HWR).</p> <p>Queensland Government Department of Main Roads approved.</p>



## Technical Data

Form	Agueous solution of sodium naphthalene formaldehyde sulphonate (SNS)
Colour	Brown
Density (20°C)	1.2kg/litre approx.
pH value (20°C)	7.0 ± 0.5
Chloride Content	No added chlorides
TEA Content	Does not contain triethanolamine
Air Entrainment	Slightly increased air content of concrete at normal dose rate
Packaging	20 litre pails 205 litre drums Bulk deliveries

## Important Notes

- Site trials should always be conducted to determine the optimum dosage rate of **Sikament NN** as a superplasticiser and a water reducer.
- **Sikament NN** can be combined with other Sika concrete admixtures, however site trials are recommended.

## Handling Precautions

- Avoid contact with the skin and eyes.
- Wear protective gloves and eye protection during work.
- If skin contact occurs, wash skin thoroughly.
- If in eyes, hold eyes open, flood with warm water and seek medical attention without delay.
- A full Material Safety Data Sheet is available from Sika on request.

## Important Notification

The information, and, in particular, the recommendations relating to the application and end-use of Sika's products, are given in good faith based on Sika's current knowledge and experience of the products when properly stored, handled and applied under normal conditions. In practice, the differences in materials, substrates and actual site conditions are such that no warranty in respect of merchantability or of fitness for a particular purpose, nor any liability arising out of any legal relationship whatsoever, can be inferred either from this information, or from any written recommendations, or from any other advice offered. The proprietary rights of third parties must be observed. All orders are accepted subject of our terms and conditions of sale. Users should always refer to the most recent issue of the Technical Data Sheet for the product concerned, copies of which will be supplied on request.

PLEASE CONSULT OUR TECHNICAL DEPARTMENT FOR FURTHER INFORMATION.



Sika Australia Pty Limited  
ABN 12 001 342 329

[www.sika.com.au](http://www.sika.com.au)

55 Elizabeth Street  
Wetherill Park NSW 2164  
Tel: (02) 9725 1145  
Fax: (02) 9725 2605

**Sikament NN**  
Page 2 of 2