

**On the Performance of Conventional Supercapacitor for Storage Devices in  
Solar Power Systems Application**

by

Haliza binti Zulkifli

Dissertation Report submitted in partial fulfillment of  
the requirements for the  
Bachelor of Engineering (Hons)  
(Electrical and Electronics Engineering)

SEPTEMBER 2011

Universiti Teknologi PETRONAS  
Bandar Seri Iskandar  
31750 Tronoh  
Perak Darul Ridzuan

© Copyright 2012 by HALIZA BINTI ZULKIFLI

CERTIFICATION OF APPROVAL

**On the Performance of Conventional Supercapacitor for Storage Devices in Solar  
Power Systems Application**

By

Haliza binti Zulkifli

A dissertation report submitted to the  
Electrical and Electronics Engineering Program  
Universiti Teknologi PETRONAS  
in partial fulfillment of the requirement for the  
BACHELOR OF ENGINEERING (Hons)  
(ELECTRICAL & ELECTRONICS ENGINEERING)

Approved by,

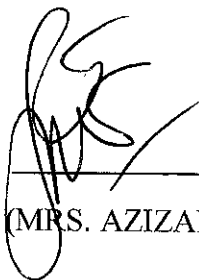

**AZIZAN ZAINAL ABIDIN**  
Senior Lecturer  
Fundamental & Applied Sciences Department  
Universiti Teknologi PETRONAS, PERAK.

(MRS. AZIZAN BINTI ZAINAL ABIDIN)

UNIVERSITI TEKNOLOGI PETRONAS

TRONOH, PERAK

September 2011

## CERTIFICATION OF ORIGINALITY

This is to certify that I am responsible for the work submitted in this project, that the original work is my own except as specified in the references and acknowledgements, and that the original work contained herein have not been undertaken or done by unspecified sources or persons.



---

(HALIZA BINTI ZULKIFLI, 10661)

## ABSTRACT

This report discusses the preliminary research conducted and basic explanation of the chosen topic, which is **“On the Performance of Conventional Supercapacitor for Storage Devices in Solar Power Systems Application”**. As technology advance with time, batteries still remain as one of the most important energy storage devices in the world. Batteries are widely used in electrical energy storage because it is the best energy storage devices available today. However, batteries have limitations that need to be improved such as high voltage drop, short life cycle, high discharge rate, high equivalent series resistance (ESR) and their adverse contribution to environmental issues. The objective of this project is to integrate supercapacitor (SC) in the design of equivalent circuit model that improve storing performance for stands alone solar power systems application by reducing the voltage drop of the battery. From the circuit model, the voltage drop of the battery and discharge rate of supercapacitor are the parameters to be investigated. The circuit model identification is done by conducting experiments in the laboratory to collect all possible data. The equivalent circuit of solar supercapacitor (SSC) is expected to flatter the voltage drop by the extended discharging time thus improving storage capacity of the battery. Study and research claimed that due to a large value of capacitance, the supercapacitor can be used as energy storage device in renewable energy source application for which the project concern on solar power systems.

## ACKNOWLEDGEMENTS

The author would like to express her deepest gratitude to the all mighty God for His guidance and blessing throughout the completion this report.

For most of the appreciation, the author would like to address to Ms. Azizan Zainal Abidin, the project supervisor, for her willingness to share the idea with the author. For her time spent and understanding of the nature. For flexibility of work she offered. Not to mentioned, her effort in supervising, mentoring and delivering many precious lessons to the author on both technical and non-technical matters. Thank you.

To Ms. Azelin Mohamed Noor, for giving a clear guidance on writing format for the project and share valuable knowledge and experience, a lot of thank you. Not to forget, the UTP staffs, technician in Electrical and Electronics Department, especially Ms. Siti Hawa, for giving assistance, supporting and guidance within these 5 years and making it seems to be too short to spend here.

The appreciation would be incomplete without acknowledging of the university, for every possibilities and chances they provided. In addition to that, the author would like to thank her supportive family members and the love one for their unyielding support, understanding, love and encouragement every single day, even though the project really took a lot of time away from them.

Last but not least, to those who are involved in the completion of this Final Year Project whether directly or indirectly, a lot of thank you.

## TABLE OF CONTENTS

DISSERTATION REPORT .....	Error! Bookmark not defined.
CERTIFICATION OF APPROVAL .....	3
CERTIFICATION OF ORIGINALITY .....	4
ABSTRACT .....	5
ACKNOWLEDGEMENTS .....	6
TABLE OF CONTENTS .....	7
LIST OF FIGURES .....	10
LIST OF TABLES .....	11
LIST OF ABBREVIATIONS .....	12
CHAPTER 1 .....	13
INTRODUCTION .....	13
1.1 Background of Study .....	13
1.2 Problem Statement .....	15
1.2.1 Voltage drop of the battery .....	15
1.2.2 Discharging Rate of the battery .....	15
1.3 Objective .....	16
CHAPTER 2 .....	18
LITERATURE REVIEW .....	18
CHAPTER 3 .....	30
METHODOLOGY .....	30
3.1 Procedure Identification .....	30
3.1.1 Part 1 .....	30
3.1.2 Part 2 .....	31
3.2 Tools and Equipments Used .....	32
3.2.1 Hardware .....	32

3.2.2	<i>Software</i> .....	34
3.3	<b>Design Approach</b> .....	35
3.3.1	<b>Experiments using PSPICE</b> .....	35
3.3.1.1	<i>Solar battery stand alone charging</i> .....	35
3.3.1.2	<i>Battery/ 1SC in parallel combination</i> .....	37
3.3.1.3	<i>Battery/ 2SCs in parallel combination</i> .....	38
3.3.1.4	<i>Battery/ 3SCs in parallel combination</i> .....	39
CHAPTER 4	.....	40
RESULT AND DISCUSSION	.....	40
4.1	<b>Results</b> .....	40
4.1.1	<i>The voltage drop</i> .....	40
4.1.1.1	<i>The voltage drop across the solar charging battery</i> .....	40
4.1.1.2	<i>The voltage drop across the battery/1 SC combination</i> .....	40
4.1.1.3	<i>The voltage drop across the battery/2 SCs combination</i> .....	40
4.1.1.4	<i>The voltage drop across the battery/3 SCs combination</i> .....	40
4.1.2	<i>The discharging rate of the supercapacitor</i> .....	41
4.1.2.1	<i>The output current waveform for Section 3.3.1.2</i> .....	43
4.1.2.2	<i>The output current waveform for Section 3.3.1.2</i> .....	43
4.1.2.3	<i>The output current waveform for Section 3.3.1.3</i> .....	44
4.1.2.4	<i>The output current waveform for Section 3.3.1.4</i> .....	44
4.1.3	<i>Calculation for power efficiency</i> .....	45
4.2	<b>Discussion</b> .....	46
4.2.1	<i>Supercapacitor reduce the voltage drop of the battery</i> .....	46
4.2.2	<i>Analysis of the discharging rate of the supercapacitor</i> .....	48
4.2.3	<i>Analysis of the output current for the equivalent circuit</i> .....	49
4.2.4	<i>Analysis for power efficiency for combination of battery and supercapacitor...</i>	49
CHAPTER 5	.....	51
CONCLUSION AND RECOMMENDATION	.....	51

<b>5.1</b>	<b>Conclusion.....</b>	<b>51</b>
<b>5.2</b>	<b>Limitations .....</b>	<b>52</b>
<b>5.3</b>	<b>Recommendations.....</b>	<b>53</b>
	<b>REFERENCE .....</b>	<b>54</b>



## LIST OF FIGURES

<b>Figure 1: Block Diagram of stands alone solar PV [10] .....</b>	<b>19</b>
<b>Figure 2: Monocrystalline solar panel [13] .....</b>	<b>21</b>
<b>Figure 3: Cross-sectional of alkaline battery .....</b>	<b>22</b>
<b>Figure 4: Cross-sectional of lead-acid battery [2].....</b>	<b>23</b>
<b>Figure 5: Cross-sectional of SC .....</b>	<b>24</b>
<b>Figure 6: Photovoltaic stand-alone systems [21].....</b>	<b>27</b>
<b>Figure 7: Flow chart of the project .....</b>	<b>30</b>
<b>Figure 8: Flow chart to generate circuit model.....</b>	<b>31</b>
<b>Figure 9: Charging battery using solar cell 3V.....</b>	<b>35</b>
<b>Figure 10: Solar battery charging.....</b>	<b>36</b>
<b>Figure 11: 1 SC combined with battery.....</b>	<b>37</b>
<b>Figure 12: 2 SCs combined in parallel with battery.....</b>	<b>38</b>
<b>Figure 13: 3 SCs combined in parallel with battery.....</b>	<b>39</b>
<b>Figure 14: Investigating the discharge time of SC.....</b>	<b>41</b>
<b>Figure 15: Output current through load.....</b>	<b>43</b>
<b>Figure 16: Output current waveform through 1 SC.....</b>	<b>43</b>
<b>Figure 17: Output current waveform through 2 SCs.....</b>	<b>44</b>
<b>Figure 18: Output current waveform through 3 SCs.....</b>	<b>44</b>
<b>Figure 19: Discharging rate of supercapacitor for different circuit orientation....</b>	<b>48</b>
<b>Figure 20: Current waveform through battery/1SC.....</b>	<b>63</b>
<b>Figure 21: Current waveform through battery/ 2 SCs.....</b>	<b>63</b>
<b>Figure 22: Current waveform through battery/ 3 SCs.....</b>	<b>63</b>

## LIST OF TABLES

<b>Table 1: Comparison of the performance between battery, capacitor and supercapacitor [15] .....</b>	<b>26</b>
<b>Table 2: Device and Equipments used for the project.....</b>	<b>32</b>
<b>Table 3: List of software used for the project.....</b>	<b>34</b>
<b>Table 4: The discharging time of SC right after the switch is opened .....</b>	<b>42</b>
<b>Table 5: Total voltage drop for each circuit orientation .....</b>	<b>47</b>
<b>Table 6: Output current for each circuit orientation .....</b>	<b>49</b>

## LIST OF ABBREVIATIONS

AC	Alternating Current
Ah	Ampere-hours
C	Capacitance of the supercapacitor (Farad)
Ceq	Equivalent capacitor
D	Duty cycle
DC	Direct Current
ESR	Equivalent Series Resistance
E <sub>max</sub>	Maximum energy storage
I	Magnitude Current of the Current (Ampere)
LED	Light Emitting Diode
PV	Photovoltaic
R	Resistance of the Resistor (ohm)
SC	Supercapacitor
SSC	Solar Supercapacitor
V <sub>c</sub>	Voltage across supercapacitor
V <sub>eq</sub>	Equivalent voltage
$\eta$	Efficiency of the System (Percentage)
$\Delta t$	Battery Current Run-Time of the System (minutes)
U	Switch

## CHAPTER 1

### INTRODUCTION

This section will explain the elements deliberated in the background of study for the project. The background of study contains general description and the history of the related topic. The objectives of the project describe the purpose of this project is being carried out while the scope of study gathers the information related for the design of the prototype and simulation process.

#### 1.1 Background of Study

In 1745, the capacitor was a liquid-filled glass jar with a layer of foil wrapped around the exterior. It began as a laboratory curiosity, but with improvement of technology it developed into an important laboratory instrument. Now, in twentieth century, the capacitor becomes a main component in electrical circuits. The function of the capacitor is to store electric charge. It is used with resistors in timing circuits because it takes time for a capacitor to be filled with charge. The capacitor is also used to smooth varying DC supplies by acting as a reservoir of charge. It is also used in filter circuits because capacitors easily pass AC changing signals but they block DC constant signals [1].

The battery was invented over 200 years ago by Alessandro Volta (1754-1827), a Professor of Natural Philosophy at the University of Pavia in Italy. The first battery known as Volta' pile was invented in 1800. It's design based on the combination of a pile of silver with zinc discs [2]. Since then, the battery has becomes a conventional power

source which stores energy and have the specific voltage drop based on its capacity. The voltage drop of the battery is defined as the voltage drop across one or more connections and components [3]. Typically, people increase the circuit conductor in order to maintain the current between the positive and negative points. This method will reduce the voltage drop of the battery [3].

However, batteries contribute to environmental issues such as mercury pollution which is found in the electrolyte of batteries. If human are exposed to mercury, they may become paralyzed and crippled. It can also lead to death [4]. Other than that, battery is affected by surrounding temperature changes. The high and low temperature reduces its performance, thus contributing to inaccurate initial voltage of the battery. In colder temperatures, battery produces low output voltage but as the temperature increases, the output voltage gets higher and stays longer [5]. Battery requires high maintenance to maintain and sustain their life span. The life span of battery reduces when one uses them continuously.

The nanotechnology of capacitor has become more advanced with the creation of the supercapacitor or ultracapacitor. The supercapacitor (SC) is built in with thinner charge-separation distance. Technically, it is known as the electrochemical double-layer capacitors. The supercapacitor has low equivalent series resistance (ESR) compared to the battery which allows it to absorb, distribute high current with low voltage drop. It also has a greater energy density and power per pound as compared to the electrostatic and the electrolytic capacitor [6].

## **1.2 Problem Statement**

Batteries are widely used as the common energy storage in the household and industries especially as a battery bank for solar power systems. However, there are several weaknesses of batteries which need to be improved for a better storing capacity for solar application. The two weaknesses that are emphasized to be improved in this project are the voltage drop of the battery and discharging rate of the battery.

### ***1.2.1 Voltage drop of the battery***

In stand-alone solar power systems, battery has a large voltage drop. The voltage drop of the battery is defined as the electrical energy passes along a wire and it is affected by internal resistance of the battery [3]. Typically, people combined multiple batteries together in order to increase the storage capacity of the battery. This method will increase the voltage drop of the battery thus reducing the energy storing efficiency [7].

### ***1.2.2 Discharging Rate of the battery***

During charge and discharging of the battery, the terminal voltage decreases as the charge reduces. The flatter the voltage drop, the better the performance [3][7]. To get the flat voltage drop, the battery should have a reasonably flat discharge curve until they are nearly exhausted because of the current drawn from the battery. This discharge curve affects the performance of the battery as the storage devices in solar power systems application.

### **1.3 Objective**

The objective of this project is to integrate supercapacitor (SC) in the design of equivalent circuit model that improve storing performance for stands alone solar power systems application by reducing the voltage drop of the battery.

### **1.4 Scope of Study**

This study focuses on designing supercapacitor (SC) circuit performance. All possible equivalent circuit models are designed in the laboratory to choose the best circuit model. This study will involve analytical calculations of electrical parameters to support the working prototype.

Overall, the project scope can be divided into two stages whereby the first stage is the study of the theories behind the solar supercapacitor (SSC) application. The second stage is to simulate the feasible equivalent circuit design using PSPICE, generate the graph using MATLAB and Data Studio Software with the combination of Science Workshop 750 Interface. The simulation is expected to calculate the voltage drop and the discharging time of supercapacitor. Capacitance of supercapacitor is going to be affecting the downstream experiments.

### **1.5 Relevancy of the Project**

The purpose of this study is to perform experiment on the characteristic of conventional supercapacitor in term of some particular parameter. In this project, the focused parameters are voltage drop of the battery and the discharge rate of the supercapacitor. The result of experiment will show the performance in comparison batteries alone as storage device and batteries combined with SC. This study can be used to improve the storing capacity of the battery for solar power systems application.

## 1.6 Feasibility of the Project

The final year project is divided into two parts. Part 1, named as FYP 1 taken in MAY 2011 semester should be the stage where all the information is gathered. The experiment should be well planned with the right procedure. Thus the result in the experiment will be used for the next stage, Part 2, named as FYP 2 taken in SEPTEMBER 2011 semester. The second stage is to perform the task planned in FYP 1 and constructing prototype. Block diagram below illustrates the scope covered in FYP 1 and FYP 2.

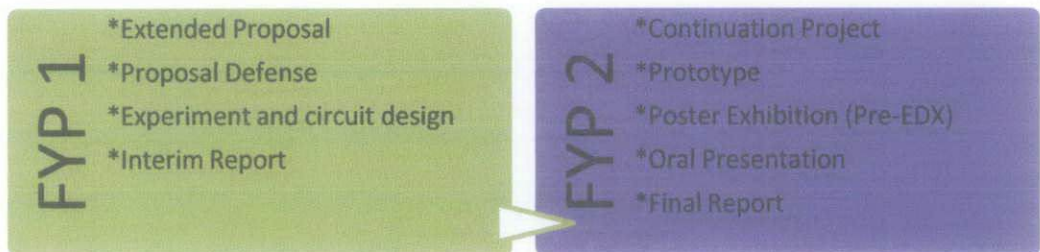



## CHAPTER 2

### LITERATURE REVIEW

Research and survey showed that there is no exact device or system in the market that shared the similar objective with this current project. However some of the devices in the market share useful information in order to understand the nature of the supercapacitor (SC) as a storage device for solar power systems. From the research and survey, five elements can be extracted. They are:

#### **2.1 Stand-alone Solar Power Systems**

Solar power is a clean energy source with great potential. Its development through technological advances in panel design and materials make solar power more functional and practical. In Malaysia, solar panel is usually used for water heating purposes in hotels, the lighting purposes in building, and upper-class urban homes for the water heater and backup power systems [8]. At present, solar photovoltaic (PV) applications in Malaysia are restricted to rural electrification, street and garden lighting, and telecommunications. Malaysia built its first centralized solar power station in 2003 in a remote tropical village of Kampung Denai on the eastern coast [8]. Yet many seem to think that solar power is expensive, not easily constructed and the lack of awareness among Malaysian in this green technology [8]. Fast depleting non-renewable energy source and rising greenhouse emissions have led to a race among nations to drive the agenda of renewable energy. Ocean energy, wind energy and solar energy are some examples. This project will however focus on solar energy.

Solar energy is the radiant light and heat from the sun. The energy from sun released is  $3.8 \times 10^{23}$  kW. The solar energy received by earth and atmosphere are  $1.7 \times 10^{14}$  kW. This energy is captured in the device called solar panels otherwise called PV cell, which convert the light energy into electricity [9].

A stand-alone solar power system is not connected to the grid. It is also called as off-grid solar power systems. **Figure 1** shows the block diagram of stand-alone solar PV. These systems are installed in remote areas where there is no utility-supplied power and it is portable. This solar energy system is often cheaper to install than lay electricity cables to the site. Excess energy can be stored in a battery for use during times where there is no sunshine [10]. In this project, the stands-alone model will be used. The battery bank is the storage device to accumulate the solar energy. Further explanation for battery is discussed in Section 2.3.

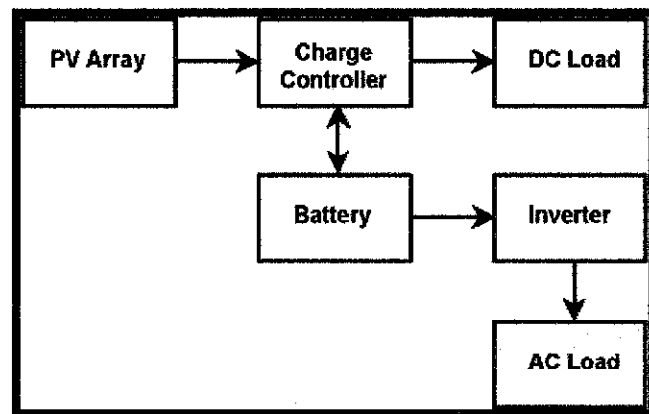

**Figure 1: Block Diagram of stands alone solar PV [10]**

## 2.2 Solar Panel

Solar panel is the part that catches the sunshine and converts it to electricity. The process is the stream of electrons produces the DC current and the electrons moving along a wire or conductor. To make electrons move in one direction, the solar panel is coated with silicon layers. Doped silicon allows electrons to travel through it, in only one direction and will not allow electrons to go back the other way. When electrons are under the sun, they absorb energy and becoming excited, and begin to move in all directions [11]. Because electrons are trapped in the silicon, they get stopped in one direction, and move freely in the other direction. Once the electrons are moving, all in the same direction, the electricity is produced. The nominal output voltage of a solar panel is usually 12 Volts and can be used single or wired together into an array. The number and size required is determined by the available light and the amount of energy required [11].

In this project, the solar panel used is monocrystalline type. Monocrystalline cells are cut from a silicon ingot grown from a single large crystal of silicon and these solar panels are efficient commercially [12]. The advantages of monocrystalline solar panels are due to its ready availability. It is made from just one crystal, not multiple crystals fused together. More wattage per square foot can be delivered with these panels. The average 175 watt panel is about sixty-three inches in length, thirty one inches in width, a little over an inch high, and weighs thirty-three pounds, with an aluminum frame. The lifespan of a monocrystalline cell is a minimum of twenty-five years and can be more than fifty [12]. However, like other types of solar panels, monocrystalline solar modules suffer a reduction in output once the temperature from the sunlight reaches around fifty degrees Celsius (50°C). Reductions of between twelve and

fifteen percent of temperature are to be expected. **Figure 2** shows the features describing the module [13].

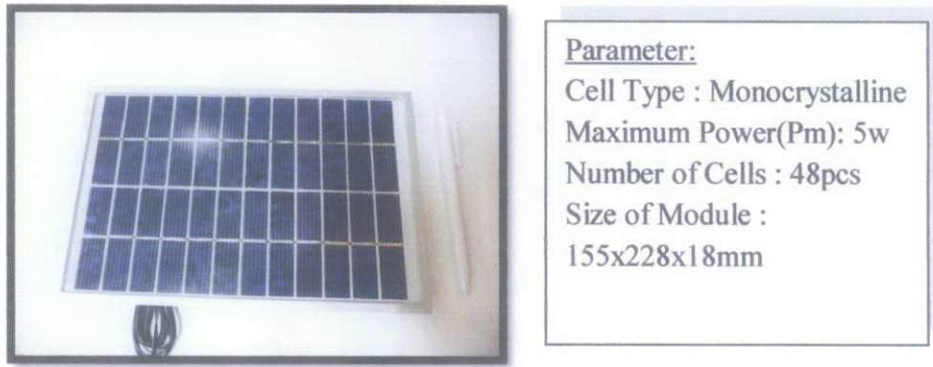

**Figure 2: Monocrystalline solar panel [13]**

### 2.3 Battery

The battery stores energy electrochemically which converts the chemical energy into the electrical energy. The capacity of the battery depends on the charge and discharge rates as well as the surrounding temperatures. Battery is divided into two groups; primary and secondary batteries. Primary battery can be used only once, and then they will be thrown away whilst the secondary batteries can be used after being recharged. Battery designs come in a wide range of sizes such as AA battery, AAA battery, 4.5-volt and 9-volt battery for primary type and for secondary type are lead acid battery which is lithium-ion (LI-ion) battery and nickel cadmium (NiCd) battery [2].

The alkaline battery is commonly used as the power supply for the electrical appliances such as mini radio, flashlight and alarm clock. The alkaline battery is enclosed in a nickel-plate steel that is also called as positive cathode contact. This nickel plate steel is separated from the negative anode contact at the

bottom side of batteries by a cardboard insulator or separator as shown in **Figure 3**. This alkaline battery contains the powdered graphite and manganese dioxide which is separate by a fabric separator to the powdered zinc. Then a tin-plated brass anode collector is used to conduct the current from anode to the cardboard insulator. The plastic plug is used to hold the fabric separator and the tin-plated brass anode collector to make sure that these two parts maintain in the right position. Generally, the alkaline battery has 1.5V cell storage and two years of shell life [7].

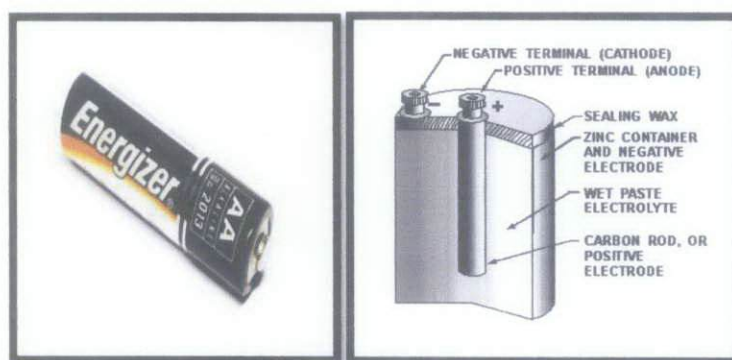
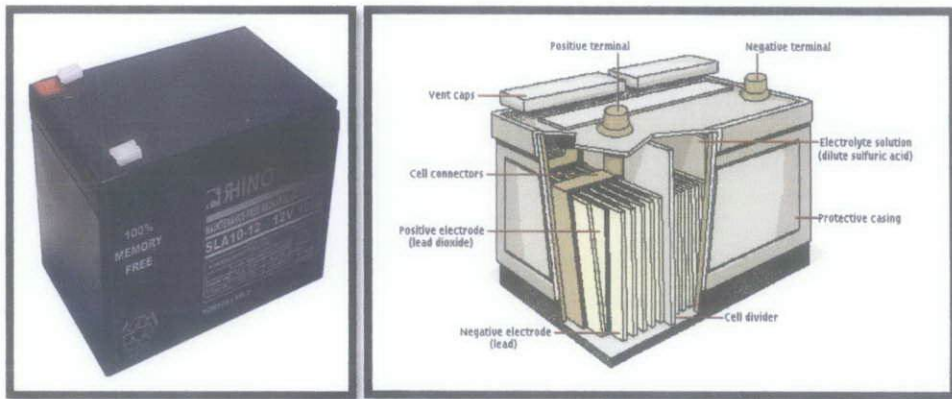

**Figure 3: Cross-sectional of alkaline battery**

The lead acid battery is an electrical storage device that uses a reversible chemical reaction to store energy. It uses a combination of lead plates and an electrolyte consisting of a diluted sulphuric acid to convert electrical energy into potential chemical energy and back again. It can produce 12.6V (fully charged) and consists of six cells connected in series inside molded polypropylene case. The electrolytes of lead acid battery consist of 65% of water and 35% of sulfuric acid. The electrolyte of lead acid battery is hazardous to health and may produce burns and other permanent damage if people come into contact with it. Thus, batteries contribute to environmental issues such as mercury pollution which is found in the electrolyte of batteries. If human are exposed to mercury, they may become paralyzed and crippled. It can also lead to death [4]. Several precautions should be taken while dealing with electrolyte.

Lead acid battery is commonly used as the power source of vehicles.

**Figure 4** below shows the cross-sectional of lead acid battery.



**Figure 4: Cross-sectional of lead-acid battery [2]**

Batteries capacity is determined by the amount of electrical energy the battery can deliver over a certain period of time and is measured in Ampere hours (Ah) when discharged at a uniform rate over a given period of time. Ampere hours (Ah) are calculated by multiplying the current (in amperes) by time (in hours) the current is drawn. The amp-hour battery rating is commonly used on sealed lead acid batteries in solar power systems [7]. Whilst the charge/discharge rate is determined by the amount of time it takes to fully discharge the batteries [7].

Battery poses several advantages such as high energy density and low initial cost but the disadvantages of the batteries are lower power density, low cycle life, high equivalent series resistance (ESR) and inability to supplying efficient pulsating load [5]. Although batteries are the most popular energy storage device for electrical appliances such as mobile phones, laptop computers, and other battery-powered devices because of its portability and cost efficiency, it gives rise to environmental issues such as toxic metal pollution, soil pollution and groundwater pollution. Without proper disposal method of batteries, some

dangerous elements such as lead, mercury and cadmium may enter the environment easily [4]. The high ambient temperatures are affected by batteries. The high and low voltage reduces its performance, thus contributing to inaccurate initial voltage of the battery. Each year, battery loses about eight to twenty percent of their original charge at a temperature of 20°C to 30°C. In this case, the lifetime of battery reduce due to exposures to high temperatures [5]. Battery has a shorter lifetime if there is no maintenance, and it needs to be replaced frequently. People have to spend for new battery due to the malfunction of the old battery. In other word, the lifetime of battery is dependent upon their continual usage and maintenance [4][5].

## 2.4 Supercapacitor

The structure of a supercapacitor also called electric double layer capacitors or ultracapacitor includes two electrodes, separated by a porous insulator and impregnated with an organic electrolyte [14]. **Figure 5** shows the cross-sectional of supercapacitor.

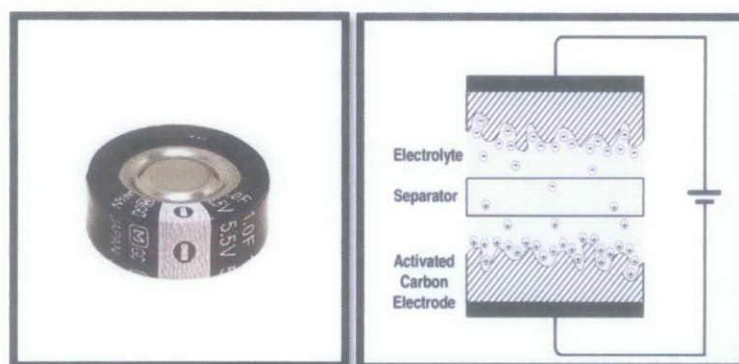

**Figure 5: Cross-sectional of SC**

The electrode is made of an aluminum current collector foil, supporting the activated carbon powder. The electrode inner surface is not smooth because it is padded with activated carbon. This characteristic contributes to greater surface area which is about 100 000 times as large as the surface area of conventional capacitor [15].

The supercapacitor operating principle is based on the double layer at the interface between the activated carbon electrode and the organic electrolyte when a voltage is applied to the terminals. The capacitance for supercapacitor may lie in the range of 1–5000 F. The maximum voltage typically up to 3 V is limited by the decomposition voltage of the electrolyte, mainly because of the presence of impurities. Because of these characteristics, supercapacitor is also classified as an energy storage device [15] [16].

Research about energy storage devices developed by Drexel University shows that they may improve the longevity of battery-powered device. Due to the battery environmental issues, researches have been done to develop supercapacitor as a new storage technology [17]. However, the study is yet still in progress.

Supercapacitor store energy through reversible ion adsorption at high surface area electrodes usually made of carbon, in contrast with batteries, which store electrical energy in the chemical bonds of bulk materials. This difference allows supercapacitor to charge and discharge faster, recharge up to a near infinite number of times, and operate at a wider temperature range with high efficiency [18][19]. Supercapacitor is built of environmentally friendly materials, such as carbon, aluminum and polymers. The supercapacitor has low equivalent series resistance (ESR) which allows it to absorb and distribute high current. It also has greater energy density and power per pound as compared to electrostatic and electrolytic capacitor [6]. Other characteristics of supercapacitor are; unlimited



life cycle, rapidly charging property with simple charging method, cost effective energy storage, and offers high capacitance in a small size. These characteristics qualify the supercapacitor as the efficient and reliable replacement of battery.

Table 1 presents a comparison between the characteristics of a battery, capacitor, and supercapacitor. It is clear that supercapacitor has several advantages compared to other elements.

**Table 1: Comparison of the performance between battery, capacitor and supercapacitor [15]**

Storage devices characteristics	Battery	Capacitor	Supercapacitor
<b>Charging time</b>	$1 < t < 5 \text{ h}$	1–30 s	$10^{-3} < t < 10^{-6}$
<b>Discharging time</b>	$t > 0.3 \text{ h}$	1–30 s	$10^{-3} < t < 10^{-6}$
<b>Energy density (W h/kg)</b>	10–100	1–10	<0.1
<b>Lifetime (cycle number)</b>	1000	$10^6$	$10^6$
<b>Power density (W/kg)</b>	<1000	10,000	>1,000,000
<b>Charge/discharge efficiency</b>	0.7–0.85	0.85–0.98	>0.95

## 2.5 Solar supercapacitor Application (SSC)

The amount of power generated by solar cells is determined by the amount of light striking on the solar panel. This is in turn, dependent on weather and time of day. In the stands-alone systems, some form of energy storage will be necessary. This type of systems used the lead-acid battery as battery bank. The

number and type of batteries depends on the amount of energy storage needed. However, the battery will be damaged if it is allowed to be overcharged or over discharged. Thus, the charge controller is needed to protect the battery bank [20]. Refer **Figure 6** for the block diagram consists of charge controller.

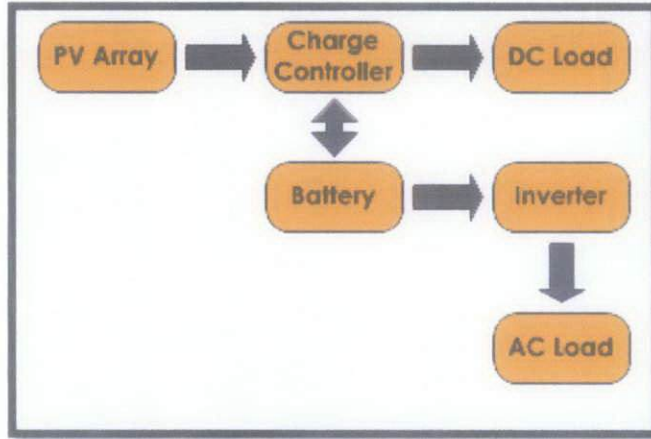

**Figure 6: Photovoltaic stand-alone systems [21]**

For this project, the main focus is to reduce the voltage drop of the battery and improve the discharge rate of the battery for SSC. The derivation of some parameter is described as below [21] [22];

First of all, the voltage across a supercapacitor,  $V_c$  is given by;

$$V_c = QC \quad \dots(1)$$

Where  $Q$  = charge stored in supercapacitor

$C$  = capacitance of supercapacitor

The energy stored,  $E$  is given by the expression (2);

$$E = 1/2 CV_c^2 \quad \dots(2)$$

The maximum energy stored in supercapacitor depends on its equivalent capacitance,  $C_{eq}$ . The expression for maximum energy storage can be represented as:

$$E_{\max} = \frac{1}{2} ( C_{\text{eq}} \times V_{\max}^2 ) \quad \dots(3)$$

Where  $E_{\max}$  = maximum energy storage capacity

$C_{\text{eq}}$  = equivalent capacitance of SC bank (in Farad)

$V_{\max}$  = maximum voltage of supercapacitor bank

The rating voltage and the value of the capacitance when the supercapacitor connected in parallel to each other are determined by using equation (4) and (5).

$$V_{\text{eq}} = V_1 = V_2 = V_3 \quad \dots(4)$$

$$C_{\text{eq}} = C_1 + C_2 + \dots C_n \quad \dots(5)$$

The rating voltage and the value of the capacitance when the supercapacitor connected in series to each other are determined by using equation (6) and (7).

$$V_{\text{eq}} = V_1 + V_2 + \dots V_n \quad \dots(6)$$

$$C_{\text{eq}} = 1/ C_1 + 1/C_2 + \dots 1/C_n \quad \dots(7)$$

Total voltage drop for battery stand-alone,  $V_d = I * IR \quad \dots(8)$

Where  $V_d$  = Total voltage drop

$I$  = peak pulse current

$IR$  = internal resistance

Total voltage drop for battery with SC,  $V_d = (I * ESR) + (\Delta t * I/C) \quad \dots(9)$

Where  $V_d$  = Total voltage drop

$I$  = peak pulse current

$ESR$  = equivalent series resistance

$\Delta t$  = time pulse width

$C$  = capacitance (in Farad)

The discharging time of supercapacitor is investigated by using the different value of the capacitance of the supercapacitor. Average discharging time of the supercapacitor is:

$$T_{\text{average}} = (t_1 + t_2 + t_3 + \dots + t_n) / n \quad \dots(10)$$

The internal losses of the combination circuit are given by equation (11):

$$P_{\text{loss,source(c)}} = R_1 I_{\text{source,rms}}^2 + R_2 I_{\text{SC,rms}}^2 \quad \dots(11)$$

The losses in the conventional circuit without the supercapacitor can be calculated based on the equation (12):

$$P_{\text{loss,source}} = R_1 I_{\text{load}} (\sqrt{D}) \quad \dots(12)$$

Where  $D$  = duty cycle, the proportion of time during supercapacitor is operated.

The power loss reduction is given by the equation (13):

$$\Delta P = P_{\text{loss,source}} - P_{\text{loss,source(c)}} \quad \dots(13)$$

The normalized power loss defined as the ratio of the power loss reduction to the power loss in the circuit without the ultra-capacitor. Thus the normalized power can be calculated by using the equation (14):

$$\Delta P_n = \frac{\Delta P}{P_{\text{loss,source}}} \quad \dots(14)$$

The output power of load given by equation (15):

$$P_{\text{out}} = V_{\text{load}} I_{\text{load}} (\sqrt{D}) \quad \dots(15)$$

The efficiency of the system is defined as the total output power ( $P_{\text{out}}$ ) produced in the system to the input ( $P_{\text{in}}$ )

$$\eta = \frac{P_{\text{out}}}{P_{\text{in}}} \times 100\% \quad \dots(16)$$

CHAPTER 3  
METHODOLOGY

**3.1 Procedure Identification**

**3.1.1 Part 1**

The flow chart in **Figure 7** shows the steps taken to finish the project.

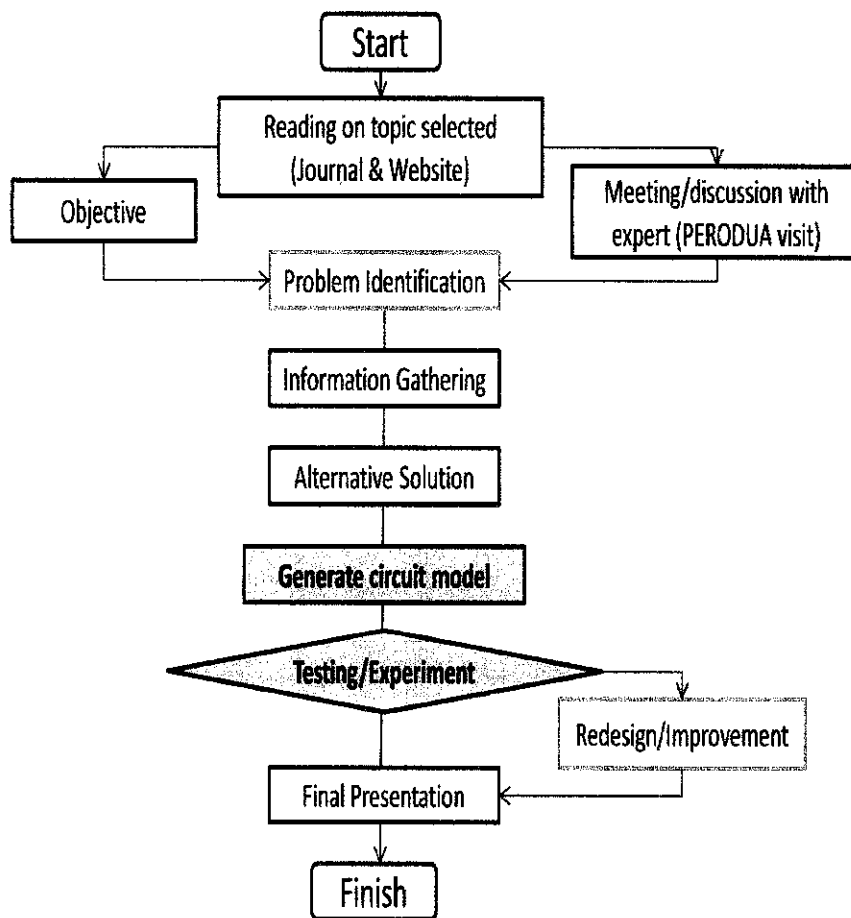

**Figure 7: Flow chart of the project**

### 3.1.2 Part 2

The flow chart in **Figure 8** shows the steps to generate the feasible circuit model for the experiment.

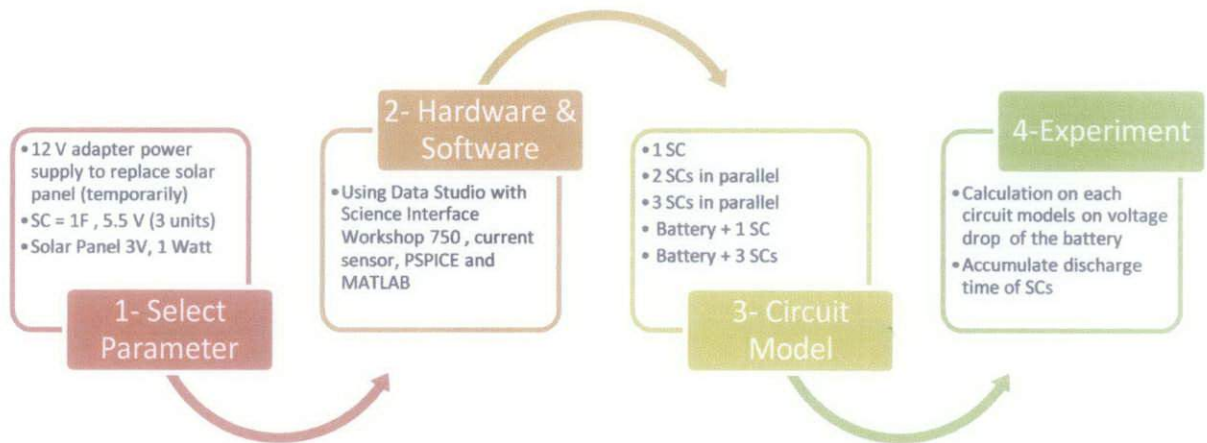

**Figure 8: Flow chart to generate circuit model**





## 3.2 Tools and Equipments Used

### 3.2.1 Hardware

**Table 2** below show the equipments used to design the feasible equivalent circuit of the battery with supercapacitor combination.

**Table 2: Device and Equipments used for the project**

No	Device / Equipment	Figure
1	Solar Panel or PV array	
2	Resistor , 100Ω	
3	Supercapacitor, 1F	
4	Light Emitting Diode (LED)	
5	1N5817 Diode	



6	Battery	
7	Current Sensor	
8	DMM	
9	Science Workshop 750 Interface	



### 3.2.2 Software

Table 3 below show the list of software used to design the feasible equivalent circuit of the battery with supercapacitor combination.

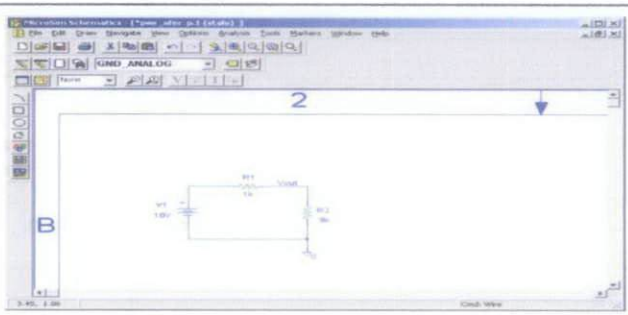
**Table 3: List of software used for the project**

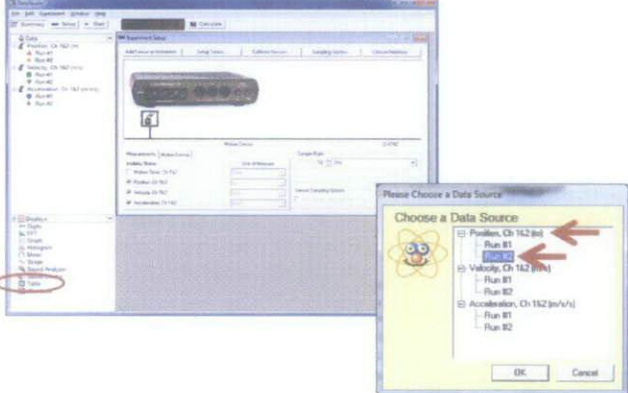
No	Software
1	<p>PSPICE</p>  <p>The screenshot shows the PSPICE software interface. The main window displays a circuit diagram with a 1.5V DC voltage source on the left, connected to a network of resistors and capacitors. A large number '2' is overlaid on the diagram. The software's menu bar and toolbar are visible at the top.</p>
2	<p>MATLAB</p>  <p>The screenshot shows the MATLAB 7.5.0 (R2007b) software interface. The Command Window is open, displaying a prompt '&gt;&gt;'. The current directory is set to 'C:\Documents and Settings\Administrator\My Documents'. The software's menu bar and toolbar are visible at the top.</p>
3	<p>Data Studio</p>  <p>The screenshot shows the Data Studio software interface. A 'Choose a Data Source' dialog box is open, listing several data sources: Position, Ch 112 (m), Run B1, Run B2, Velocity, Ch 112 (m/s), Run B1, Run B2, Acceleration, Ch 112 (m/s^2), Run B1, and Run B2. Red arrows point to the 'Run B1' and 'Run B2' entries under each category. The 'Data' folder in the left-hand tree view is circled in red.</p>

### 3.3 Design Approach

#### 3.3.1 Experiments using PSPICE

Experiments are done in many stages. The first stage is to study the solar battery charging. The next stage, the circuit will be combined with supercapacitor in parallel to reduce the voltage drop of the battery. From this, the discharge rate of the supercapacitor is measured and the current waveform through the supercapacitor is captured using current sensor with Data Studio.

##### 3.3.1.1 Solar battery stand alone charging

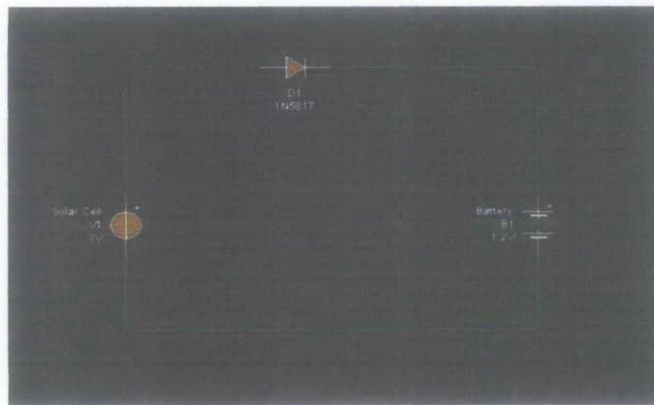
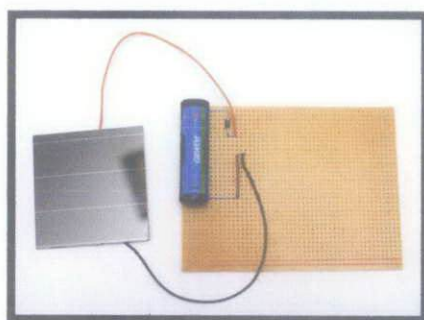

**Figure 9: Charging battery using solar cell 3V**

From **Figure 9**, the LED is 3.2 – 3.6 V forward voltages and it must be placed in the circuit the correct way around. The 1N5817 Diode is used to allow current to flow in only one direction. This is to prevent the battery power discharging through the solar panel during no light conditions. It will drop about 0.2V from the systems. This blocking diode needs placing in the circuit in the correct orientation like LED [23]. The diode has a circular band across its barrel at one end of the diode. This should be

grounded or closest to the negative. While the solar PV, the maximum output is 3V at 150 mA. The solar cells positive is connected through the diode to the positive terminal of the 1.2V battery.

In previous experiment, there was an error while not practicing this step as precaution. The supercapacitors have burnt because of the excessive current across the circuit. For the safe condition, use higher value of resistor, 100Ω [24]. If the voltage of the solar cell drops below 1.4V then with the 0.2V the blocking diodes takes, there will be not enough potential to charge the 1.2V battery. The purpose of the diode is to forbid current dissipating out from the battery to the solar cell whenever this low voltage condition occurs in the solar cell. **Figure 10** shows the circuit orientation of the experiment. The battery will soon be combined with supercapacitor in the next stages.



**Figure 10: Solar battery charging**

$$\begin{aligned} \text{Total voltage drop, } V_d &= I * IR \quad \dots(8) \\ &= 0.016A * 0.525 \Omega \\ &= 8.4 \text{ mV} \end{aligned}$$

### 3.3.1.2 Battery/ ISC in parallel combination

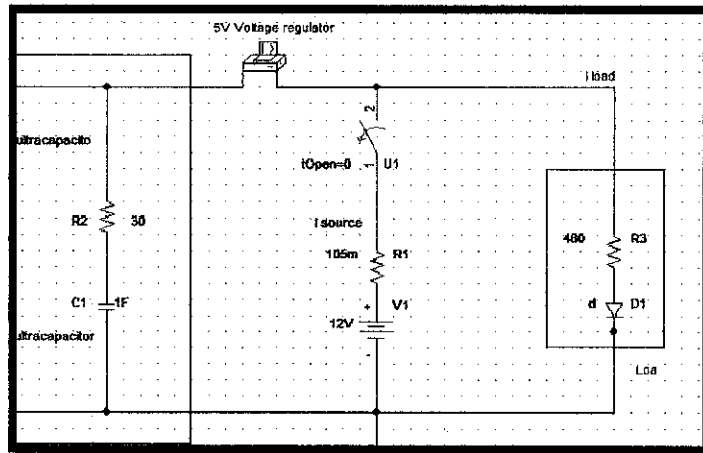
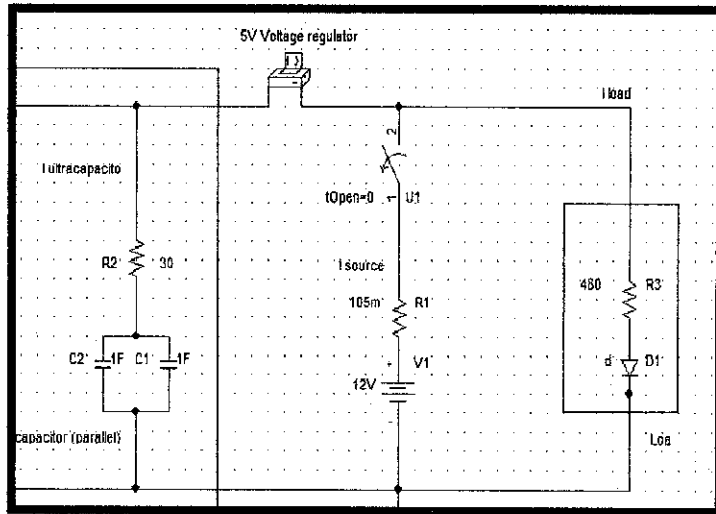

Figure 11: 1 SC combined with battery

Figure 11 show that the circuit contains battery, supercapacitor and load connected in parallel to each other. The second experiment is done by connecting the stand-alone of the supercapacitor into the equivalent circuit. A battery rated at 12V connected in parallel with a supercapacitor rated at 5.5V 1F. The circuit consist a voltage regulator to protect the supercapacitor form experiencing the over-voltage situation. A unit of light emitting diode (LED) with the forward voltage at 20mA, 1.8V also connected in parallel used as DC load with limiting resistor 480 ohms. The current sensor connected to the Science Workshop 750 Interface is used to detect and measure the current flow through the load [25] [26]. The R1 is rated at 0.525 ohms [27], R2 is rated at 0.24 ohms [27], and R3 at 480 ohms [27].

### 3.3.1.3 Battery/ 2SCs in parallel combination



**Figure 12: 2 SCs combined in parallel with battery**

A battery rated at 12V connected in parallel with two supercapacitors rated at 5.5V 2F. **Figure 12** show the circuit consist a voltage regulator to protect the supercapacitor form experiencing the over-voltage situation. A unit of light emitting diode (LED) with the forward voltage at 20mA, 1.8V also connected in parallel used as DC load with limiting resistor 480 ohms. The current sensor connected to the Science Workshop 750 Interface is used to detect and measure the current flow through the load [25] [26]. The R1 is rated at 0.525 ohms [27], R2 is rated at 0.24 ohms [27], and R3 at 480 ohms [27].

### 3.3.1.4 Battery/ 3SCs in parallel combination

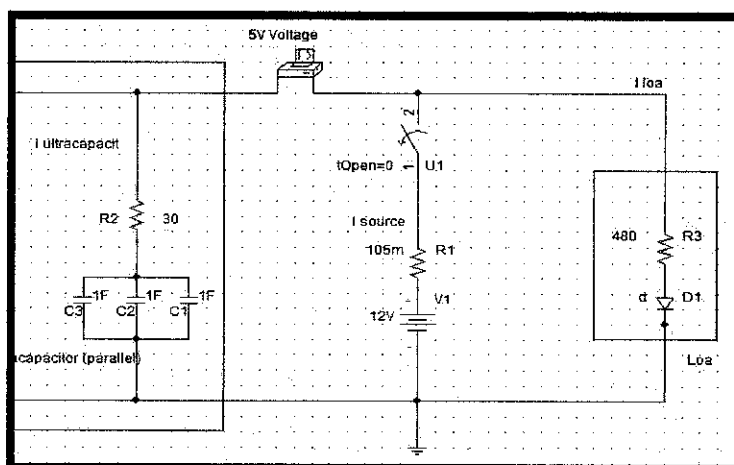

**Figure 13: 3 SCs combined in parallel with battery**

A battery rated at 12V connected in parallel with three supercapacitors rated at 5.5V 2F. **Figure 13** show the circuit consist a voltage regulator to protect the supercapacitor form experiencing the over-voltage situation. A unit of light emitting diode (LED) with the forward voltage at 20mA, 1.8V also connected in parallel used as DC load with limiting resistor 480 ohms. The current sensor connected to the Science Workshop 750 Interface is used to detect and measure the current flow through the load [25] [26]. The R1 is rated at 0.525 ohms [27], R2 is rated at 0.24 ohms [27], and R3 at 480 ohms [27].

## CHAPTER 4

### RESULT AND DISCUSSION

#### 4.1 Results

##### 4.1.1 *The voltage drop*

##### 4.1.1.1 *The voltage drop across the solar charging battery*

$$\begin{aligned}\text{Total voltage drop, } V_d &= I * IR \quad \dots(8) \\ &= 0.016A * 0.525 \Omega \\ &= 8.4 \text{ mV}\end{aligned}$$

##### 4.1.1.2 *The voltage drop across the battery/1 SC combination*

$$\begin{aligned}\text{Total voltage drop, } V_d &= (I * ESR) + (\Delta t * I/C) \quad \dots(9) \\ &= (0.016A * 0.525) + (0.02 * 0.016A / 1F) \\ &= 1.6 \text{ mV}\end{aligned}$$

##### 4.1.1.3 *The voltage drop across the battery/2 SCs combination*

$$\begin{aligned}\text{Total voltage drop, } V_d &= (I * ESR) + (\Delta t * I/C) \quad \dots(9) \\ &= (0.016A * 0.08) + (0.02 * 0.016A / 2F) \\ &= 1.44 \text{ mV}\end{aligned}$$

##### 4.1.1.4 *The voltage drop across the battery/3 SCs combination*

$$\begin{aligned}\text{Total voltage drop, } V_d &= (I * ESR) + (\Delta t * I/C) \quad \dots(9) \\ &= (0.016A * 0.08) + (0.02 * 0.016A / 3F) \\ &= 1.39 \text{ mV}\end{aligned}$$

#### 4.1.2 *The discharging rate of the supercapacitor*

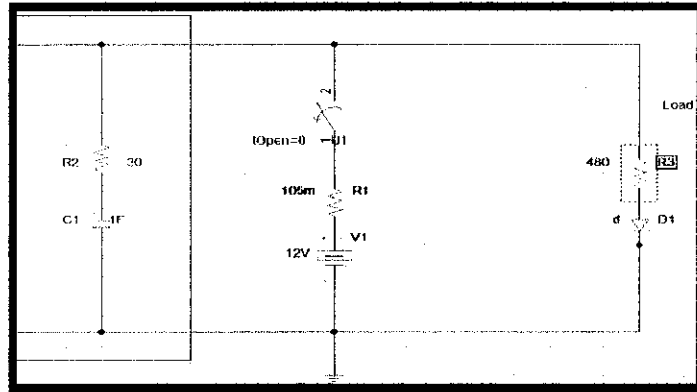

**Figure 14: Investigating the discharge time of SC**

Average discharging time of the SC is given by;

$$T_{\text{average}} = (t_1 + t_2 + t_3 + \dots + t_n) / n \quad \dots(10)$$

**Figure 14** show the circuit diagram to investigate the discharging time in the supercapacitor by using the battery as the power source that supply DC current to the circuit. The 1.0F, 5.5V supercapacitor was used to investigate the discharging time right after the switch at the power source is open. The experiment was continued by using 2.0F, 5.5V and 3.0F, 5.5V to investigate the effect of the capacitance to the discharging time of the supercapacitor. The charging time for supercapacitors are varied starting from 1 minutes, 3 minutes, 6 minutes, 9 minutes, 12 minutes and 15 minutes. All the data obtained from the experiment is gathered in **Table 4**.



**Table 4: The discharging time of SC right after the switch is opened**

Charging time (min)	Discharging time (min)	1.0F, 5.5V	2.0F, 5.5V	2.0F, 5.5V
		1 SC	2 SCs	3SCs
1		9.12	10.26	11.16
3		9.14	10.11	11.26
6		9.21	10.16	11.25
9		9.13	10.25	11.28
12		9.22	10.22	11.30
15		9.20	10.28	11.29

From the table above, the average discharging time can be calculated using formula;  $T_{\text{average}} = (t_1 + t_2 + t_3 + \dots + t_n) / n$  ....(10)

For 3.0F, 5.5V, the average discharging time is  $67.54/6 = 11.26$  minutes

For 2.0F, 5.5V, the average discharging time is  $61.28/6 = 10.21$  minutes

For 1.0F, 5.5V, the average discharging time is  $55.02/6 = 9.17$  minutes

#### 4.1.2.1 *The output current waveform for Section 3.3.1.2*

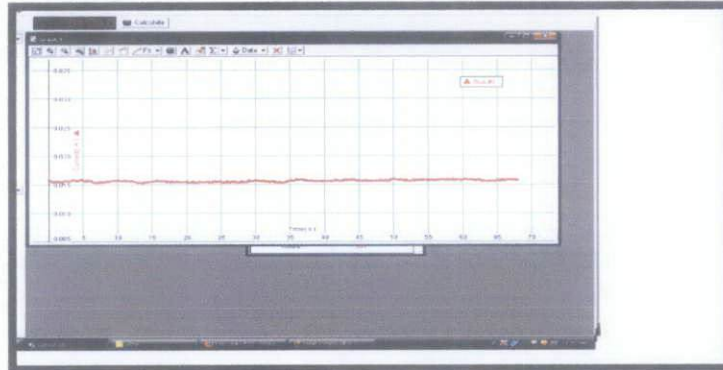

**Figure 15: Output current through load**

Figure 15 show the output current that flow through the load for battery combined with 1 SC. The same graph occurred for battery combined with 2 SCs and battery combined with 3 SCs. The results conclude the output current at load does not affected by the increasing capacitance value.

#### 4.1.2.2 *The output current waveform for Section 3.3.1.2*



**Figure 16: Output current waveform through 1 SC**

Figure 16 show the output current that flow through the supercapacitor for battery combined with 1 SC. The graph varied for different value of capacitance when the number of supercapacitors is increased.

#### 4.1.2.3 *The output current waveform for Section 3.3.1.3*

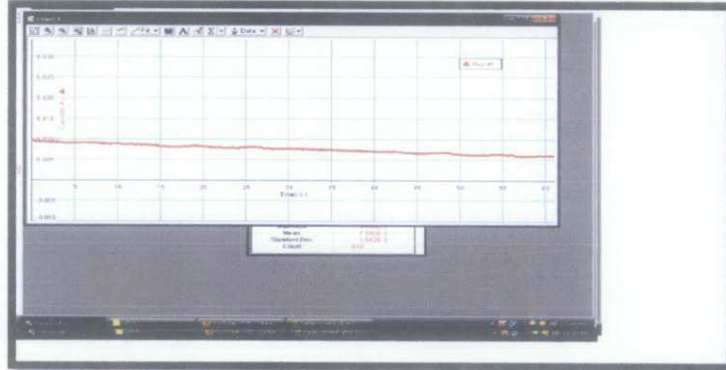

**Figure 17: Output current waveform through 2 SCs**

Figure 17 shows the output current that flows through the supercapacitor for a battery combined with 2 SCs. The graph varies for different values of capacitance when the number of supercapacitors is increased.

#### 4.1.2.4 *The output current waveform for Section 3.3.1.4*

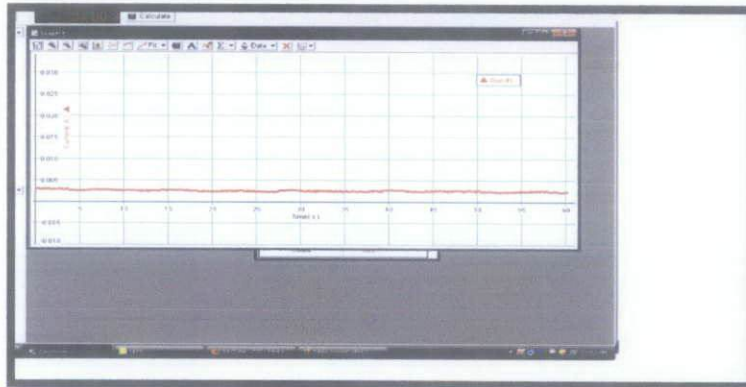

**Figure 18: Output current waveform through 3 SCs**

Figure 18 shows the output current that flows through the supercapacitor for a battery combined with 3 SCs. The graph varies for different values of capacitance when the number of supercapacitors is increased. The entire graph data for output current is tabulated in **Table 6** and Section 4.2.3 will discuss further the relationship between current and capacitance value.

### 4.1.3 Calculation for power efficiency

Power efficiency is obtained using the circuit parameter. From the circuit, the parameter measured are,  $R_1$  is rated at  $0.525 \Omega$ ,  $R_2$  is rated at  $0.24 \Omega$ ,  $I_{\text{source,rms}}$  is rated at  $2.5 \text{ mA}$ ,  $I_{\text{rms}}$  is rated at  $7.623 \text{ mA}$ ,  $V_{\text{load}}$  measured is  $11.4 \text{ V}$ ,  $I_{\text{load}}$  measured is  $0.0016 \text{ A}$ , and the duty cycle,  $D$  is  $0.02$ .

The internal losses of the combination circuit

$$\begin{aligned} P_{\text{loss,source(c)}} &= R_1 I_{\text{source,rms}}^2 + R_2 I_{\text{SC,rms}}^2 \dots(11) \\ &= (0.525) (7.623\text{m})^2 + (0.24)(2.5\text{m})^2 \\ &= (3.05 \times 10^{-5}) + (1.5 \times 10^{-6}) \\ &= 3.2 \times 10^{-5} \text{ W} \end{aligned}$$

The losses of the source (battery) in the circuit without SC

$$\begin{aligned} P_{\text{loss,source}} &= R_1 I_{\text{load}} (\sqrt{D}) \dots(12) \\ &= (0.525) (0.016) (\sqrt{0.02}) \\ &= 1.188 \times 10^{-3} \text{ W} \end{aligned}$$

The power loss reduction when with the use of SC ( $\Delta P$ )

$$\begin{aligned} \Delta P &= P_{\text{loss,source}} - P_{\text{loss,source(c)}} \dots(13) \\ &= (1.188 \times 10^{-3}) - (3.2 \times 10^{-5}) \\ &= 1.156 \times 10^{-3} \text{ W} \end{aligned}$$

The normalization of the power loss ( $\Delta P_n$ )

$$\begin{aligned} \Delta P_n &= (\Delta P) / P_{\text{loss, source}} \dots(14) \\ &= (1.156 \times 10^{-3}) / (1.188 \times 10^{-3}) \\ &= 0.973 \text{ W} \end{aligned}$$

The output power of the system ( $P_{out}$ )

$$\begin{aligned} P_{out} &= V_{load} I_{load} (\sqrt{D}) \dots(15) \\ &= (11.4) (0.016) (\sqrt{0.02}) \\ &= 0.0258 \text{ W} \end{aligned}$$

The output power of the system ( $P_{out}$ )

$$\begin{aligned} \eta &= [P_{out} / P_{in}] \times 100\% \dots(16) \\ &= 0.0258 \text{ W} / 0.1824 \text{ W} \\ &= 14\% \end{aligned}$$

## 4.2 Discussion

### 4.2.1 *Supercapacitor reduce the voltage drop of the battery*

#### i) Voltage drop without SC

From the calculation in Section 4.1.1, the rated voltage,  $V_d$  of the battery operate in the conventional circuit equal to 12.6V with peak pulse current,  $I$  equal to 0.016A. The typical lead acid battery internal resistance,  $IR$  is 0.525 ohms [27]. The time pulse width,  $\Delta t$  of the current waveform is equal to 0.02 seconds. By using the equation (8), the total voltage drop in the conventional circuit without the installation of the supercapacitor is 8.4mV.

ii) Voltage drop with SC

By combining supercapacitor(s) with battery and they are connected in parallel to each other, the value of capacitance was increase. The internal resistance, IR is 0.08 ohms which is less than the internal resistance, IR of the battery [27]. Using equation (9), the voltage in battery and supercapacitor combination circuit with reduced.

From the statement above, the data is tabulated in **Table 5**. The voltage drop in the circuit without the SC is higher compared to the voltage drop in the circuit with SC(s). As the voltage drop is large, the battery will not function properly. As the number of voltage change in the battery will affect the internal layer of the lead acid battery as well as to the other type of battery. This condition will increase the number of leakage current thus contribute to shorten the battery life. By connecting the SC with the battery, the number of voltage drop is reduced. Then the leakage current also will be reduce thus prolong the lifespan of the battery. [7]

**Table 5: Total voltage drop for each circuit orientation**

Circuit orientation	Total voltage drop, Vd
No SC	8.4mV
Battery/1 SC	1.6mV
Battery/2 SCs	1.44mV
Battery/3 SCs	1.39mV

#### 4.2.2 Analysis of the discharging rate of the supercapacitor

From **Table 4** in Section 4.1.2, the discharging time of the three supercapacitors connected in parallel to each other (3F) is longer than the discharging time of the only one supercapacitor (1F). The value of capacitance affects the discharging time of the supercapacitor; as the capacitance of the supercapacitor is increased, the longer the discharging time of the supercapacitor. The circuit that provide the longer discharging time will produce flatter voltage drop for the battery.

**Figure 19** show the discharge time waveform for circuit of battery with 3 SCs combination is more stable compared to the other circuit. This equivalent circuit has great potential to improve the solar supercapacitor application.

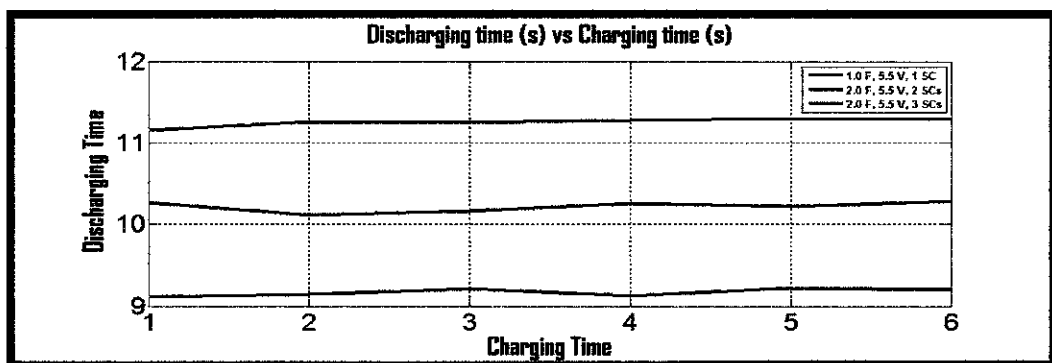

**Figure 19: Discharging rate of supercapacitor for different circuit orientation**

4.2.3 *Analysis of the output current for the equivalent circuit*

**Table 6: Output current for each circuit orientation**

Current (A)	Capacitance (F)	1 SC	2 SCs in parallel	3 SCs in parallel
		5.5V, 1F	5.5V, 2F	5.5V, 3F
Current across the load, for solar charging battery (no SC)		0.016	0.016	0.016
Current across SC(s)		4.3 m	9.58m	2.99m
Current across battery combined with SC(s)		7.8m	8.24m	8.97m

Referring to the results obtained in section 4.1.2, there are three current waveforms for each circuit arrangement taken into consideration to investigate the battery output power. According to the **Table 6**, for the standalone SC and SC(s) in parallel connection, the rated voltage remains constant at 5.5V while the current is 0.016A. Output current across the supercapacitor reduced as the capacitance value increase. When the supercapacitor is combined with the battery, the output current across battery is reduced, as the capacitance value increase.

From measurement of the experiment, for the standalone SC circuit arrangement the peak current across the battery in the equivalent circuit without the supercapacitor is higher than the peak current of the current across the battery in battery with supercapacitor combination circuit. The peak current across the



battery with supercapacitor combination circuit is decreased because the equivalent series resistance (ESR) of the battery is reduced due to combination with the supercapacitor.

At this rate, the lower values of ESR maximized the potential of the remaining current in a discharging battery [28]. With the reference to Ohms Law,  $V = IR$  [22], if resistance is reduced, the current across the battery will increase. Thus the voltage across the battery is increased. The higher voltage value will flatten the voltage drop across the battery. Flattening the voltage drop is referred to as the minimal and slightly reducing of the voltage drop line across the battery [29]. The smooth line of the voltage drop prolongs the lifespan of the battery [7].

#### **4.2.4 Analysis**

As the current across the battery in battery with supercapacitor equivalent circuit is decreased, the internal power losses in battery are reduced. The equation (11) is used to calculate the power loss ( $\Delta P$ ). The supercapacitor which was connected in parallel to the battery minimized the losses of the battery thus improve the battery voltage drop as well as its efficiency [30]. From the output power obtained in the equation (15), the efficiency of the system was determined by applying the equation (16). It is proven that the efficiency of power loss for battery stand-alone compared to battery combined with the supercapacitor is increased by 14 percent.

From the discussion above, the circuit that has three supercapacitors connected in parallel to each other was the best circuit to combine with the battery to improve the voltage drop and longer the discharging time of battery. This circuit also has a better output current waveform which means a smooth output current waveform. Referring back to the discharging time and output current waveform gained from all the experiments, the circuit with a capacity of 3F is the feasible combination circuit.

## CHAPTER 5

### CONCLUSION AND RECOMMENDATION

#### 5.1 Conclusion

As the conclusion on this study, a working equivalent circuit model for battery with supercapacitor combination was found. From the results of the experiment in **Section 4.1.1** and **Section 4.1.2**, the values of the capacitance (measure in Farad) affect the voltage drop across the battery as well as discharging time of the supercapacitor. The higher the value of the capacitance the lower the voltages drop across the battery. The higher the value of the capacitance also longer the discharging time as it was recorded in **Section 4.1.2** compared to the lower value of the capacitance. Then the parallel connection of the supercapacitor has better discharging time as compared to the standalone supercapacitor and battery alone (solar discharging battery).

The battery with supercapacitor combination equivalent circuit provides less battery internal power losses which improve the current of the battery in the equivalent circuit. Furthermore, the supercapacitor lowered the equivalent series resistance (ESR) of the battery which contributed to the better performance than the circuit without the supercapacitor.

This experiment proved that the supercapacitor was compatible with combination of the battery to improve the battery storage capacity for solar systems. The finding from this project show the voltages drop of the battery is flattered by extended discharging time of the supercapacitor. The potential of this result and findings can contribute to the environmental issues that have been raised before and improve the power source for the solar power systems application.

## 5.2 Limitations

The experiment was done using the stand-alone solar power systems, because of the portability and small storage capacity of the alkaline battery to power up small load, for example LED. For industry, the solar power systems use the on-grid solar power systems, thus it require a larger storage capacity. For this system, lead-acid battery is used to power up larger amount of load. Although the voltage drop of the battery can be calculated using the same formula, the effect of the voltage drop for both type of battery are different depends on the ambient temperature [30]. The experimentation is limited on alkaline type of battery only, because it is portable with stand-alone solar power systems.

Besides the advantages that supercapacitor offers, it also has the disadvantage. The supercapacitor voltage is varying with the energy stored. Thus, to effectively used supercapacitor to improve the storage systems, sophisticated electronic control is needed [31]. The electronic control could be very expensive as well as complicated which inadequate for the project.

### 5.3 Recommendations

Throughout the experiment, there were some lack parameters or precautions taken. The experiment shall be conducted in the same surrounding temperature because the temperature affects the battery performance. The voltage drop of battery may vary for different ambient temperature. This will avoid the inconsistencies of the supplied voltage from the battery and to maintain the same initial voltage produced by the battery that will affect the experimental value [30].

The conventional capacitor shall be used to reduce the noise in the equivalent circuit to get better output current waveform [19]. The better output current waveform will provide better rms current value which used in the calculation to obtain power efficiency.

Use sophisticated electronic control circuit to effectively store energy because the supercapacitor voltage is varying with the energy stored in the battery [31]. Battery as we know is affected by the ambient temperature.

As the researcher want to handle the electrical parameters, always refer to the datasheet in order to avoid any unwanted situations such as burning component and short-circuited. This procedure is to train the researcher to apply the safety, health and environment issues in handling the electrical or electronic component [32].

## REFERENCE

- [1] Miller, J. M. (2004, June). *Ultracapacitor Challenge the Batteries*. Retrieved 12.06.2011, from WorldandI.com:  
[http://www.worldandi.com/subscribers/feature\\_detail.asp?num=23938](http://www.worldandi.com/subscribers/feature_detail.asp?num=23938)  
<http://electronics.howstuffworks.com/capacitor3.htm>
- [2] Rand, R. D. (2001). *Understanding Batteries*. Cambridge, UK: The Royal Society of Chemistry :  
<http://www.reuk.co.uk/Lead-Acid-Batteries.htm>
- [3] Buchmann, I. (n.d.). *www.batterydigest.com*. Retrieved 19.06.2011, from Battery Digest:  
[http://www.batteriesdigest.com/capacity\\_\\_the\\_key\\_to\\_battery\\_runtime\\_.htm](http://www.batteriesdigest.com/capacity__the_key_to_battery_runtime_.htm)
- [4] Lecard, M. (1993, Nov-Dec). *Recharge it-batteries and environmental pollution*. Retrieved 13.06.2011, from BNet:  
[http://findarticles.com/p/articles/mi\\_m1525/is\\_n6\\_v78/ai\\_14263165/](http://findarticles.com/p/articles/mi_m1525/is_n6_v78/ai_14263165/)
- [5] Bishop, A. L. (2005). The Effect of Temperature on Battery Life. *California State Science Fair*.
- [6] G.L Bullard, H. S.-A. (1989). Operating Principle of the Ultracapacitor. *IEEE Transaction on Magnetics*, page 102-106.
- [7] Lead-Acid Battery. Retrieve 10.04. 2011, from Hyperphysics:  
<http://hyperphysics.phy-astr.gsu.edu/hbase/electric/leadacid.html>

- [8] Bright Green Energy. Retrieved 14.06.2011:  
[http://www.wirefreedirect.com/battery\\_capacity.asp](http://www.wirefreedirect.com/battery_capacity.asp)  
<http://pvcdrum.pveducation.org/BATTERY/charge.htm>  
<http://homepages.which.net/~paul.hills/Batteries/BatteriesBody.html>
- [9] Suchitra Sriram (2006). Impediments to Growth. Solar Power in Malaysia.  
Retrieved 13.06.2011 from Frost & Sullivan:  
<http://www.frost.com/prod/servlet/market-insight-top.pag?docid=67575287>
- [10] Application of Solar Energy. Retrieved 15.06.2011:  
<http://www.slideshare.net/iloilolodge/application-of-solar-energy>
- [10] The encyclopedia of alternative energy and sustainable living. Retrieved 16.06.2011:  
[http://www.daviddarling.info/encyclopedia/S/AE\\_solar\\_power\\_system.html](http://www.daviddarling.info/encyclopedia/S/AE_solar_power_system.html)
- [11] The Sun Energy - Photovoltaics and Photovoltaic Systems. Retrieved 16.06.2011:  
[http://inventors.about.com/od/sstartinventions/a/solar\\_cell.htm](http://inventors.about.com/od/sstartinventions/a/solar_cell.htm)
- [12] Solar Panel, the types of solar panel. Retrieved 16.06.2011:  
<http://www.solarvoltaic.com/>
- [13] Solar Panel Datasheet and parameters. Retrieved 17.06.2011:  
<http://www.lelong.com.my/5w-solar-panel-module-85393012-2012-06-Sale-P.htm>
- [14] Bakhoun, E. G. (January 2009). New Mega-Farad Ultracapacitor. *IEEE Transaction on Ultrasonic, Ferroelectrics, and Frequency Control*, page 14-21.
- [15] Kozierok, C. M. (2001, 4 17). *Basic Electrical Components*. Retrieved 20.06.2011:  
<http://www.pcguide.com/intro/fun/components.htm>

- [16] Function of Supercapacitor. Retrieved 20.06.2011:  
[http://batteryuniversity.com/learn/article/whats\\_the\\_role\\_of\\_the\\_supercapacitor](http://batteryuniversity.com/learn/article/whats_the_role_of_the_supercapacitor)
- [17] Drexel University. Retrieved 21.06.2011:  
<http://www.gizmag.com/ultrahigh-power-energy-storage-microsupercapacitor/1607>
- [18] Pico, F., J. M. Rojo, et al. (2004). "Single-walled carbon nanotubes as electrodes in supercapacitors." *Journal of the Electrochemical Society* 151(6): A831-A837.
- [19] Du, C. S., J. Yeh, et al. (2005). "High power density supercapacitors using locally aligned carbon nanotube electrodes." *Nanotechnology* 16(4): page 350-353.
- [20] SOL Life Malaysia , Solar (Photovoltaic) Power - Reliable Renewable Energy  
[http://www.sol-malaysia.com/solar\\_power\\_system.htm](http://www.sol-malaysia.com/solar_power_system.htm)
- [21] Kuldeep Sahay and Bharti Dwivedi, Design and analysis of supercapacitors energy storage systems for energy stabilization of distribution network. *Uttar Pradesh Technical University, Lucknow*.  
<http://www.scribd.com/doc/15049303/Design-and-Analysis-of-Supercapacitors-Energy-Storage-System-for-Energy-Stabilization-of-Distribution-Network>
- [22] Charles K. Alexander, M. N. (2007). *Fundamentals of Electric Circuits* (Vol. 3rd Edition). Mc Graw Hill.
- [23] Escol Electronics Trading. (n.d.). *LEDs and Display*. Retrieved 28.07.2011:  
[www.escol.com.my](http://www.escol.com.my): <http://www.escol.com.my/LEDs.html>
- [24] All About Circuit: Internal Resistance of a Battery. Retrieved 14.7.2011:  
<http://forum.allaboutcircuits.com/archive/index.php/t-45600.html>

- [25] PASCO. (1996-2010). Retrieved 08.08 2011: from [www.pasco.com](http://www.pasco.com):  
<http://www.pasco.com/featured-products/scienceworkshop-750/index.cfm>
- [26] Hewes, J. (2010). *Multimeter*. Retrieved 18.08. 2011:  
<http://www.kpsec.freeuk.com>: <http://www.kpsec.freeuk.com/multimtr.htm>
- [27] *Explaining rms voltage and current*. Retrieved 11.05.2011, from Practical Physics:  
[http://www.practicalphysics.org/go/Guidance\\_107.html](http://www.practicalphysics.org/go/Guidance_107.html)
- [28] Eichenberg, D. J. *Hybrid Power Management Program Evaluated Fuel Cell/Ultracapacitor Combinations and Developed Other New Applications*. Retrieved 10. 5.2011, from [grc.nasa](http://www.grc.nasa.gov):  
<http://www.grc.nasa.gov/WWW/RT/2003/7000/7720eichenberg.html>
- [29] Meisam Amiri, M. E.-Y. (2009). Minimization of power losses in hybrid electric vehicles in view of the prolonging of battery life. *Journal of Power Sources* , page 372-379.
- [30] Chad Hall, I. i. *Automotive Engineer & Ultracapacitor*. Retrieved 10.05.2011, from EE Times Design:  
<http://www.eetimes.com/design/power-management-design/4012541/Automotive-Engineers--Ultracapacitors-What-s-Next-for-Energy-Storage>
- [31] G.L Bullard, H. S.-A. (1989). Operating Principle of the Ultracapacitor. *IEEE Transaction on Magnetics* , page 102-106.
- [32] Datasheet. (2008). Technical Specification. Retrieved 10.05.2011 :  
*Alkaline* , [www.panasonic-industrial.com](http://www.panasonic-industrial.com).



**Gantt chart for the First Semester of 2-Semester Final Year Project.**

	1	2	3	4	5	6	7	8	9	10	11	12	13	14
<b>1</b>	<b>Selection of Project Topic</b>													
	-Identified the problem													
	-Conformation of title project													
<b>2</b>	<b>Preliminary Research Work</b>													
	-Collect all date required													
	-Identify the software and tools needed													
<b>3</b>	<b>Submission of Preliminary Report</b>													
<b>4</b>	<b>Seminar 1</b>													
<b>5</b>	<b>Project Work</b>													
	-Experiment and circuit design													
<b>6</b>	<b>Submission of Progress Report</b>													
	-Literature review and theory													
<b>7</b>	<b>Seminar 2 (compulsory)</b>													
<b>8</b>	<b>Project work continues</b>													
	-Verify working prototype													
<b>9</b>	<b>Submission of Interim Report Final Draft</b>													
<b>10</b>	<b>Proposal Defense Presentation</b>													

**Gantt chart for the Second Semester of 2-Semester Final Year Project.**

No.	Detail/Week	1	2	3	4	5	6	7	8	9	10	11	12	13	14
1	Project Work Continue														
2	Submission of Progress Report														
3	Project work continue														
4	Poster Exhibition (Electrex)														
6	Submission of Draft Report														
7	Submission of Dissertation (soft bound)														
8	Oral Presentation														
9	Submission of Final Project Report														

**APPENDIX B**

**GRAPH GAINED FROM THE EXPERIMENT FOR SECTION 4.1.2,  
TABLE 6**

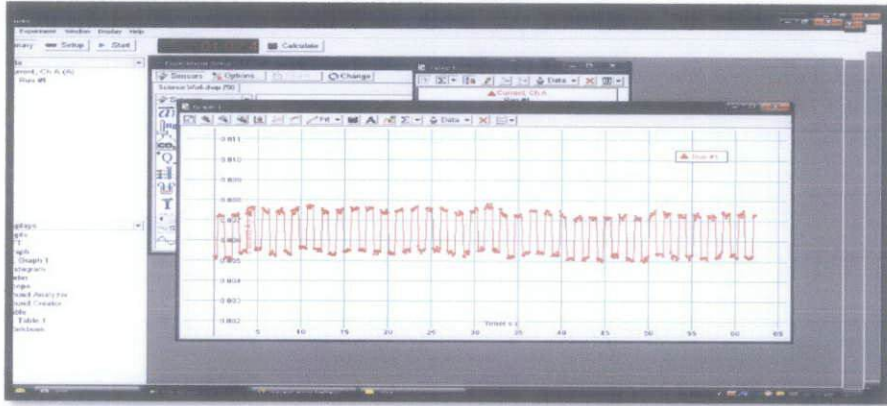

**Figure 20: Current waveform through battery/1SC**



**Figure 21: Current waveform through battery/ 2 SCs**

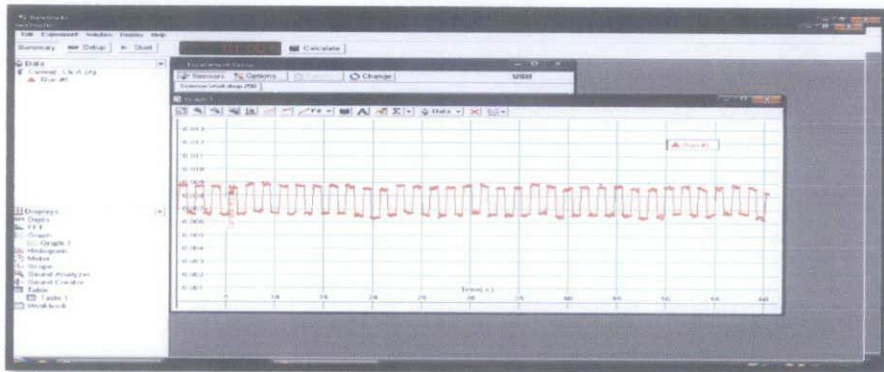

**Figure 22: Current waveform through battery/ 3 SCs**