

**HOME SECURITY SYSTEM: SMOKE DETECTOR CIRCUIT,
TEMPERATURE DETECTOR CIRCUIT WITH KEYPAD AND LCD
INTERFACE**

By

SITI ZURAIDAH BINTI MAIL

FINAL PROJECT REPORT

Submitted to the Electrical & Electronics Engineering Programme
in Partial Fulfillment of the Requirements
for the Degree
Bachelor of Engineering (Hons)
(Electrical & Electronics Engineering)

Universiti Teknologi Petronas
Bandar Seri Iskandar
31750 Tronoh
Perak Darul Ridzuan

© Copyright 2007

by

Siti Zuraidah Binti Mail, 2007

CERTIFICATION OF APPROVAL

HOME SECURITY SYSTEM: SMOKE DETECTOR CIRCUIT, TEMPERATURE DETECTOR CIRCUIT AND LCD DISPLAY

by

Siti Zuraidah Binti Mail

A project dissertation submitted to the
Electrical & Electronics Engineering Programme
Universiti Teknologi PETRONAS
in partial fulfilment of the requirement for the
Bachelor of Engineering (Hons)
(Electrical & Electronics Engineering)

Approved:



Dr. John Ojur Dennis
Project Supervisor

UNIVERSITI TEKNOLOGI PETRONAS
TRONOH, PERAK

JUNE 2007

CERTIFICATION OF ORIGINALITY

This is to certify that I am responsible for the work submitted in this project, that the original work is my own except as specified in the references and acknowledgements, and that the original work contained herein have not been undertaken or done by unspecified sources or persons.



Siti Zuraidah Binti Mail

ABSTRACT

The Home Security System is design to develop a security system that is affordable and easy to use. This system will provide protection when user is at home and not at home. It will have a LCD display as an easy and friendly interface and a keypad as a main controller to the whole system. The keypad will allow a communication between the user and the system. This project is divided into three main parts which are the smoke detector circuit implementation, temperature detector implementation and the LCD and keypad implementation. The three parts have slightly different methodology but in overall, the project started by doing research on the circuits, the implementation of the circuits and the implementation of the LCD display and keypad. The system will have a complete home security system that will enable user to control the circuits with a keypad. In future, more circuits will be included in the system that will provide more diversity in home security system.

ACKNOWLEDGEMENTS

In the name of Allah, the Most Gracious and the Most Merciful, the utmost thanks to Allah for giving the opportunity to complete the research and study about Smart Home Security System, even with some problems faced throughout the project undertaking

Greatest appreciation and gratitude to the Final Year Project supervisor, Dr. John Ojur Dennis for his help, supervision, commitment, professionalism, advice and guidance throughout the semester

A special acknowledgement and appreciation goes to

- Electrical and Electronics Department for the support
- Electrical Technicians, Miss Siti Hawa for the guidance and advice
- Colleagues for the encouragement

Last but not least, special thanks to those who had helped directly or indirectly in undertaking this project throughout the semester. The contributions and insights are highly appreciated

TABLE OF CONTENTS

| | |
|--|----|
| LIST OF TABLES | ix |
| LIST OF FIGURES | x |
| LIST OF ABBREVIATIONS | xi |
| CHAPTER 1 INTRODUCTION | 1 |
| 1.1 Background of Study | 1 |
| 1.2 Problem Statement | 2 |
| 1.3 Objectives | 3 |
| 1.4 Scope of Study | 3 |
| CHAPTER 2 LITERATURE REVIEW | 4 |
| 2.1 Introduction | 4 |
| 2.2 Implementation | 5 |
| CHAPTER 3 METHODOLOGY | 7 |
| 3.1 Research and Collecting the Components | 7 |
| 3.2 Circuit Development | 9 |
| 3.3 Research on microcontroller, LCD Display and Keypad | 10 |
| 3.4 DataStudio PASCO | 12 |
| 3.5 Tools | 14 |
| CHAPTER 4 RESULTS AND DISCUSSION | 15 |
| 4.1 Smoke Detector Circuit – Testing and Troubleshooting | 15 |
| 4.2 LCD Display and Keypad | 17 |
| 4.3 Temperature Detector Circuit – Testing and Troubleshooting | 18 |
| 4.4 Complete Home Security System | 21 |
| CHAPTER 5 CONCLUSION | 23 |
| 5.1 Conclusion | 23 |
| 5.2 Recommendations | 24 |
| REFERENCES | 25 |
| APPENDICES | 26 |
| Appendix A Circuit’s pictures | 27 |
| Appendix B LCD and Keypad Coding | 28 |
| Appendix C PIC16F87X DATASheet | 33 |
| Appendix D Gantt Chart | 34 |

LIST OF TABLES

| | |
|---|----|
| Table 1 Table Output Voltage versus Smoke Intensity | 17 |
| Table 2 Output Voltage versus Temperature | 21 |

LIST OF FIGURES

| | |
|---|----|
| Figure 1 Block Diagram of the Home Security [4]..... | 5 |
| Figure 2 LDR (Light Dependent Resistor) | 6 |
| Figure 3 LM34/35 | 6 |
| Figure 4 Flow Chart of the Researches and Analysis | 8 |
| Figure 5 Flow Chart of the Circuit Development | 9 |
| Figure 6 Flow Chart of C Coding Development..... | 11 |
| Figure 7 PIC16F1877 Pin Layout | 12 |
| Figure 8 Easy drag-and-drop Setup..... | 12 |
| Figure 9 Data Panel..... | 13 |
| Figure 10 Display Panel..... | 13 |
| Figure 11 Schematic Diagram of Smoke Detector Circuit | 15 |
| Figure 12 Graph Output Voltage versus Smoke Intensity | 16 |
| Figure 13 Detailed Connection of PIC16F1877 microcontroller..... | 18 |
| Figure 14 Temperature Detector Schematic Circuit | 19 |
| Figure 15 Graph Output Voltage versus Temperature..... | 20 |
| Figure 16 The Complete Home Security System Schematic Diagram | 22 |
| Figure 17 Smoke Detector Circuit | 27 |
| Figure 18 LCD display and Keypad circuit | 27 |
| Figure 19 Temperature Detector Circuit..... | 27 |

LIST OF ABBREVIATIONS

| | | |
|--------|---|---|
| LDR | - | Light Dependent Resistor |
| LCD | - | Light Crystal Display |
| LED | - | Light Emitting Diode |
| Vout | - | Voltage Output |
| V | - | Volts |
| R | - | Resistance |
| °C | - | Celsius |
| F | - | Fahrenheit |
| RISC | - | Reduced Instruction Set Computer |
| CPU | - | Central Processing Unit |
| RAM | - | Random Access Memory |
| EEPROM | - | Electrically Erasable Programmable Read Only Memory |

CHAPTER 1

INTRODUCTION

1.1 Background of Study

The Home Security System is a system built to give extra precautions on safety of people and the safety of their belongings. It is a system that will enable the user to have a control of the circuits using the LCD display and the keypad.

The brain of this security system is the microcontroller that will control the input and output of the whole system. Normally the microcontrollers are initially 'blank' and then are programmed with a specific control program. The control program is written on a computer using interface software and then 'downloaded' into the microcontroller chip.

In this project the system consists of three parts of works, which are the smoke detector circuit, temperature detector circuit and the keypad and LCD display section. The Microcontroller interconnects the smoke detector, temperature detector and keypad to the alarm system.

The first part of the project is the smoke detector which is the most essential part because in this project, students are required to design their own smoke detector circuit using an LDR. There will be a need to conduct testing and measurement on the circuit to get a desired outcome for the circuit output.

The second part of the system which is the sensor circuit implementation is a part where the research and literature review of the circuit of temperature sensor is done

before the suitable circuit is selected to make sure in depth understanding on the circuit before the circuit is implement.

Meanwhile, the third part of the circuit involves the keypad and LCD display implementation. In this part, the programming is essential to process the input keypad to display the output to the LCD display and to connect the alarms and sensors to the LCD display.

1.2 Problem Statement

Fires are common accident that happens in residences everyday around the world. Some people may realize this but many people may not be aware of the importance of taking extra precaution to the safety of their houses. These issues require the implementation of Home Security System that consists of extra function to ensure the safety of the residence and the household.

Either we realize it or not, home fires are a serious threat to our family safety. Around 6000 or more people die and over 3000,000 are injured each year by fire in residences. These home fire injuries and deaths are mostly caused by smoke, not flames. An inside look and research gives a solution on how those frightening numbers can be decreased. From information in the internet many deaths and injuries occur in fires that happen at night, while the victims are asleep. A reliable way to awaken these sleepers before the smoke becomes dense would help more people escape uninjured. [1] There should be a law enforcement to oblige all houses in Malaysia to have a safety system in order to prevent those numbers of accident from increasing day by day.

This home security system will enables the user to control a smoke sensor and a temperature sensor with a keypad. The keypad will have an extra function that will allow the user to control the detectors. For the LCD display, the temperature will be displayed at the LCD for the temperature detector. The security system will sound an

alarm when there is a possible fire in the house or when a certain heat is detected by the temperature detector.

1.3 Objectives

Towards the end of this project there are a few objectives that need to be accomplishing to make sure of the success of this project.

The specific objectives of this research are:

- To design and construct a smoke and temperature detector circuit.
- To integrate the smoke and temperature detector circuit with a control and display circuit.
- To design a model prototype of the system integrated into the whole Home Security System.

1.4 Scope of Study

In this project the scope of study will be more on understanding and implementation on both smoke detector and temperature detector design. The study focuses on how to connect the detector circuits to the LCD display as well as to the output of the system. The cost and time frame of the system will be given priority whiles designing the system. The project is expected to be accomplished within one year. The followings are the study to be covered in this time frame:

- Literature review on the components that build a smoke sensor, a temperature sensor and a LCD display.
- Design and implementation of a simulation of the circuits
- Development of programming for the sensors output.
- Troubleshooting the Smart home security system circuits and observes the outcome.
- Analyze the outcome of the output and compare it with desired outcome
- Incorporation of all the major circuits into a functioning Home Security System.

CHAPTER 2

LITERATURE REVIEW

2.1 Introduction

Smoke detectors have come a long way since George Darby first invented it in 1902. Before scientists knew how to capture ionizing molecules in a small enclosed space, they actually used an open/close electrical system along with a wedge of butter to detect fires and heat. [2] It is an active fire protection device which can alert nearby people to any potential fire by detecting any airborne smoke and trigger an alarm. There are two types of most used smoke detectors which work either by optical detection or by ionization, but some of them use both detection methods to increase sensitivity to smoke. Smoke detectors may operate alone, be interconnected to cause all detectors in the premises to sound an alarm if one is triggered, or be integrated into a fire alarm or security system. Smoke detectors with flashing lights are available for the deaf or hearing impaired. [3]

In this technology world there is a ready-made temperature-to-voltage sensors which can be fetch from mail-order houses. By using this ready-made sensor package a temperature detector can be built in three simple steps. The steps that need to be done are to connect a power source (like a 9-volt battery) and a voltmeter. They generate 0.01 volts (10 mV) for every degree F (LM34) or degree C (LM35), so a temperature of 35 degrees would read 0.35 volts on the meter.

These two detector can stands on their own but in this smart home security system, the user can chooses on how to control their devices using a keypad and LCD display.

The smoke detector, temperature detector and keypad and LCD display are connected using the microcontroller. This system is made up of input and output devices and shown in figure 1. These devices are connected to a microcontroller that will interpret the input information from the sensors and develop the outputs to control the outputs devices. In the case of a fire alarm system the inputs may be smoke sensors, temperature detector and the keypad on the front of the control panel. The output devices are the display on the control panel as well as the external siren. Microcontrollers are powerful electronic components that have a memory and can be programmed to switch things on and off in a special sequence

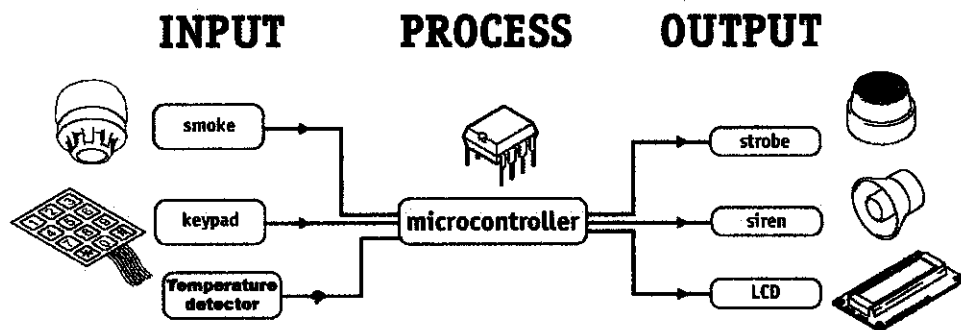

Figure 1 Block Diagram of the Home Security [4]

2.2 Implementation

The main circuit for the implementation of this project is the circuit of the smoke detector circuit. The main purpose for this project was to implement own smoke detector circuit. A smoke detector or smoke alarm is an active fire protection device which is uses to detect airborne smoke and trigger an audible alarm, thereby alerting nearby people to the danger of fire.

The smoke detector circuit that is use in this project is the photoelectric circuit that will detect the smoke by using the LDR. The LDR is connected to the alarm circuit that will become the output of the circuit.

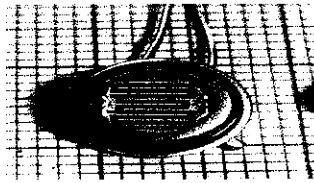

Figure 2 LDR (Light Dependent Resistor)

The temperature sensor is a circuit that incorporate National Semiconductor LM345DZ temperature sensor. All that needs to be done is to connect a power source (like a 9-volt battery) and a voltmeter (like a Digital Multimeter). That will generate 0.01 volts (10 mV) for every degree C (LM35).

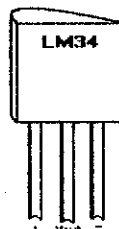

Figure 3 LM34/35

The software use to develop the programming language for the microcontroller is the CCS compiler. A compiler is a high level language translator that combines the programming ease of an interpreter with greater speed. This is accomplished by translating the program (on a host machine such as a desktop PC) directly into machine language. After finish the coding, it will be troubleshoot at the lab with the LCD and keypad circuit.

CHAPTER 3

METHODOLOGY

The methodology section is where the step for realizing the objectives for this project is outlined. Below are the steps taken in order for the objectives to be realized.

3.1 Research and Collecting the Components

Some researches have been conducted on the smoke detector circuit to study how the circuit works. This is shown in Figure 4 as the first step in doing literature review is research on problem and desired circuit. The part of the smoke detector alarm which is the dark activated alarm circuit with LDR needs to be build in order to make a full complete smoke detector circuit. The smoked detector circuit was build based on a dark-activated LED or lamp flasher circuit.

Research also had been done on the temperature detector circuit. Although the circuit for the temperature detector was quite simple because it consists of only a resistor and a temperature sensor which is the LM35DZ but the coding in order to make the temperature sensor display the temperature also needs to be created.

Before the circuit for both the sensor can be execute, a test on PSpice software needed to be conducted. But since the component in the program was quite limited, the perfect circuit and output cannot be generated using the software. When the research had been conducted for both of the circuits and the component had been listed down, then the search for the component was done as shown in figure 4.

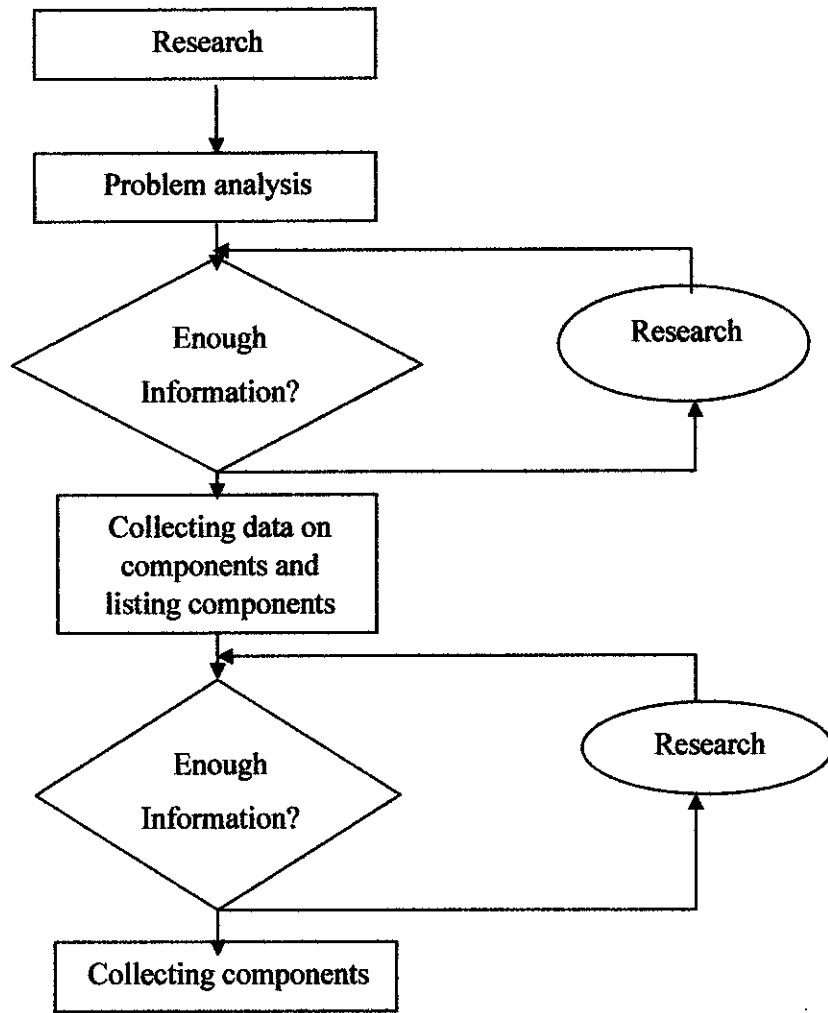

Figure 4 Flow Chart of the Researches and Analysis

3.2 Circuit Development

The development of the circuit is done based on steps shown in Figure 5. The flow chart shows that the first step takes is research on the circuits. The desired circuit is constructed on Pspice software and if there are problems in the simulation then the circuit is redo and if the simulation success then next step is implement.

The next step is constructing and testing the simulation of the circuit. This part requires testing and troubleshooting of the circuit on breadboard. If there are problems exist during the troubleshooting then the circuit needs to be redone and examine for the problems. If the circuit is working, the student will proceed to coding for keypad and LCD.

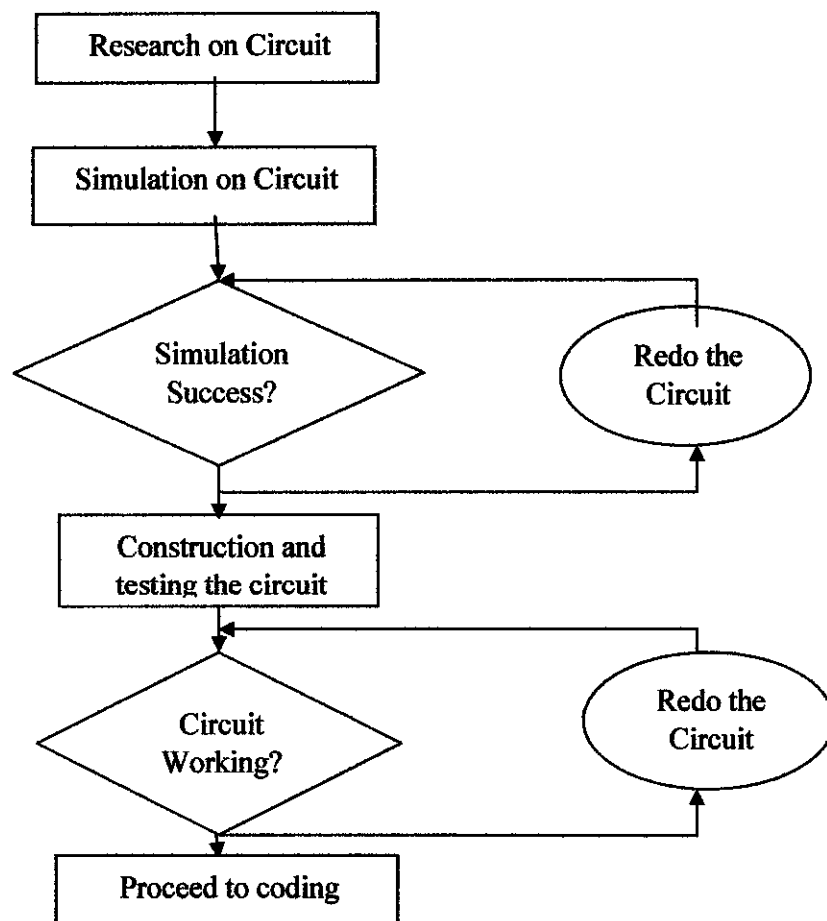

Figure 5 Flow Chart of the Circuit Development

3.3 Research on microcontroller, LCD Display and Keypad

The search for the keypad and LCD display is done to find on how to convert the input from the smoke detector, temperature detector and keypad into the output of a microcontroller to be displayed on a LCD display, alarm and LED. Research is done more on the connection of microcontroller as it will be used as a medium to interpret the input while the LCD display, siren and LED is only the outcome from the input. Research on the right microcontroller and the coding that going to be install in the microcontroller is also done.

As shown in figure 6, the construction of coding is done based on flow chart. Initial display is the display that will be on the screen as long as there is no error occurs or no button is push. The user can use keypad button 1, 2, 3 and F to browse through the menu of the LCD. Button 1 represent the current temperature, button 2 represent the condition of the smoke circuit, button 3 represent the condition of magnetic switch circuit and button F represent the reset button that will allows the user to return to the initial display condition.

If error occurs then the LCD will display the errors that occur and alarm will be trigger.

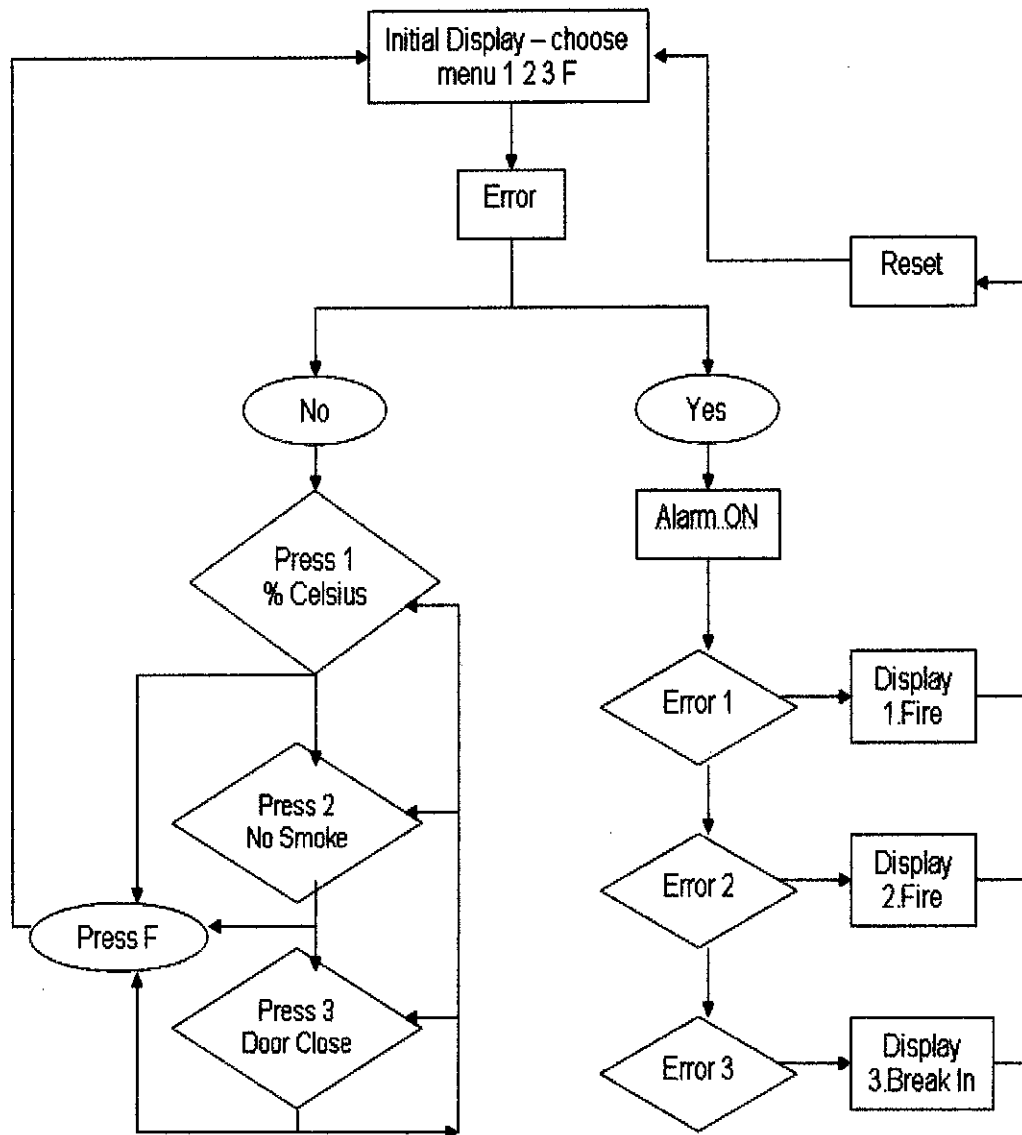

Figure 6 Flow Chart of C Coding Development

The PIC is a high performance RISC CPU. It operates at 4MHz and 25ms instruction per cycle. It contains three type of memory which is the FLASH Program Memory, Data Memory (RAM) and EEPROM Data Memory. The PIC16F877 as shown in figure 7 is a high-performance FLASH microcontroller that provides engineers with the highest design flexibility possible.

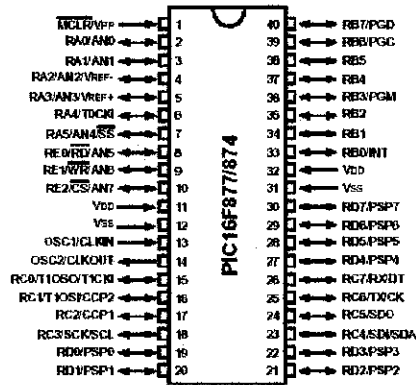

Figure 7 PIC16F1877 Pin Layout

3.4 DataStudio PASCO

DataStudio PASCO is all-in-one software that collects, displays, stores, and analyzes scientific data using a computer. [5] This software is use in this project to obtain the output graph of the smoke detector circuit and temperature detector circuit.

Figure 8 below shows the interface of DataStudio PASCO, this call an easy drag-and-drop setup. The user can drag any display icon over any sensor icon and data studio automatically plugs the sensor into the black component and creates the display. Data studio intelligently knows where the sensor can be plugged in and conveniently highlights the correct ports.

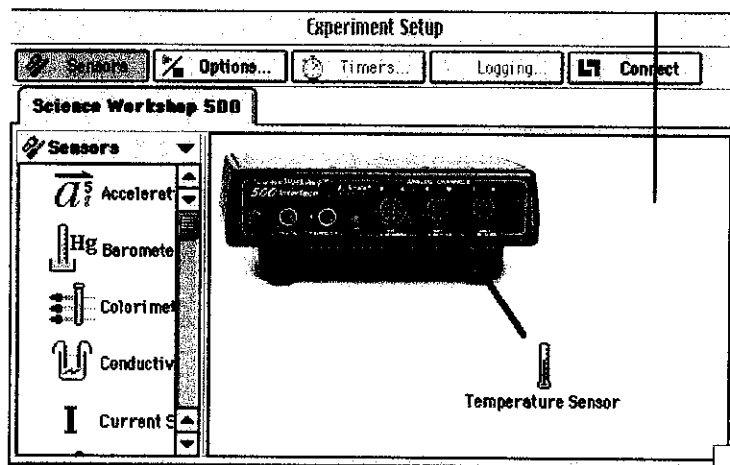

Figure 8 Easy drag-and-drop Setup

Figure 9 shows the data panel that is used to store data runs by measurement category or by run number. The data panel is placed on left side of the PASCO software. The data panel also record data run as many as possible depends on computer memory.

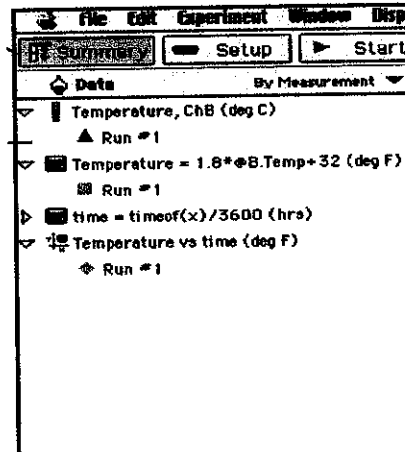

Figure 9 Data Panel

Display panel is show in figure 10 is a panel that shows all display available in data studio. This panel will tracks the types of displays created during any experiment. The display can be open from this display panel by dragging the display icon in the Setup window.

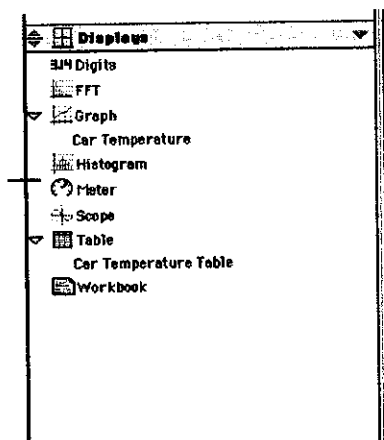

Figure 10 Display Panel

3.5 Tools

In this project, the tools that are used to assist in developing the Home Security System are as follows:

- MULTISIM
- CCS Compiler
- PSPICE
- DataStudio PASCO

List of testing equipment that is used in this project are:

- Multimeter
- DC power supply
- Digital thermometer
- Soldering equipment
- Vera Board
- LCD Display
- Keypad

CHAPTER 4

RESULTS AND DISCUSSION

4.1 Smoke Detector Circuit – Testing and Troubleshooting

Figure 11 shows the schematic diagram of the smoke detector circuit that works using LDR. As the light source continues to feed the LDR, the resistance in LDR will be low enough to allowed voltage to flow into transistor Q1 and turn it ON; this will automatically turn OFF Q2. As the light source is being increasingly blocked by smokes, the voltage through the transistor Q1 is linearly decreasing. The increases of smoke will reduces the voltage that can pass through Q1, Q2 in the other hand will increasingly ON and the alarm will also be triggered as Q2 ON.

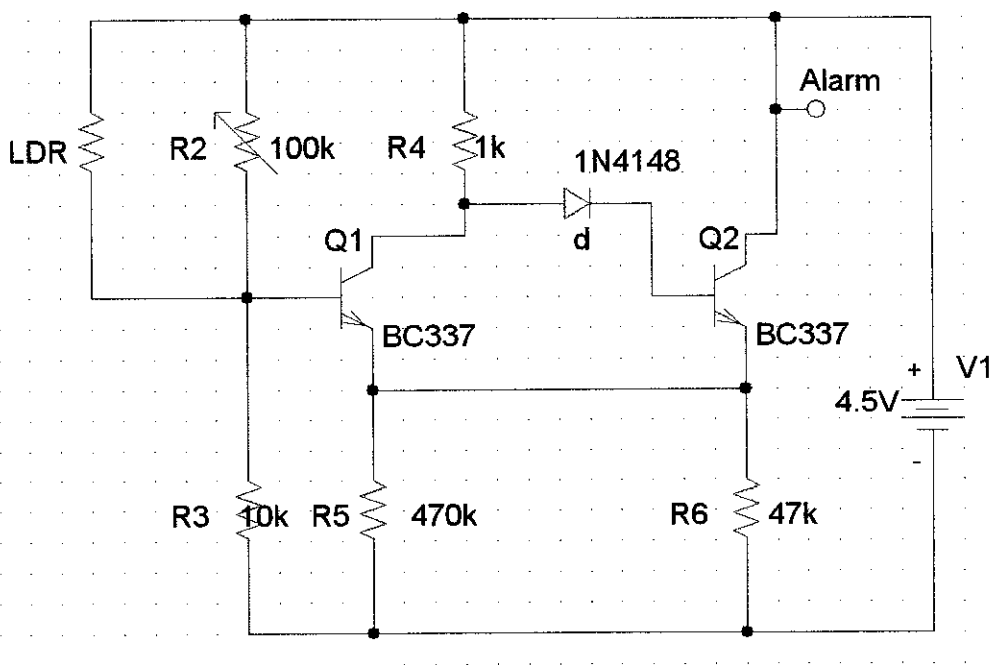

Figure 11 Schematic Diagram of Smoke Detector Circuit

Refer *Appendix A* for Picture of Smoke Detector Circuit

The approximate graph of output voltage versus smoke intensity is shown in figure 12. The graph is obtained using DataStudio PASCO software. Intensity 1 has the lowest smoke intensity and intensity 5 has the highest intensity. In figure 9, Intensity 1 is the condition where the smoke condition is not enough to trigger the alarm. When the circuit reach the smoke intensity 2, the voltage increase to 3 Volt that enough to trigger the alarm. When the intensity of the smoke increases the voltage output will also increase.

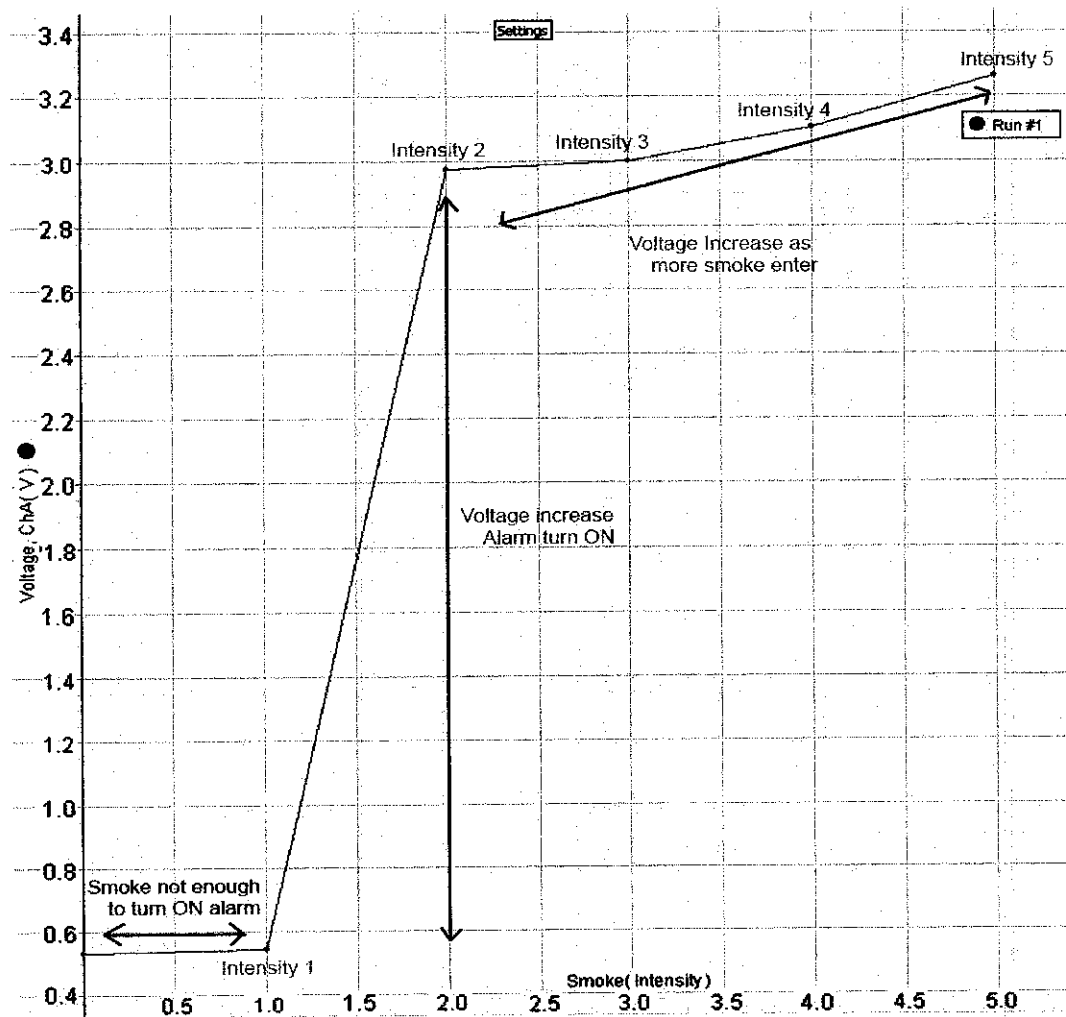

Figure 12 Graph Output Voltage versus Smoke Intensity

Table 1 Table Output Voltage versus Smoke Intensity

| Output Voltage versus Smoke Intensity | |
|--|------------------------|
| Smoke (intensity) | Voltage (V) |
| 0.000 | 0.531 |
| 1.000 | 0.542 |
| 2.000 | 2.976 |
| 3.000 | 3.002 |
| 4.000 | 3.104 |
| 5.000 | 3.263 |

The graph shows that there is a minimum smoke intensity that is allowed to pass through the smoke detector without turn the alarm ON. This would theoretically allow smoke from smoking and cooking condition.

4.2 LCD Display and Keypad

The Microcontroller for the LCD display and keypad is PIC16F1877 microcontroller that is program using a universal device programmer. The LCD and Keypad circuit will be connected to the PIC16F1877 microcontroller as shown in figure 13. From the diagram below, port B is connected to the 2x16 character LCD while port D is connected to the 4x4 keypad.

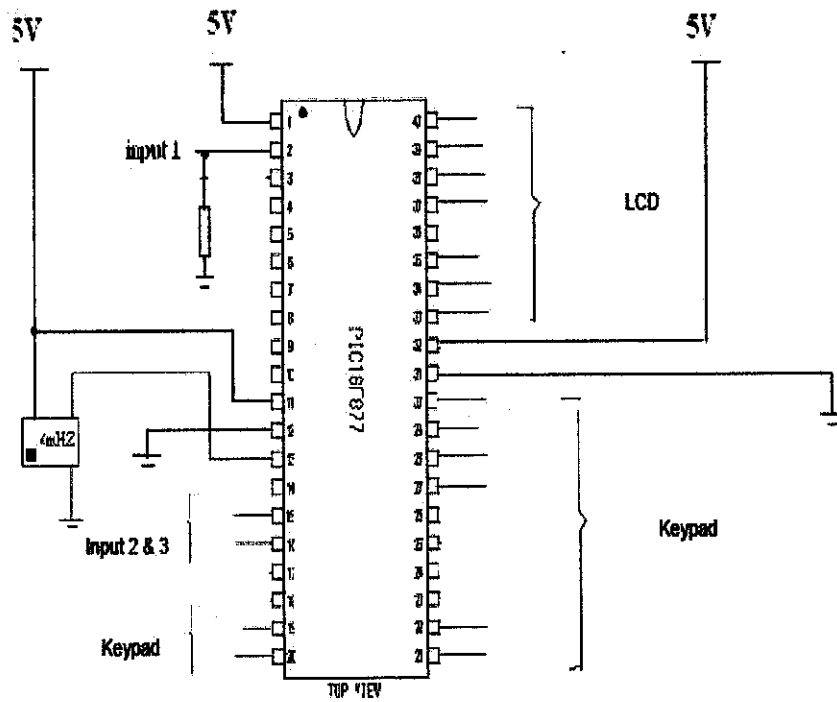

Figure 13 Detailed Connection of PIC16F1877 microcontroller

Refer *Appendix A* for Picture of LCD and Keypad Circuit

Refer *Appendix B* for LCD Display and Keypad Coding

Refer *Appendix C* for PIC16F87X Datasheet

4.3 Temperature Detector Circuit – Testing and Troubleshooting

Figure 14 shows the temperature detector schematic circuit. The circuit consists of two components, a temperature sensor, LM35DZ and a resistor of 910K Ω . After the testing and troubleshooting of the temperature detector circuit the circuit is soldered into Vera board. The circuit then is again tested so that if any error happened during the transfer then it can be detected earlier. The voltage output of the circuit is read between the middle leg of LM35DZ and ground.

condition that could lead to fire. So, the chosen temperature for alarm to turn ON is 40 °C.

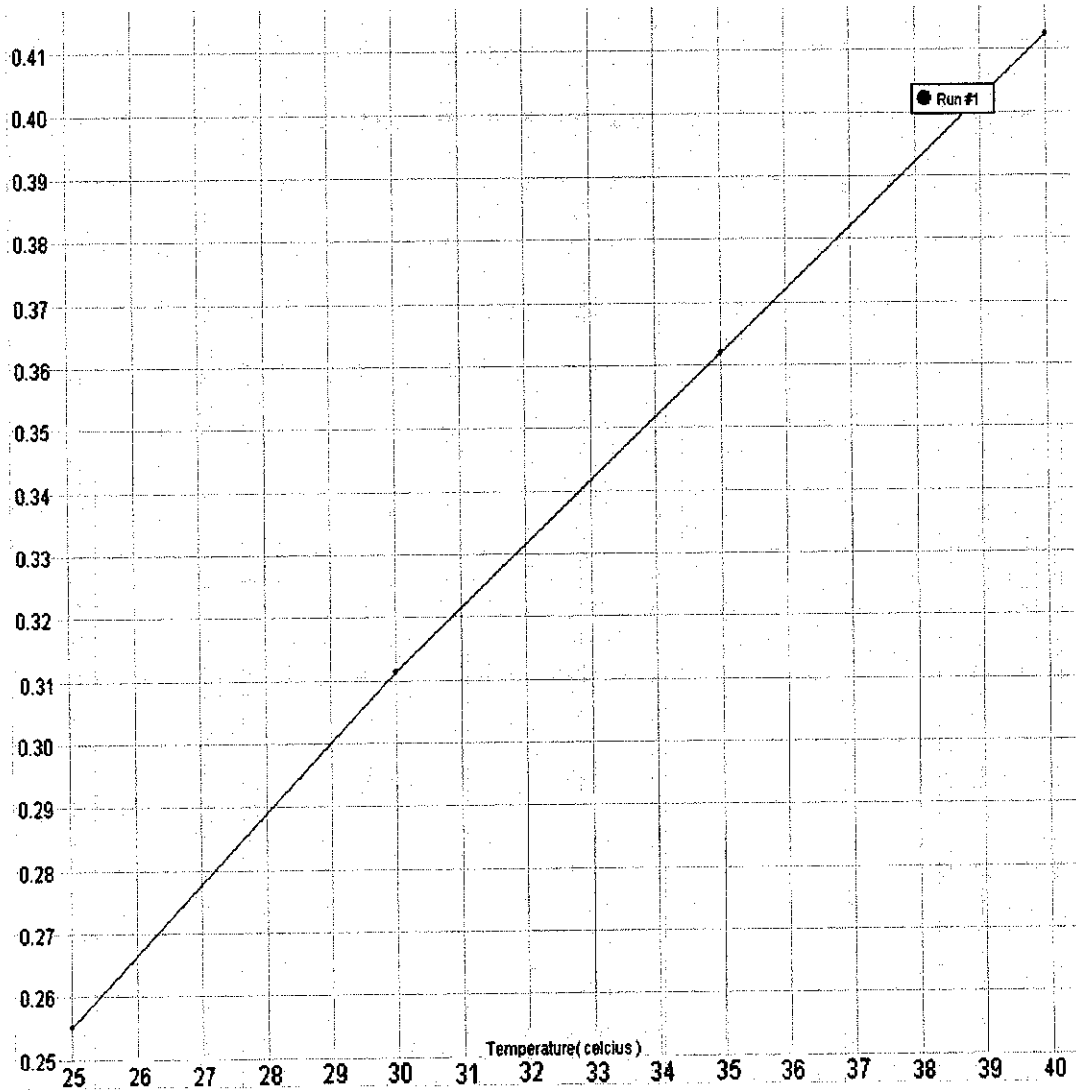

Figure 15 Graph Output Voltage versus Temperature

Table 2 Output Voltage versus Temperature

| Output Voltage versus Temperature | |
|--|------------------------|
| Temperature (Celsius) | Voltage (V) |
| 25.000 | 0.255 |
| 30.000 | 0.311 |
| 35.000 | 0.362 |
| 40.000 | 0.413 |

4.4 Complete Home Security System

Figure 16 shows the complete schematic diagram of home security system. This complete System consists of three sensor circuits, smoke detector circuit, temperature detector circuit and magnetic switch detector circuit interface by a keypad and LCD display. All the sensor circuits then are connected to a phone dialer circuit.

The system works to satisfy both conditions when user is home and when user is not home. The keypad and LCD act as an interface that will allow user to browse menu to see the condition of the circuit. If fire happen or an intruder broke into the house the microcontroller will trigger an alarm and the LCD will display the condition that triggering the alarm.

The phone dialer circuit works when the user is not home. Whenever there is a possible fire or intruder in the house the circuit will dial the user cell phones number as to give precaution to the user. The alarm will also be triggered in this condition. The whole system together makes a home security system.

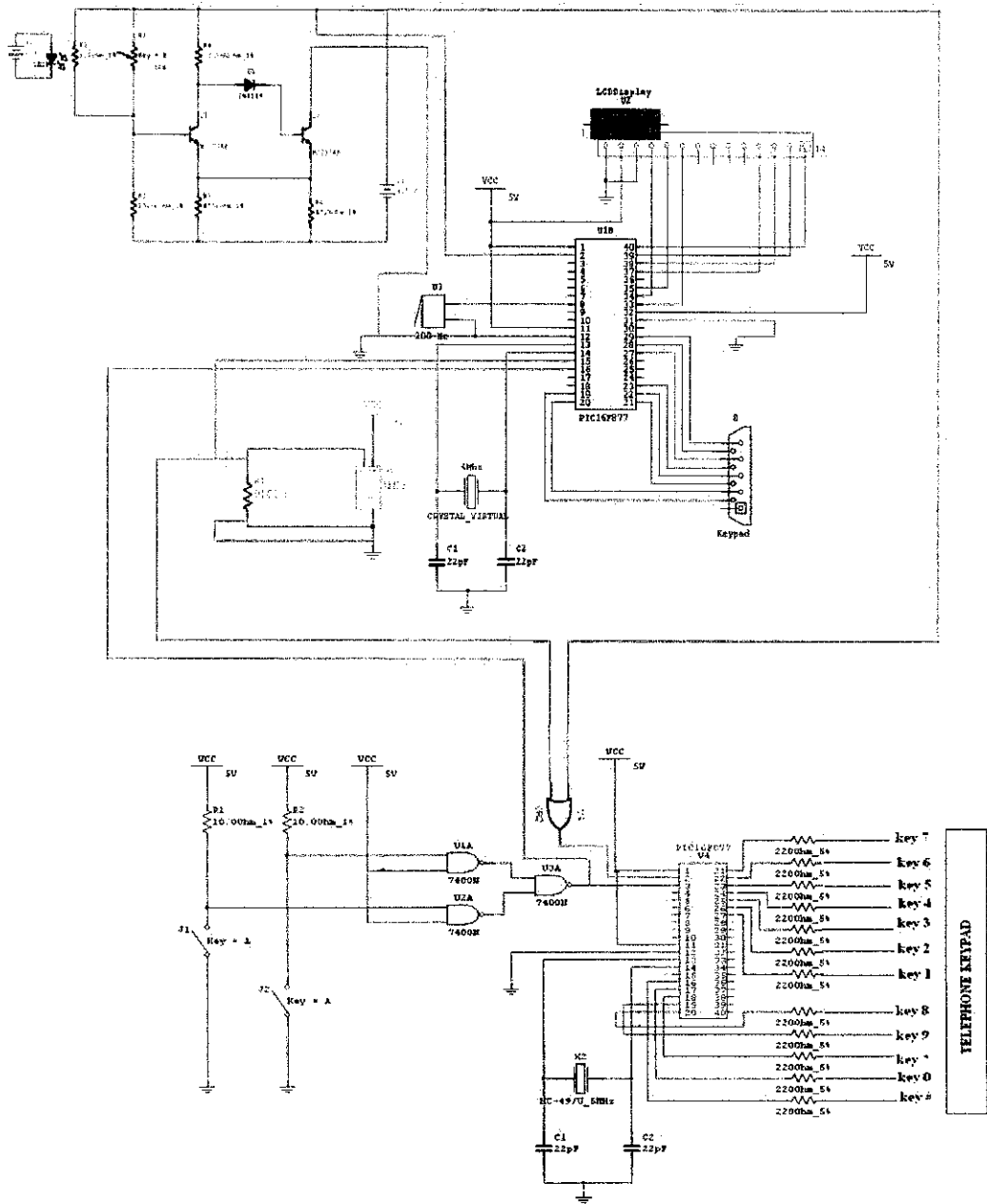

Figure 16 The Complete Home Security System Schematic Diagram

CHAPTER 5

CONCLUSION

5.1 Conclusion

The requirement of this project is to build a home security system that consists of smoke detector circuit, temperature detector circuit and magnetic switch circuit that interface by a keypad and LCD display. This has been achieved by using Peripheral Interface Controller (PIC) Microcontroller as the brain for the project designed.

To make this project possible, the knowledge of programming in C is required as to program the microcontroller. Enhancement in the programming can be done by reading materials and tutorials available on the microcontroller manufacturer websites. They also provide some tips and advices on how their product can be used in the applications.

The smoke detector circuit had been build and the testing had been conducted in the laboratory using the multimeter to inspect on the effect of light to the LDR. The LDR is a light dependent resistor that will change its resistance according to the amount of light falling on it. The temperature detector is an additional sensor that will measure the room temperature by using a temperature sensor, the LM35DZ. It is an integrated circuit sensor that can be used to measure temperature with an electrical output proportional to the temperature (in °C) [6]

The smoke detector, temperature detector and keypad is connected to the LCD display, LED and alarm by using the microcontroller that will be download with command that helps to interpret the input to the output.

The project is completed with system design and prototype of the Home Security System. At the end of the project, better knowledge on smoke detector and temperature detector function and implementation is gained.

Refer *Appendix D* for the Gantt Chart

5.2 Recommendations

There are certain recommendations that need to be highlighted. They are discussed herein below:

1. In future, more circuits can be added to the system as to enhance the security system.
2. The programming can be improved by adding extra function and more complex programming.
3. The circuit can be improved by using a PCB as to make the circuit design more systematic. The troubleshooting problem will be easier if the PCB were utilized for this project.

REFERENCES

Websites:

- [1] www.ci.torrance.ca.us/TFD/6883.htm
- [2] http://dopamine.chem.umn.edu/chempedia/index.php/Smoke_Detectors
- [3] http://en.wikipedia.org/wiki/Smoke_detector
- [4] <http://www.rev-ed.co.uk/docs/axe102CF.pdf>
- [5] <http://fys.kuleuven.be/pradem/software/DsSheet.pdf>
- [6] <http://www.facstaff.bucknell.edu/mastascu/elessonshtml/Sensors/TempLM35.html>

Books:

- [7] Ahmad Majdi Abd Ghani June 2006, *Design of Solid State-Based Thermoelectric Device for Cooling and eating Drinks in a Car.*
- [8] Ong Kee Keong June 2006, *User Programable Robot: Mini Rover For Primary School Student.*
- [9] Nik Othman Bin Mohamed, *Intelligent Monitoring And Controlling For A Parking System (Car Park)*

APPENDICES

APPENDIX A CIRCUIT'S PICTURES



Figure 17 Smoke Detector Circuit

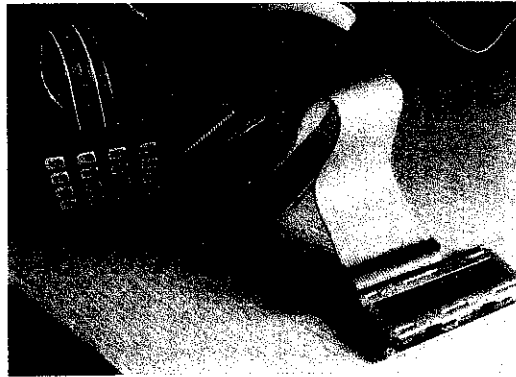

Figure 18 LCD display and Keypad circuit



Figure 19 Temperature Detector Circuit

APPENDIX B LCD AND KEYPAD CODING

```
#include <16F877.h>
#device ADC=8
#fuses XT, NOWDT, NOPROTECT, NOPUT, NOBROWNOUT, NOLVP
#use delay (clock=4000000)
#include <LCD.C>
#include <string.h>
#include <keyy_padd.c>

float adcValue;
float currTemp;
float voltage;
int sum;
char k;
char c;
int i;

void main()
{
    lcd_init();
    setup_adc_ports(ALL_ANALOG);
    setup_adc(ADC_CLOCK_INTERNAL);

    while(true)
    {
        lcd_gotoxy(1,1);
        lcd_putc("Home SEcurity System");
        lcd_gotoxy(1,2);
        lcd_putc("Menu: 1 2 3 F");

        set_adc_channel(0);
        delay_us(30);
```

```

adcValue=read_adc();
voltage = 5.000*adcValue/255.000;
currTemp = voltage/0.01;

for(i=0;i<3;i++)
{
    k = get_key();
    if(k == '1')
    {
        while(1)
        {
            if(adcValue < 17)
            {
                lcd_init();
                lcd_gotoxy(1,1);
                printf(lcd_putc,"%f",currTemp);
                lcd_gotoxy(10,1);
                lcd_putc("deg C");
            }
            else if (adcValue >= 17)
            {
                lcd_init();
                lcd_gotoxy(1,1);
                printf(lcd_putc,"%f",currTemp);

                lcd_gotoxy(10,1);
                lcd_putc("deg C");

                lcd_gotoxy(1,2);
                lcd_putc("1.Fire!! ");
            }

            k = get_key();
            if(k != '1')

```

```

        break;
    }
    lcd_gotoxy(18,2);
    lcd_putc(k);
}
else if(k == '2')
{
while(1)
    {
        if(!input(PIN_C0))
        {
            lcd_init();
            lcd_gotoxy(1,1);
            lcd_putc("No Smoke ");
        }
        else if (input(PIN_C0))
        {
            lcd_init();
            lcd_gotoxy(1,1);
            lcd_putc("2.Fire!! ");
        }

        k = get_key();
        if(k != '2')
            break;
    }
    lcd_gotoxy(18,2);
    lcd_putc(k);
}
else if(k == '3')
{
while(1)
    {

```

```
    }  
  }  
}  
  if(adcValue < 17 && (!input(PIN_C0)) && (!input(PIN_C1)))  
    output_high(pin_E1);  
    else  
    output_high(pin_E0);  
  
}  
}
```

APPENDIX C PIC16F87X DATASHEET



PIC16F874A/877A

40-Pin Enhanced FLASH Microcontroller Product Brief

High Performance RISC CPU:

- Only 35 single word instructions to learn
- All single cycle instructions except for program branches, which are two cycle
- Operating speed: DC - 20 MHz clock input
DC - 260 ns instruction cycle
- Up to 8K x 14 words of FLASH Program Memory,
Up to 388 x 8 bytes of Data Memory (RAM),
Up to 256 x 8 bytes of EEPROM data memory
- Pinout compatible to other 40-pin PIC16CXXX and PIC16FXXX microcontrollers

Peripheral Features:

- Timer0 module: 8-bit timer/counter with 8-bit prescaler
- Timer1 module: 16-bit timer/counter with prescaler, can be incremented during SLEEP via external crystal/clock
- Timer2 module: 8-bit timer/counter with 8-bit period register, prescaler and postscaler
- Two Capture, Compare, PWM modules
- Master Synchronous Serial Port (MSSP) module.
Two modes of operation:
 - 3-wire SPI™ (supports all 4 SPI modes)
 - I²C™ Master and Slave mode
- Addressable USART module:
 - Supports interrupt on Address bit
- Parallel Slave Port (PSP) module 8-bits wide, external RD, WR and CS controls
- High Sink/Source Current: 25 mA

Analog Features:

- 10-bit 8-ch Analog-to-Digital Converter (A/D)
- Brown-out Reset (BOR)
- Analog Comparator module with:
 - Two analog comparators
 - Programmable on-chip voltage reference (VREF) module
 - Programmable input multiplexing from device inputs and internal voltage reference
 - Comparator outputs are externally accessible

Pin Diagram:

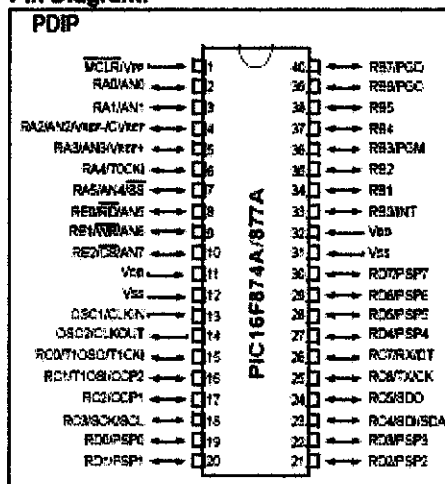

CMOS Technology:

- Low power, high speed FLASH/EEPROM technology
- Fully static design
- Wide operating voltage range (2.0V to 5.5V)
- Commercial and Industrial temperature ranges
- Low power consumption

Special Microcontroller Features:

- 100,000 erase/write cycle Enhanced FLASH program memory typical
- 1,000,000 erase/write cycle Data EEPROM memory typical
- Data EEPROM Retention > 40 years
- Self reprogrammable under software control
- In-Circuit Serial Programming™ (ICSP™) via two pins
- Single supply 5V In-Circuit Serial Programming
- Watchdog Timer (WDT) with its own on-chip RC oscillator for reliable operation
- Programmable code protection
- Power saving SLEEP mode
- Selectable oscillator options
- In-Circuit Debug (ICD) via two pins

| Device | Program Memory | | Data SRAM (Bytes) | EEPROM (Bytes) | I/O | 10-bit A/D (ch) | CCP (PWM) | MSSP | | USART | Timers 8/16-bit | Comparators |
|------------|----------------|----------------------------|-------------------|----------------|-----|-----------------|-----------|------|-------------------------|-------|-----------------|-------------|
| | Bytes | # Single Word Instructions | | | | | | SPI | Master I ² C | | | |
| PIC16F874A | 7.2K | 4096 | 192 | 128 | 33 | 8 | 2 | Yes | Yes | Yes | 2 / 1 | 2 |
| PIC16F877A | 14.3K | 8192 | 368 | 256 | 33 | 8 | 2 | Yes | Yes | Yes | 2 / 1 | 2 |

APPENDIX D GANTT CHART

| Activities | Time | Week | | | | | | | | | | | | | |
|--|------|------|---|---|---|---|---|---|---|---|----|----|----|----|------|
| | | 1 | 2 | 3 | 4 | 5 | 6 | 7 | 8 | 9 | 10 | 11 | 12 | 13 | 14++ |
| Smoke Detector Testing and Troubleshooting | | █ | █ | █ | █ | | | | | | | | | | |
| Temperature Detector Troubleshooting | | | | | | █ | █ | █ | | | | | | | |
| Keypad and LCD Troubleshooting | | | | | | █ | █ | █ | █ | | | | | | |
| Keypad and LCD Programming | | | | | | | | █ | █ | █ | | | | | |
| Testing and Troubleshooting the whole system | | | | | | | | | | █ | █ | █ | | | |
| Sample Home Development | | | | | | | | | | | █ | █ | █ | █ | |
| Oral Presentation | | | | | | | | | | | | | | | █ |
| Final Report Submission | | | | | | | | | | | | | | | █ |